



US00D332020S

United States Patent [19]

[11] Patent Number: **Des. 332,020**

Hollington

[45] Date of Patent: **** Dec. 29, 1992**

[54] FURNITURE LEG

DESCRIPTION

- [75] Inventor: **Geoffrey A. Hollington**, London, England
- [73] Assignee: **Herman Miller, Inc.**, Zeeland, Mich.
- [**] Term: **14 Years**
- [21] Appl. No.: **495,302**
- [22] Filed: **Mar. 19, 1990**
- [52] U.S. Cl. **D6/495; D6/498**
- [58] Field of Search **D6/480, 482-489, D6/495, 496, 498, 499, 397, 366; 248/188.7; 297/445, 447**

FIG. 1 is a perspective view of a furniture leg, showing my new design;
 FIG. 2 is a side elevational view thereof;
 FIG. 3 is an end elevational view thereof;
 FIG. 4 is an elevational view, showing the end not shown in FIG. 3;
 FIG. 5 is a side elevational view, showing the side not shown in FIG. 2;
 FIG. 6 is a top plan view thereof;
 FIG. 7 is a bottom plan view thereof;
 FIG. 8 is a side elevational view of a furniture leg, showing a second embodiment of my new design;
 FIG. 9 is an end elevational view thereof;
 FIG. 10 is a top plan view thereof;
 FIG. 11 is a bottom plan view thereof;
 FIG. 12 is a perspective view of a furniture leg, showing a third embodiment of my new design;
 FIG. 13 is a side elevational view thereof;
 FIG. 14 is an end elevational view thereof;
 FIG. 15 is an elevational view, showing the end not shown in FIG. 14;
 FIG. 16 is a side elevational view, showing the side not shown in FIG. 13;
 FIG. 17 is a top plan view thereof;
 FIG. 18 is a bottom plan view thereof;
 FIG. 19 is a side elevational view of a furniture leg, showing a fourth embodiment of my new design;
 FIG. 20 is an end elevational view thereof;
 FIG. 21 is a top plan view thereof;
 FIG. 22 is a bottom plan view thereof;
 FIG. 23 is a perspective view of a furniture leg, showing a fifth embodiment of my new design;
 FIG. 24 is a side elevational view thereof;
 FIG. 25 is an end elevational view thereof;
 FIG. 26 is a elevational view, showing the end not shown in FIG. 25;
 FIG. 27 is a elevational view, showing the side not shown in FIG. 24;
 FIG. 28 is a top plan view thereof;
 FIG. 29 is a bottom plan view thereof;
 FIG. 30 is a side elevational view of a furniture leg, showing a sixth embodiment of my new design;
 FIG. 31 is an end elevational view thereof;
 FIG. 32 is a top plan view thereof; and,
 FIG. 33 is a bottom plan view thereof.

[56] **References Cited**
U.S. PATENT DOCUMENTS

D. 141,889	7/1945	Loman .	
D. 169,261	4/1953	Keal .	
D. 171,891	4/1954	Hamilton .	
D. 219,820	2/1971	Wegner .	
D. 227,830	7/1973	Klose .	
D. 227,831	7/1973	Andrus et al. .	
D. 234,382	2/1975	Tacke .	
D. 236,061	7/1975	Tacke .	
D. 249,405	9/1978	Ambasz .	
D. 267,384	12/1982	Fauli	D6/498
D. 273,730	5/1984	Cafiero .	
D. 284,434	7/1986	Boundy	D6/498
D. 295,594	5/1988	du Reés	D6/466
2,690,366	9/1954	Kimmel .	
4,129,278	12/1978	Bressler	248/188.7 X
4,763,866	8/1988	Sinchok	248/188.7
4,984,761	1/1991	Chen	248/188.7

Primary Examiner—Nelson C. Holtje
Assistant Examiner—Janice E. Seeger
Attorney, Agent, or Firm—Varnum, Riddering, Schmidt & Howlett

[57] CLAIM

The ornamental design for a furniture leg, as shown and described.

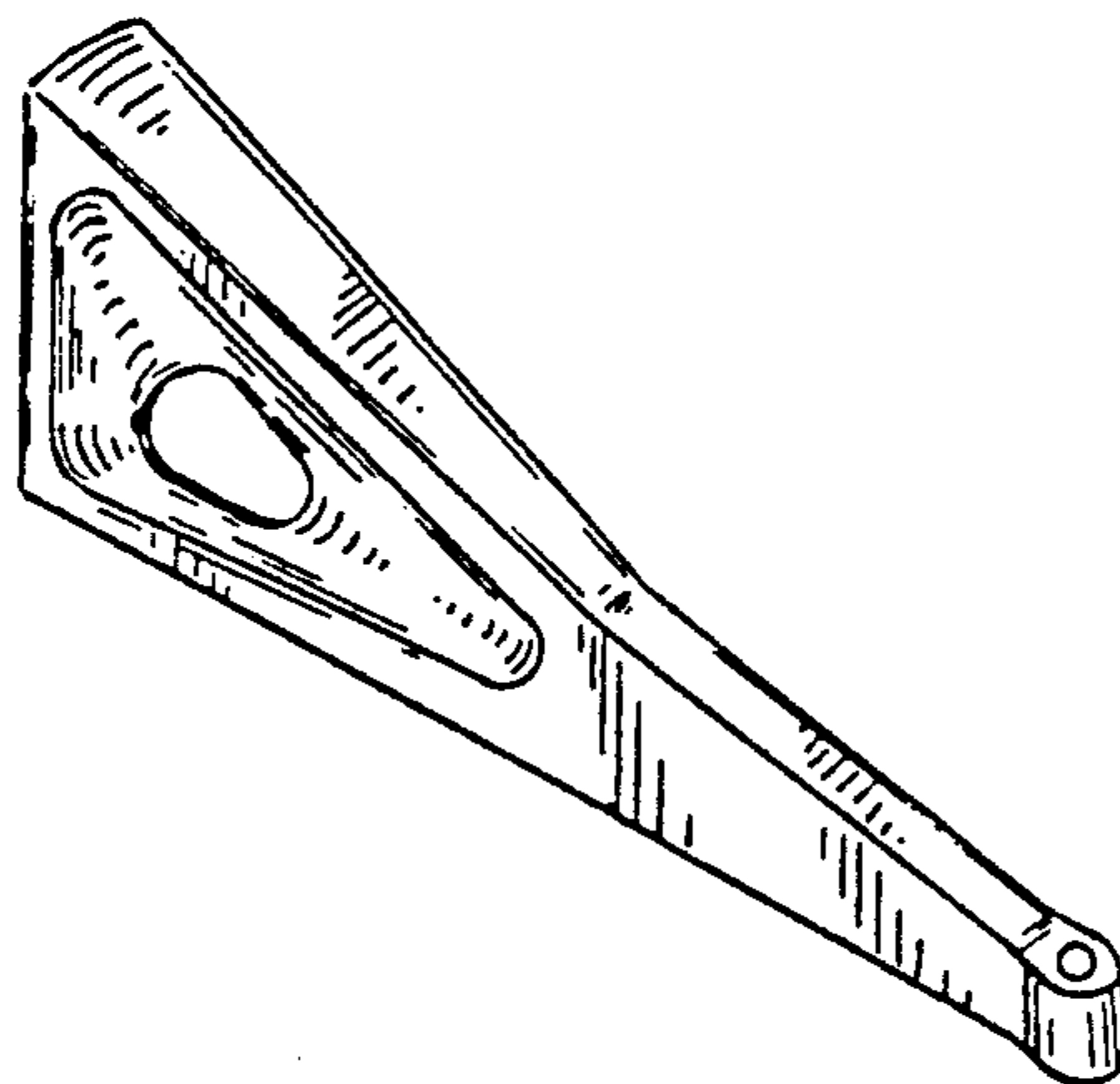

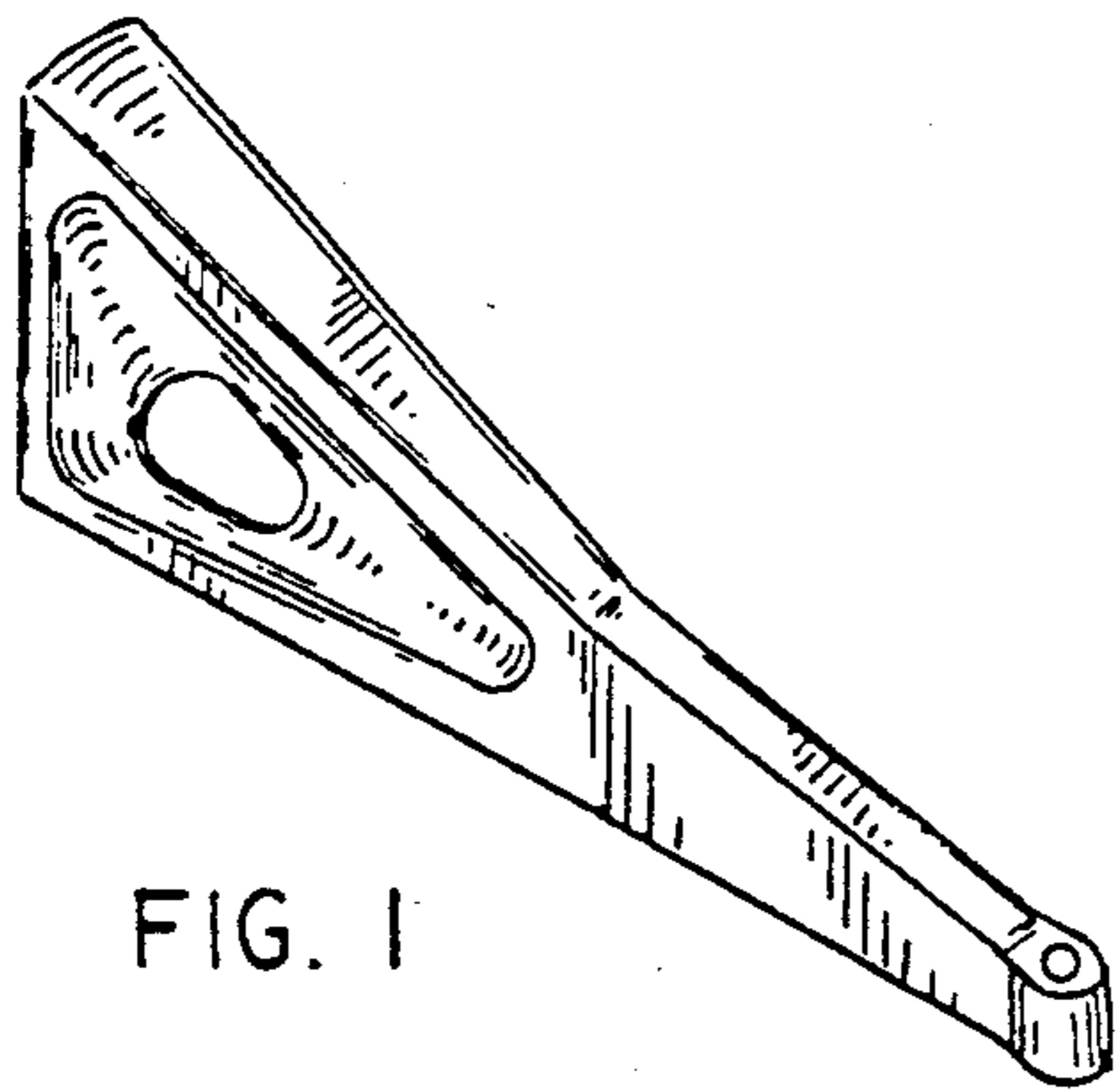

FIG. 1

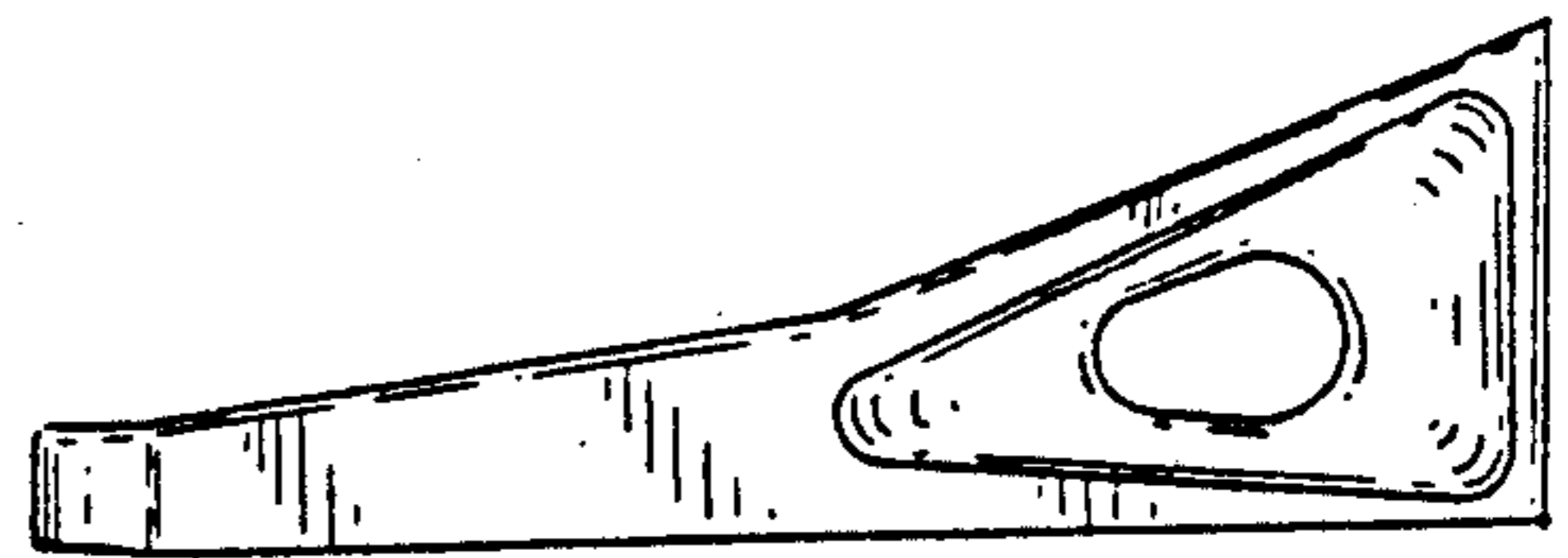

FIG. 2

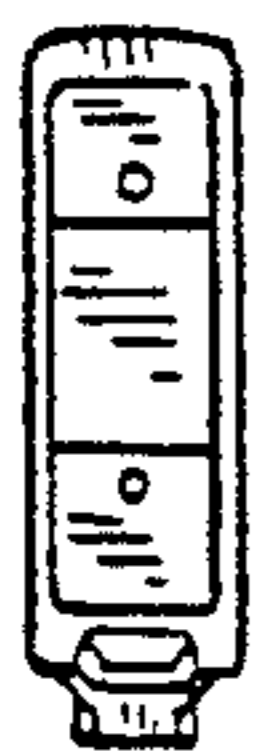

FIG. 3



FIG. 4

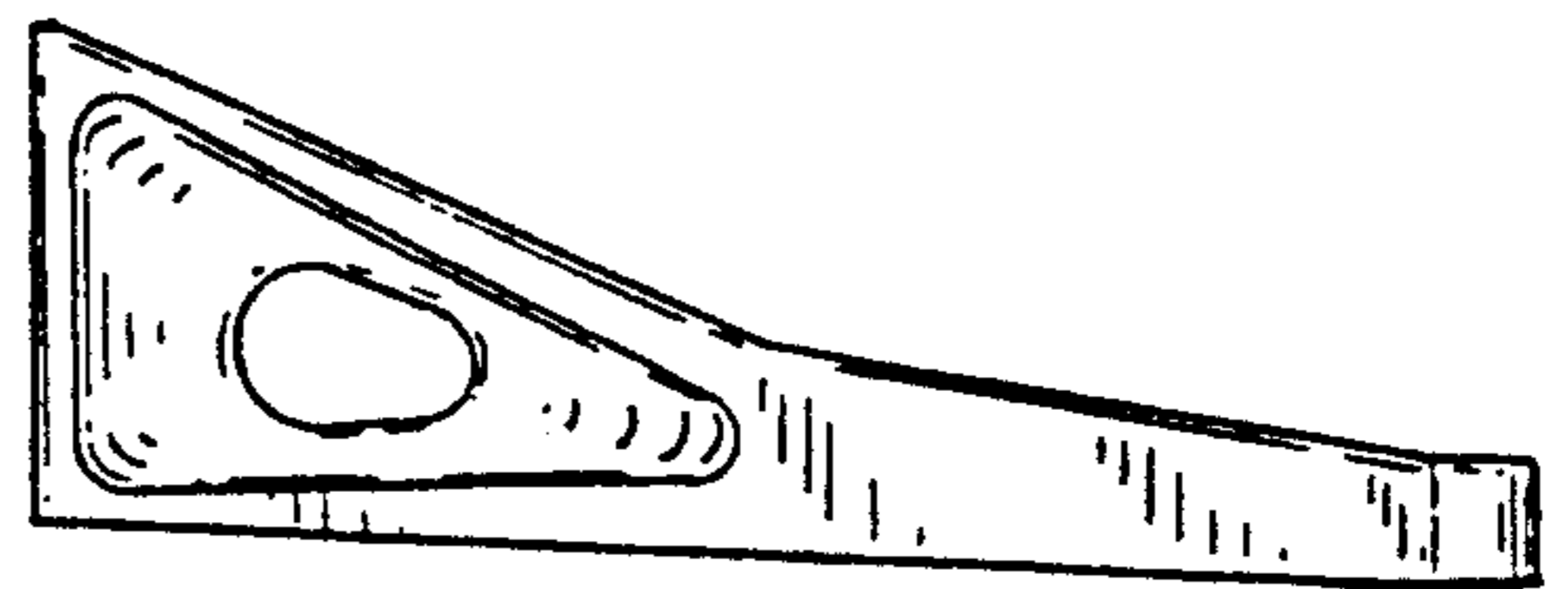

FIG. 5

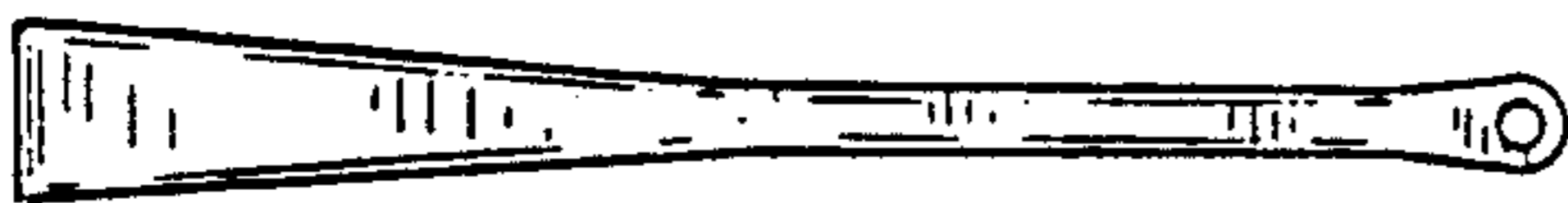

FIG. 6

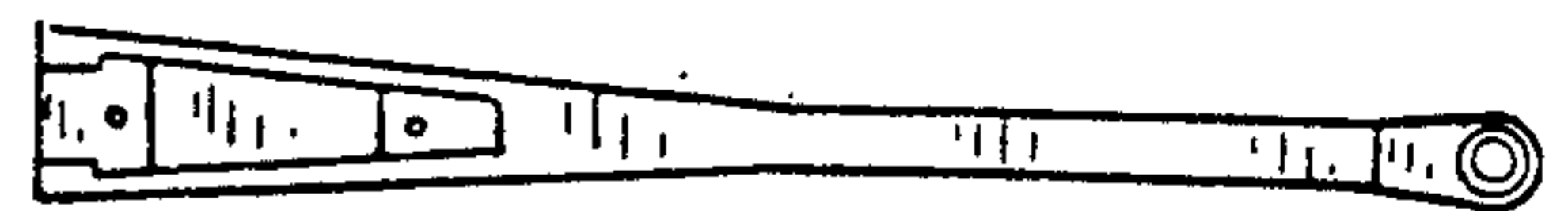

FIG. 7

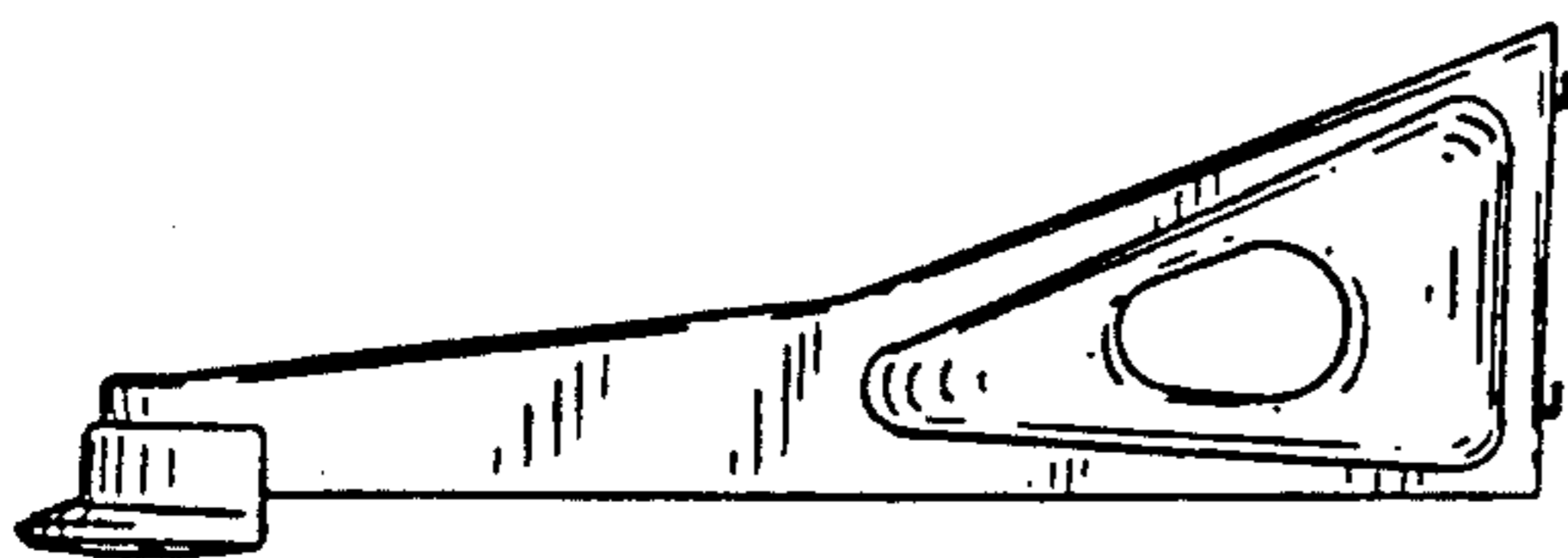

FIG. 8

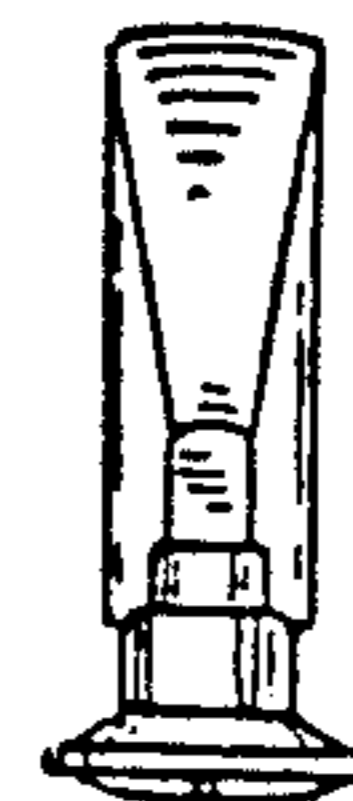

FIG. 9

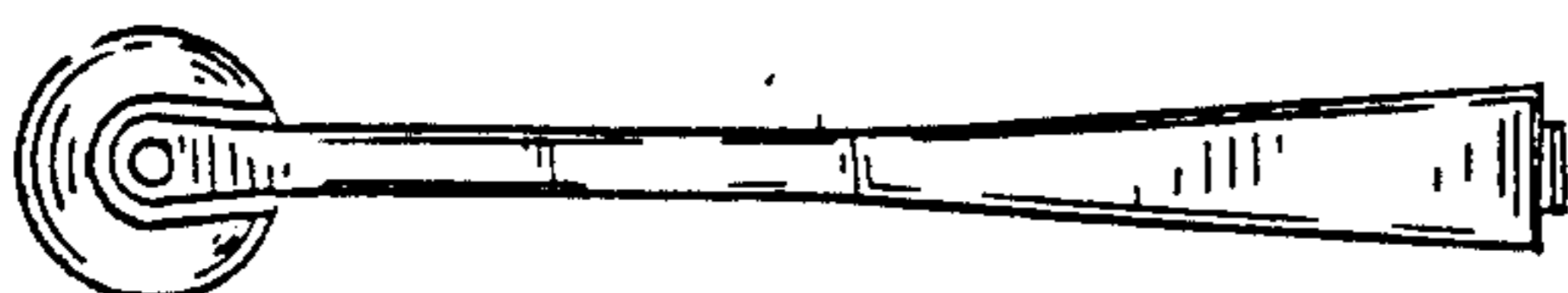

FIG. 10

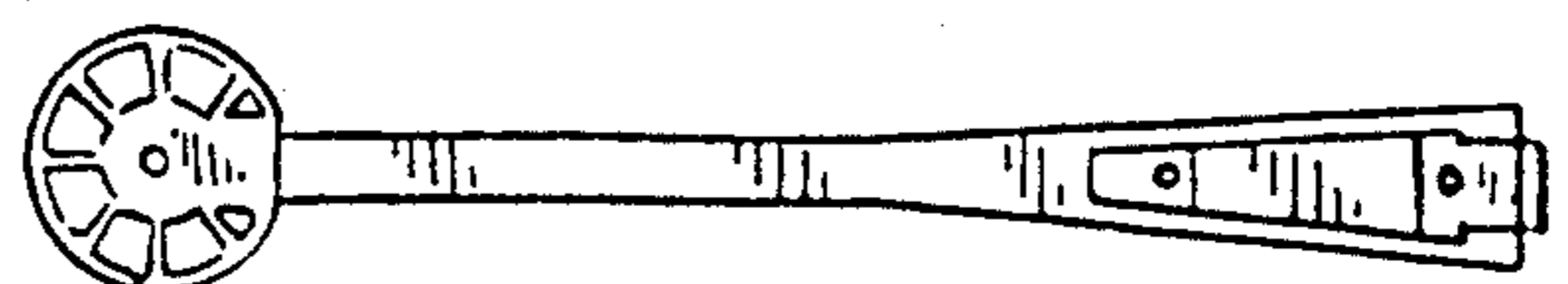

FIG. 11

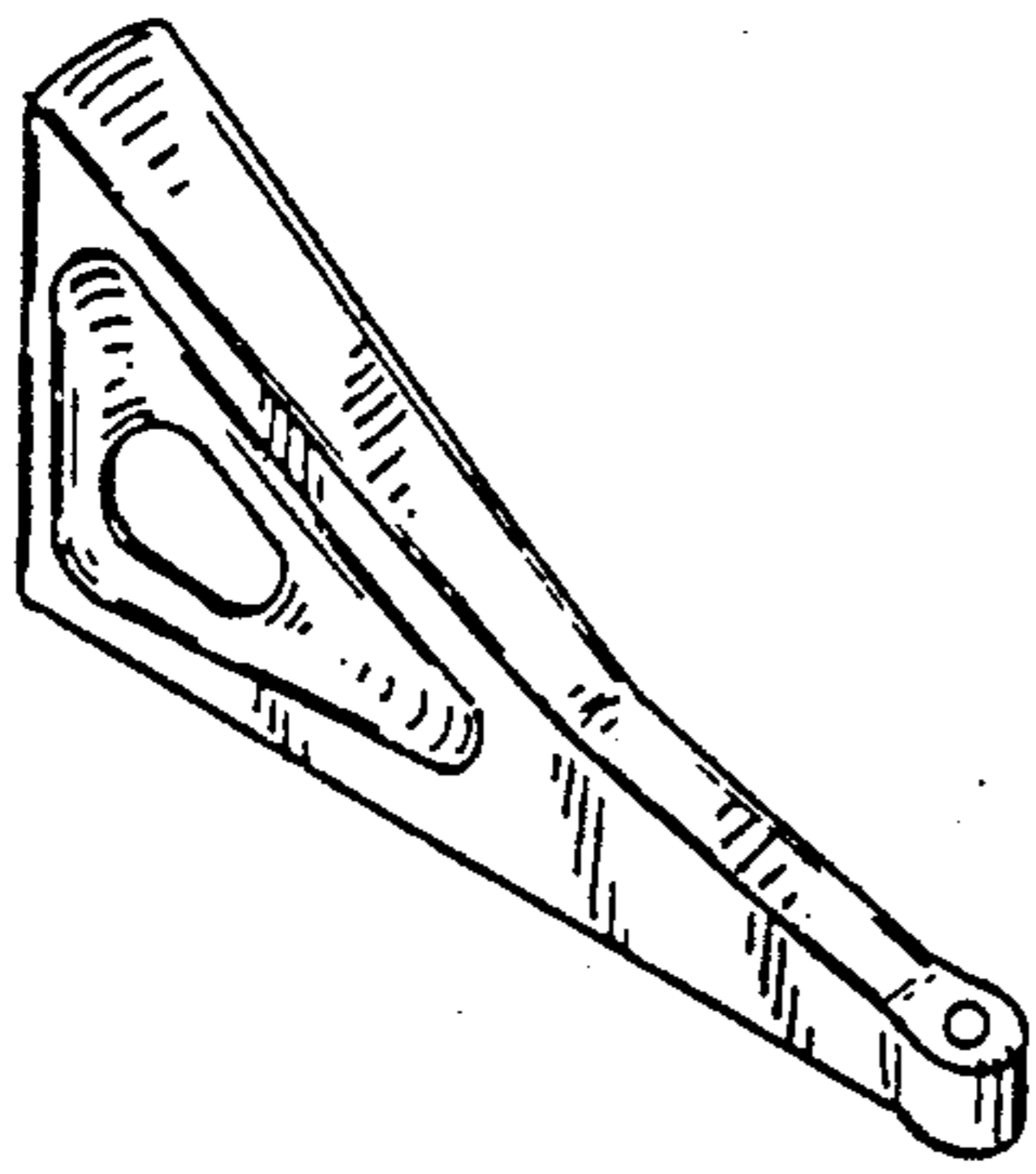

FIG. 12

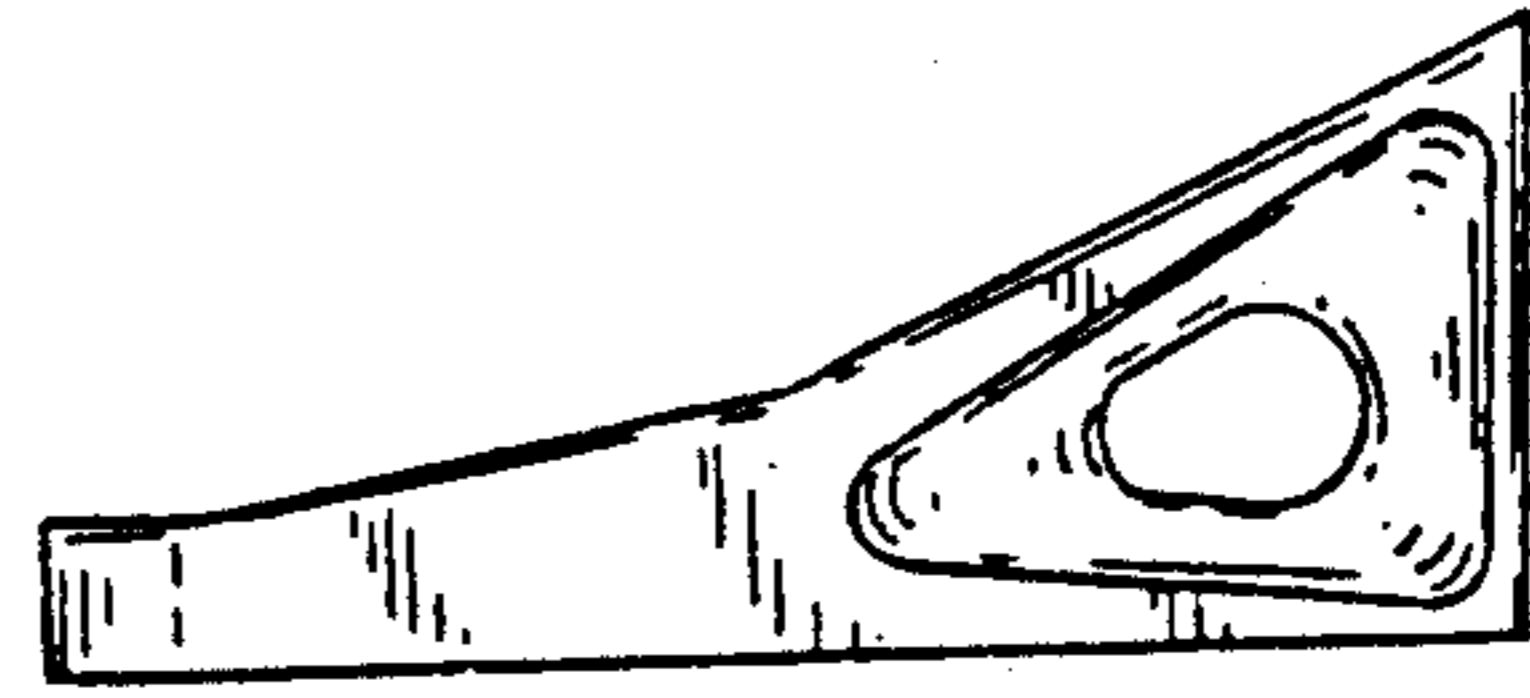

FIG. 13

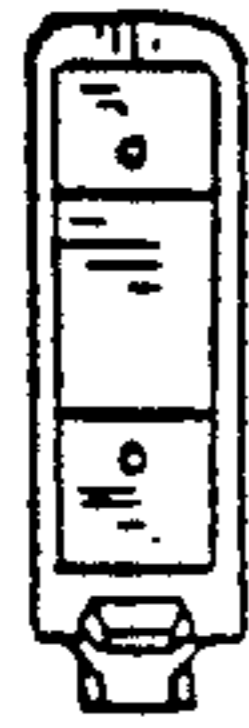

FIG. 14



FIG. 15

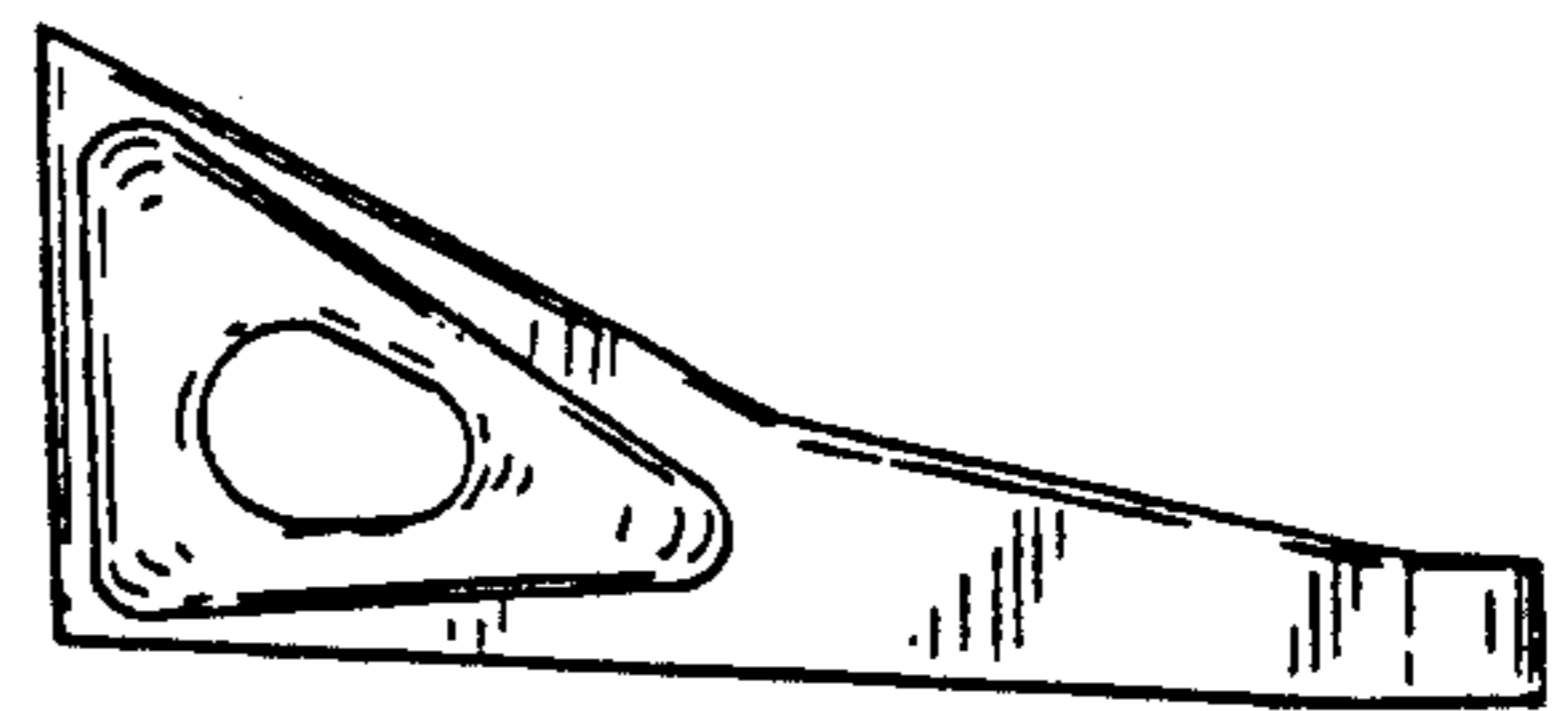

FIG. 16

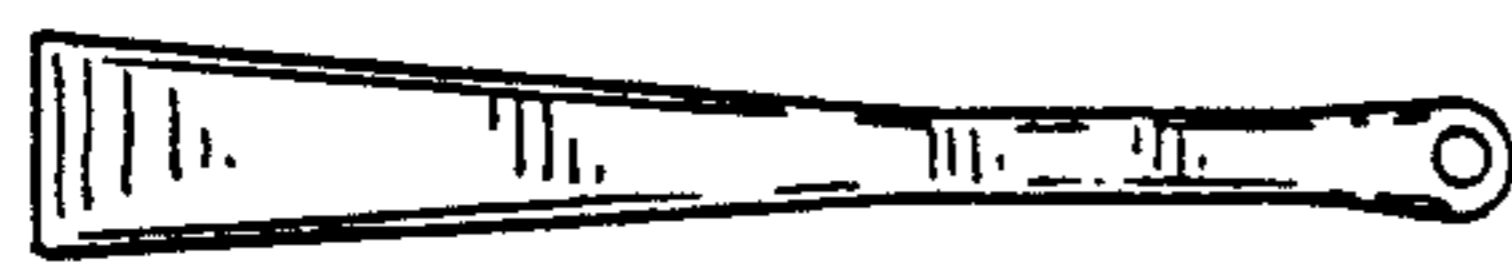

FIG. 17

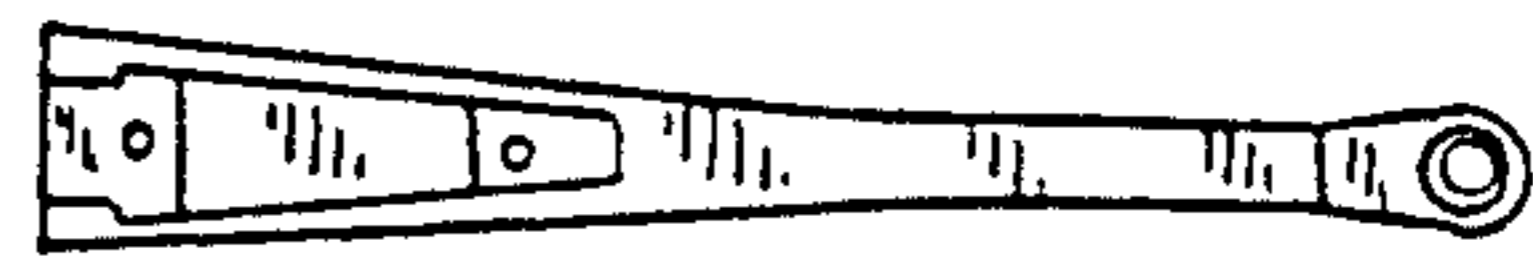

FIG. 18

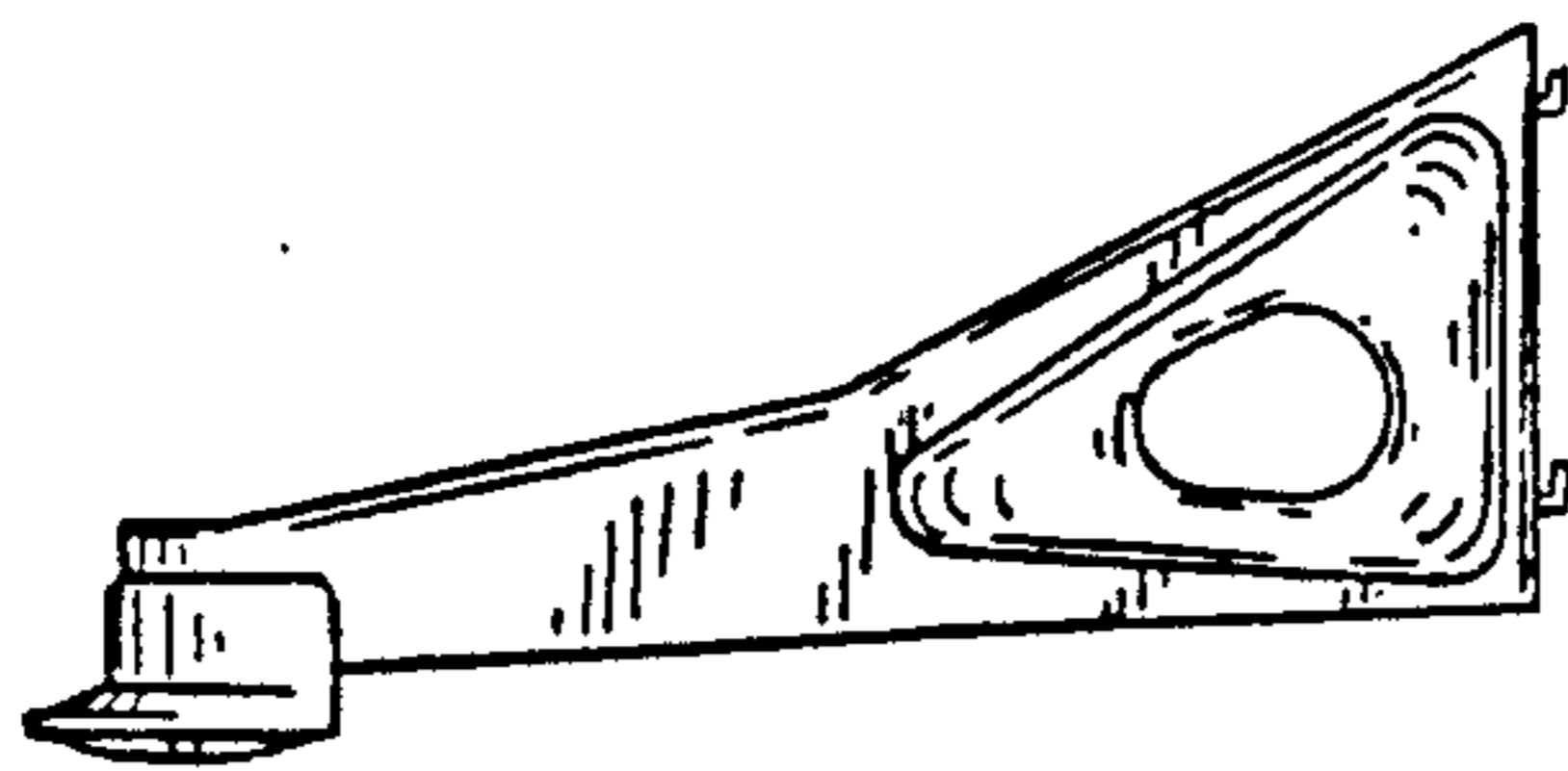

FIG. 19

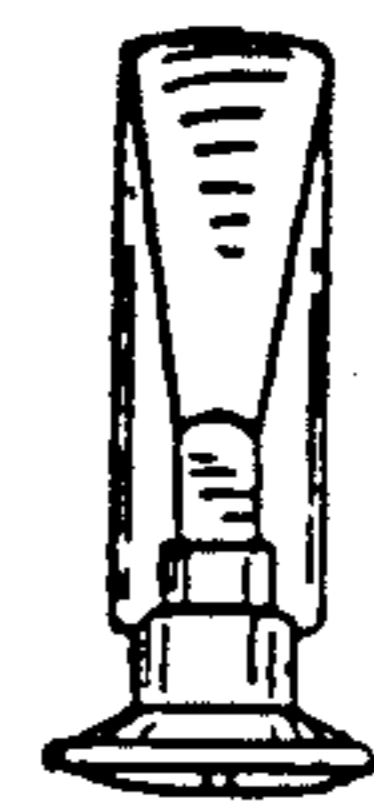

FIG. 20

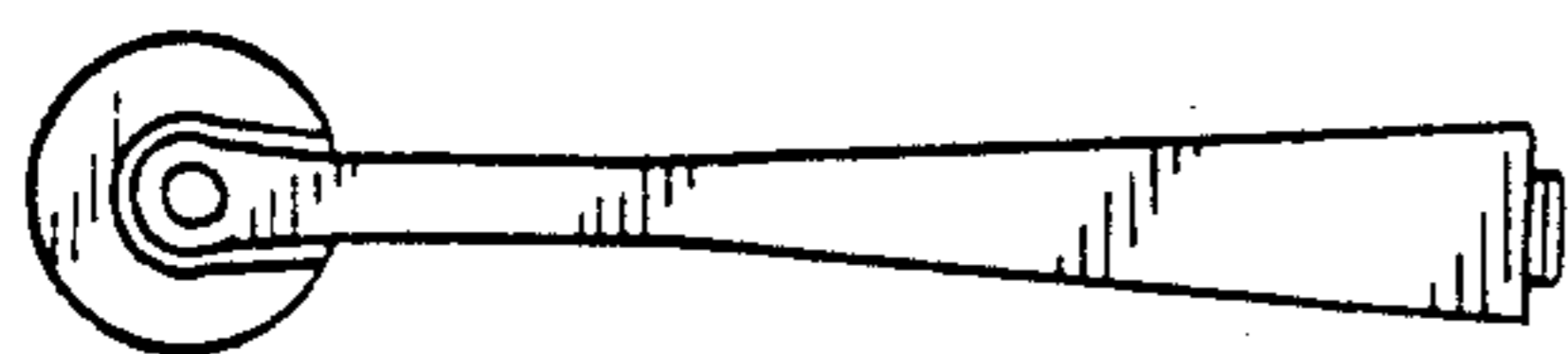

FIG. 21



FIG. 22

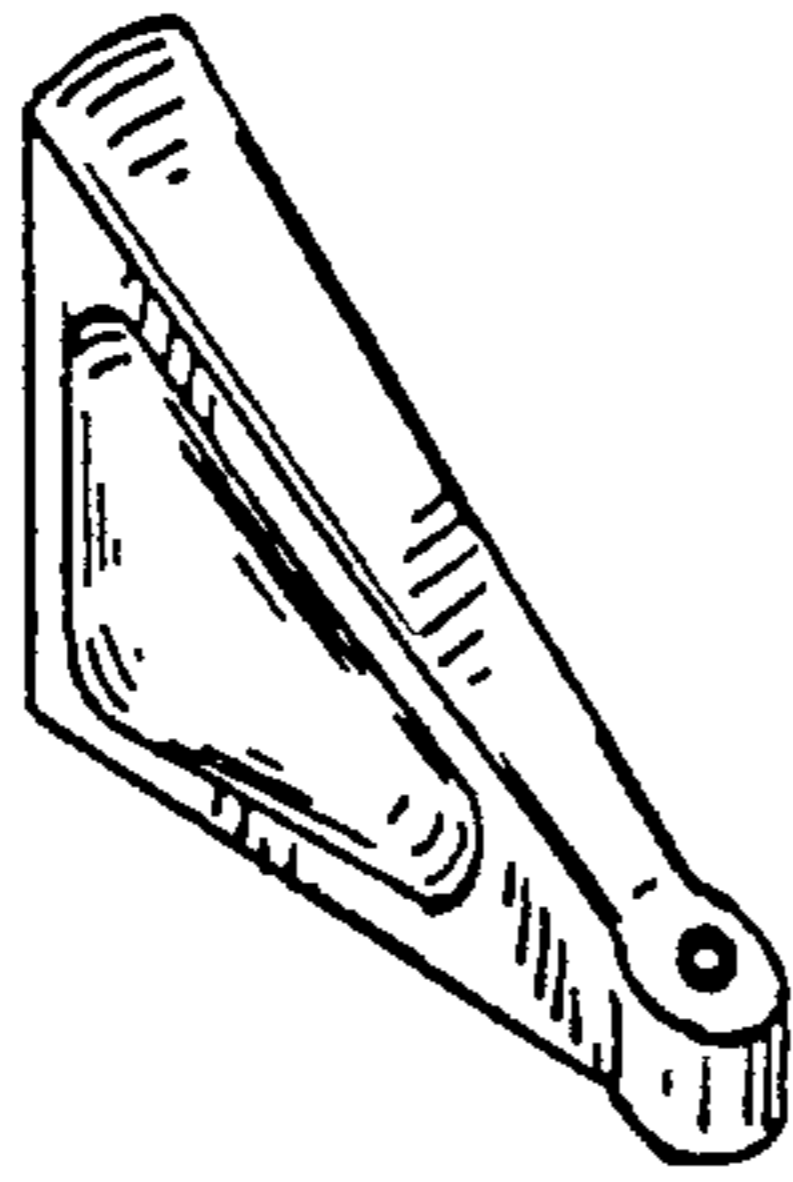

FIG. 23

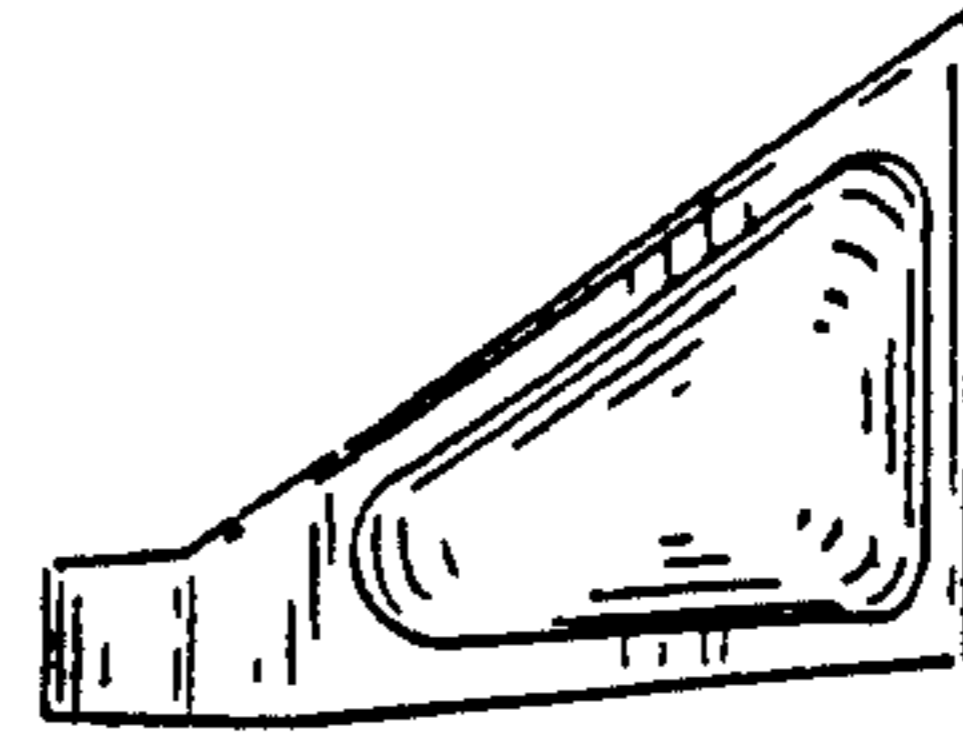

FIG. 24

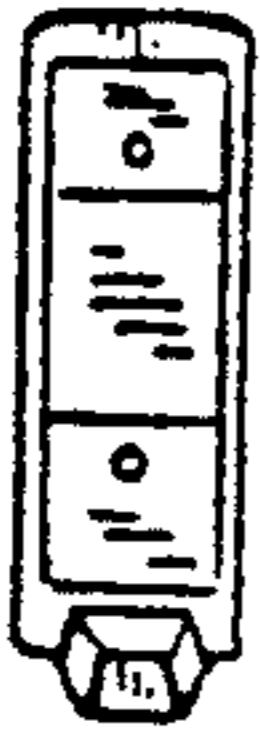

FIG. 25



FIG. 26

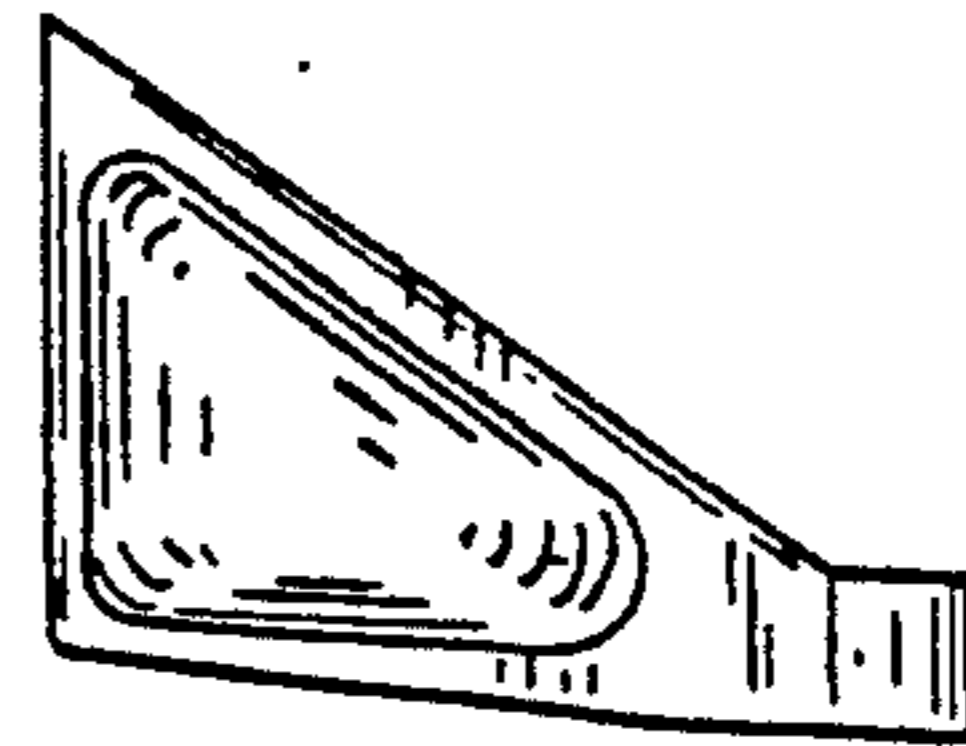

FIG. 27



FIG. 28

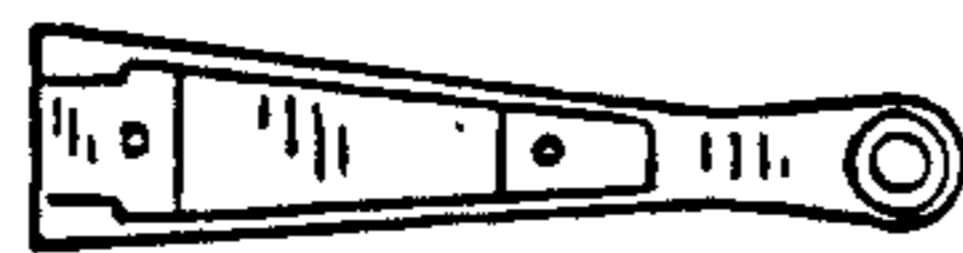

FIG. 29

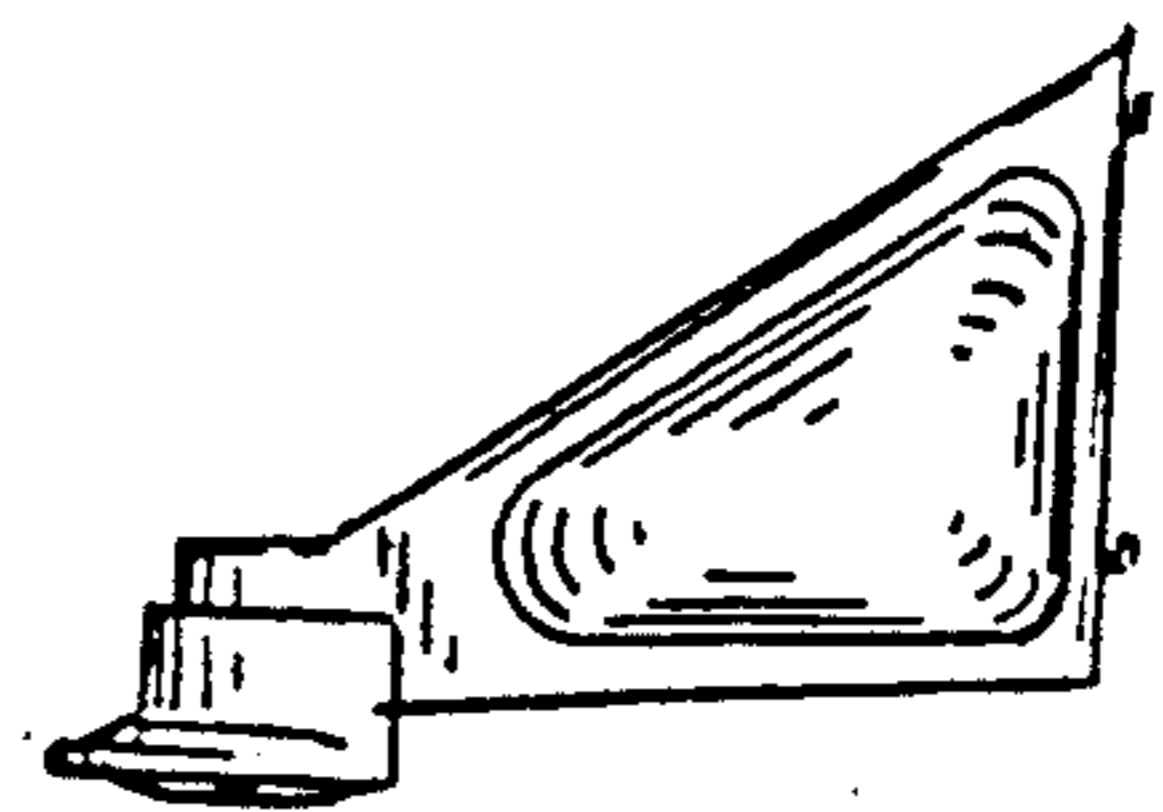

FIG. 30

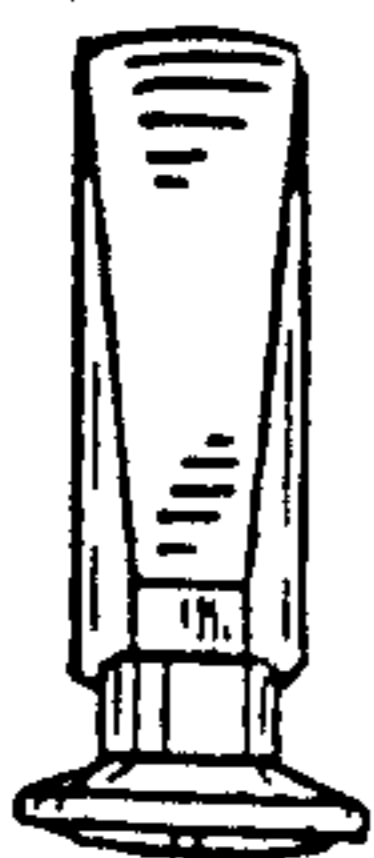

FIG. 31

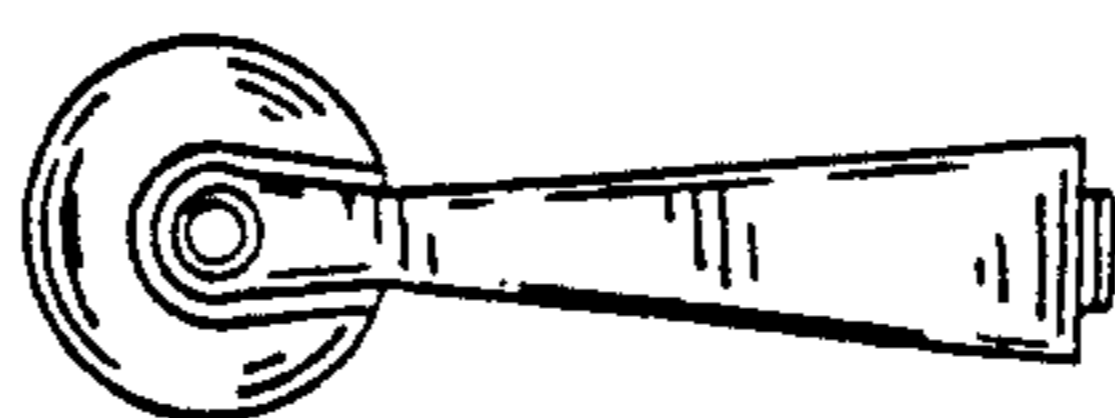

FIG. 32

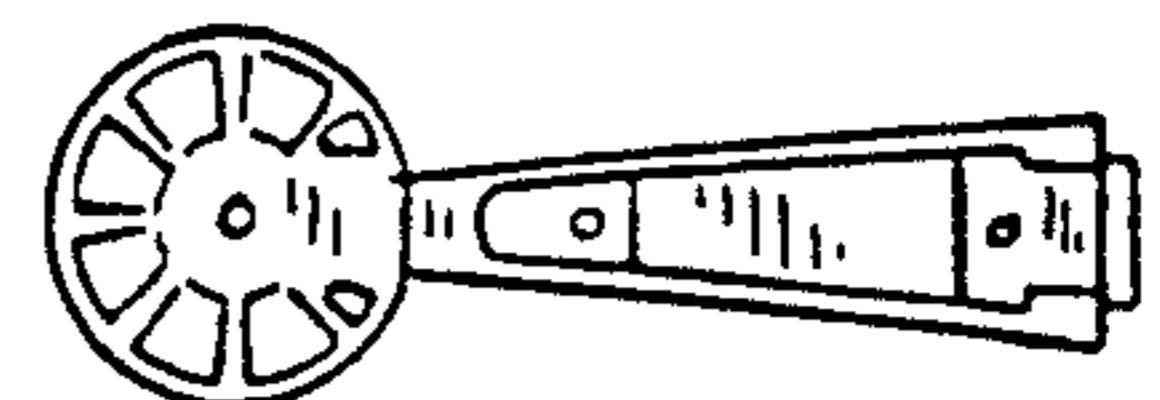

FIG. 33