



US00D331965S

# United States Patent [19]

[11] Patent Number: **Des. 331,965**

Sauter et al.

[45] Date of Patent: **\*\* Dec. 22, 1992**

- [54] SINK
- [75] Inventors: **Bruce M. Sauter**, Schaumburg, Ill.;  
**Raymond A. Dickson, Jr.**, Searcy, Ark.
- [73] Assignee: **Kohler Co.**, Kohler, Wis.
- [\*\*] Term: **14 Years**
- [21] Appl. No.: **481,476**
- [22] Filed: **Feb. 20, 1990**
- [52] U.S. Cl. .... **D23/287; D23/290**
- [58] Field of Search ..... **D23/271-274, D23/284-294; 4/619, 625-642, 652, 654, 665**

[56] **References Cited**

**U.S. PATENT DOCUMENTS**

D. 193,464	8/1962	Hauser .....	D23/290
D. 198,305	6/1964	Graning, Jr. ....	D23/290
D. 259,439	6/1981	Doman .....	D23/287
D. 293,814	1/1988	Muck et al. ....	D23/287
D. 298,163	10/1988	Downs .....	D23/287
D. 319,870	9/1991	Goeke et al. ....	D23/287
4,624,020	11/1986	Abderhalden et al. ....	4/639 X
4,689,840	9/1987	Muck et al. ....	4/629
4,847,927	7/1989	Blanc .....	4/629

**OTHER PUBLICATIONS**

Domestic Engineering, Apr. 1989, p. 62.  
Page from a Franke brochure showing the CP630, CP670, and CP671 sinks, undated, admitted prior art.  
Page 8 of an Elkay advertisement, undated, admitted prior art, showing the LCR-4322-C sink.  
May 1988 Sterling advertisement for the model 432-5 sink.  
Jacob Delafon advertisement, undated, admitted prior art, showing the "Dessins Et Cotes" sink 741.

Jacob Delafon advertisement, undated, admitted prior art, showing the "Dessins Et Cotes" sink 814.  
Page 6 of an Elkay advertisement entitled "The Traditional Gourmet Line", undated, admitted prior art.

*Primary Examiner*—James R. Largen  
*Attorney, Agent, or Firm*—Quarles & Brady

[57] **CLAIM**

The ornamental design for a sink, as shown and described.

**DESCRIPTION**

FIG. 1 is a perspective view taken from the top, front and right side of a sink showing our new design;  
FIG. 2 is a top plan view thereof;  
FIG. 3 is a cross-sectional view taken on line 3—3 of FIG. 2;  
FIG. 4 is a cross-sectional view taken on line 4—4 of FIG. 2;  
FIG. 5 is a cross-sectional view taken on line 5—5 of FIG. 2;  
FIG. 6 is an enlarged cross-sectional view taken on line 6—6 of FIG. 2;  
FIG. 7 is a top plan view of a second embodiment thereof;  
FIG. 8 is a perspective view taken from the top, front and right side of a third embodiment thereof;  
FIG. 9 is a top plan view of FIG. 8;  
FIG. 10 is a cross-sectional view taken on line 10—10 of FIG. 9;  
FIG. 11 is a cross-sectional view taken on line 11—11 of FIG. 9; and,  
FIG. 12 is a cross-sectional view taken on line 12—12 of FIG. 9.  
The fragmentary broken line representations of countertops in FIGS. 1 and 8 are for the purpose of illustration only and form no part of the claimed design.

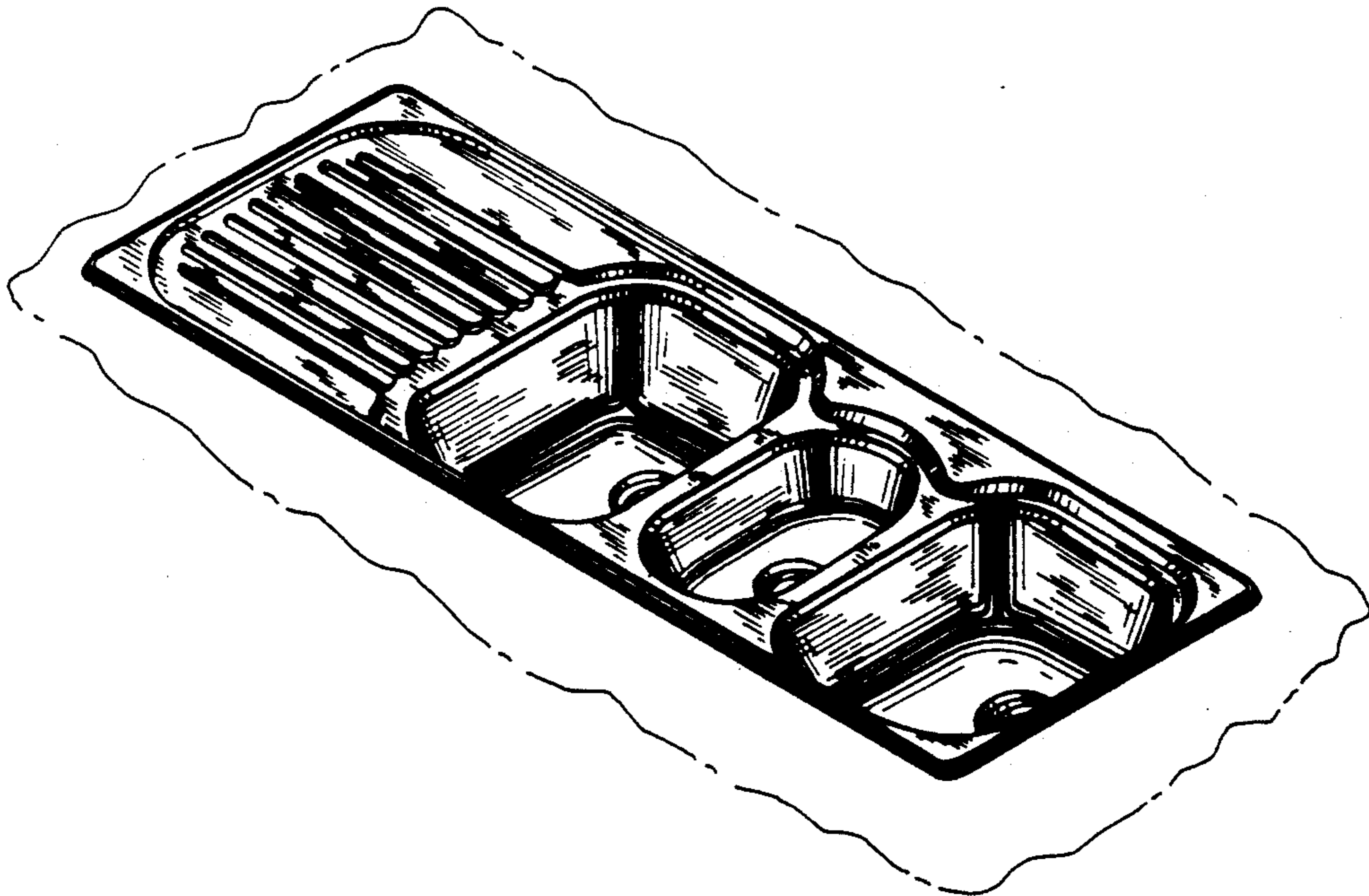

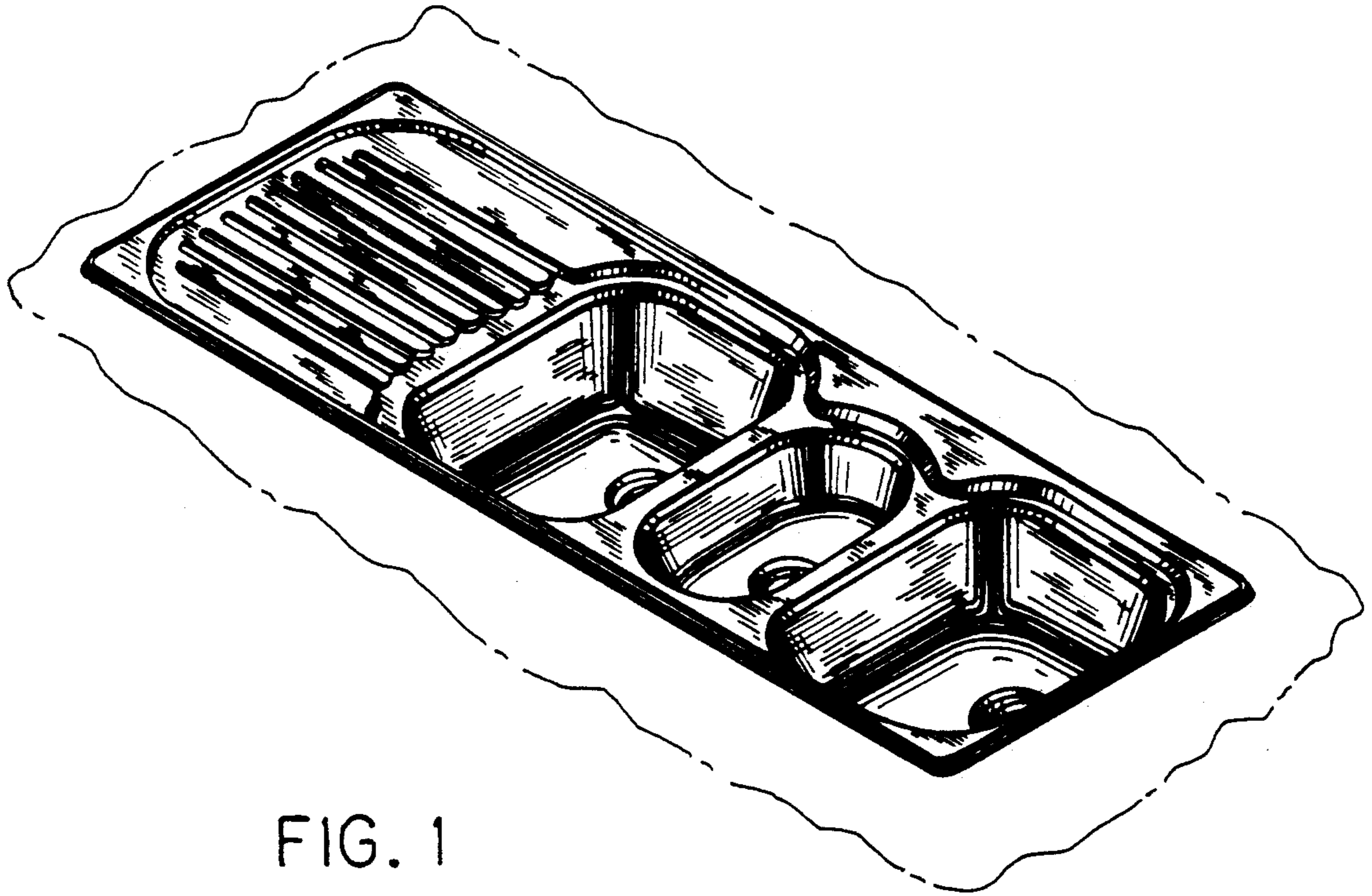
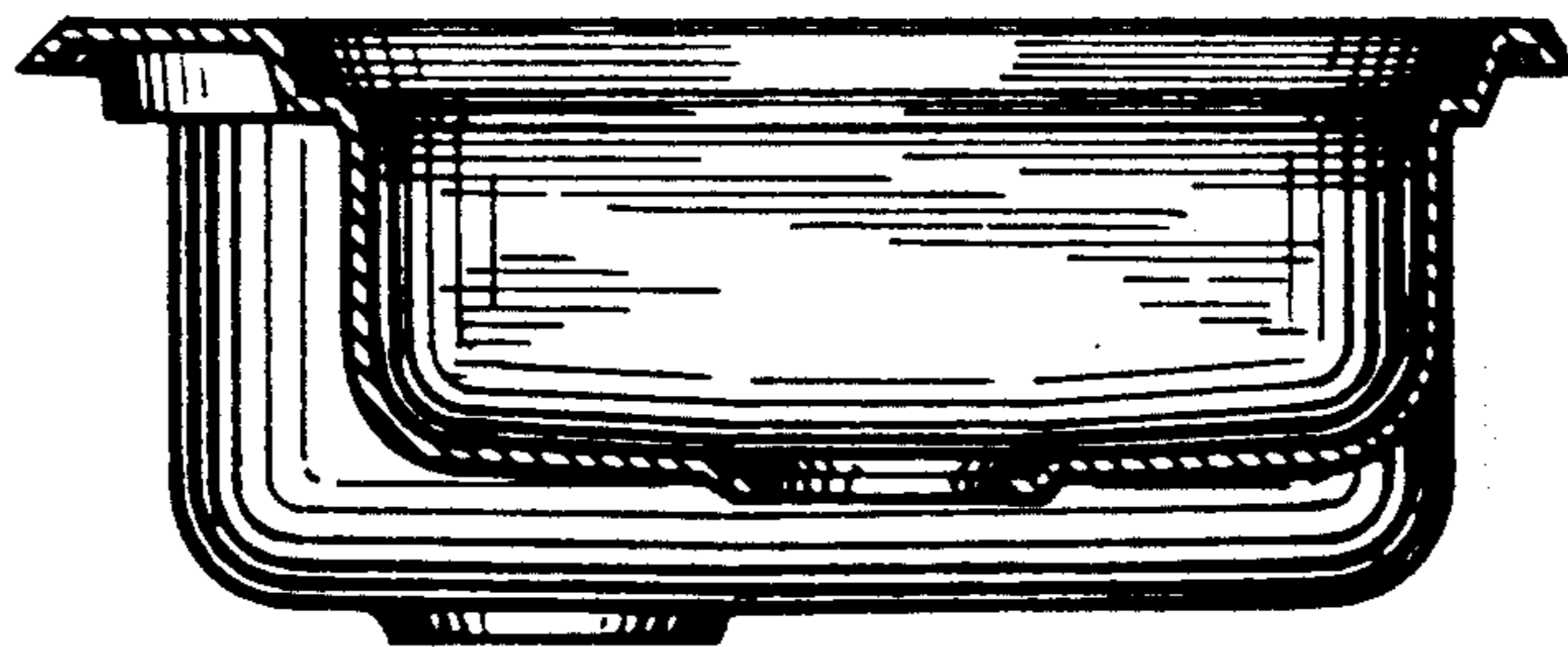

FIG. 1

FIG. 5



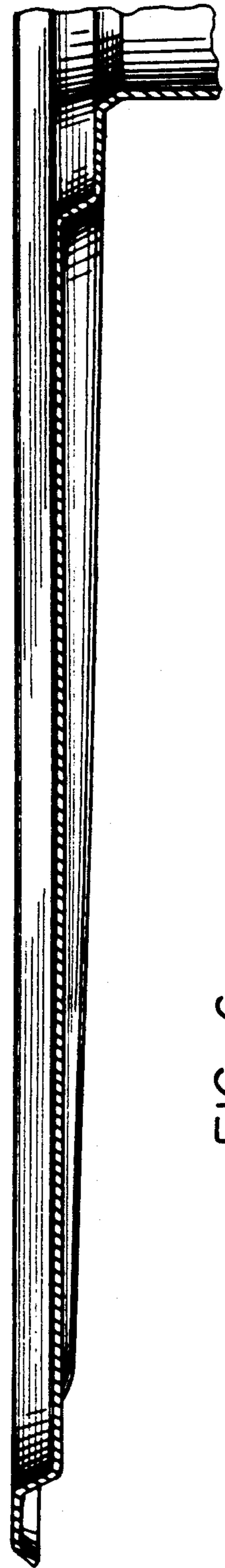
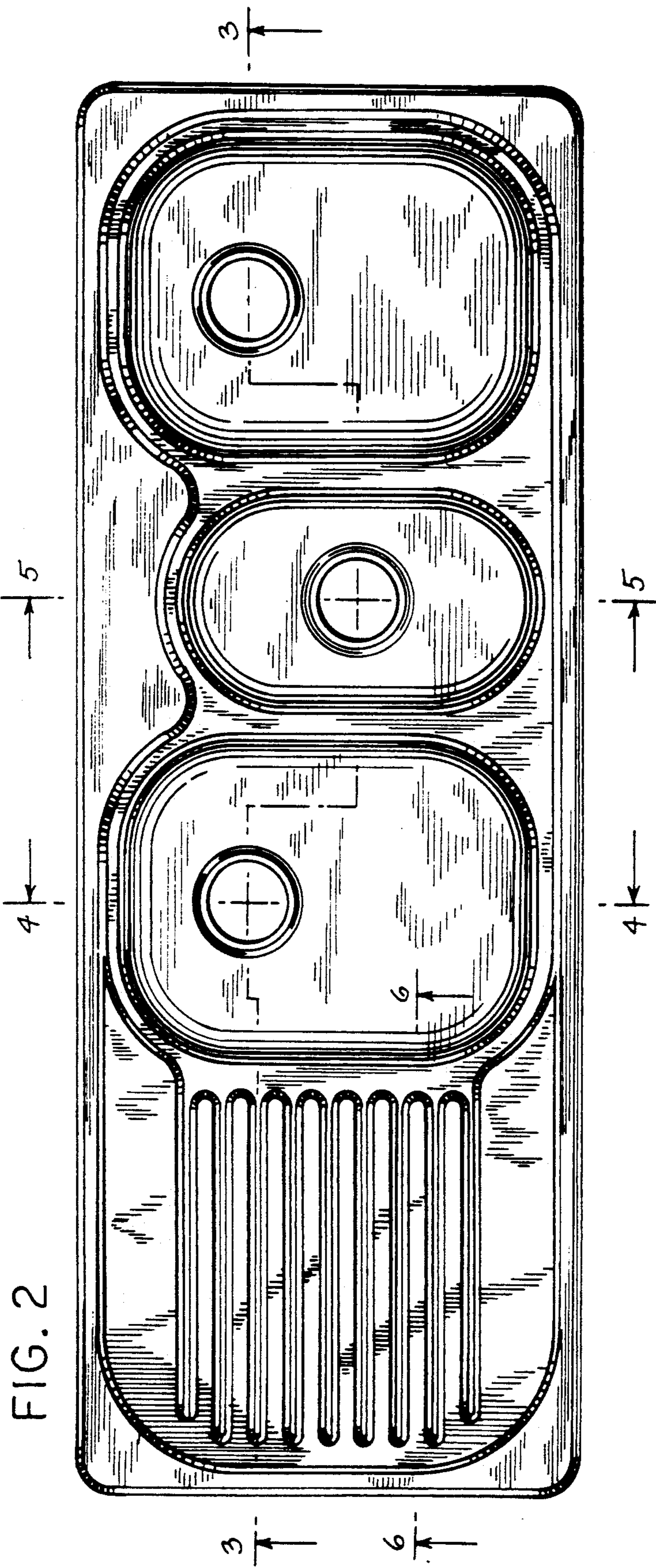

FIG. 6

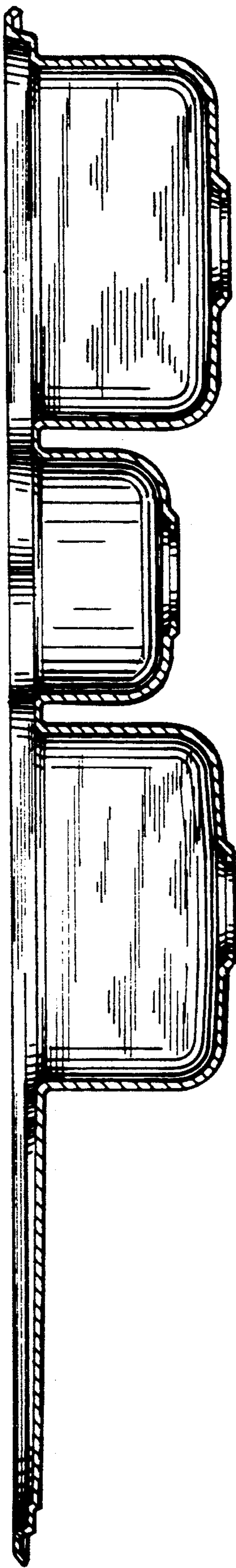

FIG. 3



FIG. 4

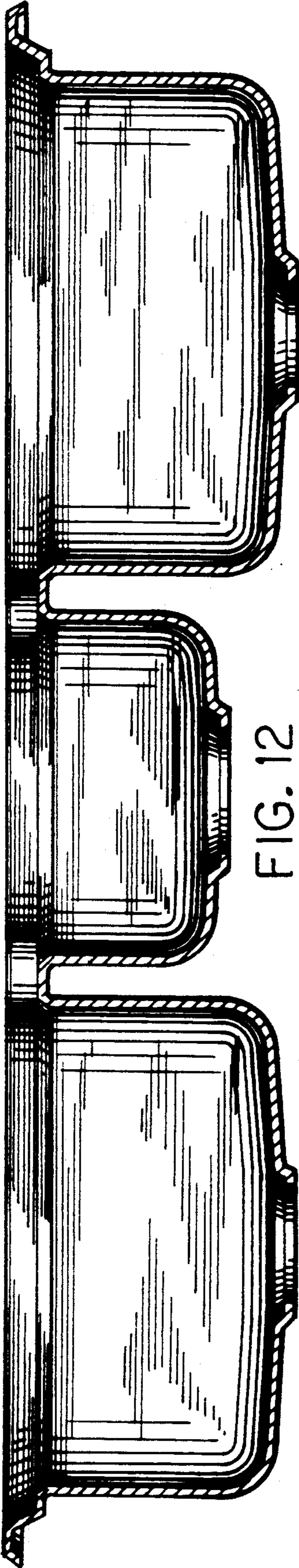
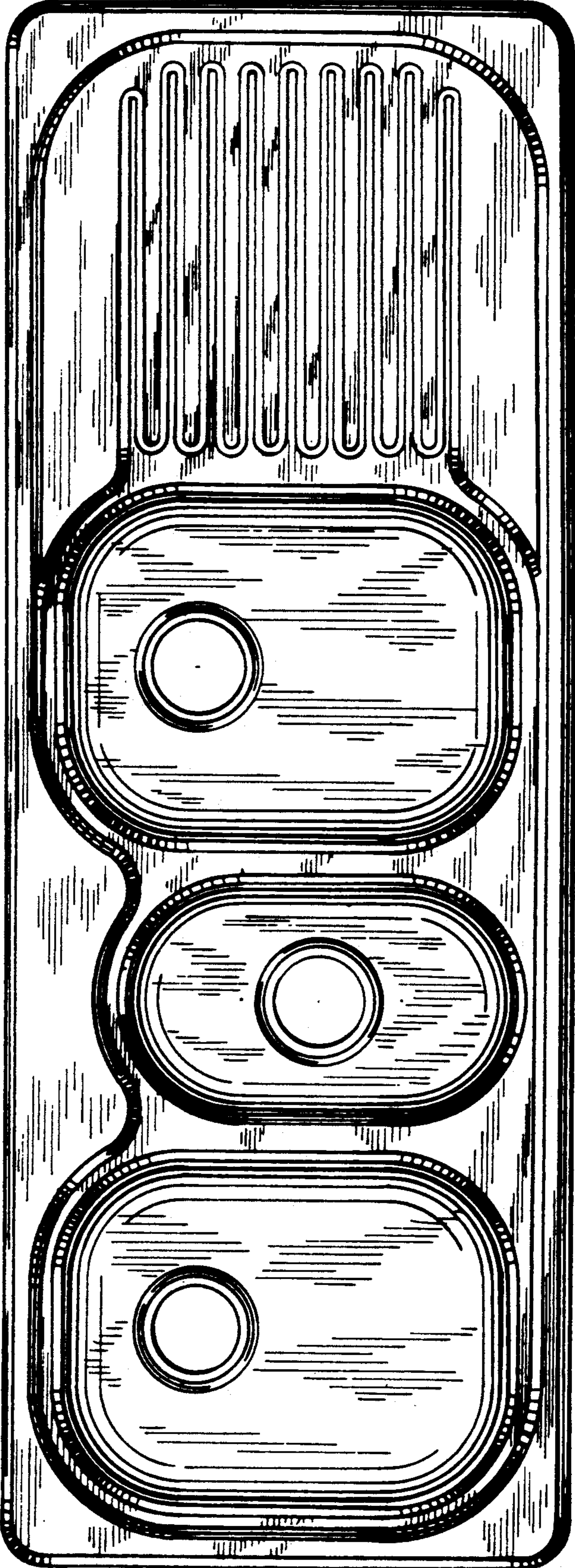

FIG. 12

FIG. 7



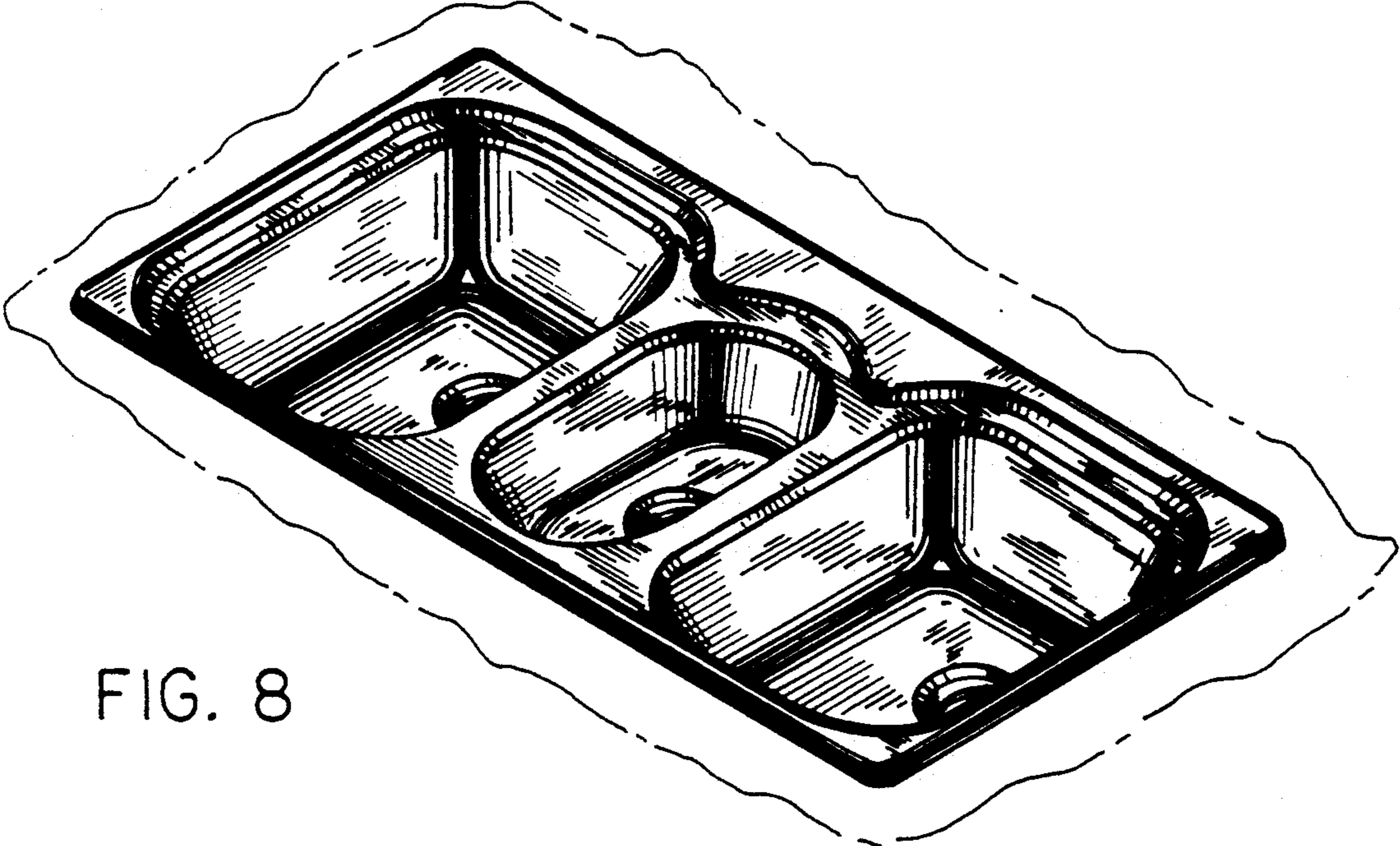

FIG. 8



FIG. 10



FIG. 11

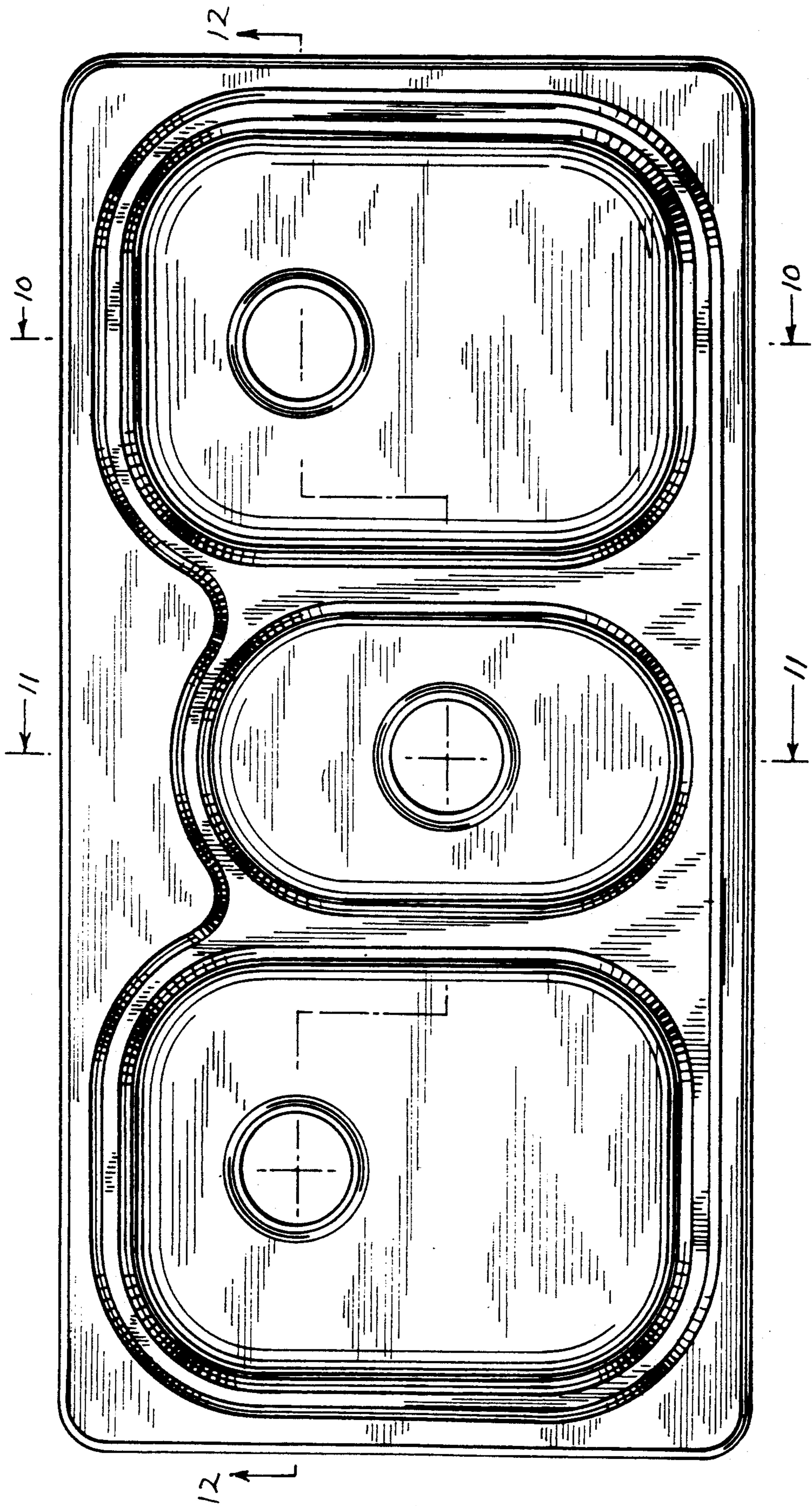

FIG. 9