



US00D331862S

# United States Patent [19]

[11] Patent Number: **Des. 331,862**

**Brown**

[45] Date of Patent: **\*\* Dec. 22, 1992**

[54] **SWIVEL CUP HOLDER**

D. 326,984 6/1992 Lahr ..... D7/620

[76] Inventor: **David R. Brown**, 387 E. Catawba Ave., Mooresville, N.C. 28115

*Primary Examiner*—Terry A. Pfeffer  
*Attorney, Agent, or Firm*—Leon Gilden

[\*\*] Term: **14 Years**

[57] **CLAIM**

[21] Appl. No.: **652,273**

The ornamental design for a swivel cup holder, as shown and described.

[22] Filed: **Feb. 7, 1991**

[52] U.S. Cl. .... **D7/620**

[58] Field of Search ..... **D7/616-625;**  
108/44-46; 211/71, 74; 220/737, 738; 248/310,  
311.2, 313

**DESCRIPTION**

[56] **References Cited**

**U.S. PATENT DOCUMENTS**

D. 306,929 3/1990 Flowers ..... **D7/620 X**

FIG. 1 is a front elevational view of the swivel cup holder showing my new design;  
FIG. 2 is a rear elevational view thereof;  
FIG. 3 is a left side elevational view thereof;  
FIG. 4 is a right side elevational view thereof;  
FIG. 5 is a top plan view thereof;  
FIG. 6 is a bottom plan view thereof; and,  
FIG. 7 is a perspective view thereof.

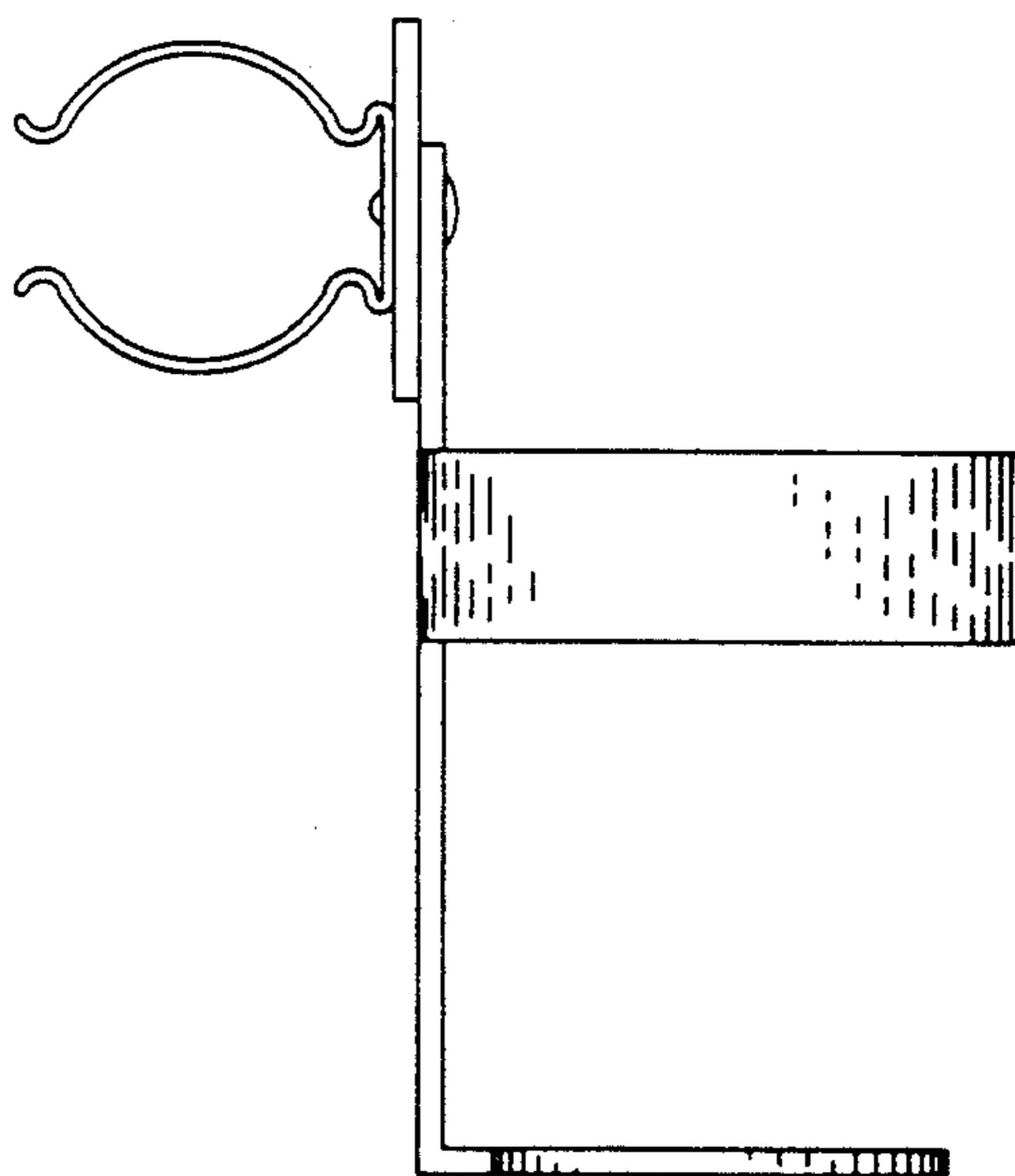
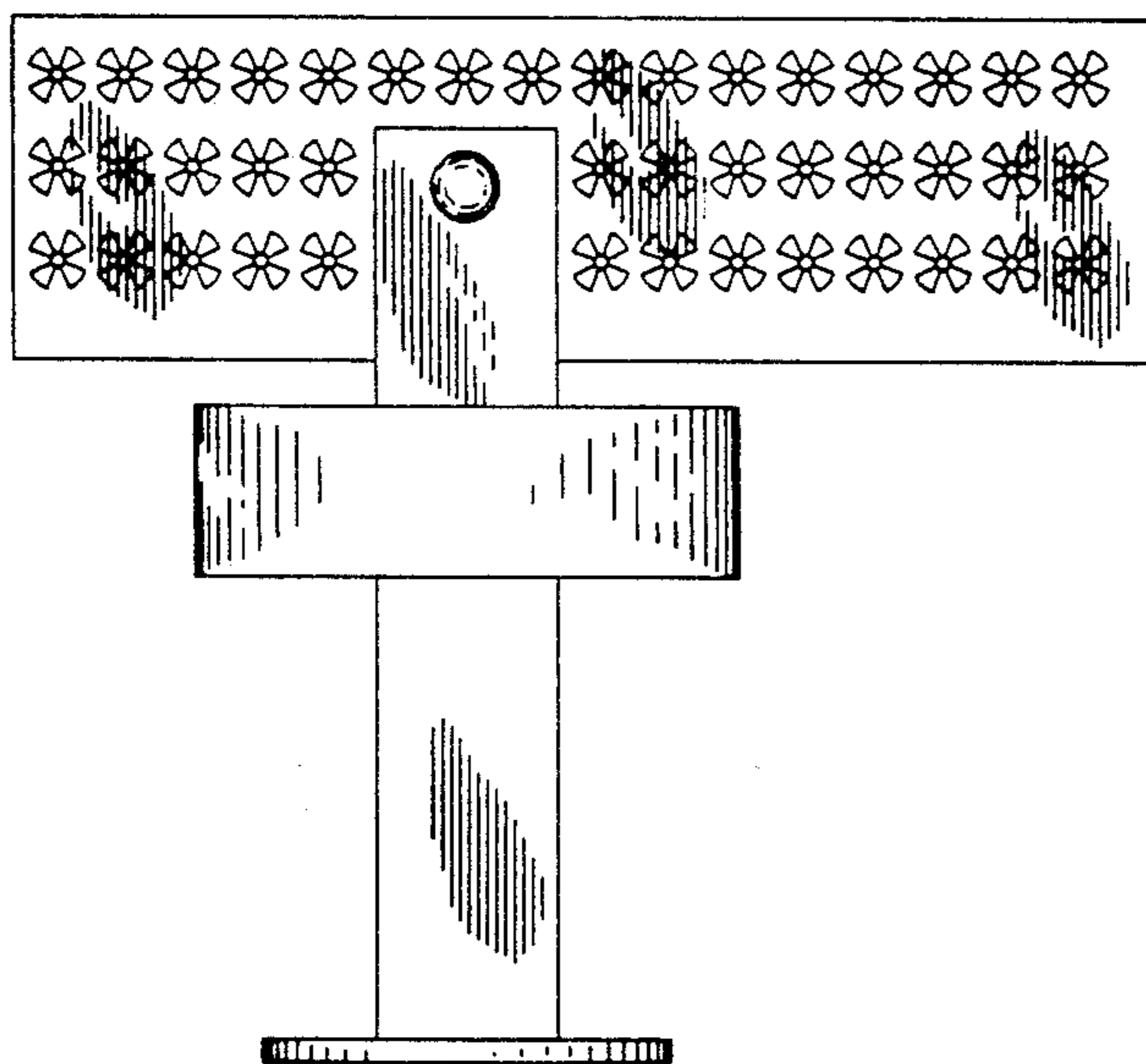

FIG. 1

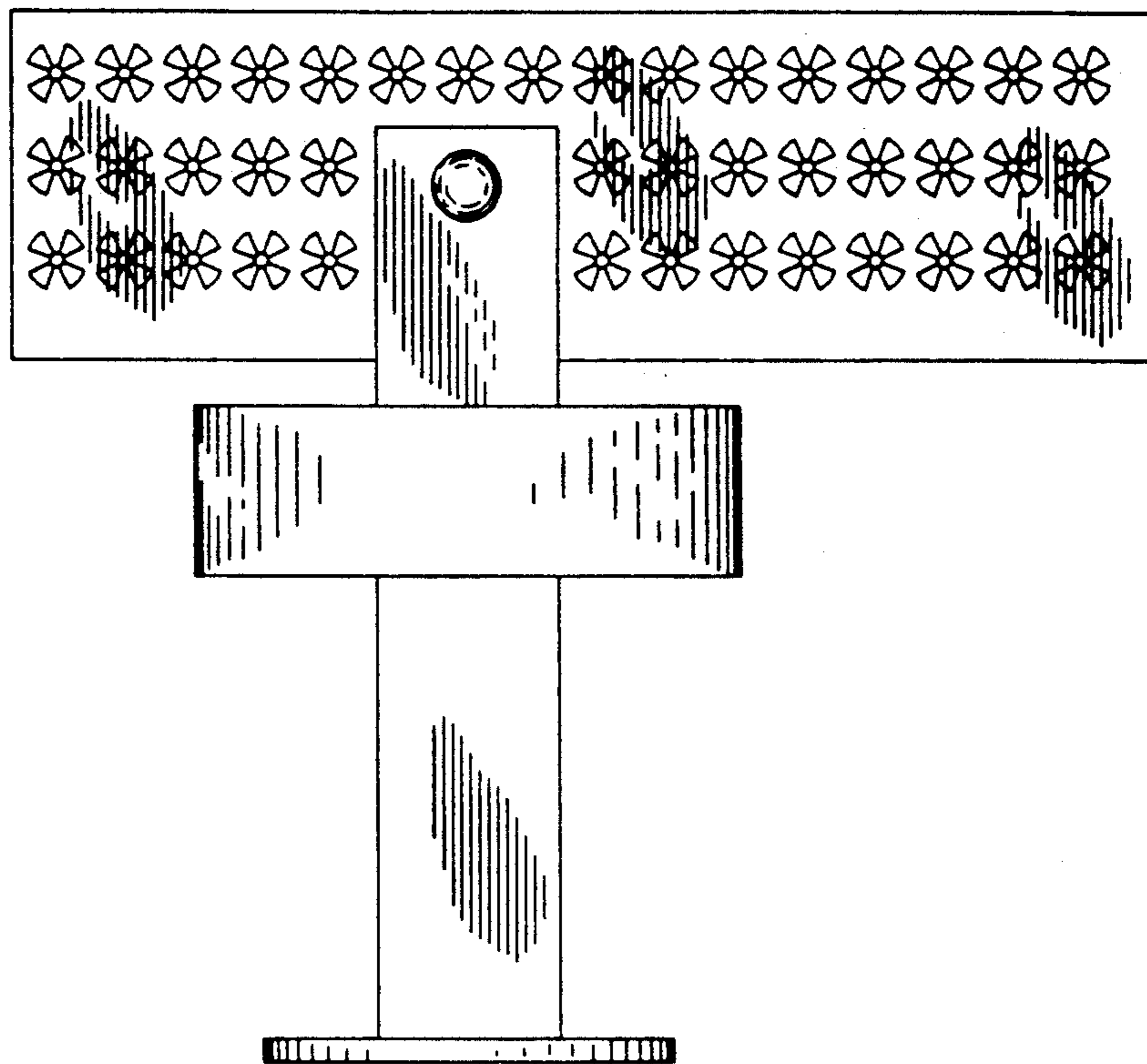

FIG. 2

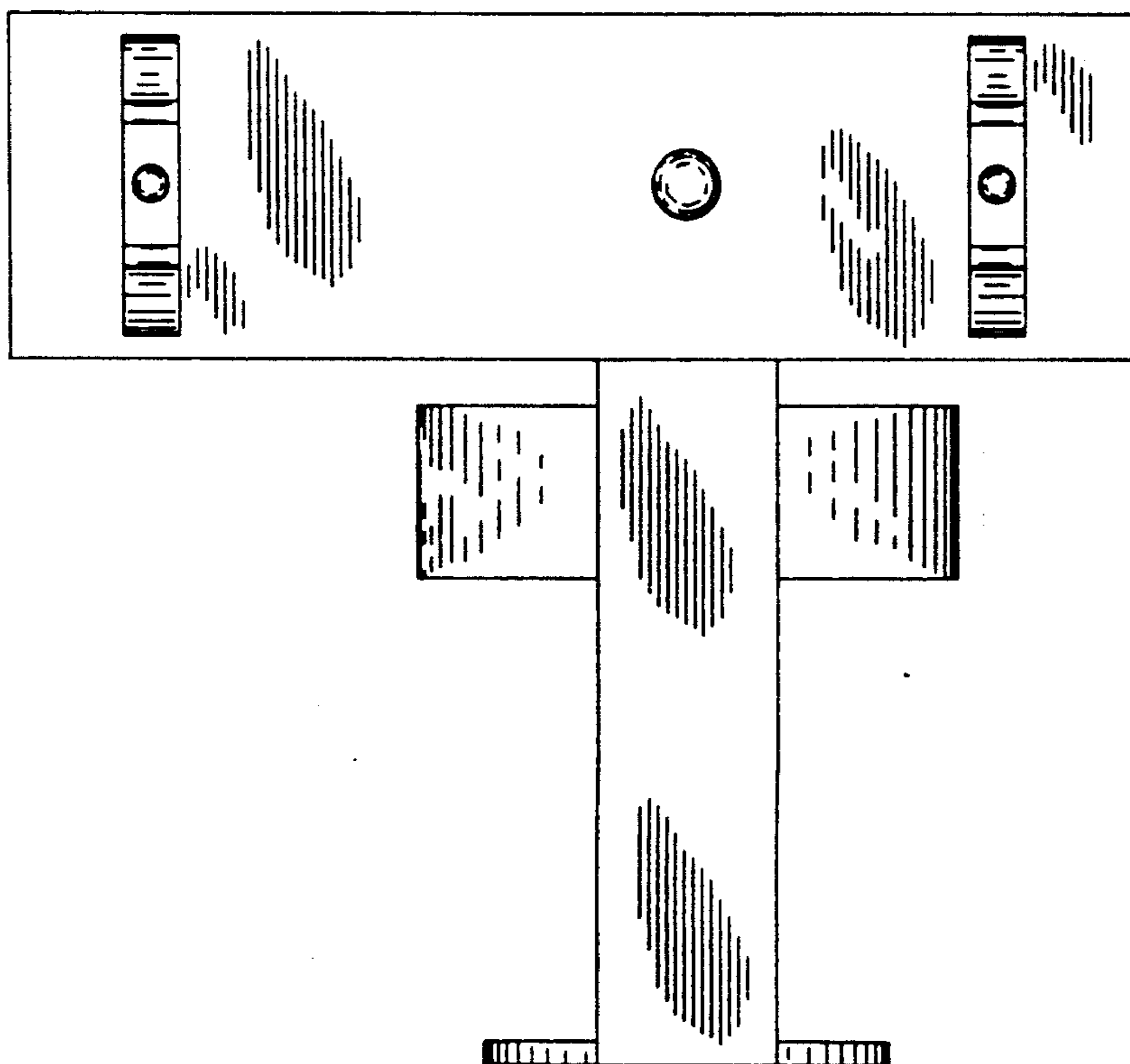

FIG. 3

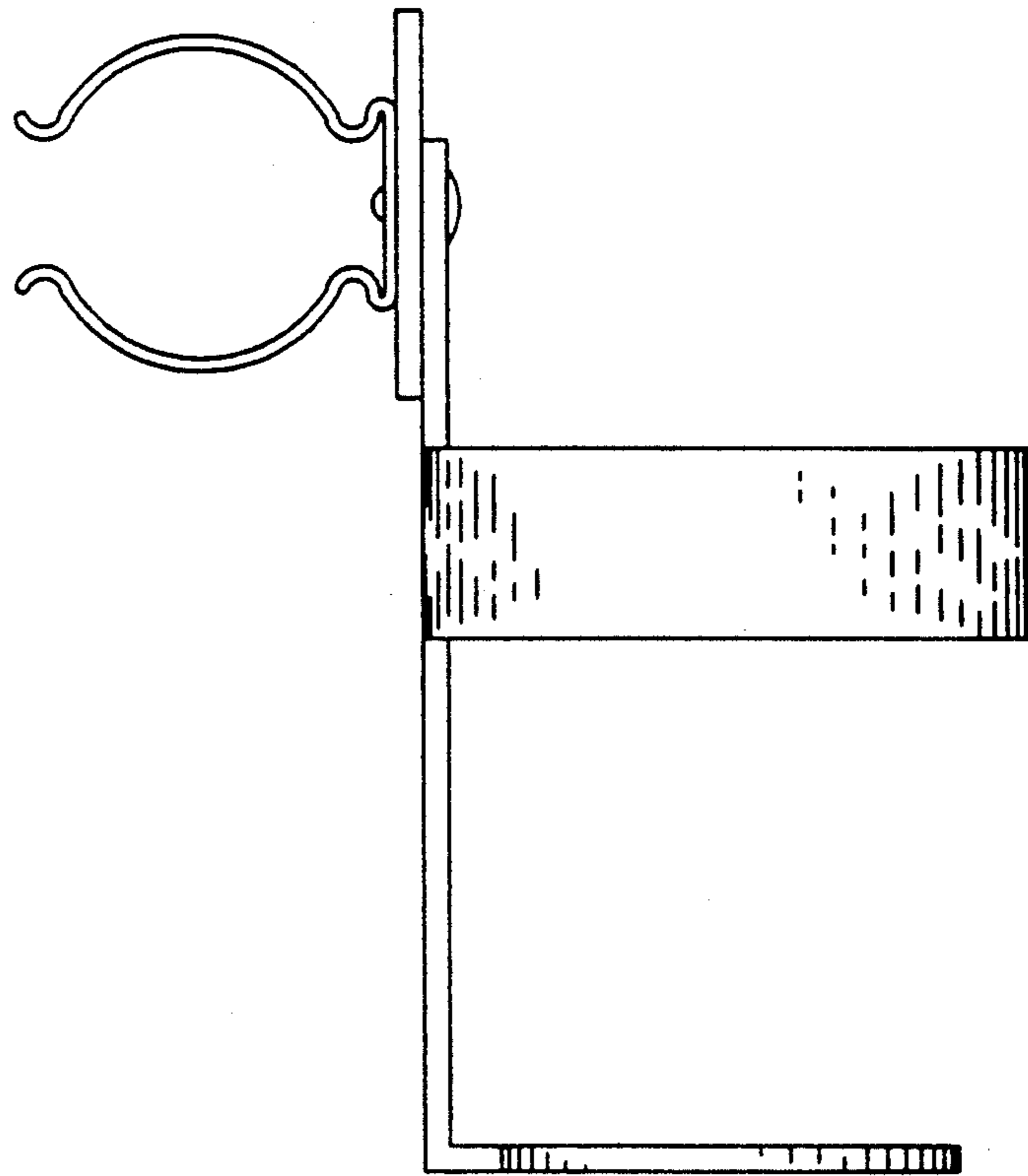

FIG. 4

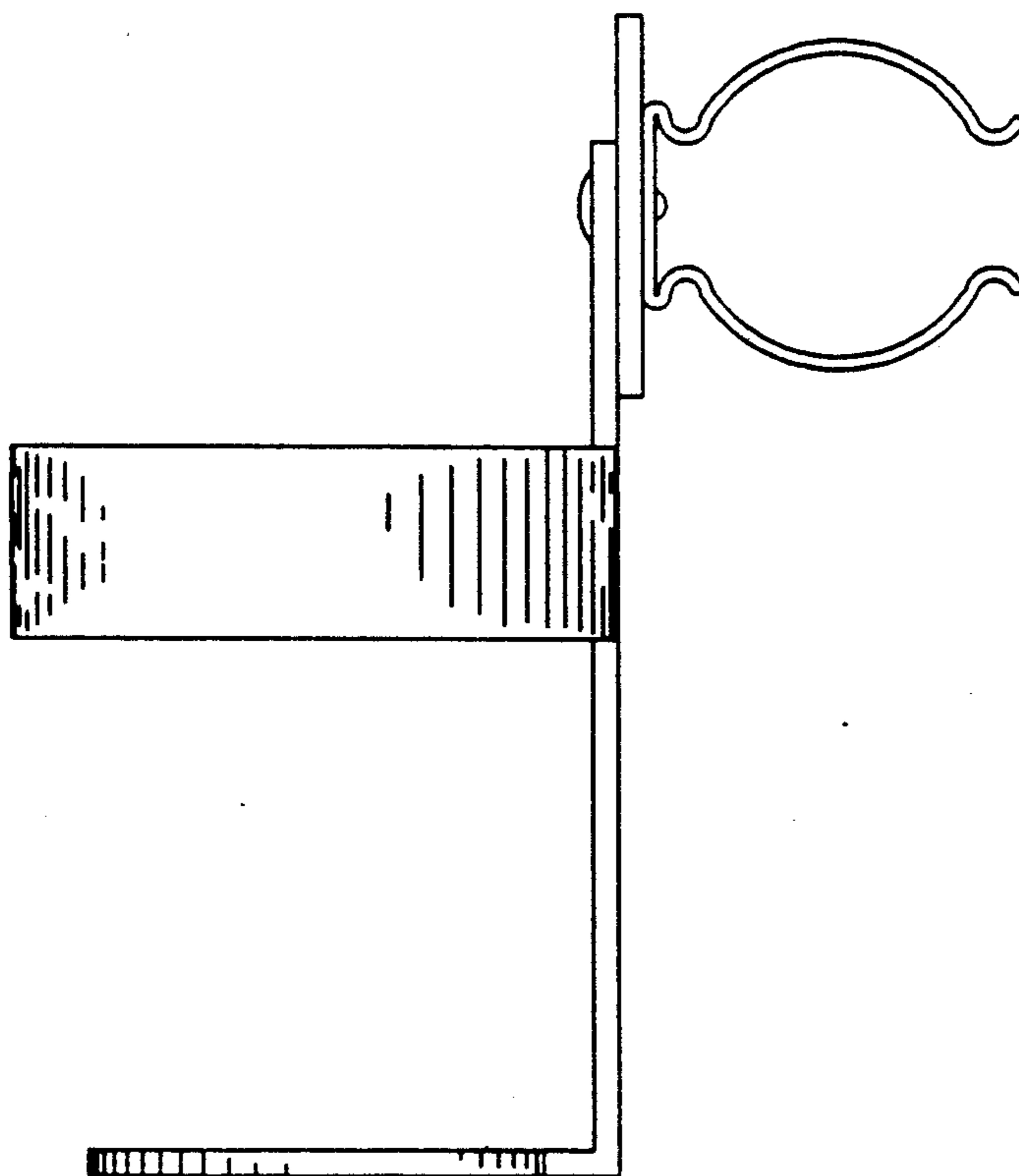

FIG. 5

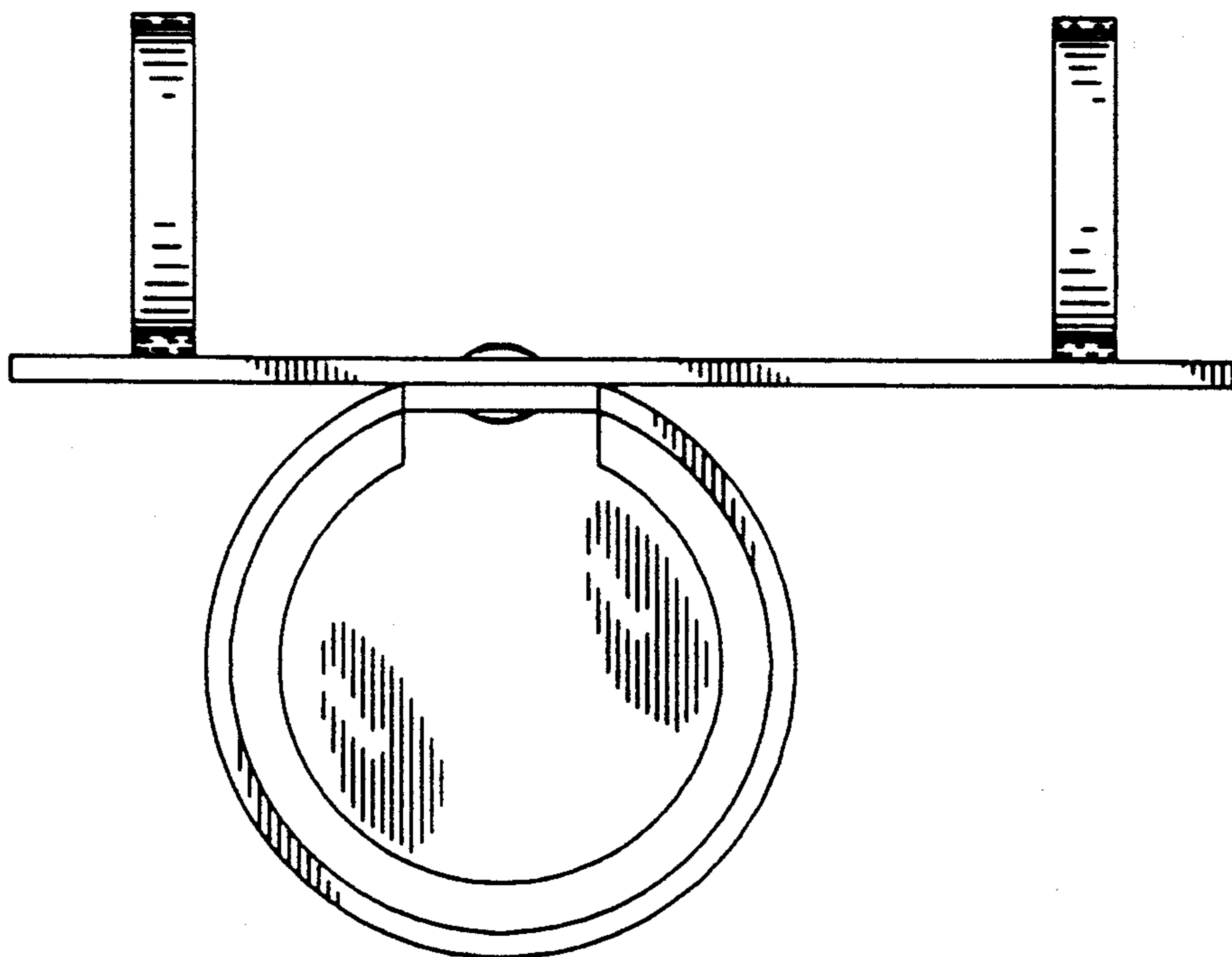

FIG. 6

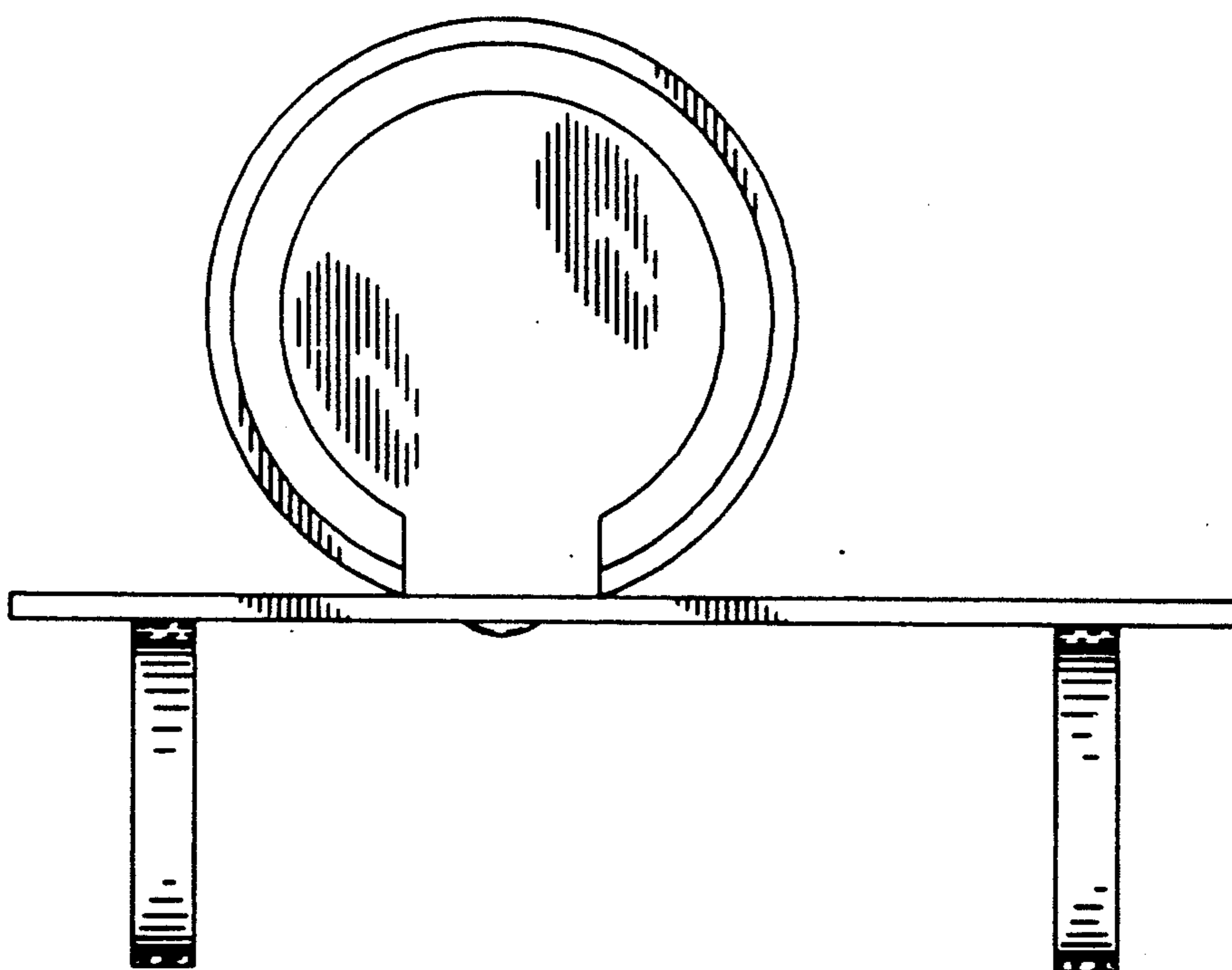

FIG. 7

