



US00D331840S

# United States Patent [19]

[11] Patent Number: **Des. 331,840**

**Garner**

[45] Date of Patent: **\*\* Dec. 22, 1992**

[54] **PET BRUSH FOR ATTACHMENT TO A WATER HOSE**

[76] Inventor: **Steven J. Garner, 36 Hudson St., Springfield, Mass. 01118**

[\*\*] Term: **14 Years**

[21] Appl. No.: **659,051**

[22] Filed: **Feb. 29, 1991**

[52] U.S. Cl. .... **D4/114; D4/136; D30/158**

[58] Field of Search ..... **D30/158-160, D30/162; 119/83, 86-87, 89, 92-93; D4/127, 130, 132, 134, 136, 138, 100, 102, 117, 114, 115, 124, 125; 15/184, 160, 143 R, 159 R, 159 A, 105-106; D8/13; D9/310, 313; 132/126, 139, 116, 150, 159, 161, 219, 271, 901; 43/137; D22/124; D28/21-22, 24-25, 28-31, 13, 15, 18**

[56] **References Cited**

**U.S. PATENT DOCUMENTS**

- D. 182,016 2/1958 Dean ..... D4/136
- D. 205,821 9/1966 Lattimer ..... 132/161 X
- D. 209,724 12/1967 McNair ..... D28/24
- D. 234,304 2/1975 Schmieler ..... D30/162
- D. 244,712 6/1977 Houston ..... D30/159
- D. 279,648 7/1985 Fini ..... D4/114
- D. 307,067 4/1990 Kuhl et al. .... 119/83

- D. 317,083 5/1991 Chou ..... D4/115
- D. 318,180 7/1991 Kai-Wing ..... D4/114
- D. 319,923 9/1991 Chou ..... D4/121
- 2,410,086 10/1946 Lewis ..... 132/161
- 3,053,264 9/1962 Breton ..... 132/116
- 4,934,855 6/1990 Recchelbacher ..... D4/114

**OTHER PUBLICATIONS**

Pedigrees The Pet Catalog; p. 33 item needlepoint pattern.

*Primary Examiner*—A. Hugo Word  
*Assistant Examiner*—Cathy Anne MacCormac  
*Attorney, Agent, or Firm*—Leon Gilden

[57] **CLAIM**

The ornamental design for a pet brush for attachment to a water hose, as shown and described.

**DESCRIPTION**

FIG. 1 is a front elevational view of a pet brush for attachment to a water hose showing my new design; FIG. 2 is a rear elevational view thereof; FIG. 3 is a left side elevational view thereof; FIG. 4 is a right side elevational view thereof; FIG. 5 is a top plan view thereof; FIG. 6 is a bottom plan view thereof; FIG. 7 is a top perspective view thereof; and, FIG. 8 is a bottom perspective view thereof.

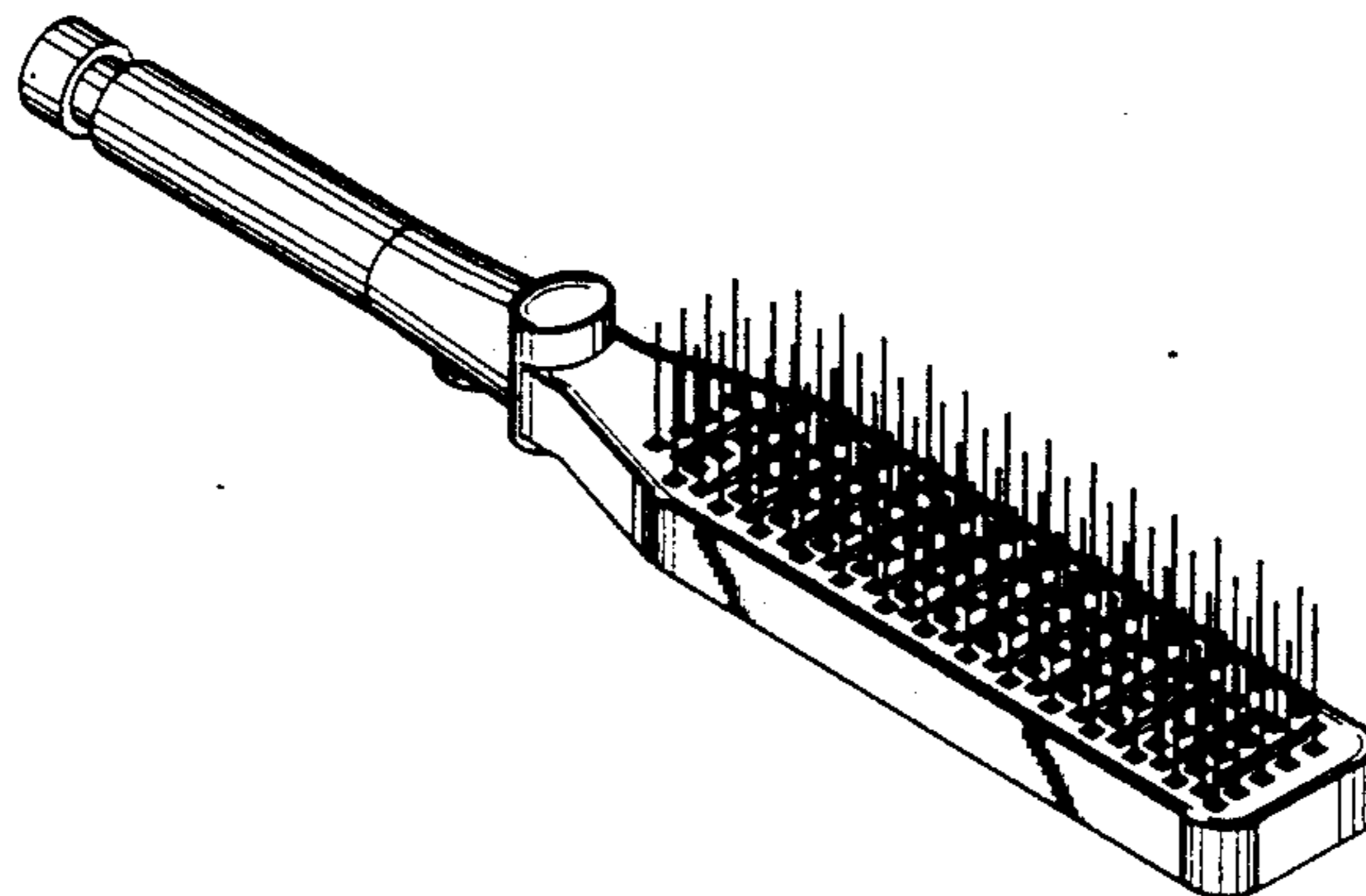
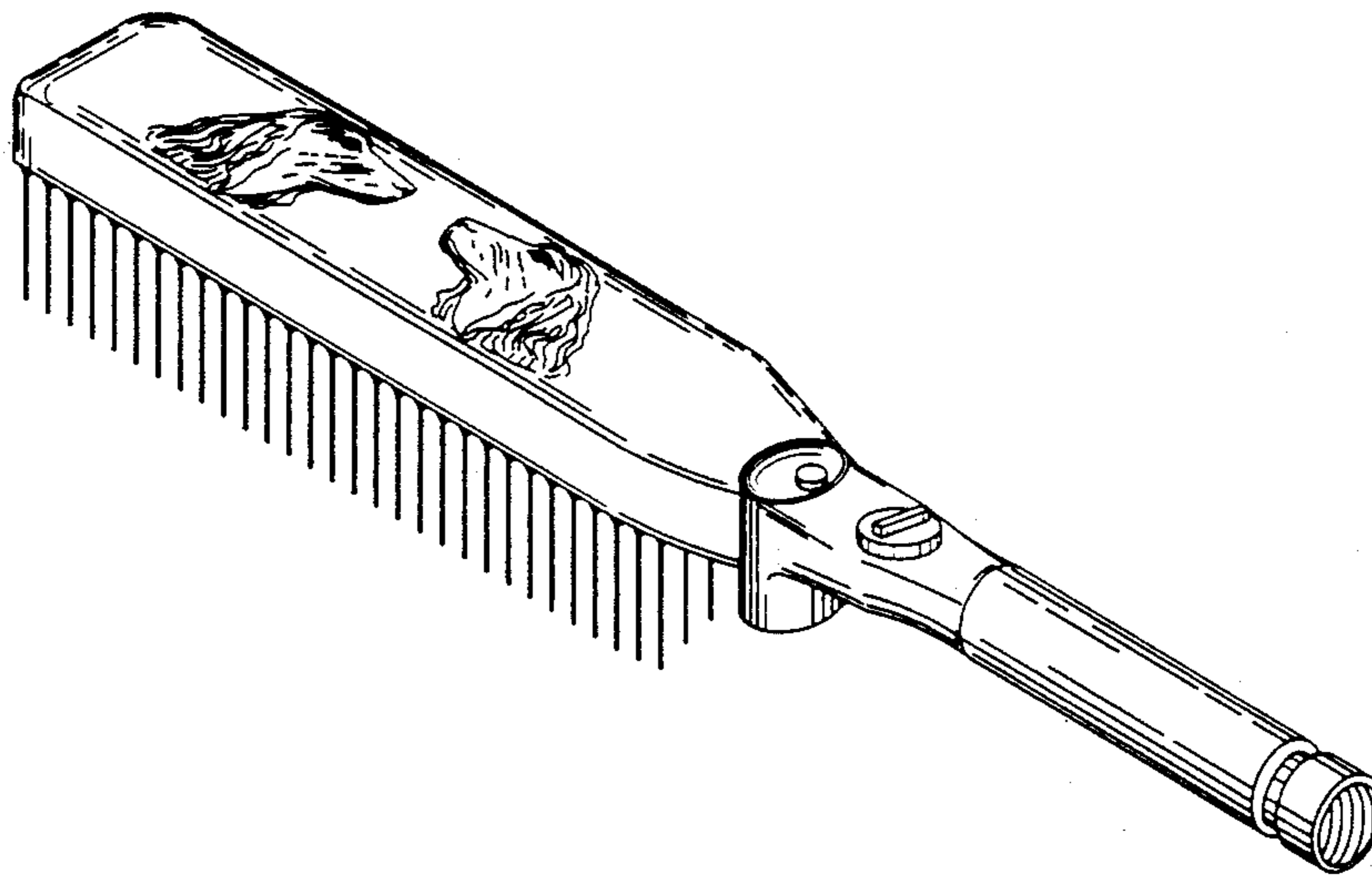

FIG. 1

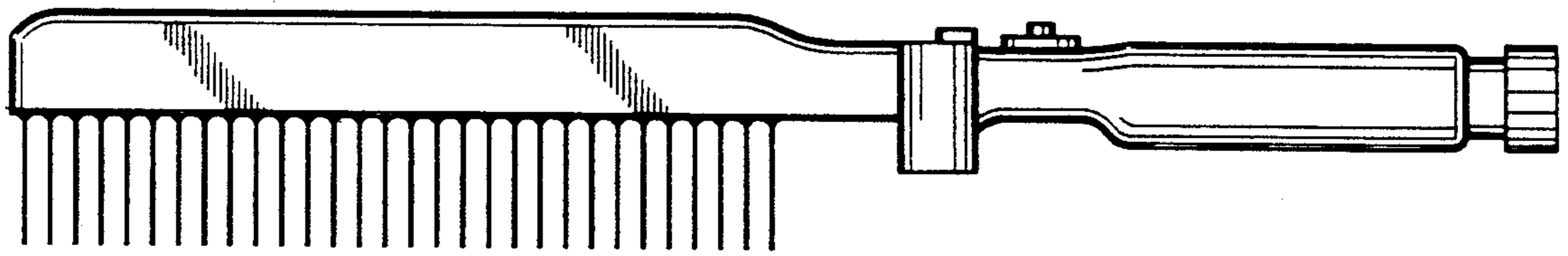
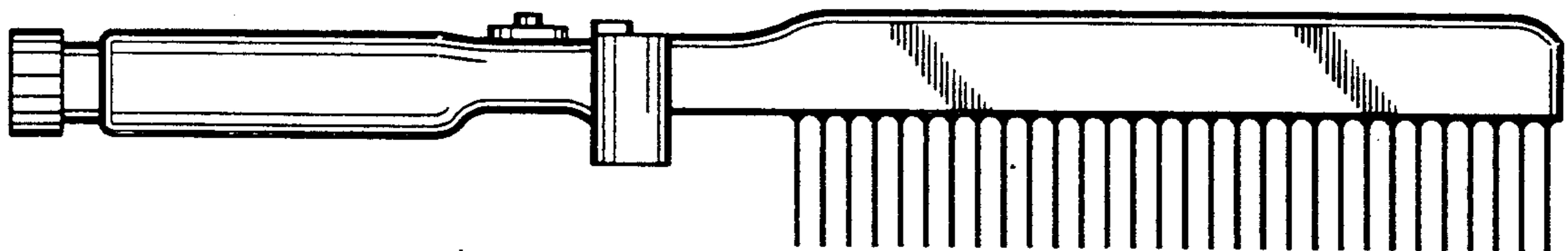
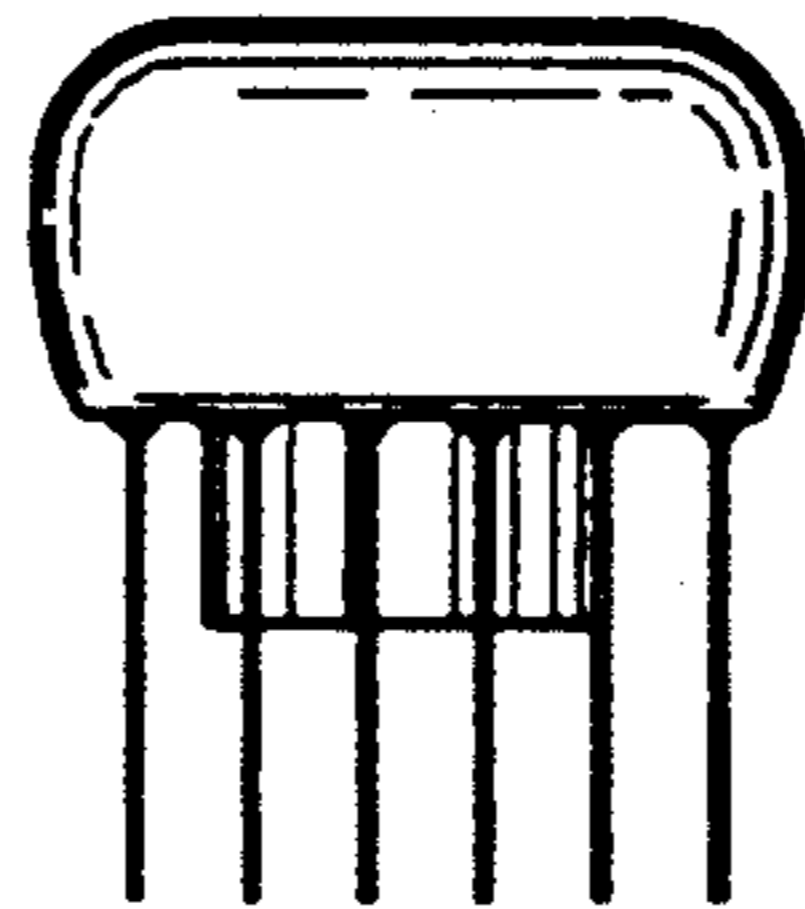

FIG. 2



*FIG. 3*



*FIG. 4*

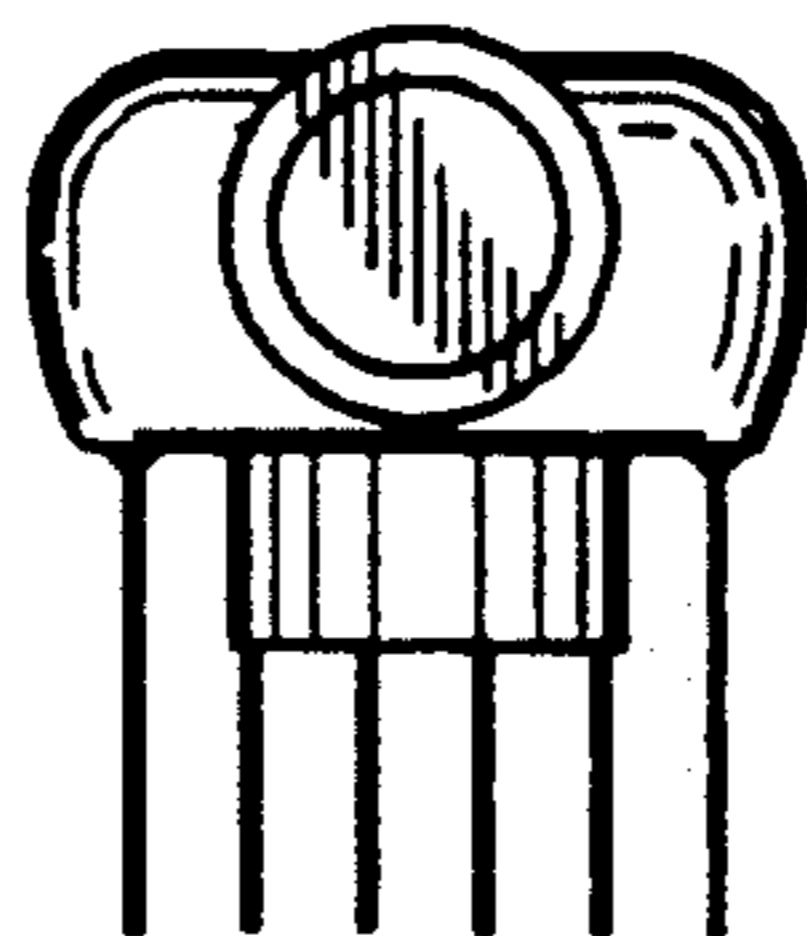

FIG. 5

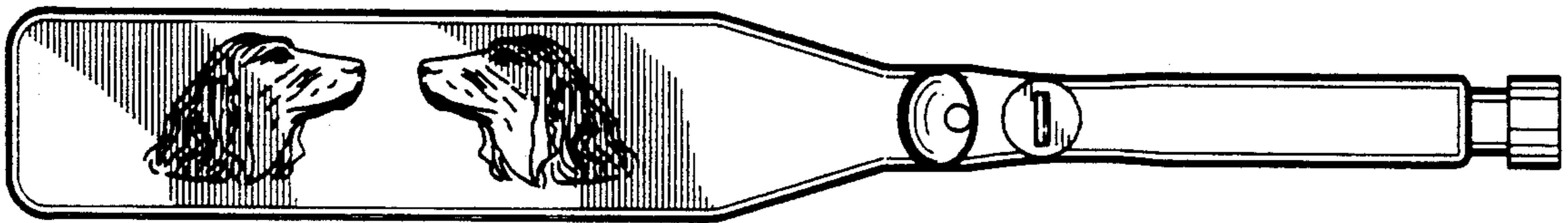

FIG. 6

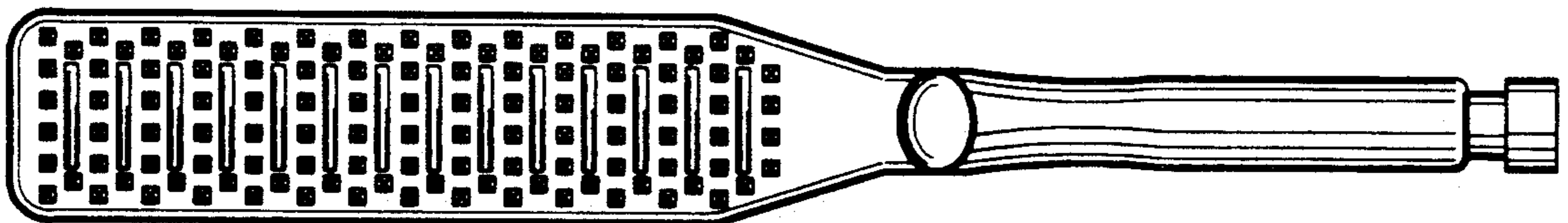

FIG. 7

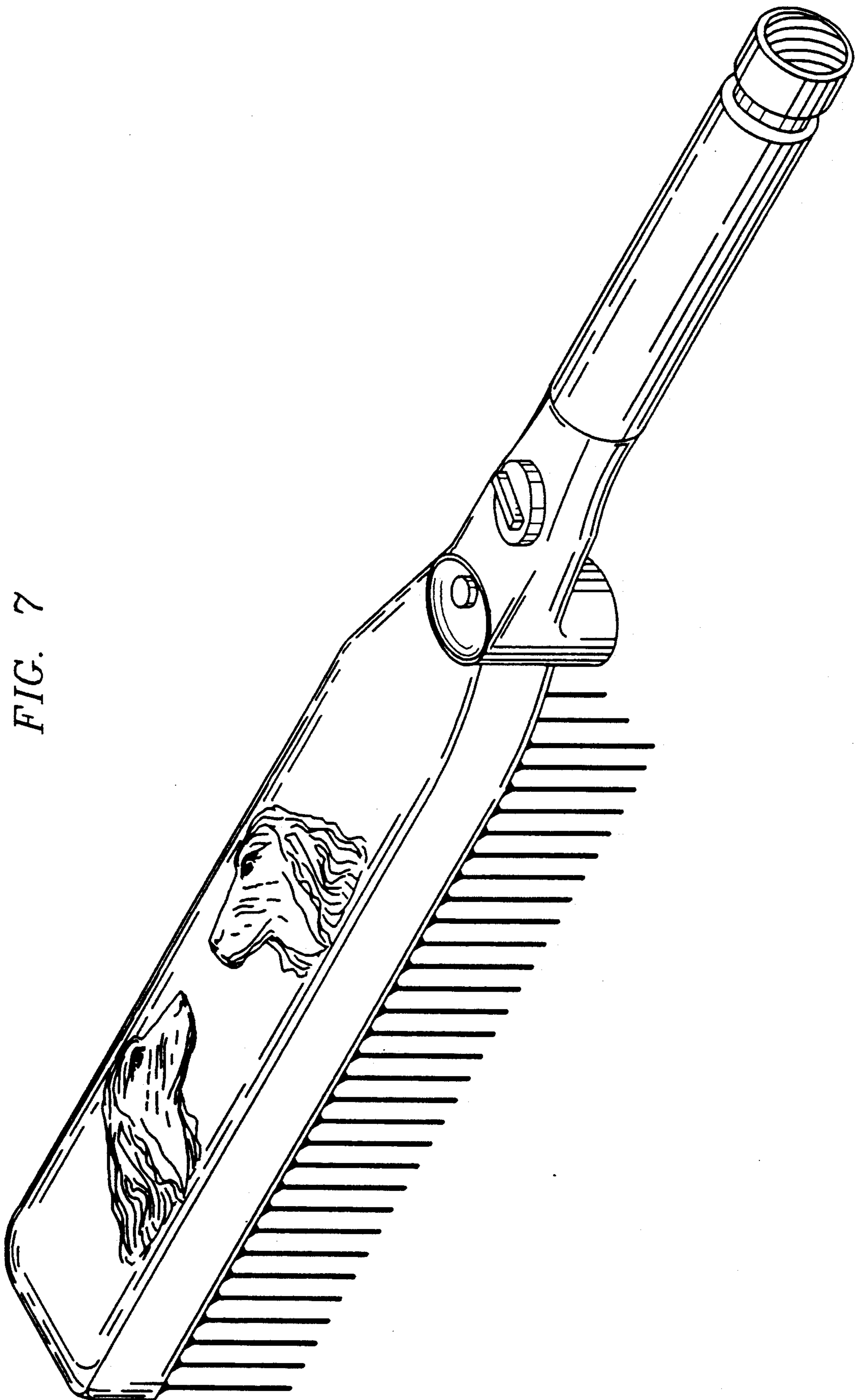

FIG. 8

