



US00D331785S

# United States Patent [19]

[11] Patent Number: **Des. 331,785**

**Mast**

[45] Date of Patent: **\*\* Dec. 15, 1992**

- [54] PINWHEEL
- [75] Inventor: **Richard Mast, Brooklyn, N.Y.**
- [73] Assignee: **Norjac Mfg., Brooklyn, N.Y.**
- [\*\*] Term: **14 Years**
- [21] Appl. No.: **573,669**
- [22] Filed: **Aug. 27, 1990**
- [52] U.S. Cl. .... **D21/93**
- [58] Field of Search ..... **D21/93; 446/217, 218, 446/236, 487, 488; D23/370, 386**

*Attorney, Agent, or Firm—Herbert Dubno; Ronald Lianides*

### [57] CLAIM

The ornamental design for a pinwheel, as shown and described.

### DESCRIPTION

FIG. 1 is a front elevational view of a pinwheel showing my new design;  
 FIG. 2 is a right side elevational view thereof, the top being identical and the left side and bottom being a mirror image;  
 FIG. 3 is a rear elevational view thereof;  
 FIG. 4 is a front elevational view of a second embodiment of FIG. 1;  
 FIG. 5 is a right side elevational view of FIG. 4, the top being identical and the left side and bottom being a mirror image; and,  
 FIG. 6 is a rear elevational view of FIG. 4.  
 The broken line showing of the support in FIGS. 2 and 5, is for illustrative purposes only and forms no part of the claim.

[56] **References Cited**  
**U.S. PATENT DOCUMENTS**

D. 60,094	12/1921	Heindl	.....	D21/93
D. 71,946	2/1927	Short	.....	D21/93
D. 197,901	4/1964	Lee	.....	D21/93
1,769,784	4/1930	Hoppe	.....	446/217
2,510,336	6/1950	Donahue	.....	446/217
3,475,850	11/1969	Lee	.....	446/217

*Primary Examiner—Bernard Ansher*  
*Assistant Examiner—Dominic Simone*

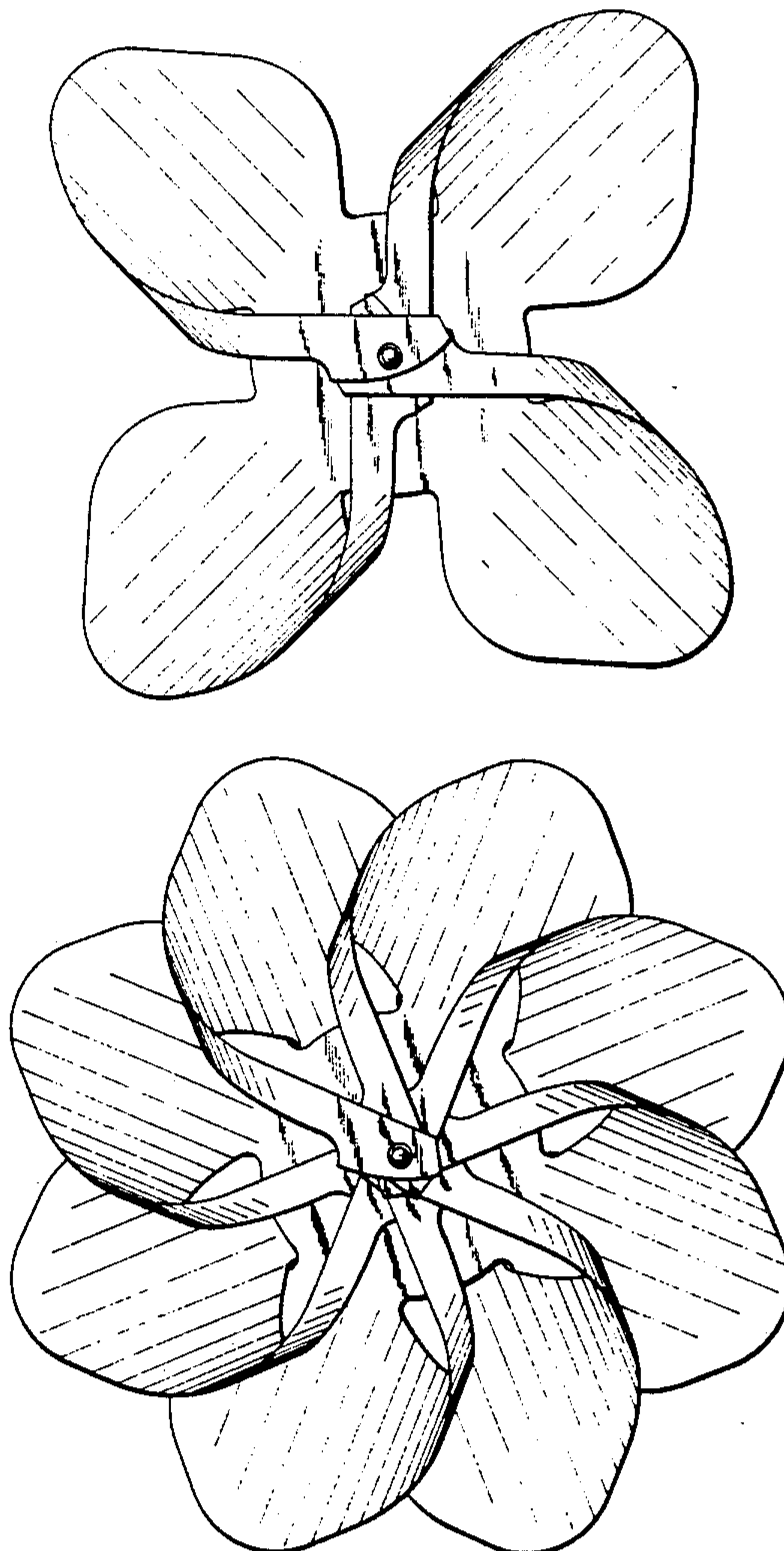

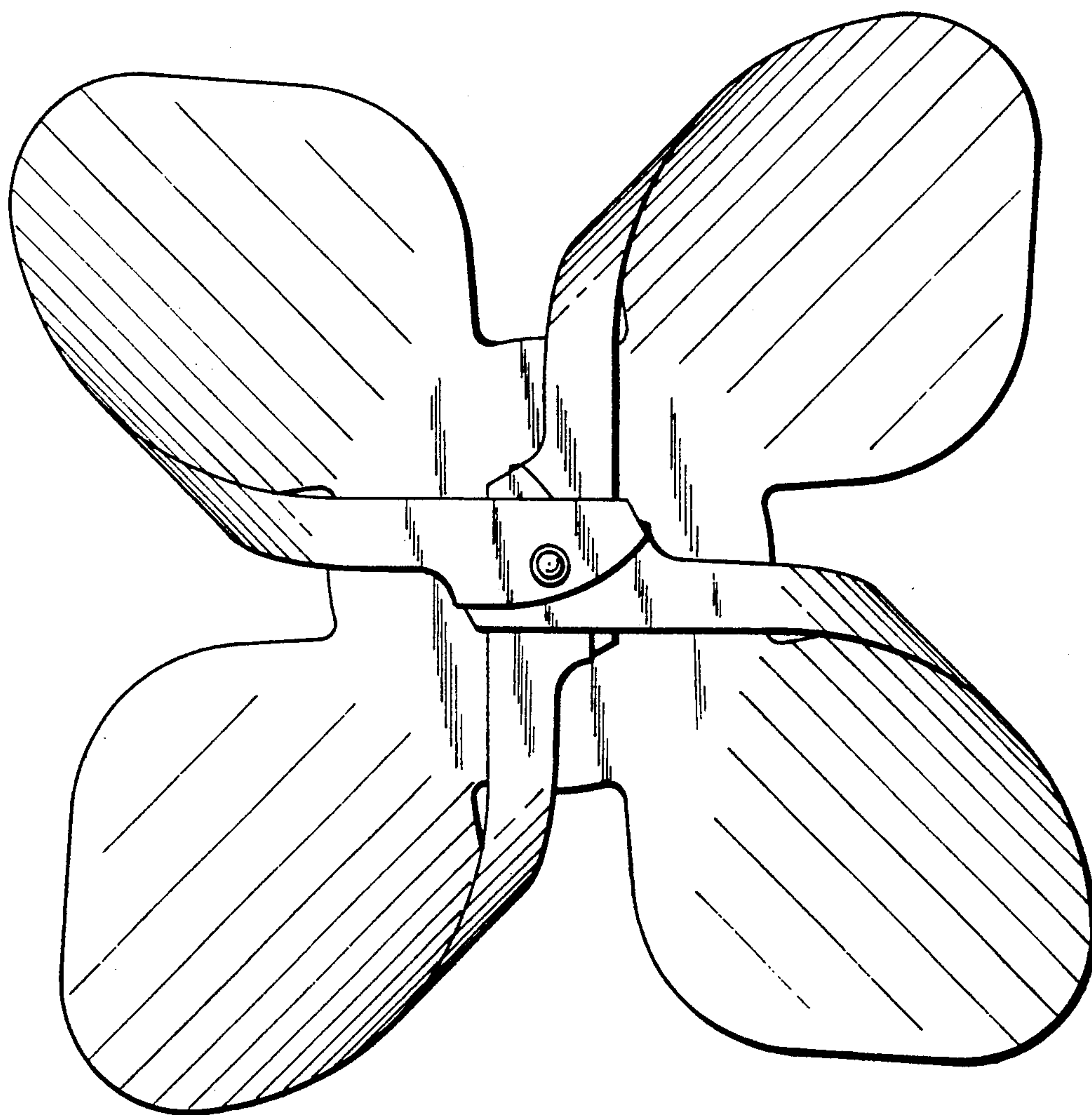

FIG. 1

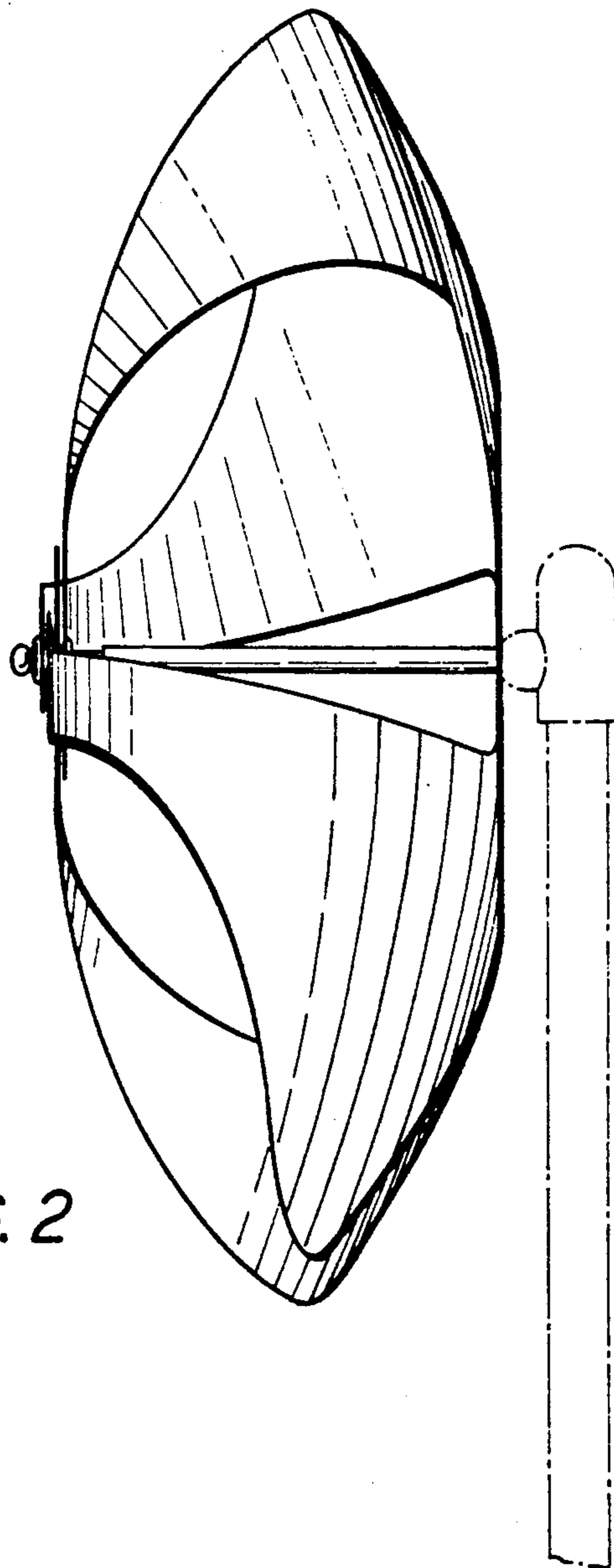

FIG. 2

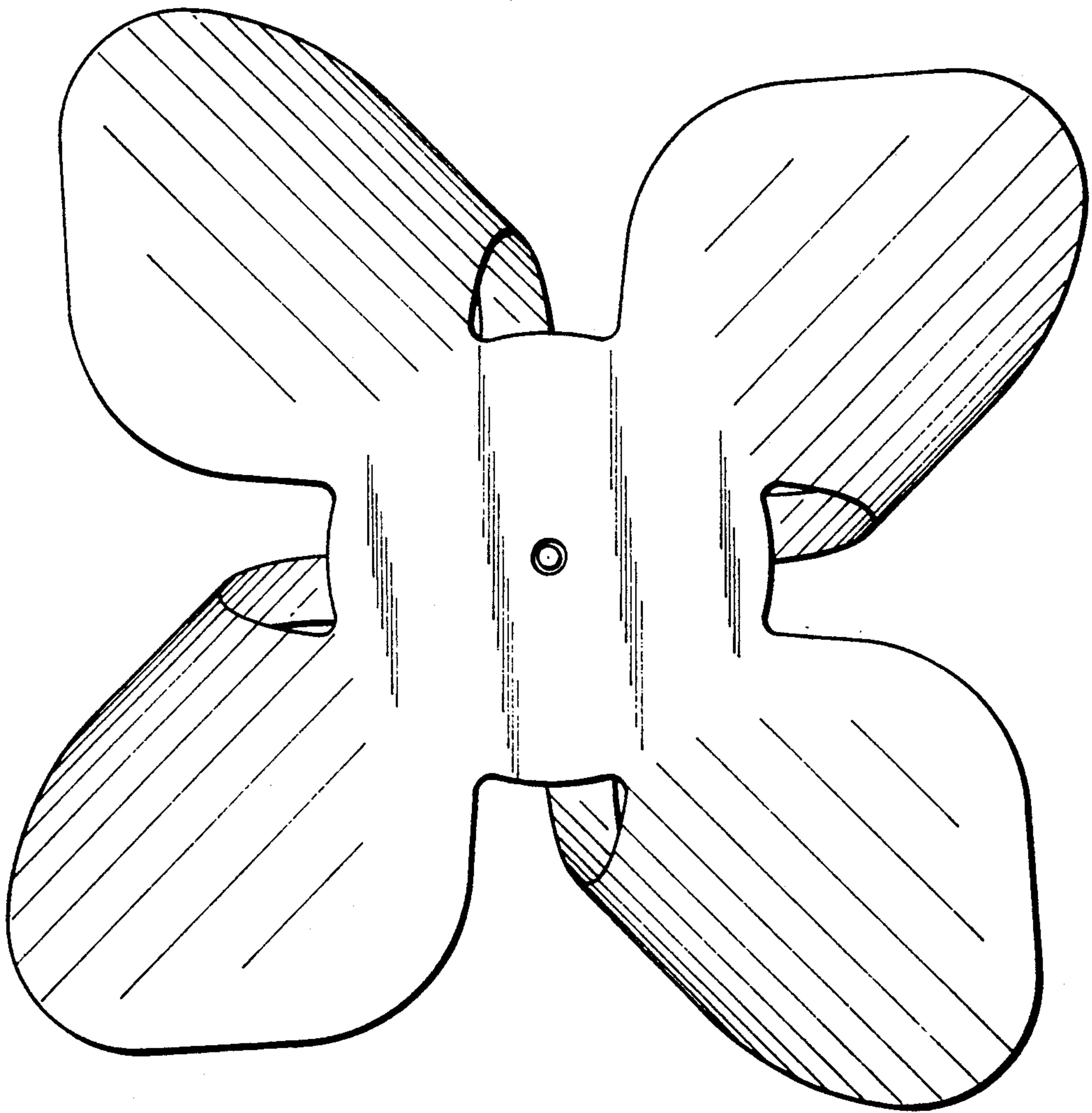

FIG. 3



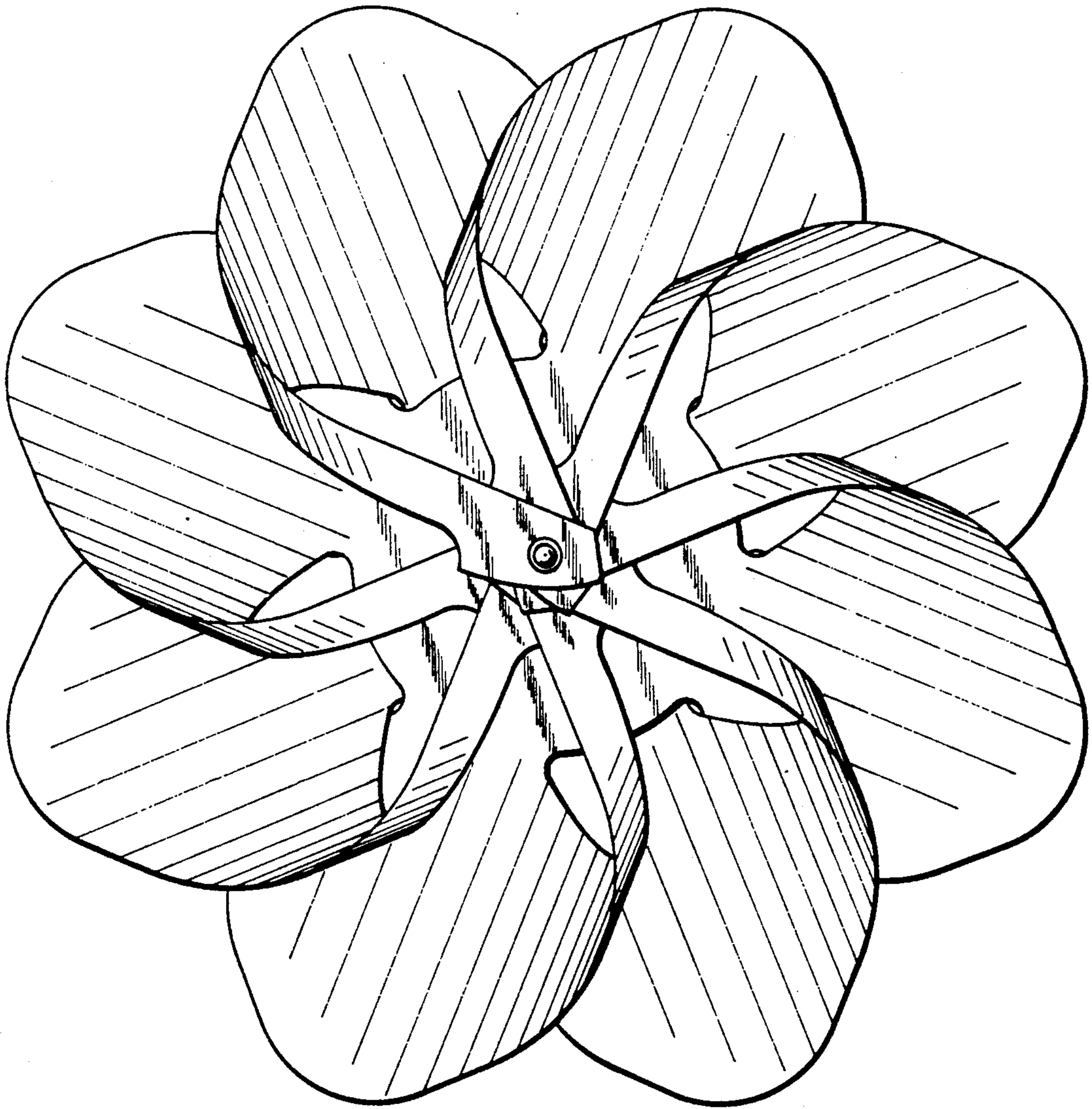

FIG. 4

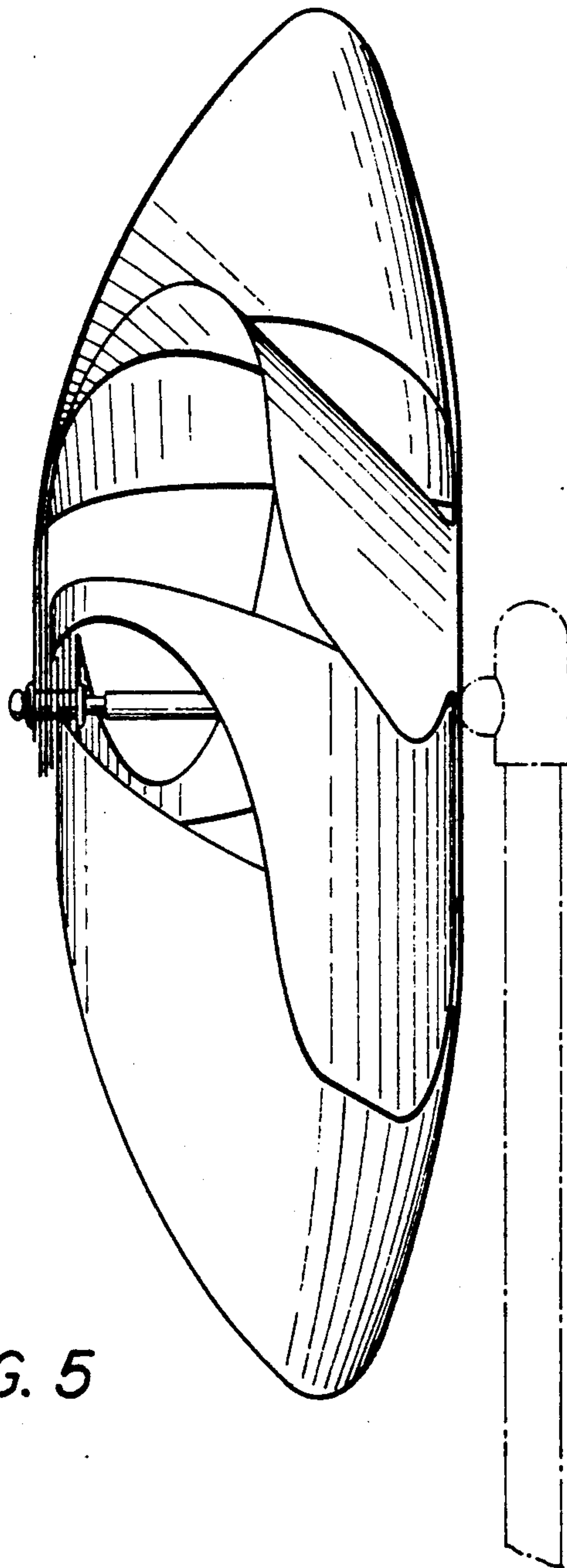

FIG. 5

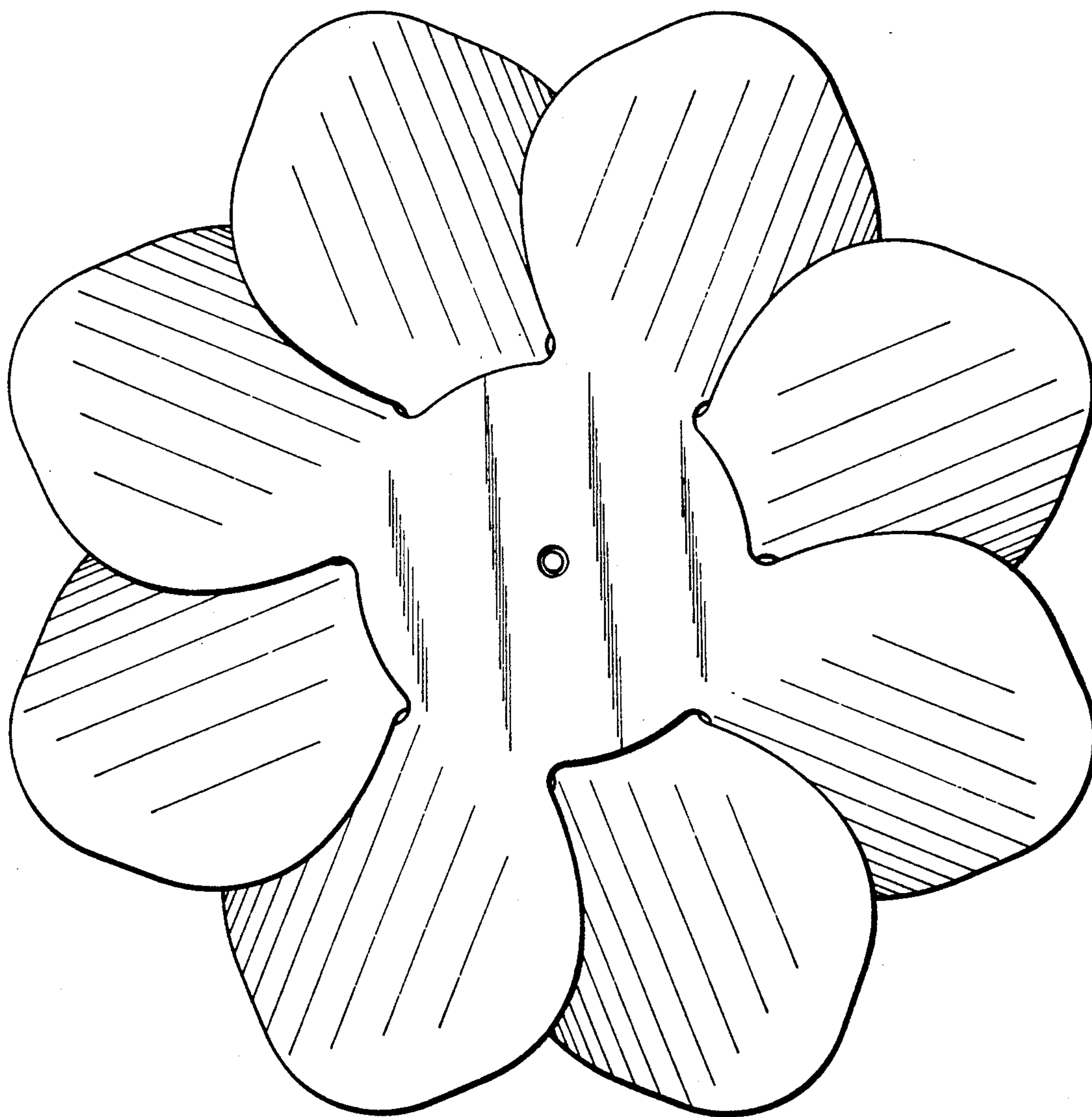

FIG. 6