



US00D331687S

# United States Patent [19]

[11] Patent Number: Des. 331,687

Pujol Gilbert

[45] Date of Patent: \*\* Dec. 15, 1992

[54] **SEPARABLE, COMBINED KITCHEN UTENSIL AND COLLECTOR TRAY**

[75] Inventor: **Josep Maria Pujol Gilbert**, Reus, Spain

[73] Assignee: **Industria Auxiliar Manodomesticos S.A.**, Spain

[\*\*] Term: **14 Years**

[21] Appl. No.: **469,849**

[22] Filed: **Jan. 24, 1990**

[30] **Foreign Application Priority Data**

Jul. 27, 1989 [ES] Spain ..... 119.623  
 [52] U.S. Cl. .... D7/678; D7/665  
 [58] Field of Search ..... D7/678, 665; 99/495, 99/501-506; 241/95, 168, 273.1-273.4, 274

[56] **References Cited**

**U.S. PATENT DOCUMENTS**

D. 167,270 7/1952 Marcus ..... D7/678  
 D. 251,103 2/1979 Puustinen ..... D7/678  
 D. 279,157 6/1985 Gecchelin ..... D7/665  
 4,037,793 7/1977 Puustingon ..... 241/168  
 4,212,431 7/1980 Doyel ..... 241/273.1 X

**OTHER PUBLICATIONS**

Signatures, Grater.

*Primary Examiner*—Terry A. Pfeffer  
*Attorney, Agent, or Firm*—Sughrue, Mion, Zinn, Macpeak & Seas

[57] **CLAIM**

The ornamental design for a separable, combined kitchen utensil and collector tray, as shown and described.

**DESCRIPTION**

FIG. 1 is a front elevational view of a separable, com-

bined kitchen utensil and collector tray showing my new design;

FIG. 2 is a rear elevational view thereof;

FIG. 3 is a left side elevational view thereof, the opposite side being a mirror image thereof;

FIG. 4 is a front, top, left side perspective view of the collector tray;

FIG. 5 is a top plan view of FIG. 4;

FIG. 6 is a bottom plan view of FIG. 4;

FIG. 7 is a rear elevational view of FIG. 4;

FIG. 8 is a front elevational view of FIG. 4;

FIG. 9 is a left side elevational view of FIG. 4;

FIG. 10 is a front, top, left side perspective view of the grating lid;

FIG. 11 is a top plan view of FIG. 10;

FIG. 12 is a bottom plan view of FIG. 10;

FIG. 13 is a front elevational view of an alternate embodiment of FIG. 1, the remaining views being similar to the first embodiment except for the cheese grater lid;

FIG. 14 is a front, top, left side perspective view of the cheese grater lid;

FIG. 15 is a top plan view of FIG. 14;

FIG. 16 is a bottom plan view of FIG. 14;

FIG. 17 is a front elevational view of an alternate embodiment of FIG. 1, the remaining views being similar to the first embodiment except for the slicing lid;

FIG. 18 is a front, top, left side perspective view of the slicing lid;

FIG. 19 is a top plan view of FIG. 18;

FIG. 20 is a bottom plan view of FIG. 18;

FIG. 21 is a front elevational view of an alternate embodiment of FIG. 1, the bottom view being similar to the first embodiment;

FIG. 22 is a rear elevational view of FIG. 21;

FIG. 23 is a left side elevational view of FIG. 21, the opposite side being identical;

FIG. 24 is a front, top, left side perspective view of the squeezer lid;

FIG. 25 is a top plan view of FIG. 24; and,

FIG. 26 is a bottom plan view of FIG. 24.

The lids are shown separately for clarity of illustration.

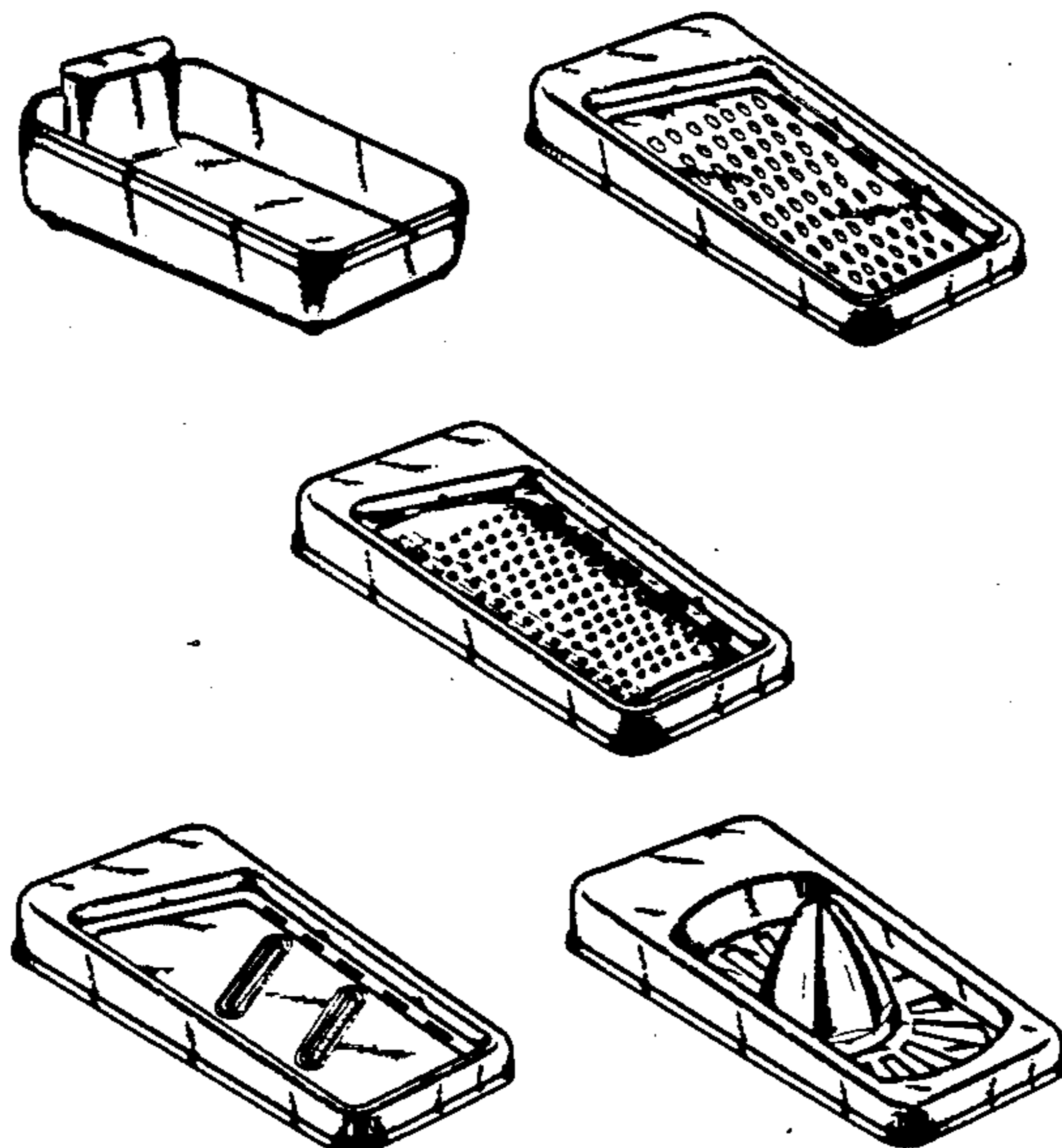

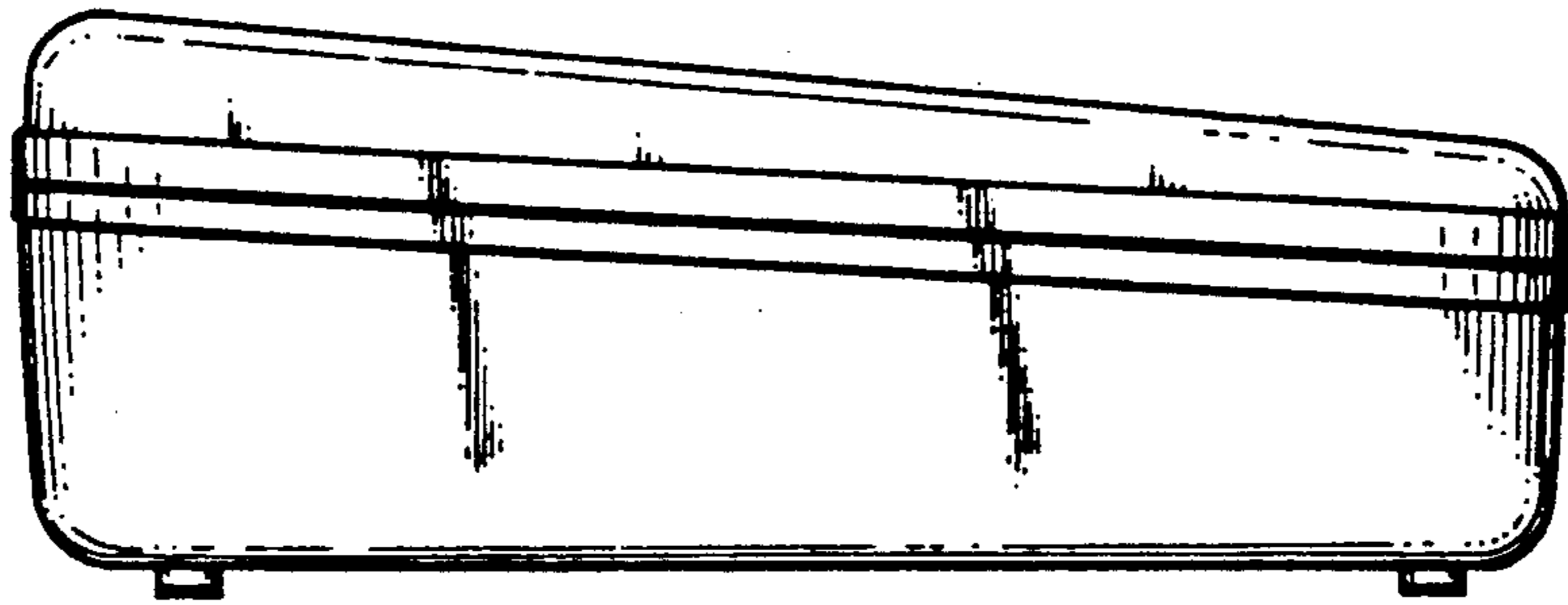

FIG. 3

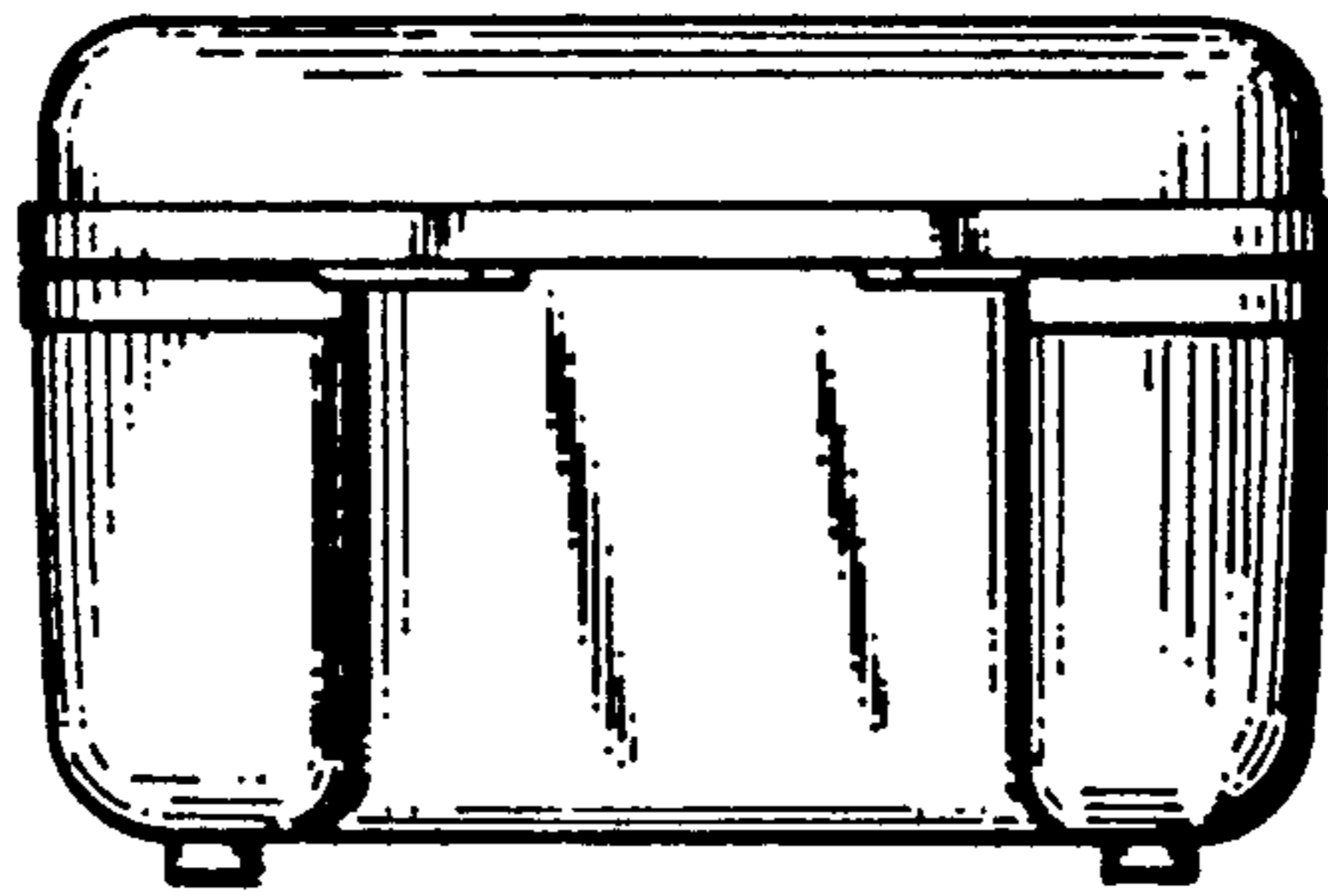

FIG. 2

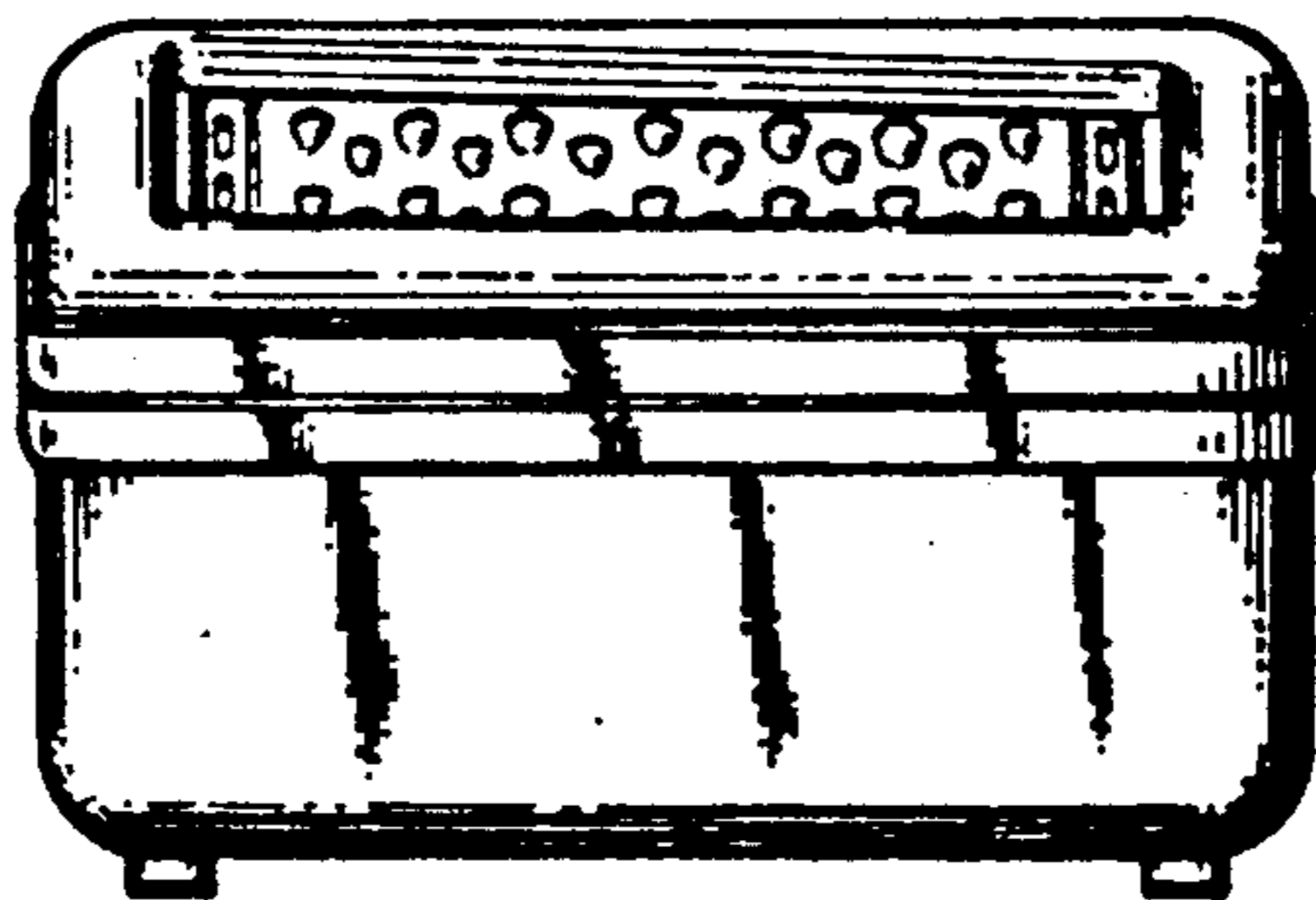

FIG. 1

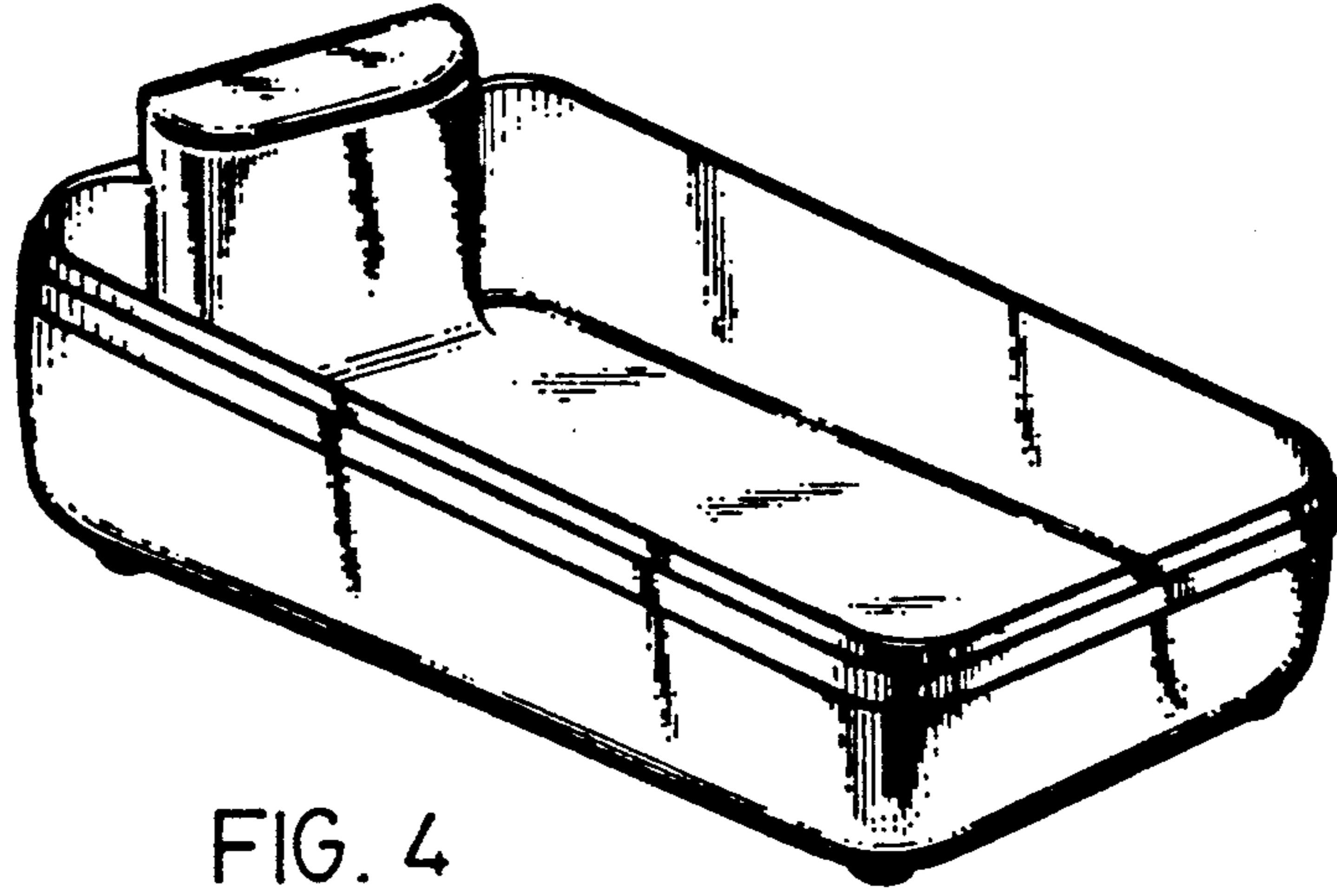

FIG. 4

FIG. 5

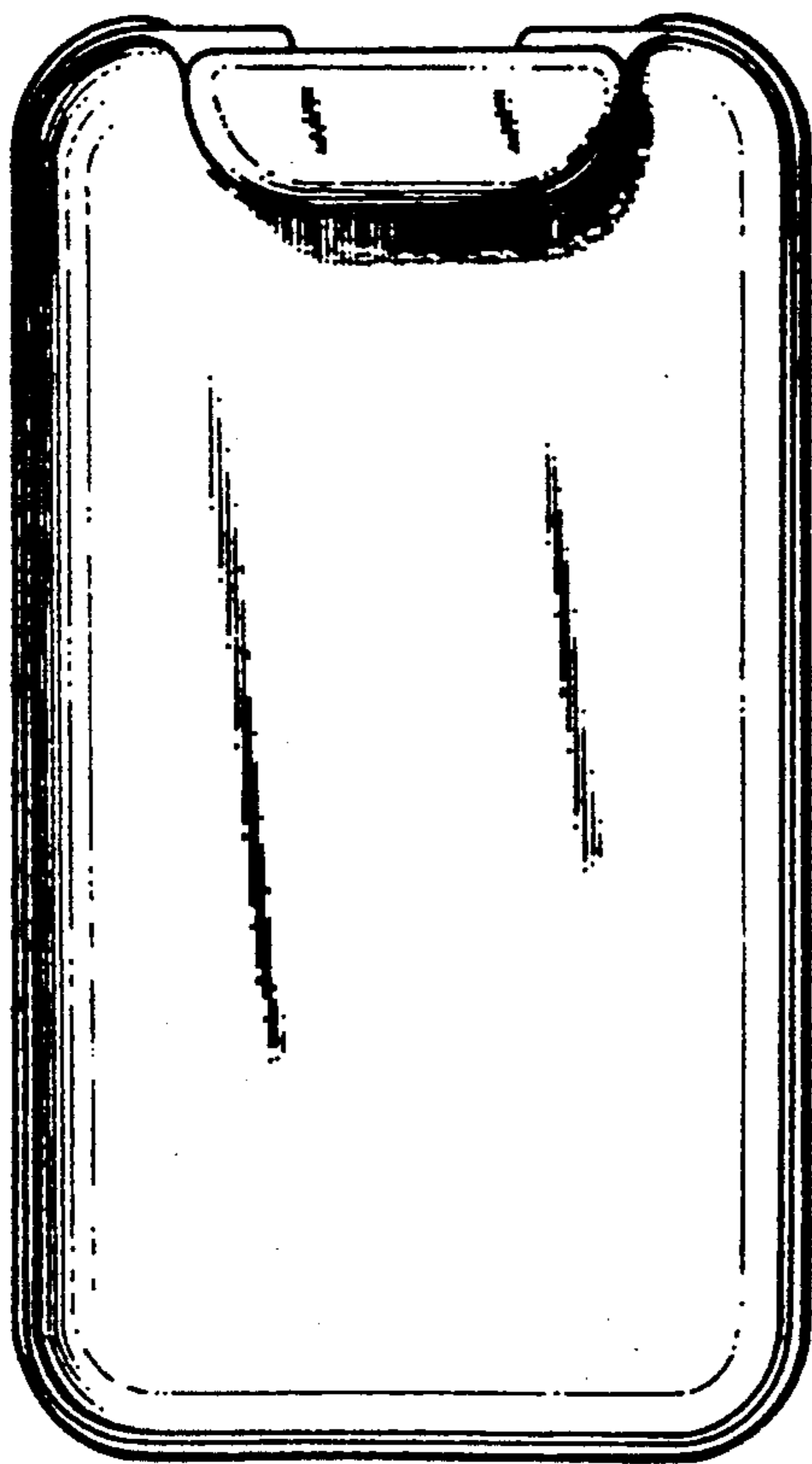
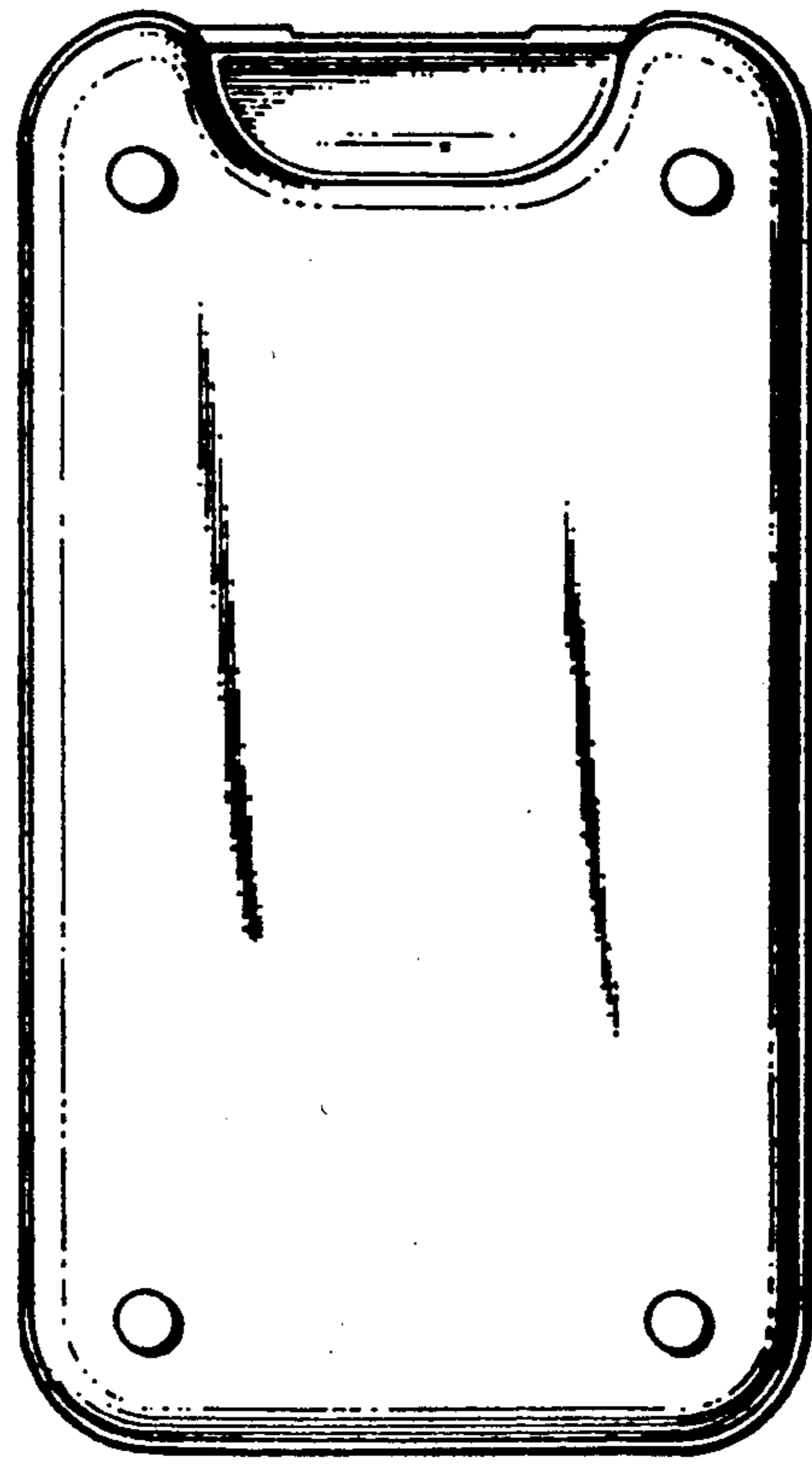

FIG. 6



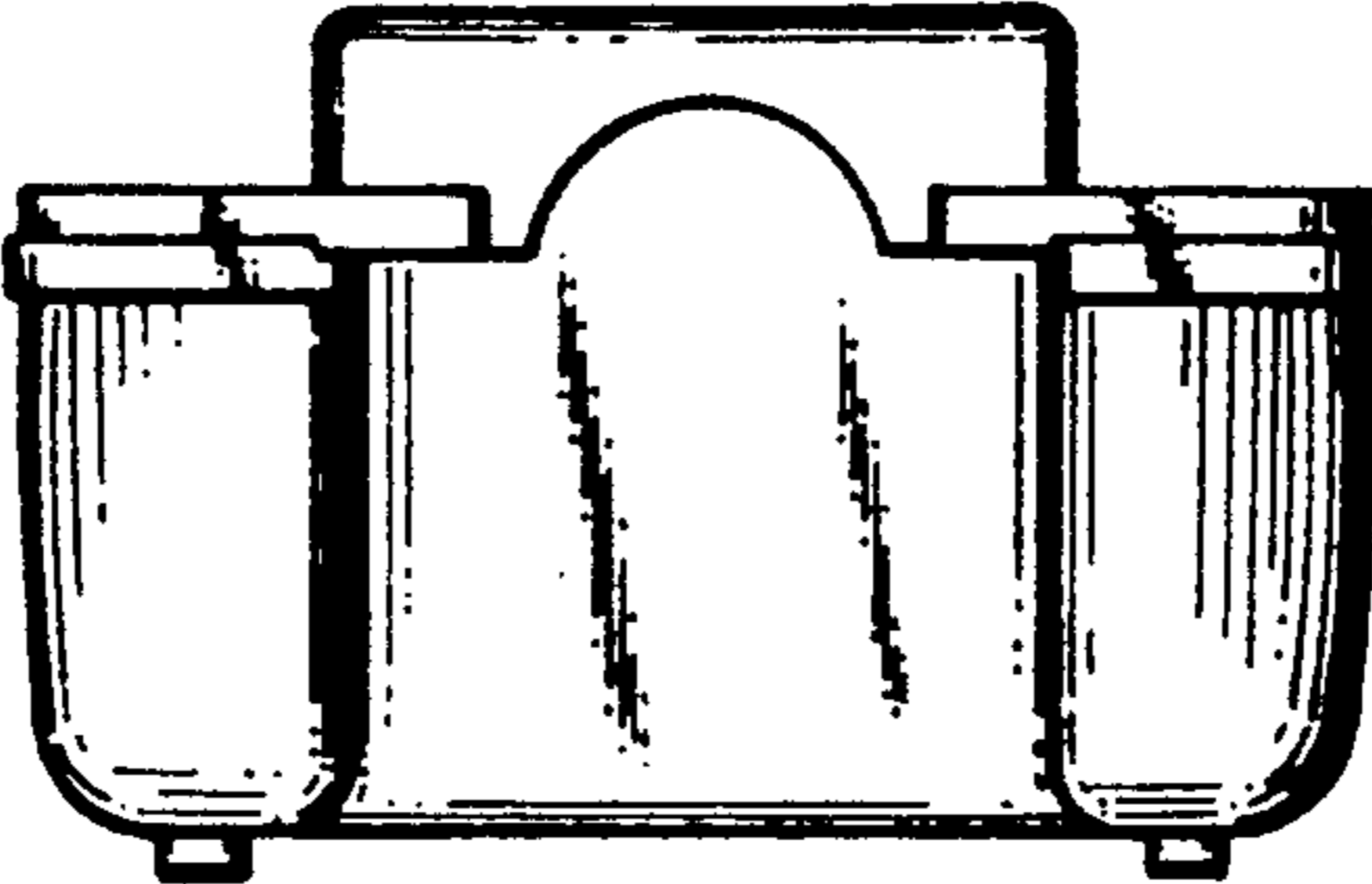

FIG. 7

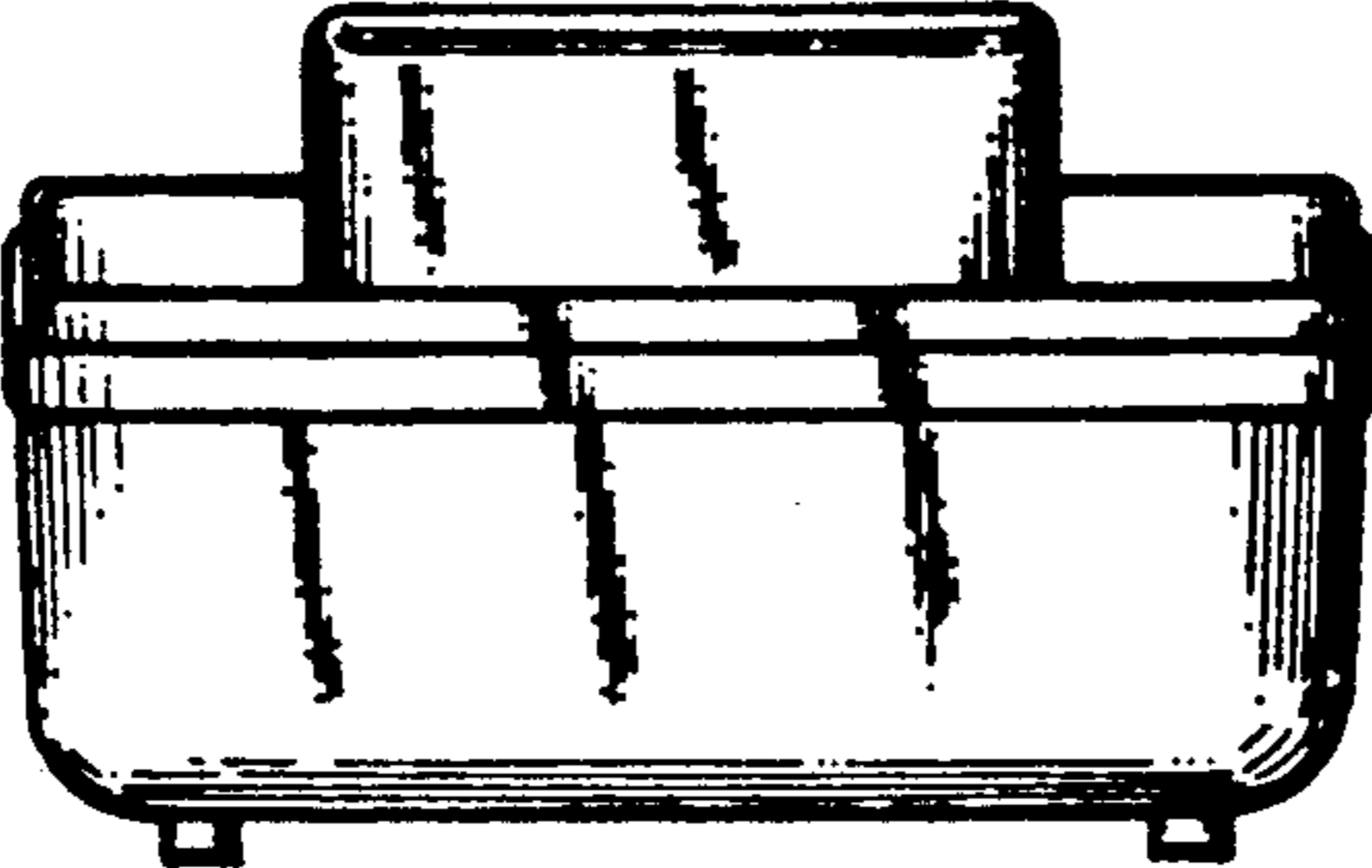

FIG. 8

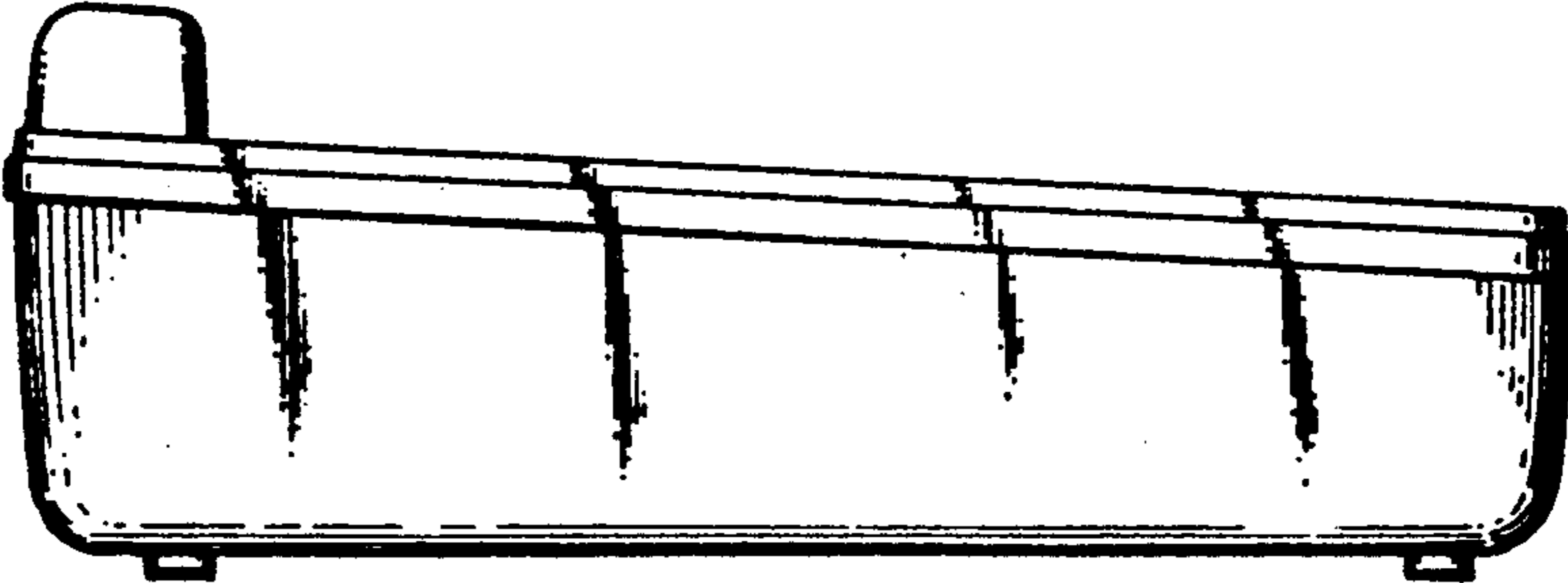

FIG. 9

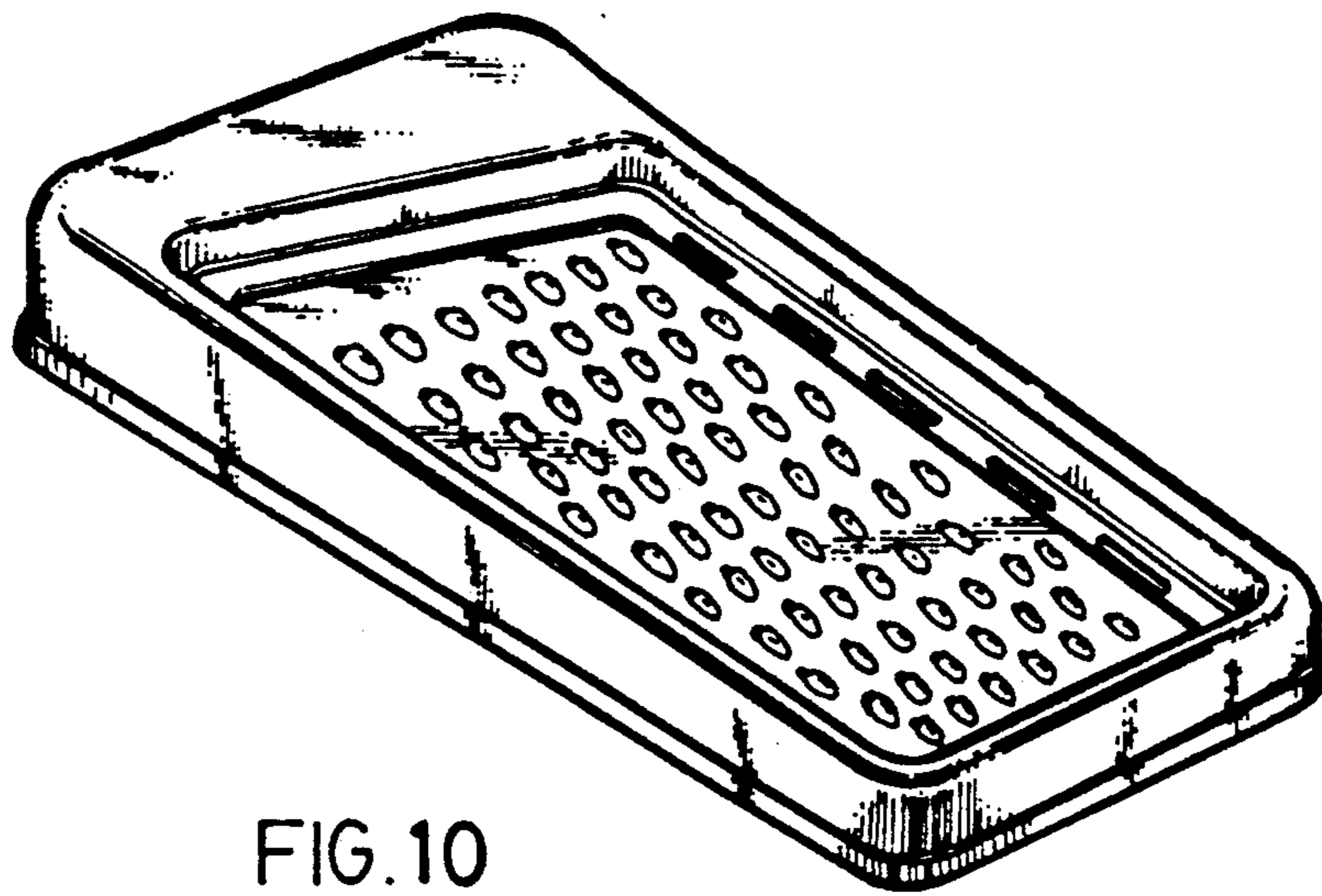

FIG. 10

FIG. 11

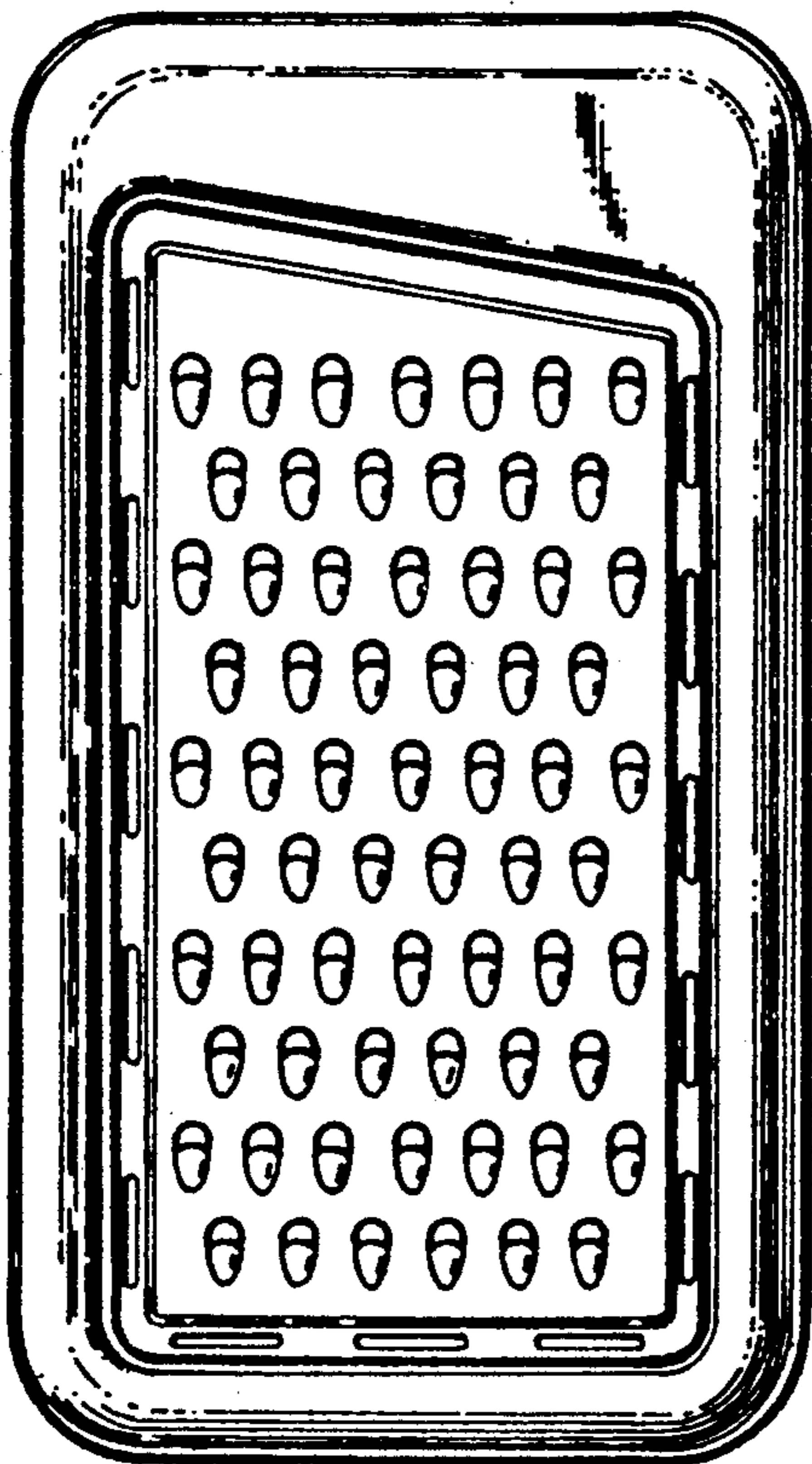
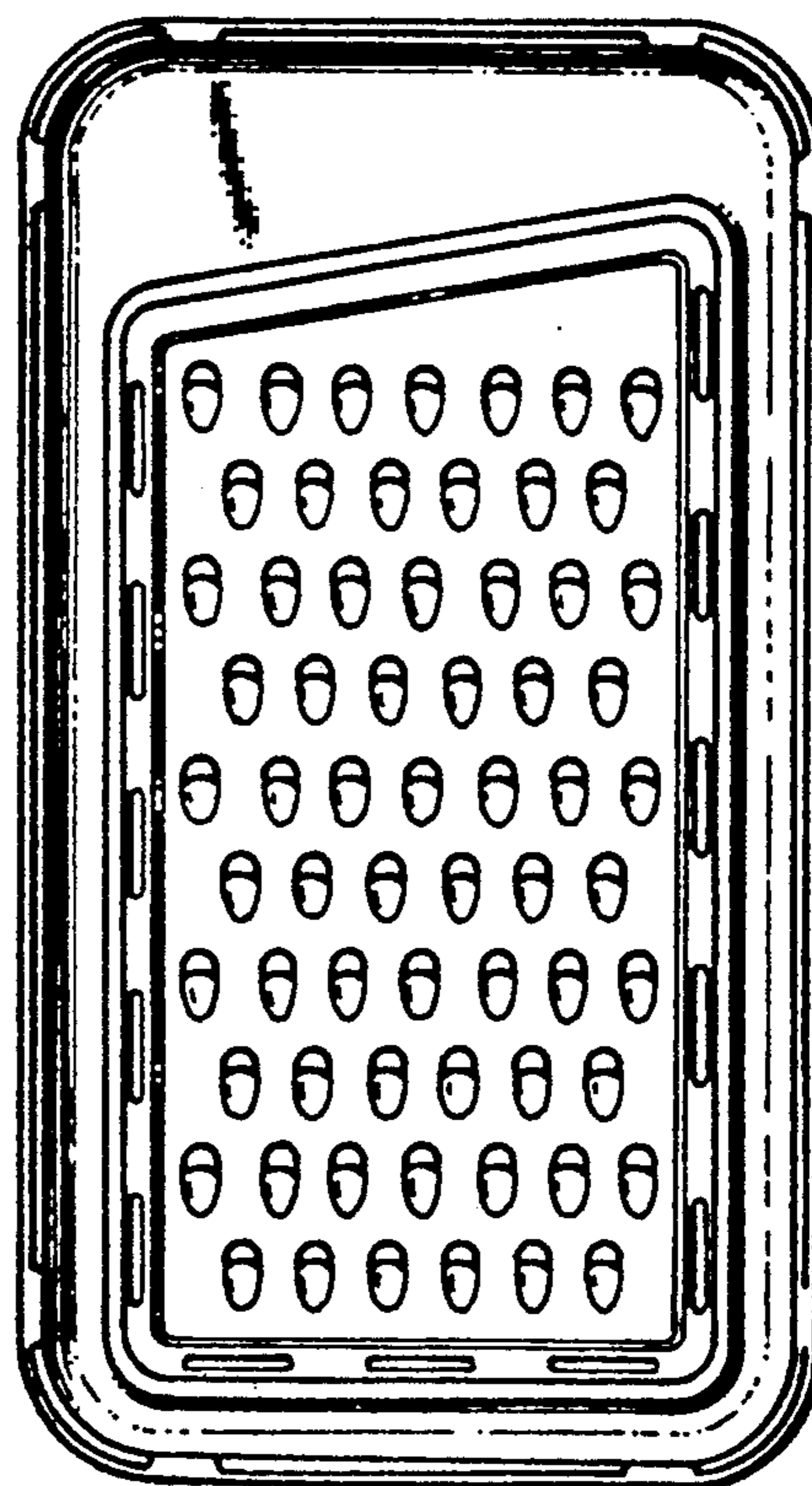

FIG. 12



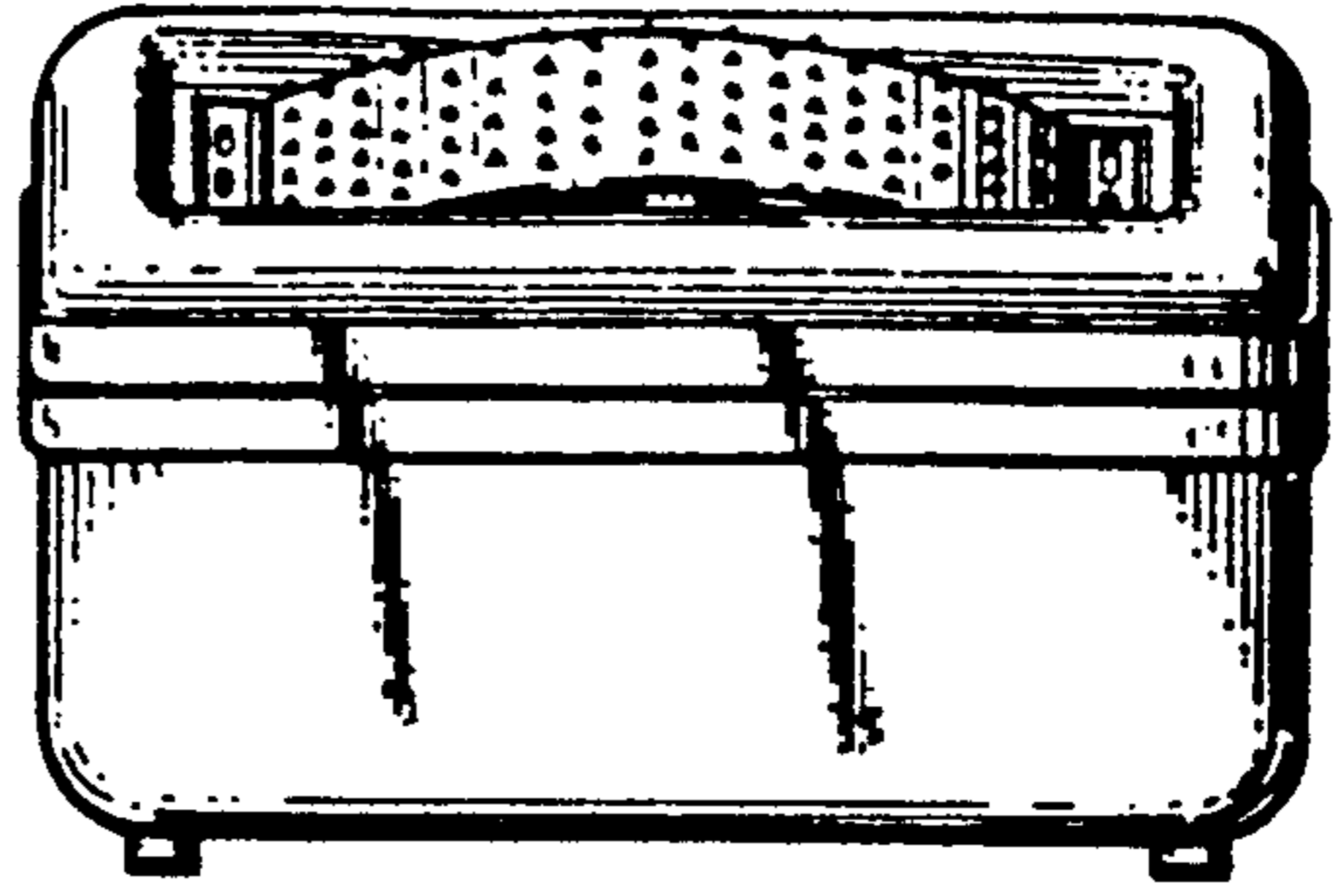

FIG. 13

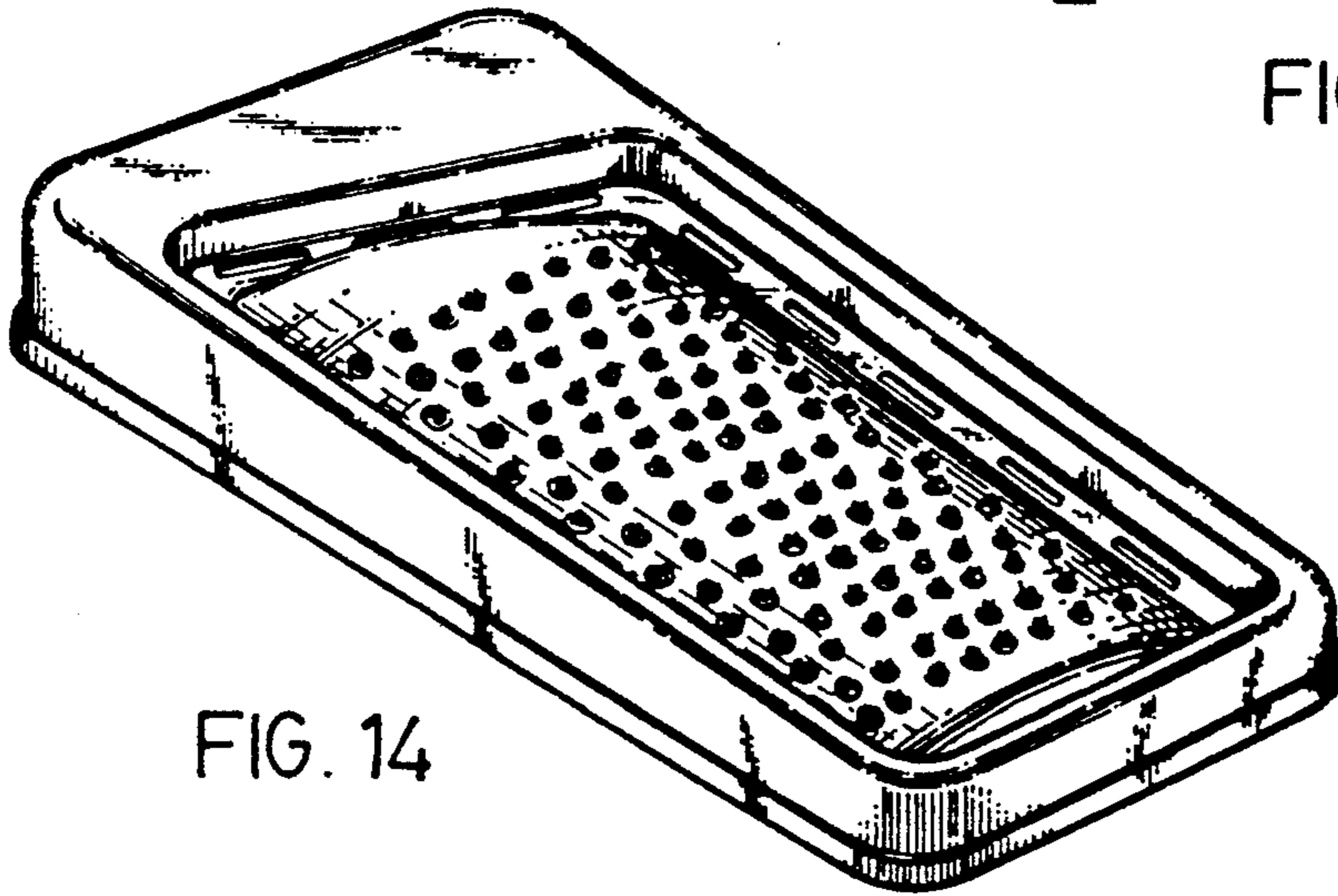

FIG. 14

FIG. 15

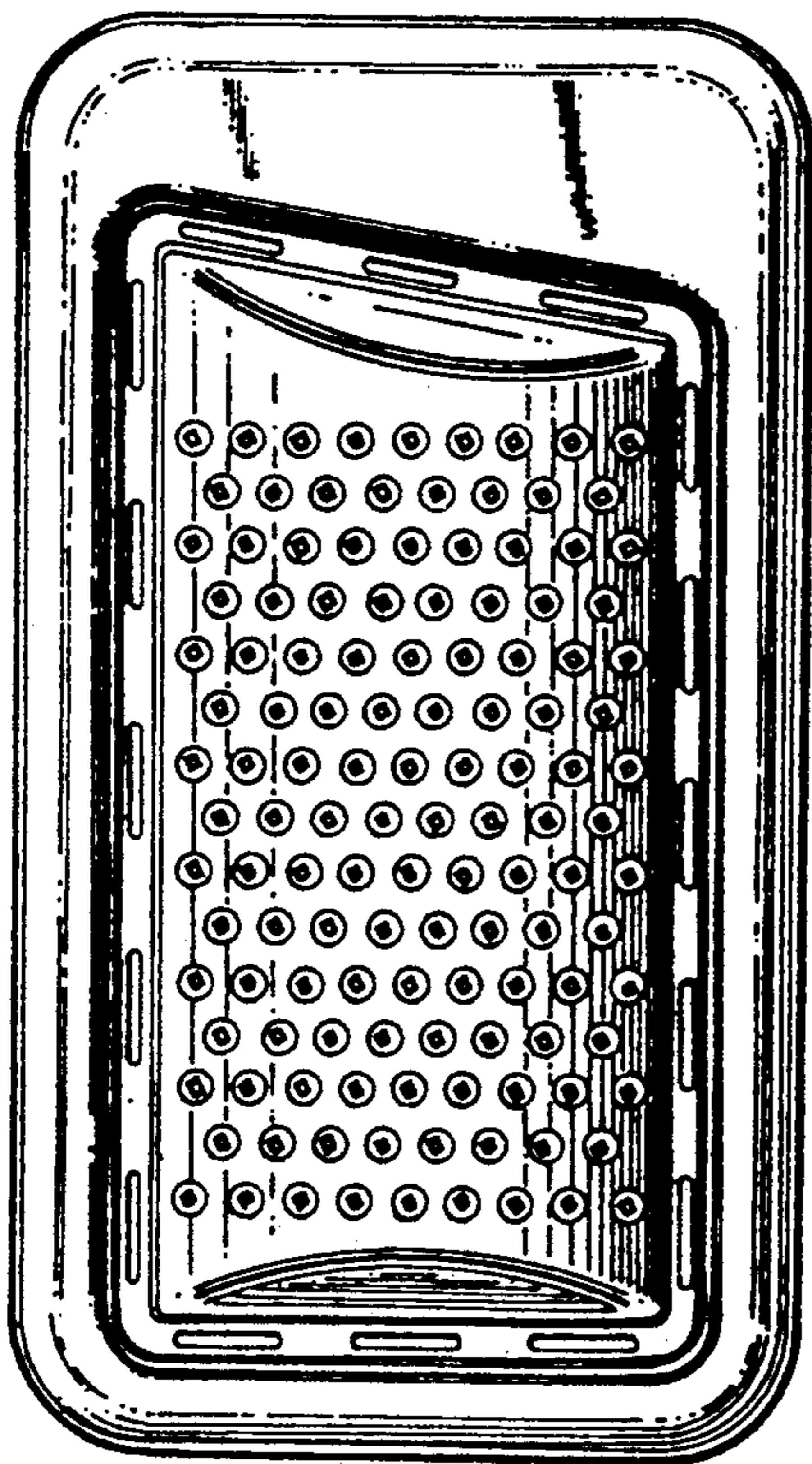
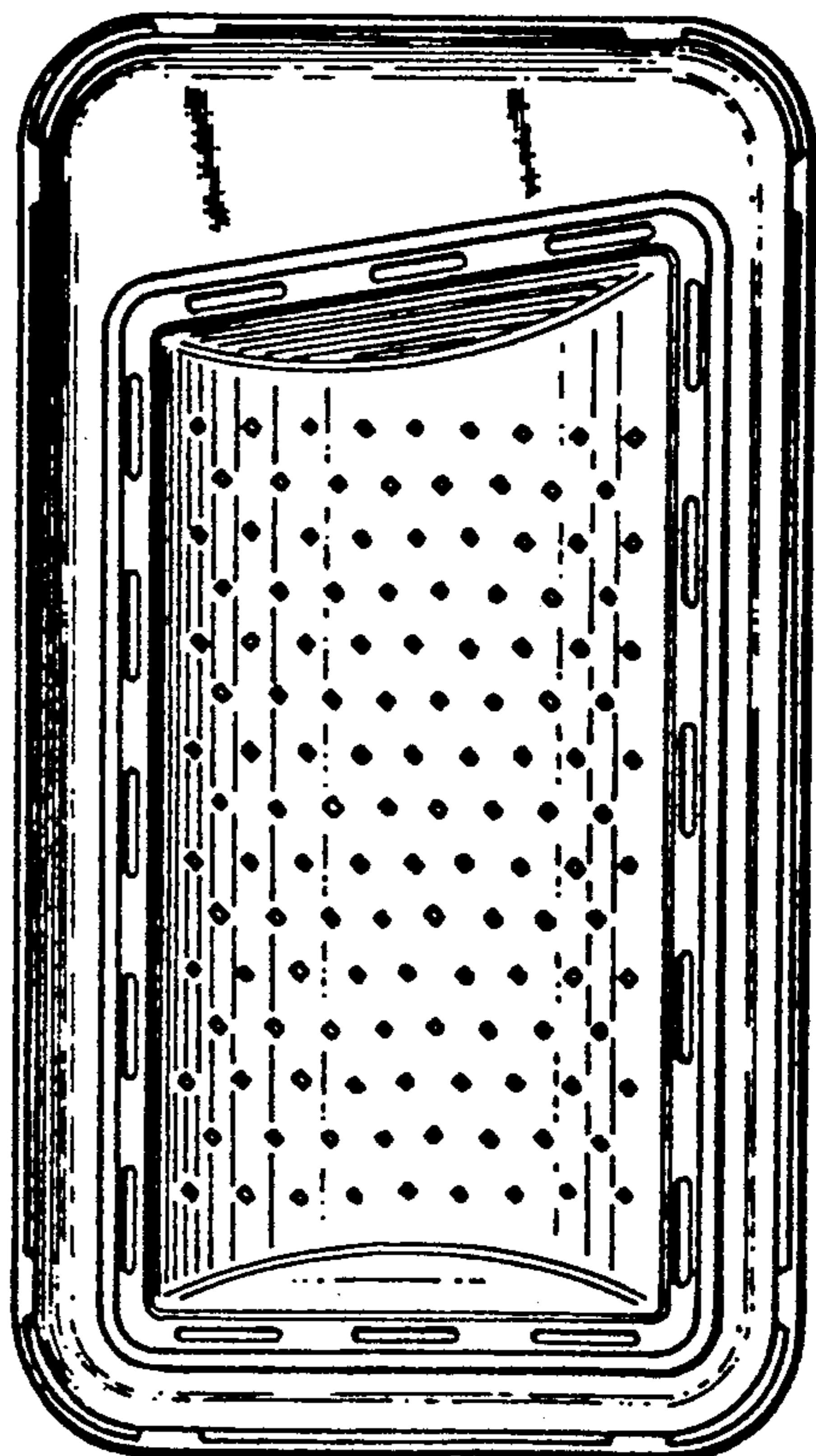

FIG. 16



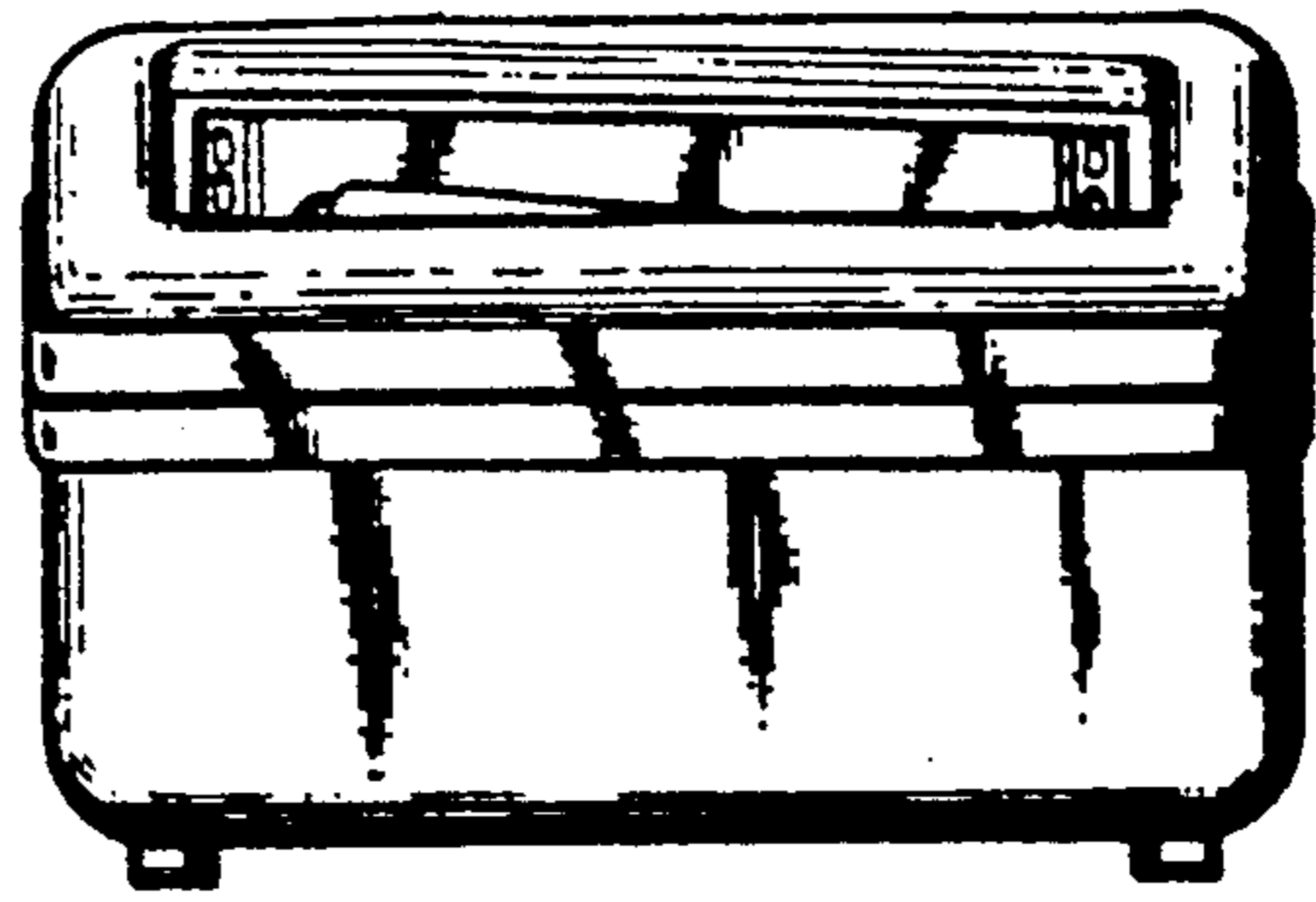

FIG. 17

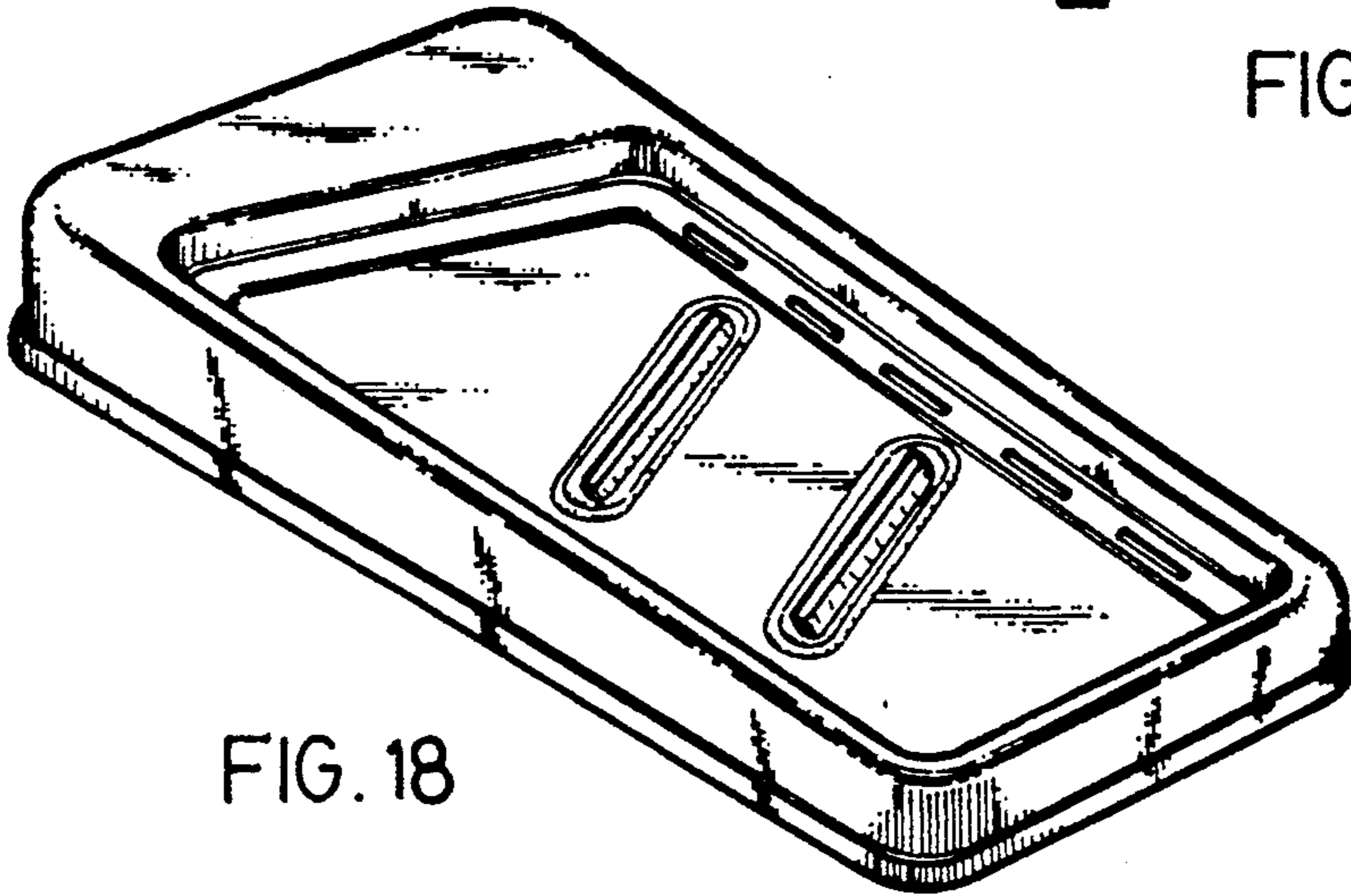

FIG. 18

FIG. 19

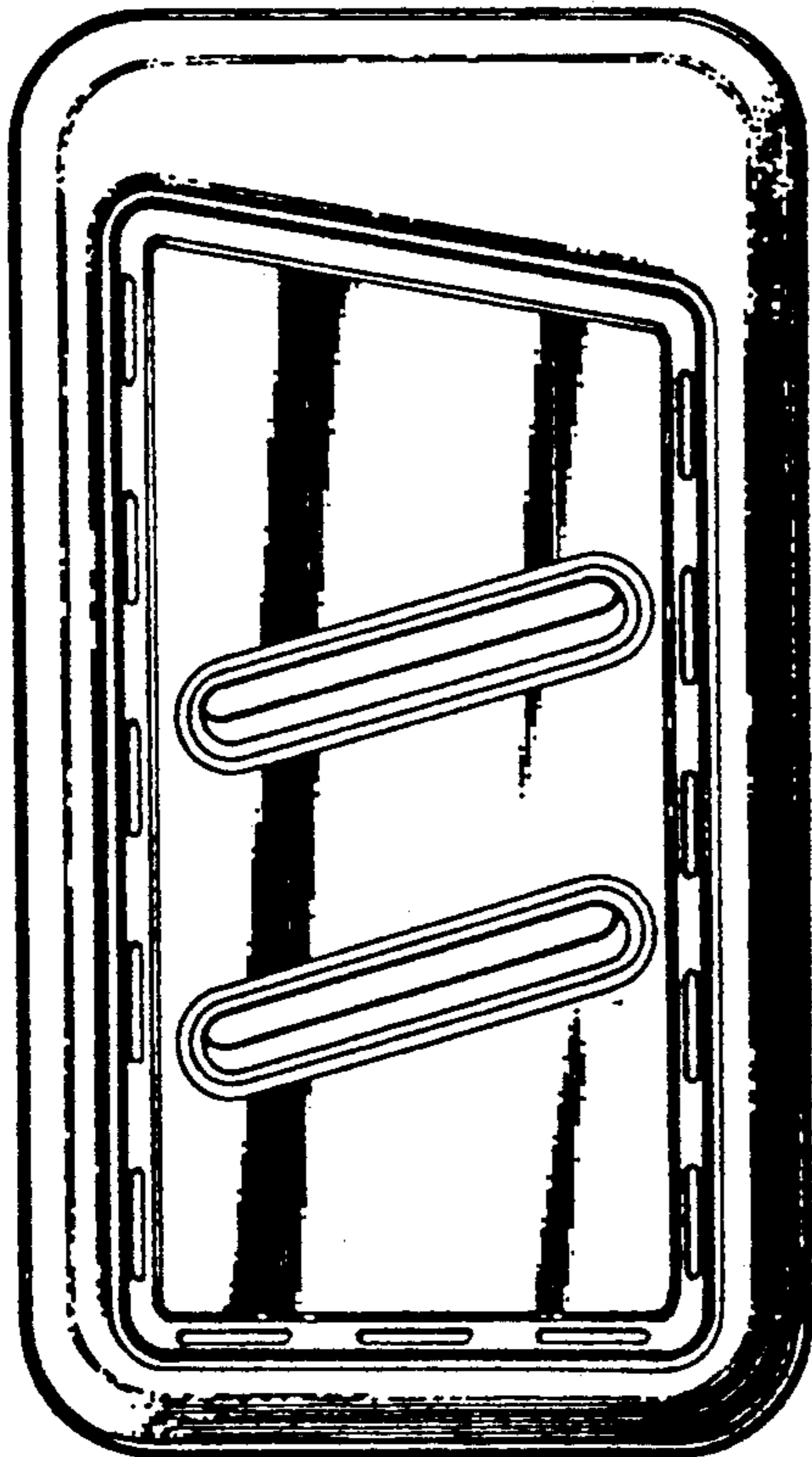
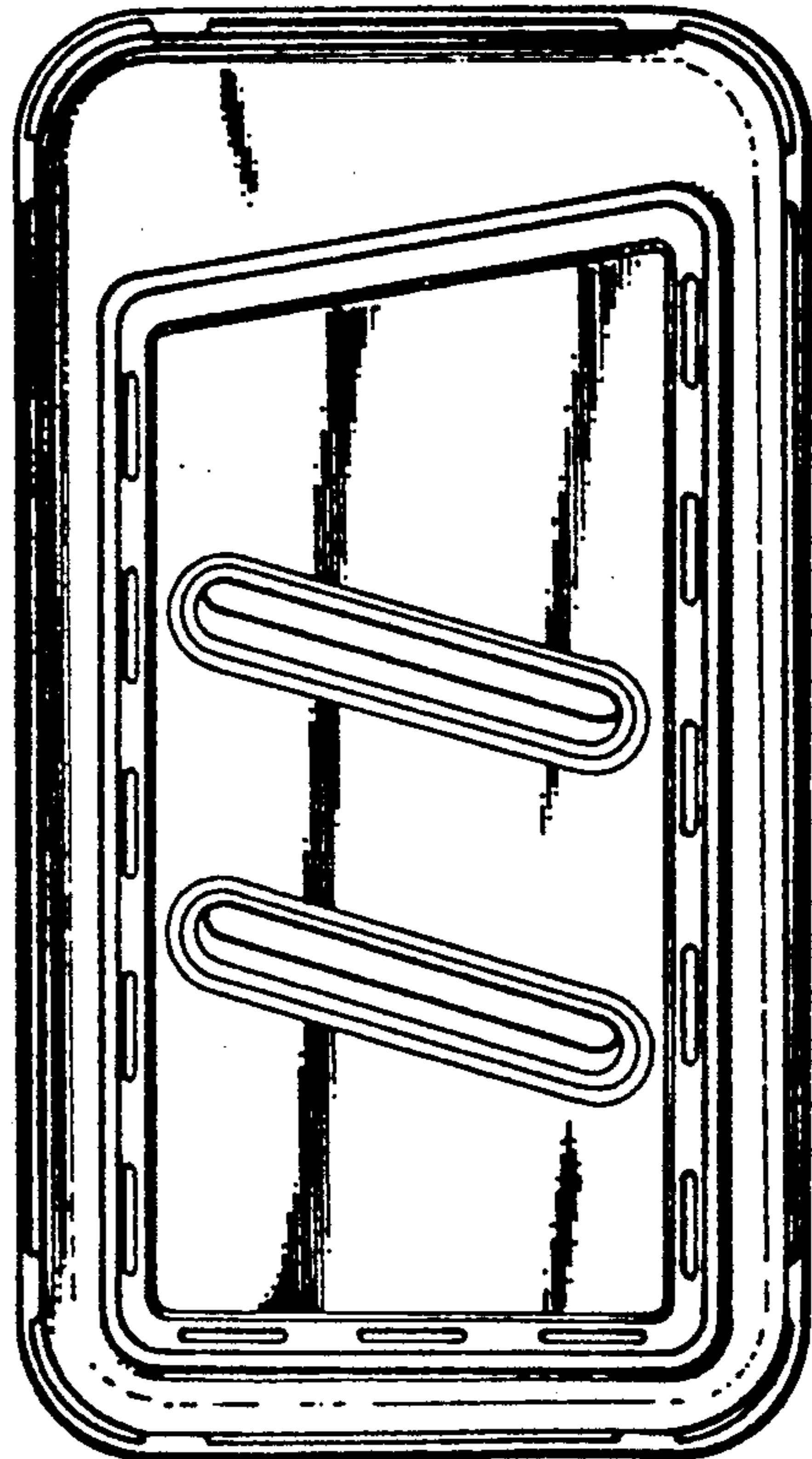

FIG. 20



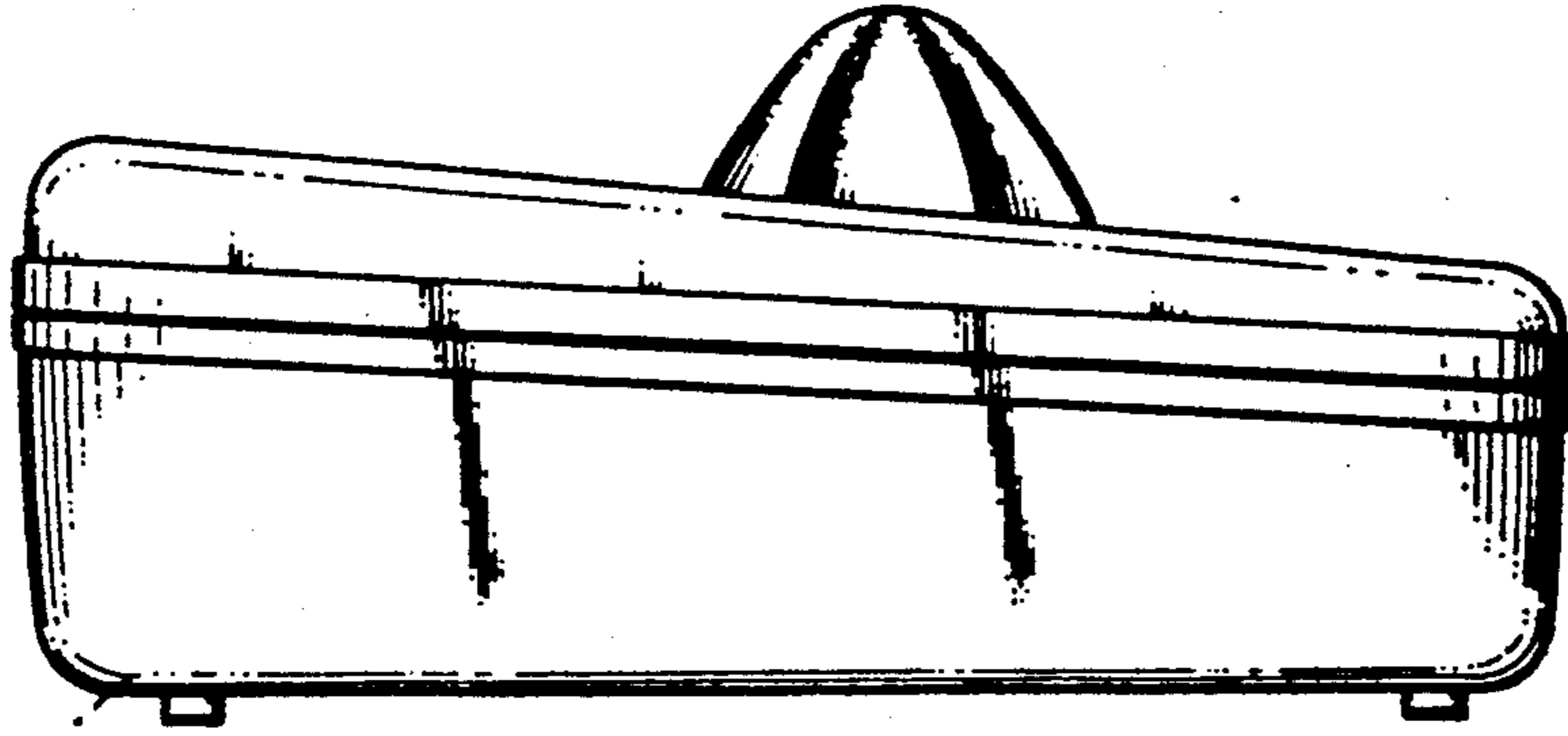

FIG. 23

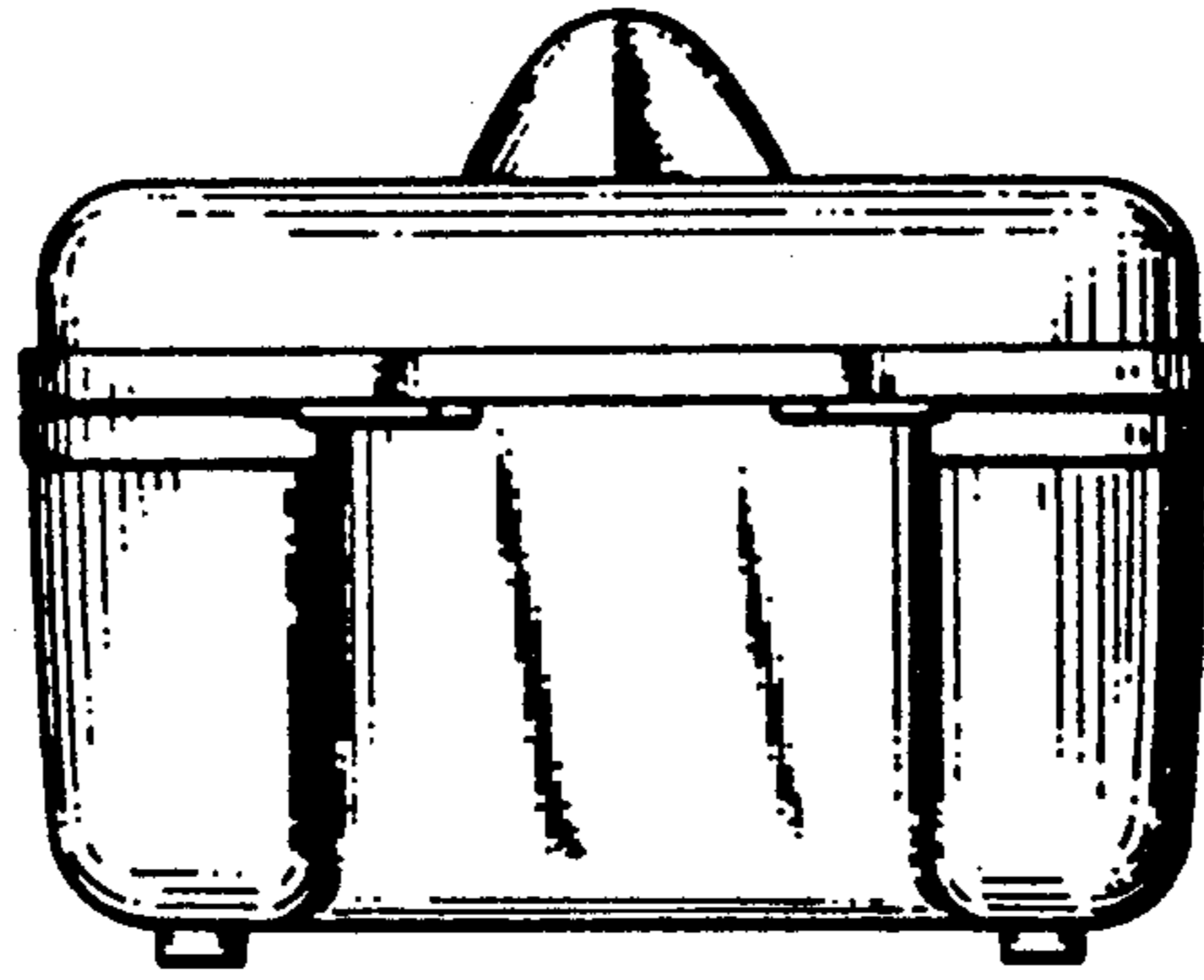

FIG. 22

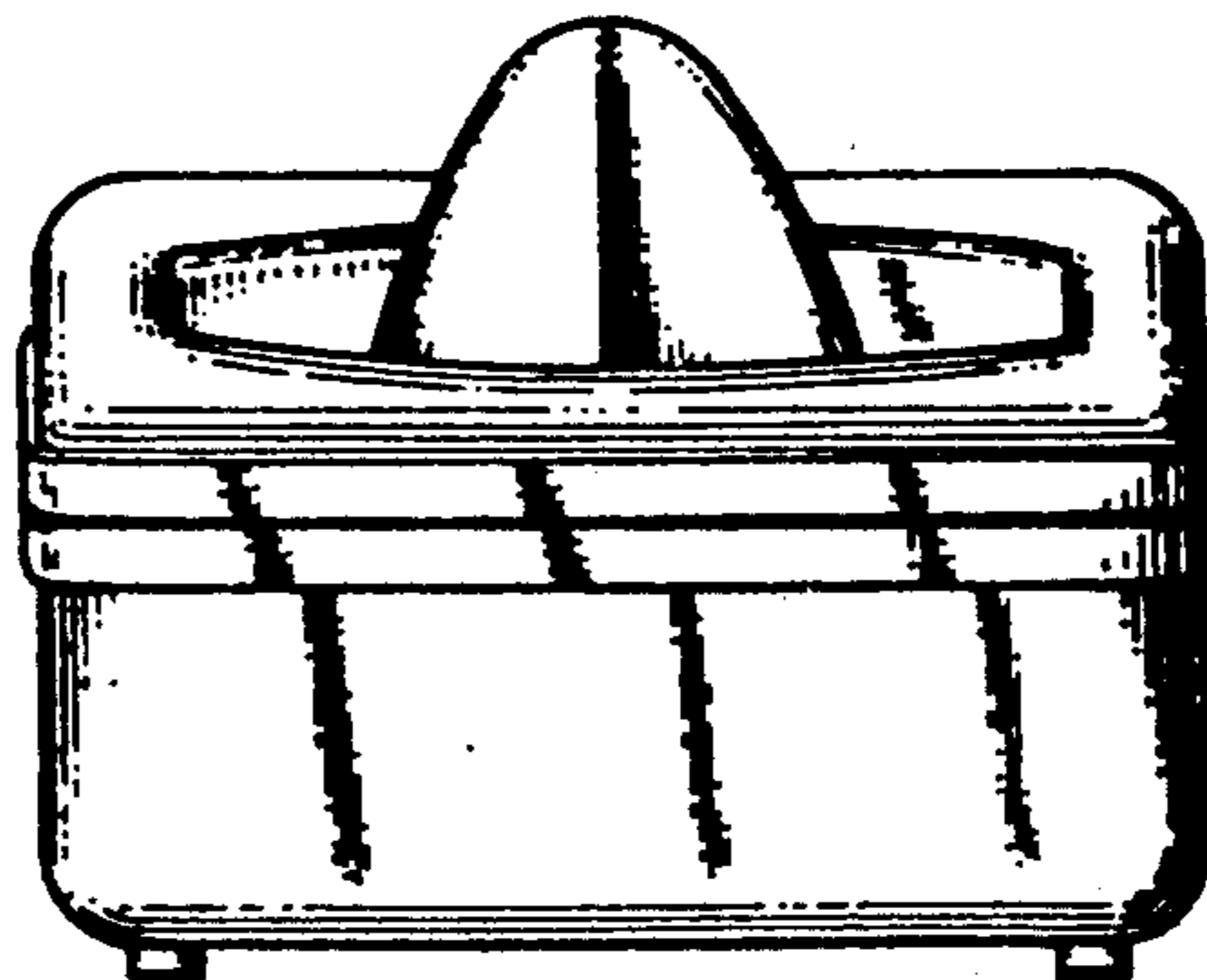

FIG. 21



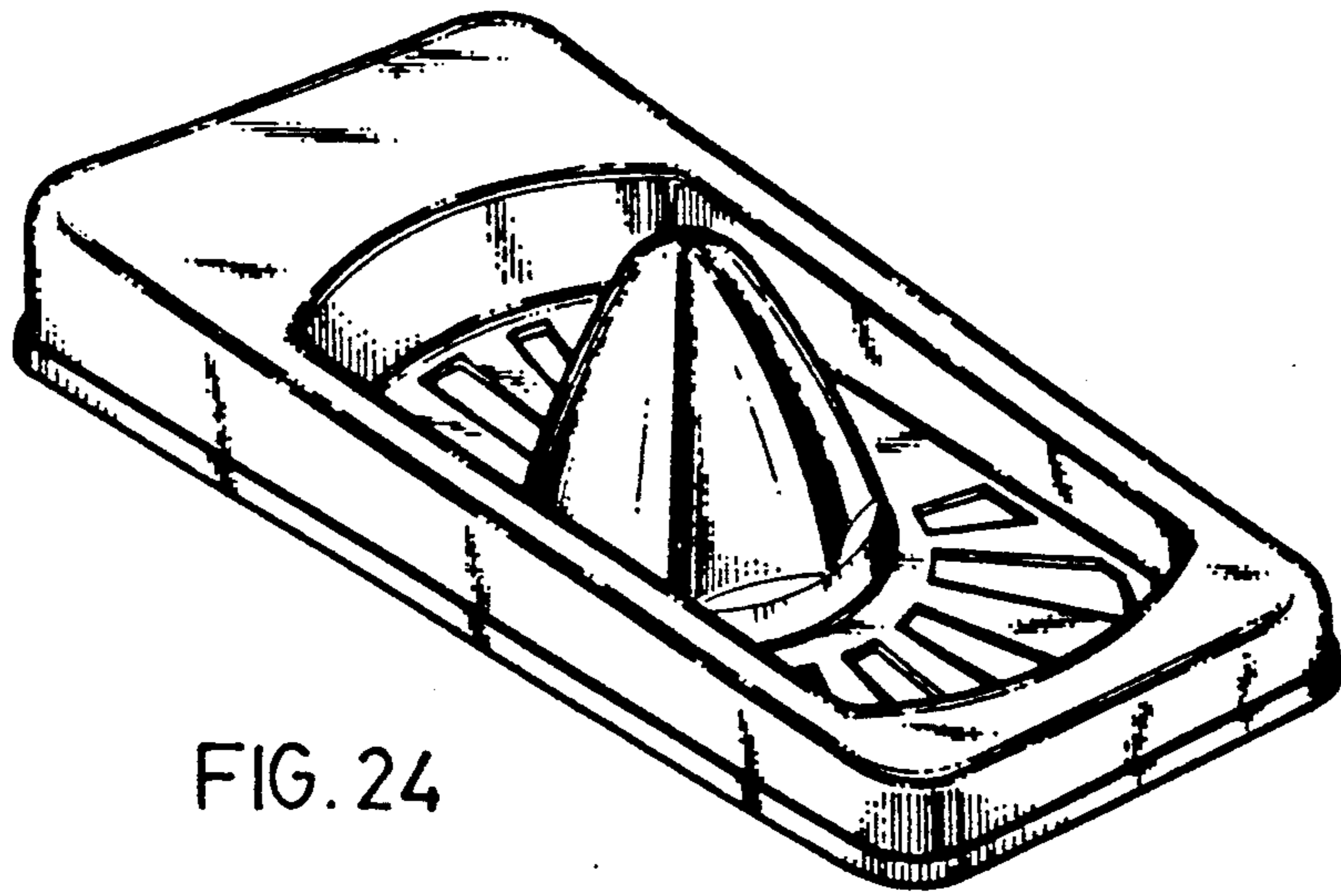

FIG. 24

FIG. 25

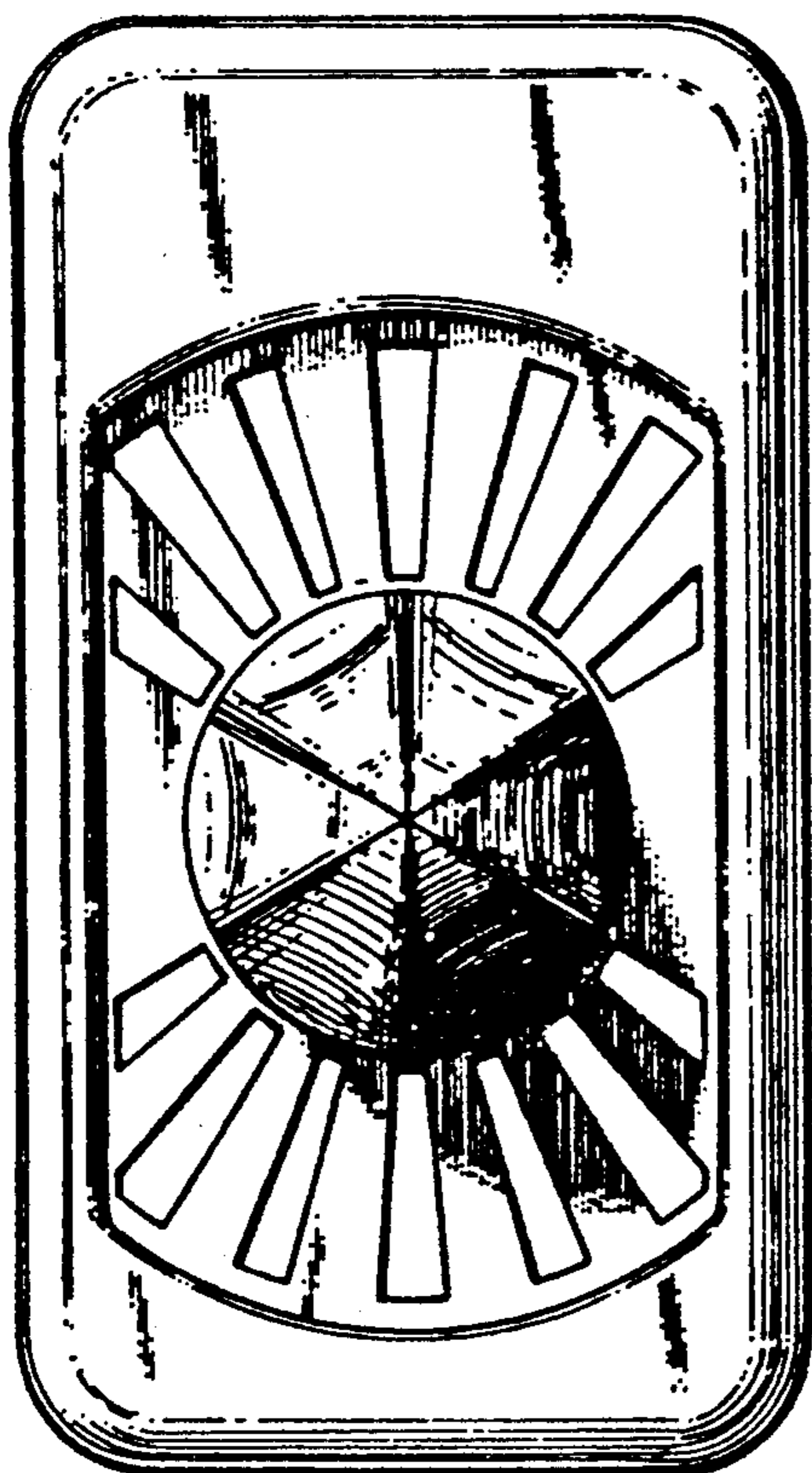

FIG. 26

