



US00D331670S

United States Patent [19]

[11] Patent Number: **Des. 331,670**

Soucy et al.

[45] Date of Patent: **** Dec. 15, 1992**

[54] **ADJUSTABLE PLANT AND KNICKKNACK STAND COMBINATION**

D. 300,699	4/1989	Penrod	D6/405
699,154	5/1902	De Force	47/39
1,897,905	2/1933	Johnson	47/39

[76] Inventors: **Carl Soucy**, 23 Cianci Ave., Plainville; **Gary Roy**, 22 South St., Bristol, both of Conn. 06062

Primary Examiner—B. J. Bullock
Attorney, Agent, or Firm—Chilton, Alix & Van Kirk

[**] Term: **14 Years**

[57] **CLAIM**

[21] Appl. No.: **563,964**

The ornamental design of an adjustable plant and knickknack stand combination, as shown.

[22] Filed: **Aug. 7, 1990**

DESCRIPTION

[52] U.S. Cl. **D6/405; D6/479**

[58] Field of Search **D6/405, 476, 464, 465, D6/460, 461, 479; 211/74, 77, 131; 47/39; 108/92, 94, 95**

FIG. 1 is a front elevational view of an adjustable plant and knickknack stand combination showing our new design;

FIG. 2 is a right side elevational view thereof;

FIG. 3 is a left side elevational view thereof;

FIG. 4 is a back elevational view thereof;

FIG. 5 is a top plan view thereof;

FIG. 6 is a bottom plan view thereof;

FIG. 7 is a front elevational view thereof with the shelves in an alternate arrangement; and,

FIG. 8 is a right side elevational view of FIG. 7.

[56] References Cited

U.S. PATENT DOCUMENTS

D. 78,584	5/1929	Niemczyk et al.	D6/460
D. 166,528	4/1952	Cole	D6/460
D. 244,571	6/1977	Cowan, Jr.	D6/405
D. 245,131	7/1977	Johnsson	D6/405
D. 247,937	5/1978	Dilyard	D6/405

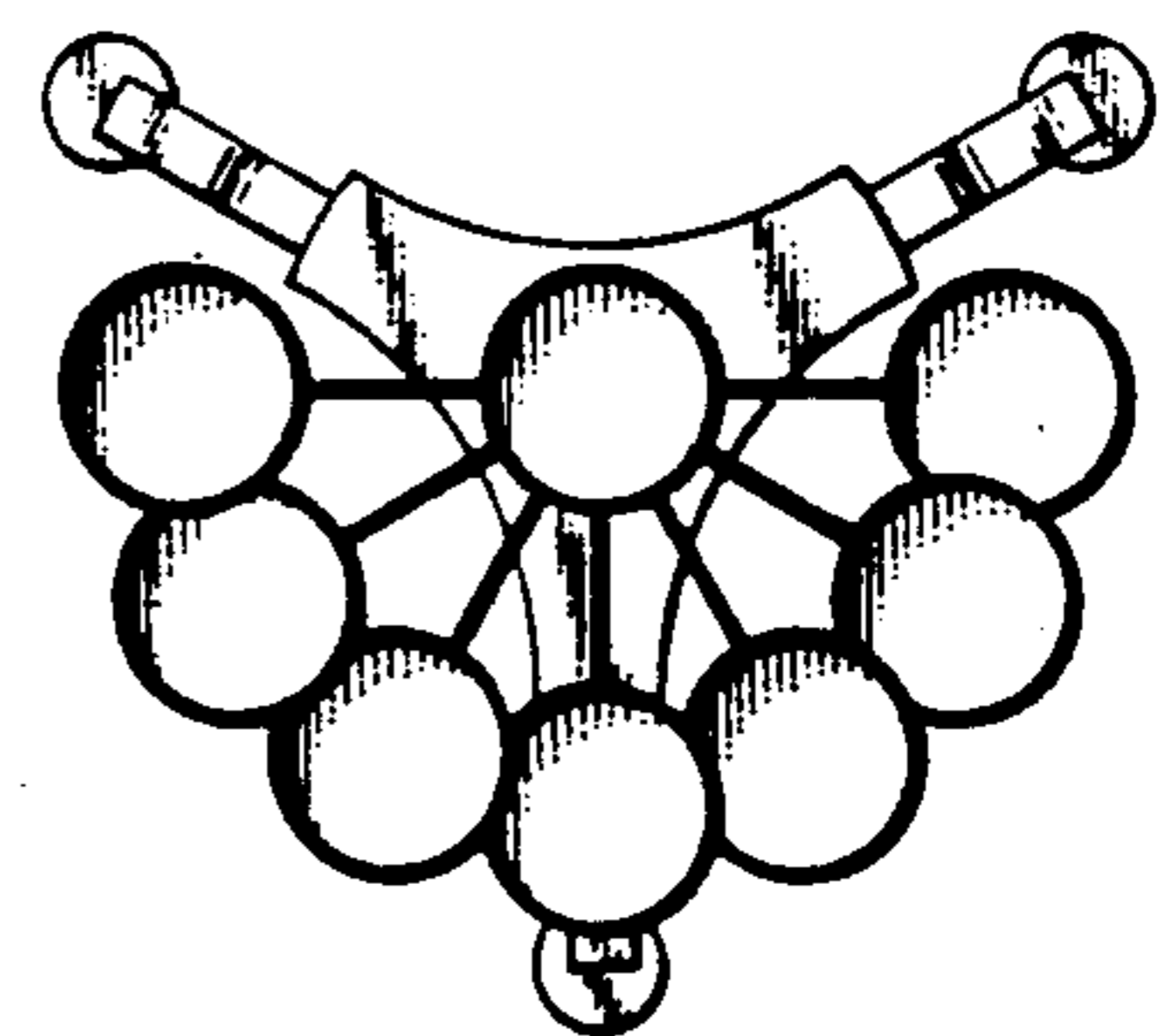
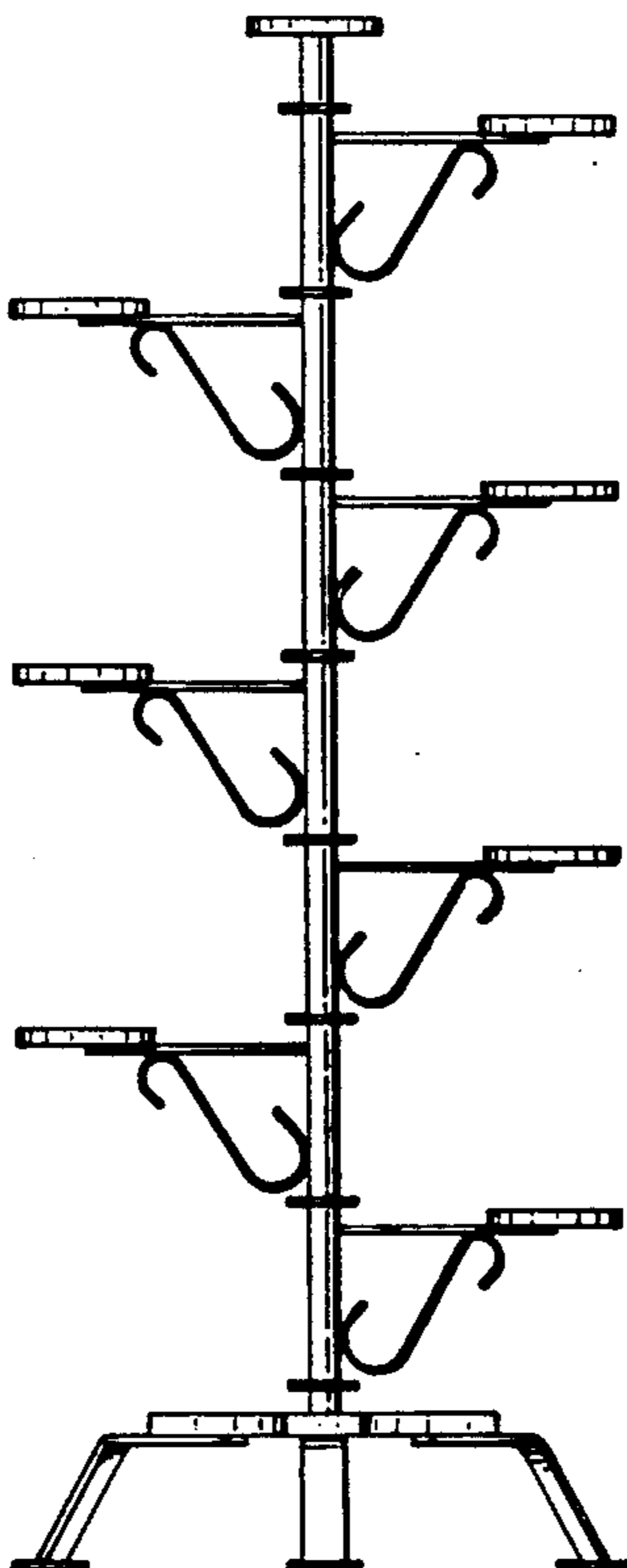
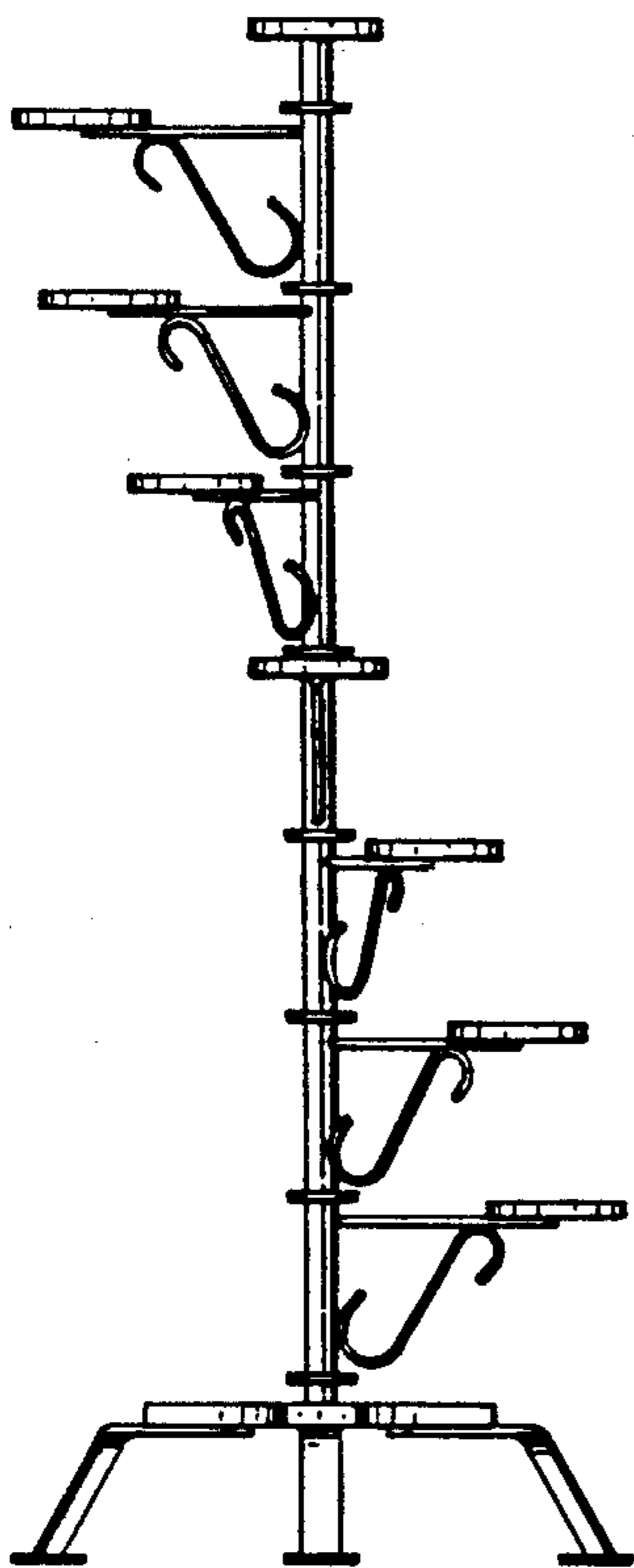

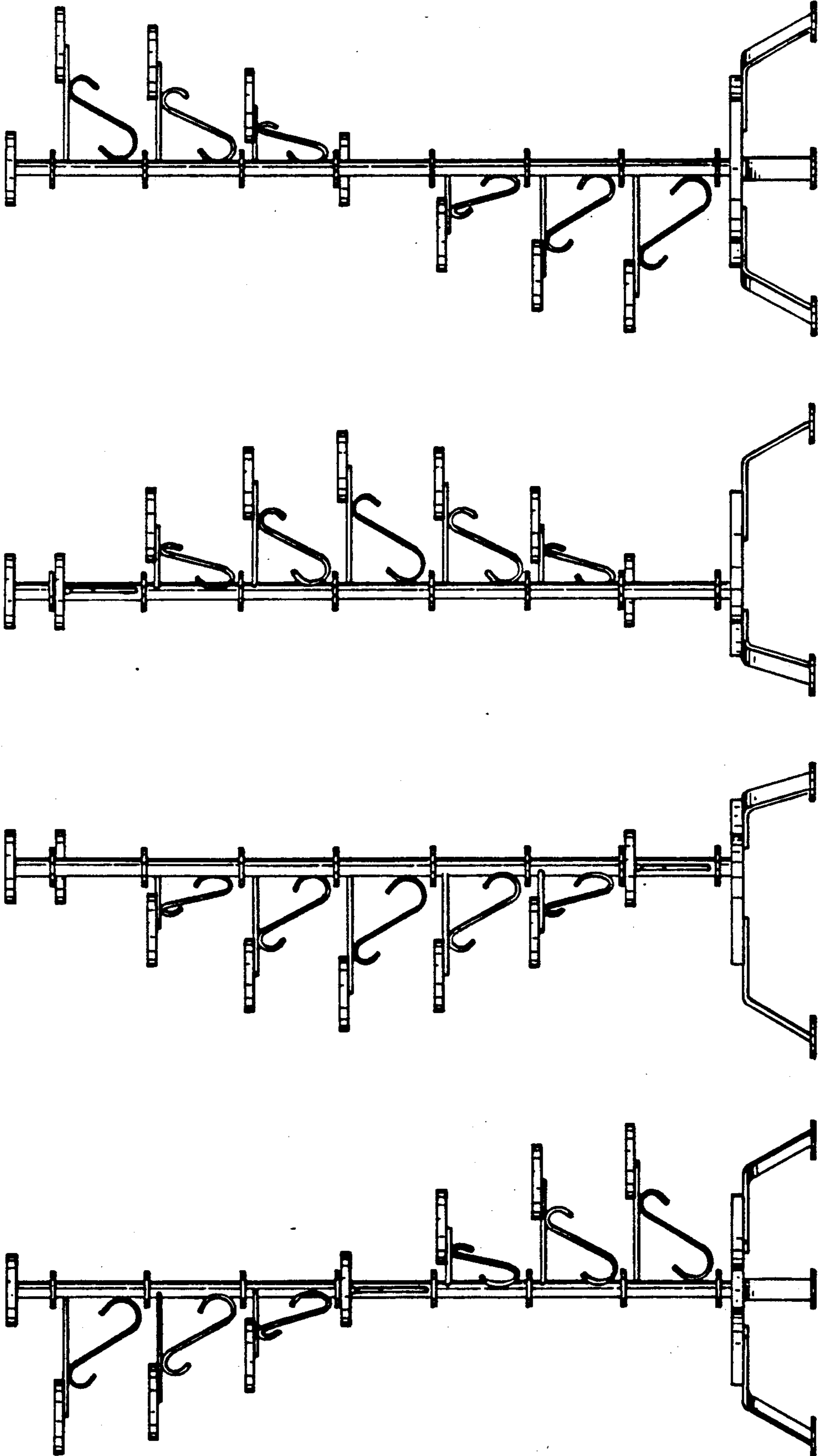

FIG. 4

FIG. 3

FIG. 2

FIG. 1

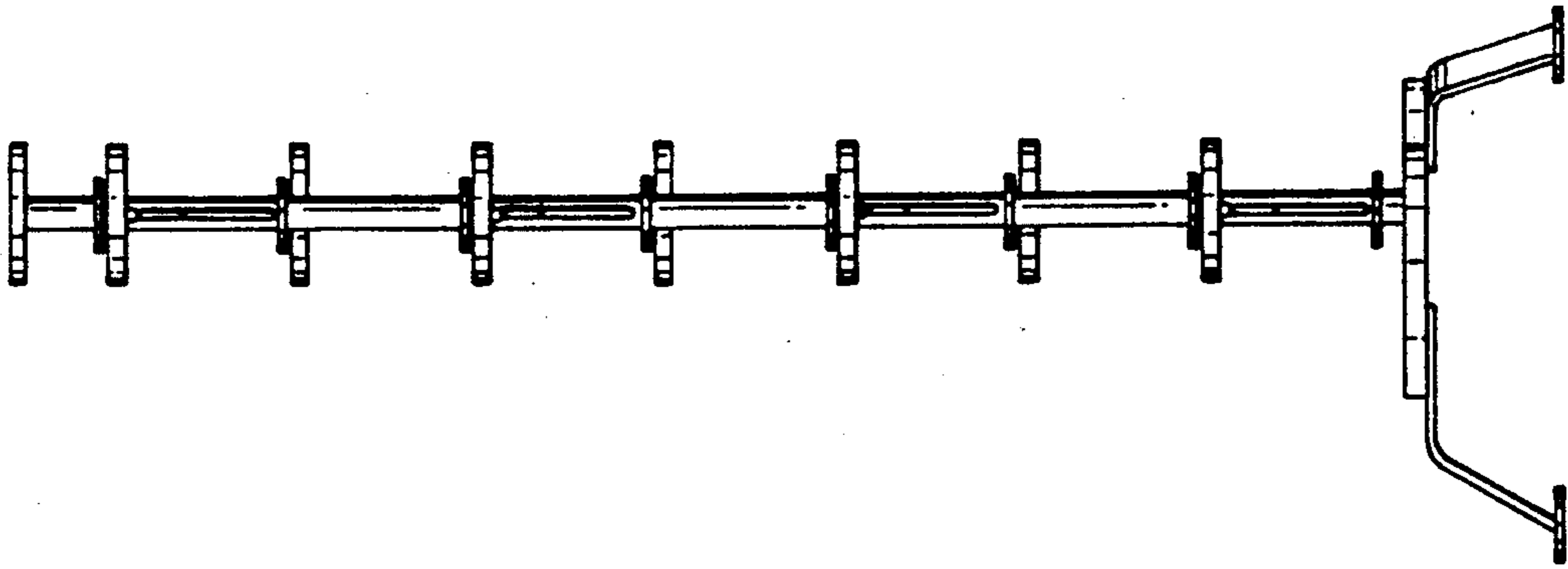

FIG. 8

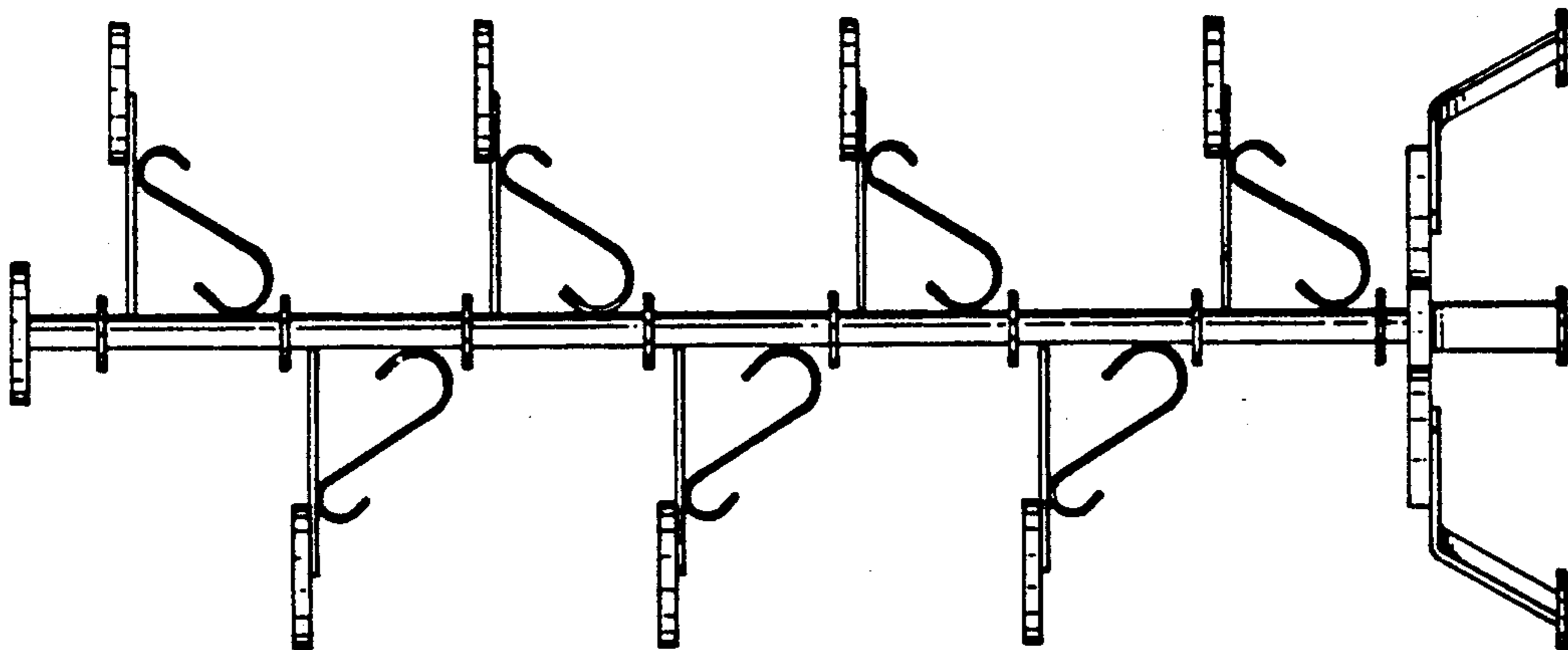

FIG. 7

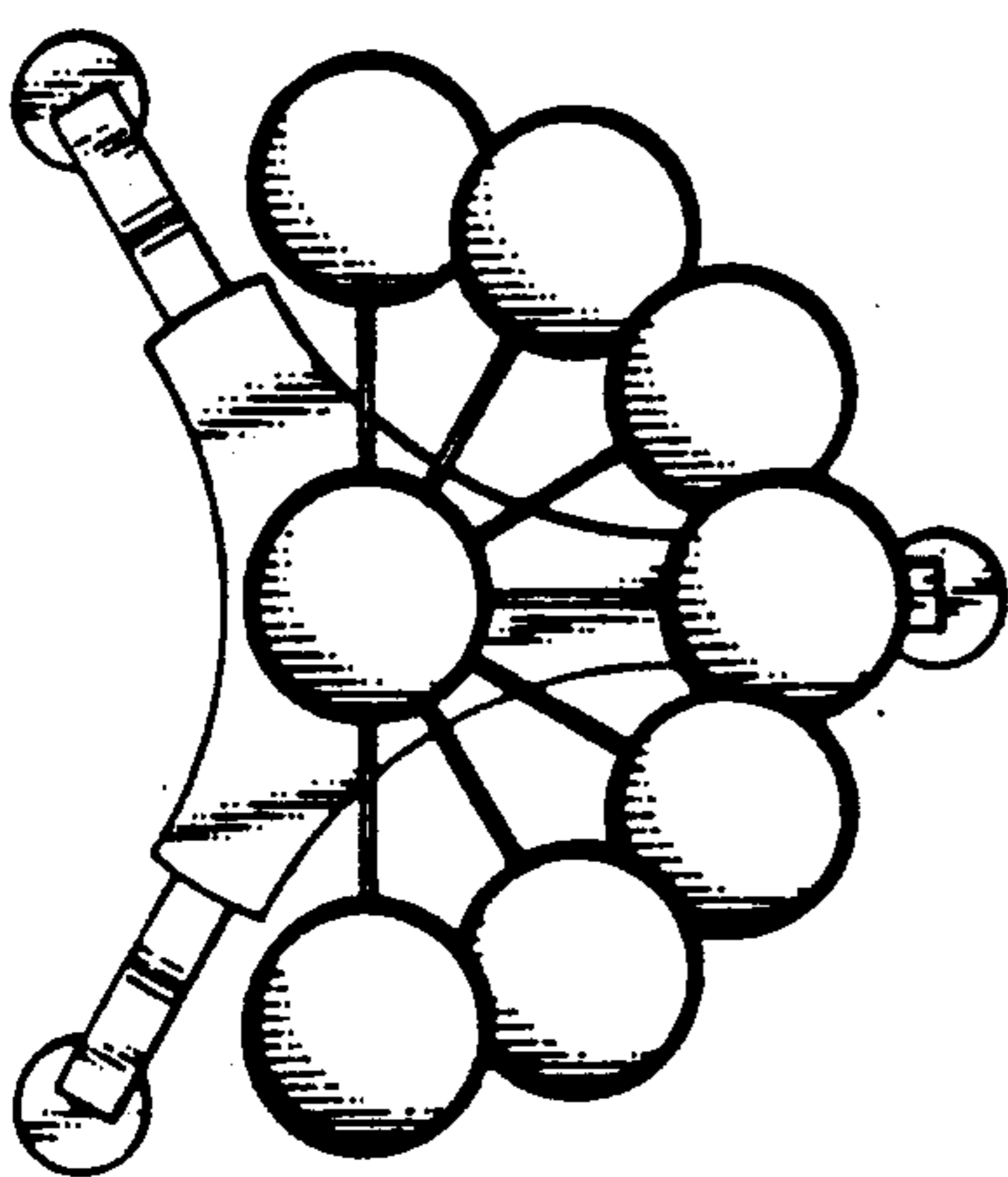

FIG. 5

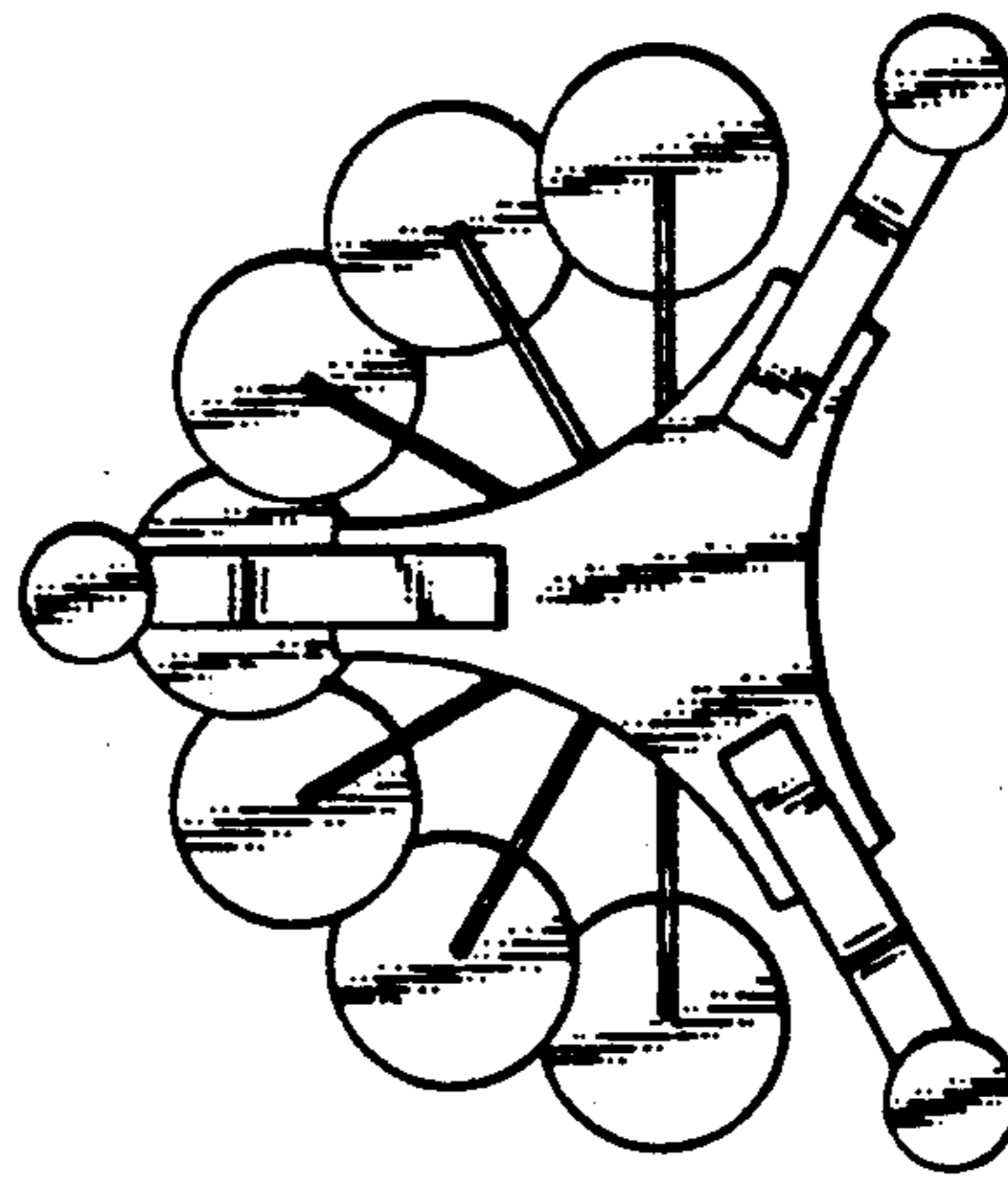

FIG. 6