



US00D331647S

# United States Patent [19] Embree

[11] Patent Number: **Des. 331,647**  
[45] Date of Patent: **\*\* Dec. 8, 1992**

[54] **HUMMINGBIRD FEEDER**

[75] Inventor: **Donald Embree, Uniontown, Ohio**  
[73] Assignee: **Rubbermaid Incorporated, Wooster, Ohio**  
[\*\*] Term: **14 Years**  
[21] Appl. No.: **497,635**  
[22] Filed: **Mar. 23, 1990**  
[52] U.S. Cl. .... **D30/124**  
[58] Field of Search ..... 119/51.03, 52.2, 57.4, 119/57.8, 57.9, 61, 69.5, 72, 77; D30/121-128, 132-133

**FOREIGN PATENT DOCUMENTS**

2815211 10/1979 Fed. Rep. of Germany ..... 119/72  
3320833 12/1984 Fed. Rep. of Germany ..... 119/57.8  
1047359 12/1953 France ..... 119/77

**OTHER PUBLICATIONS**

Rubbermaid Product Sheet; Jan. 1988; item No. 3420, Hummingbird Feeder.

*Primary Examiner*—A. Hugo Word  
*Assistant Examiner*—Cathy Anne MacCormac  
*Attorney, Agent, or Firm*—Richard B. O'Planick

[57] **CLAIM**

The ornamental design for a hummingbird feeder, as shown and described.

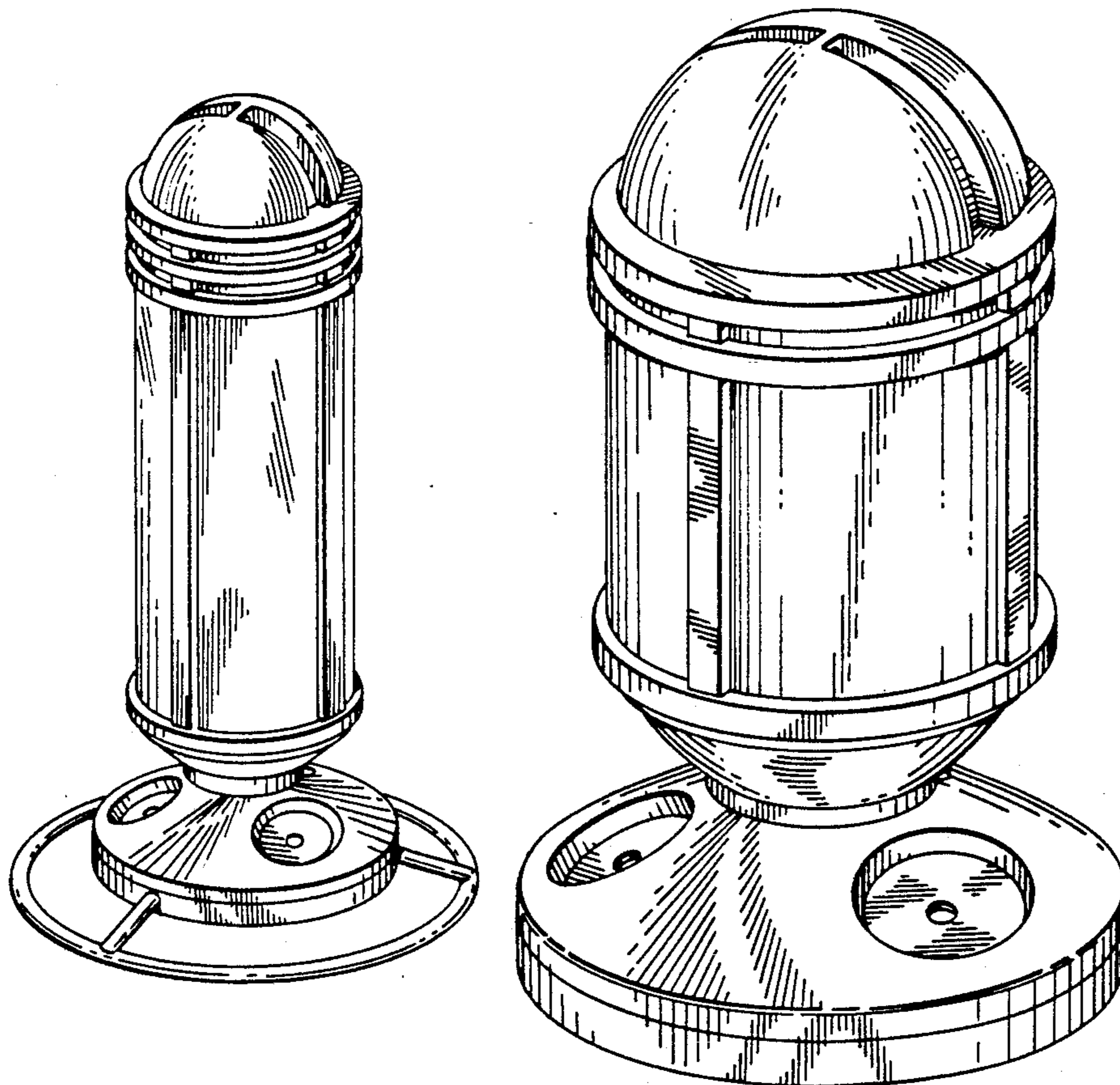
**DESCRIPTION**

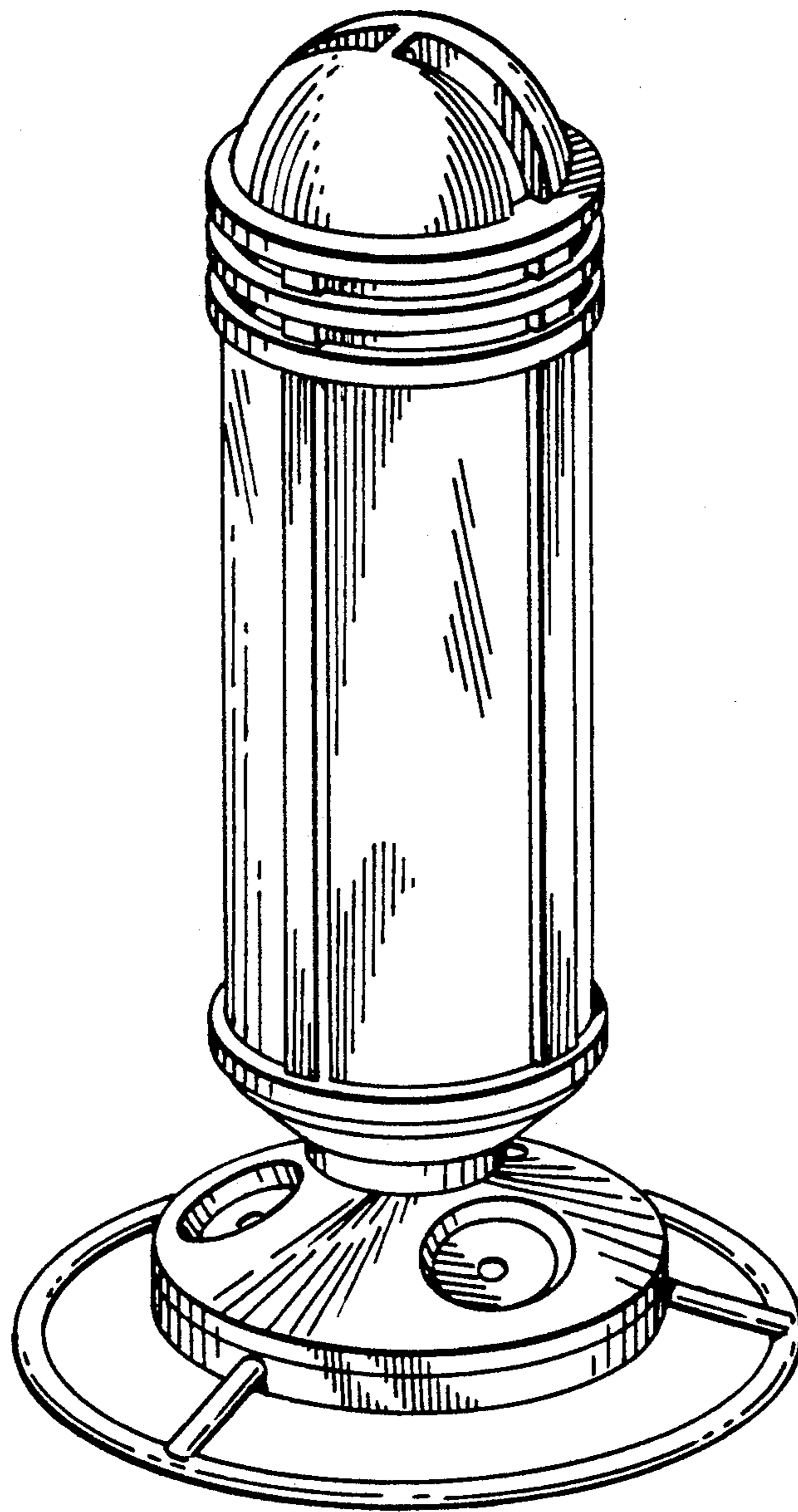
FIG. 1 is a right front perspective view of a hummingbird feeder showing my new design; FIG. 2 is a front elevational view thereof; the rear elevational view being a mirror image; FIG. 3 is a bottom plan view thereof; FIG. 4 is a side elevational view thereof; the opposite side being a mirror image; FIG. 5 is a top plan view thereof; and, FIG. 6 is a right front perspective view of second embodiment of FIG. 1.

[56] **References Cited**

**U.S. PATENT DOCUMENTS**

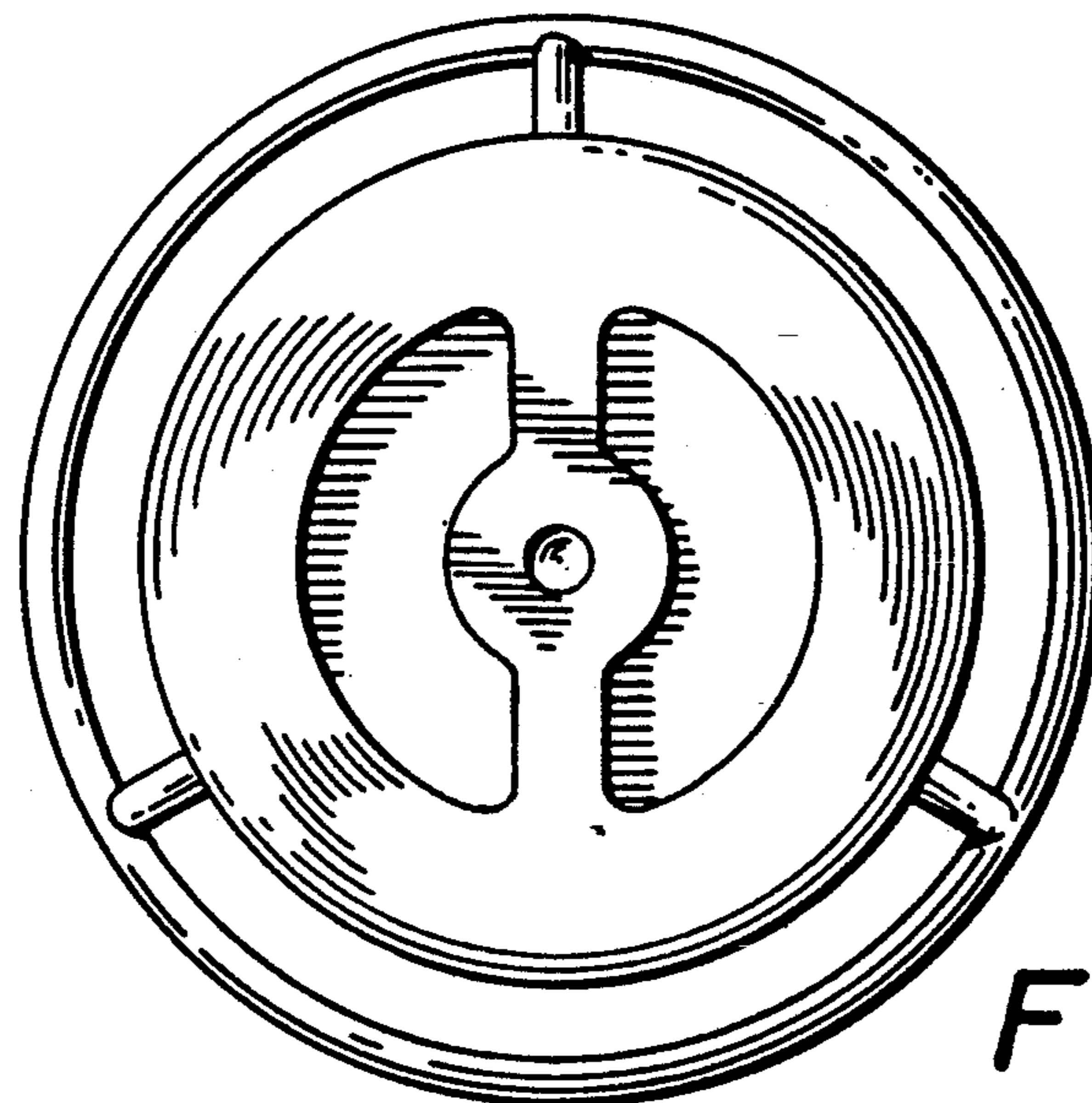
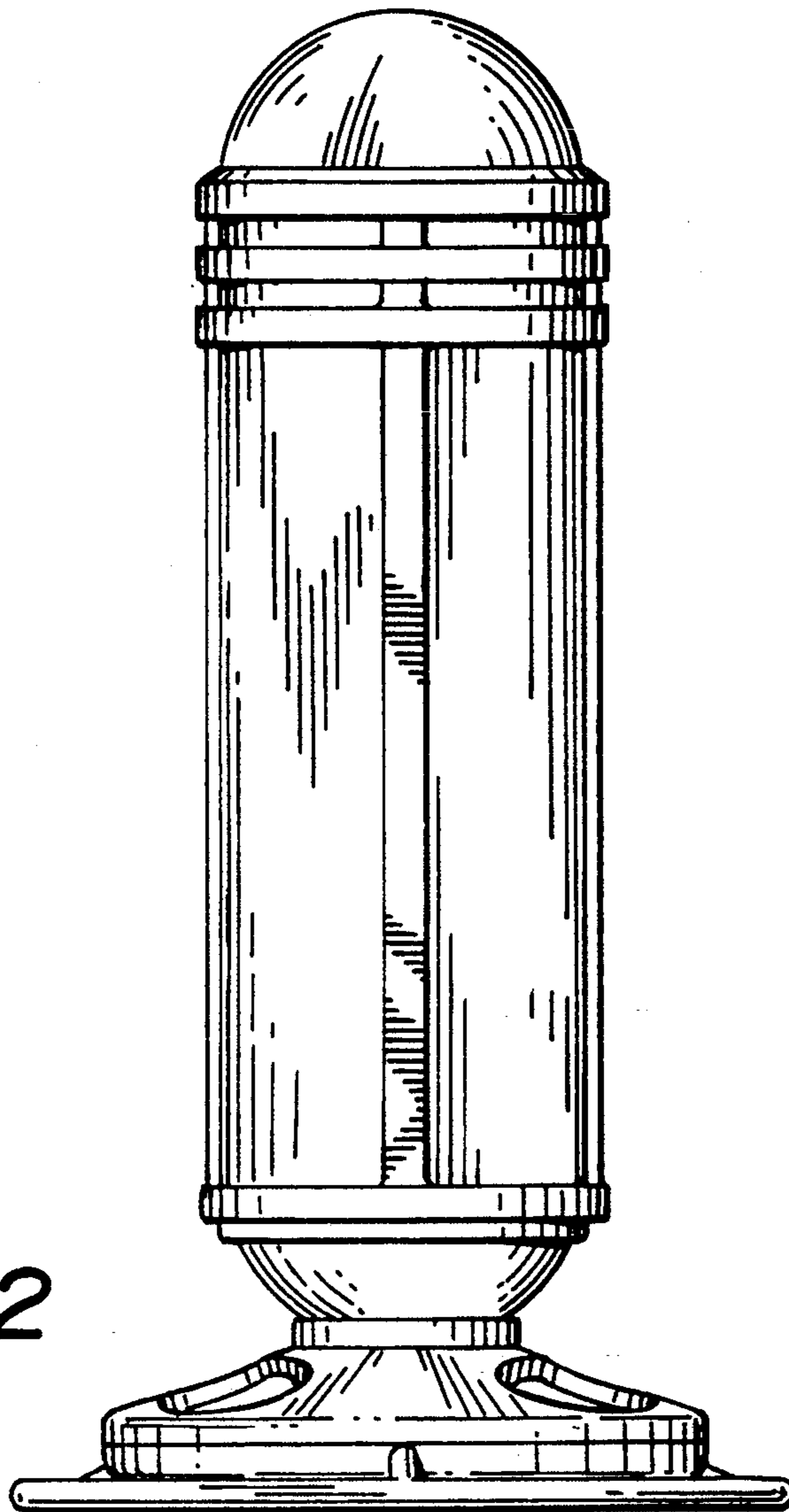
|            |         |             |       |          |
|------------|---------|-------------|-------|----------|
| D. 239,182 | 3/1976  | Kilham      | ..... | D30/125  |
| D. 241,860 | 10/1976 | Calamia     | ..... | D30/128  |
| D. 252,288 | 7/1979  | Kilham      | ..... | D30/125  |
| D. 278,614 | 4/1985  | Moss        | ..... | D30/127  |
| D. 300,963 | 5/1989  | Atchley     | ..... | D30/132  |
| 2,696,803  | 12/1954 | Deffenbaugh | ..... | 119/52.2 |
| 3,125,069  | 3/1964  | Fowler      | ..... | 119/77   |
| 4,691,665  | 9/1987  | Hefner      | ..... | 119/77   |
| 4,901,673  | 2/1990  | Overstreet  | ..... | 119/72   |



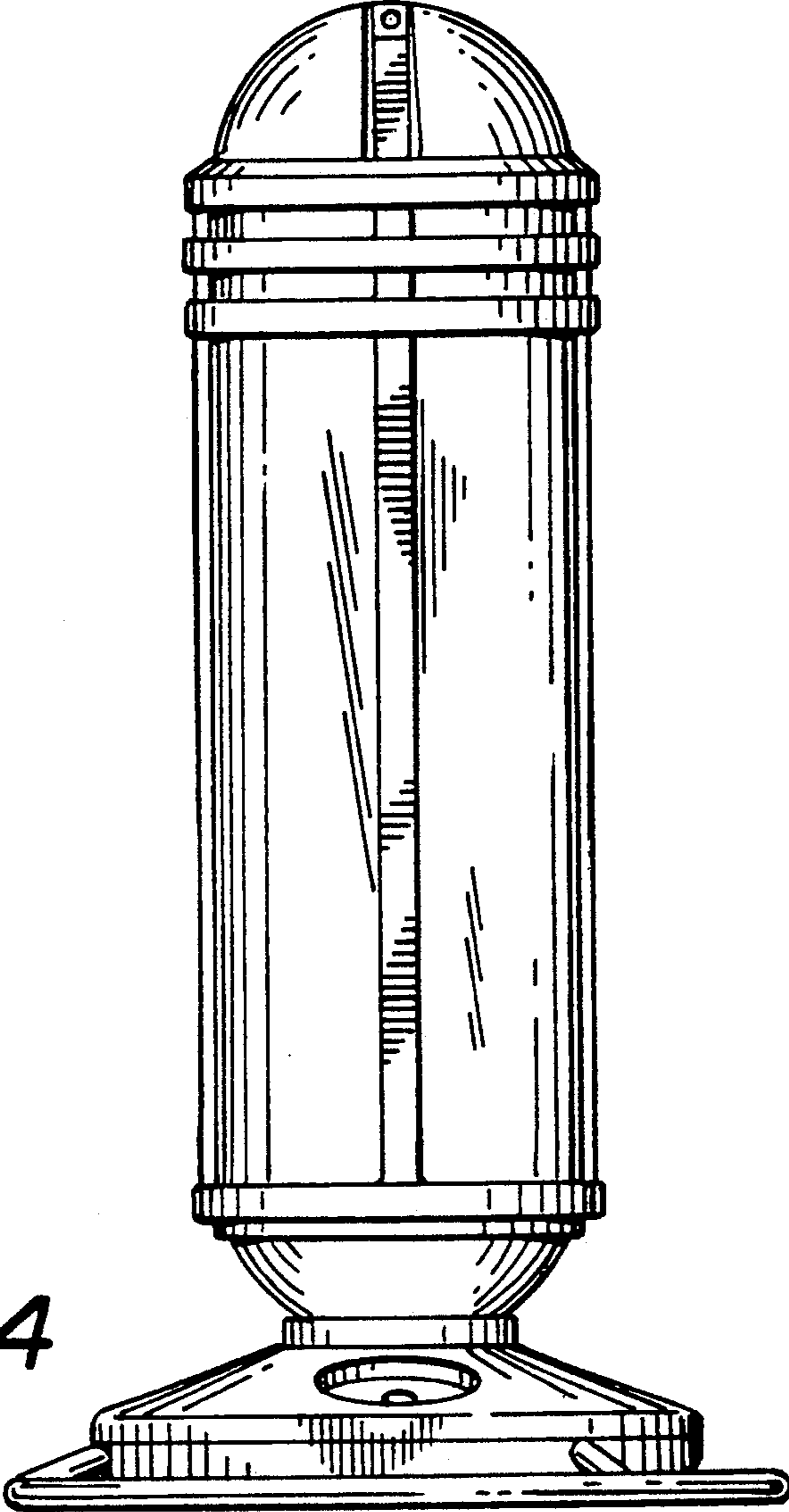


*FIG. 1*

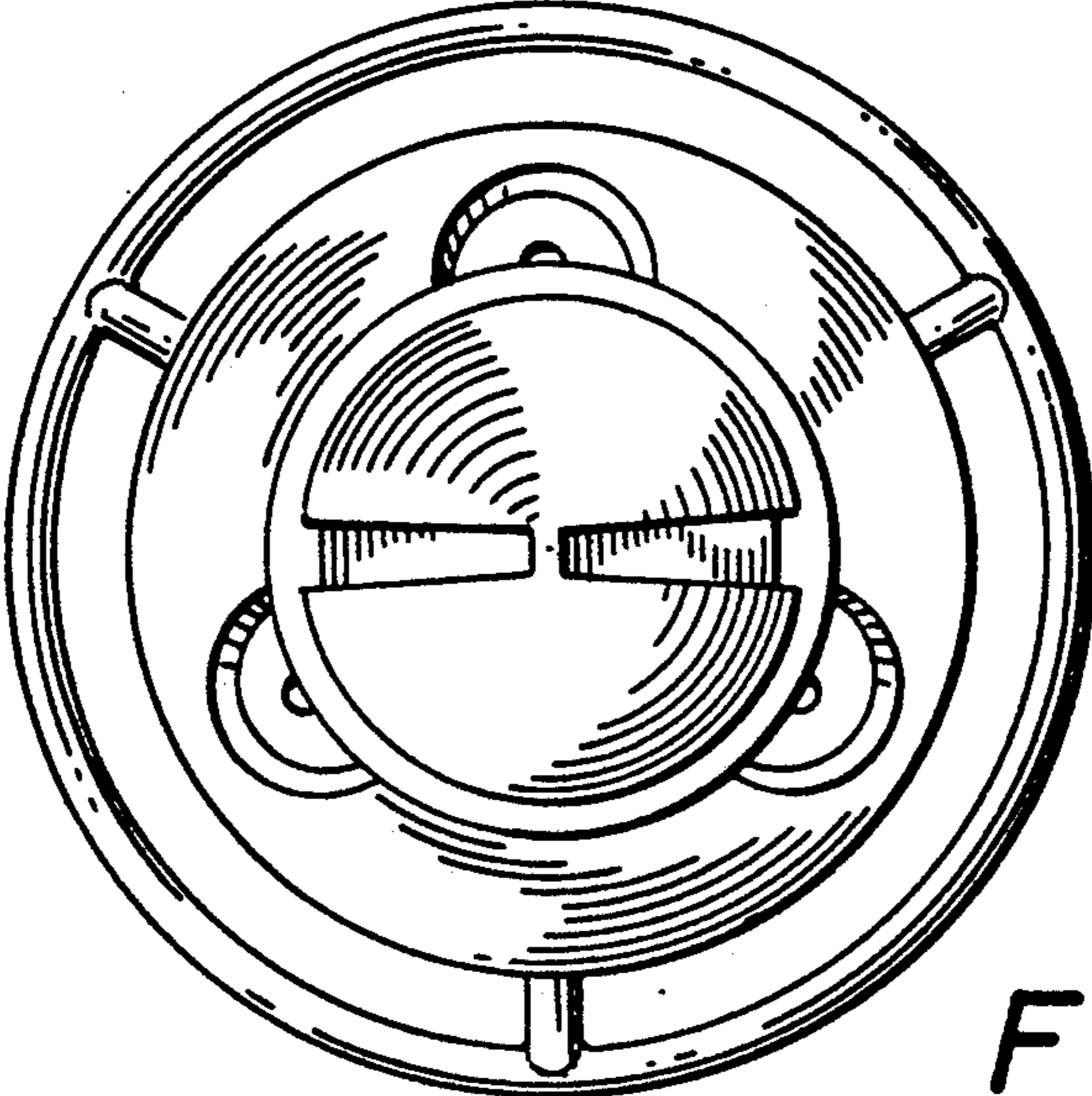
*FIG. 2*



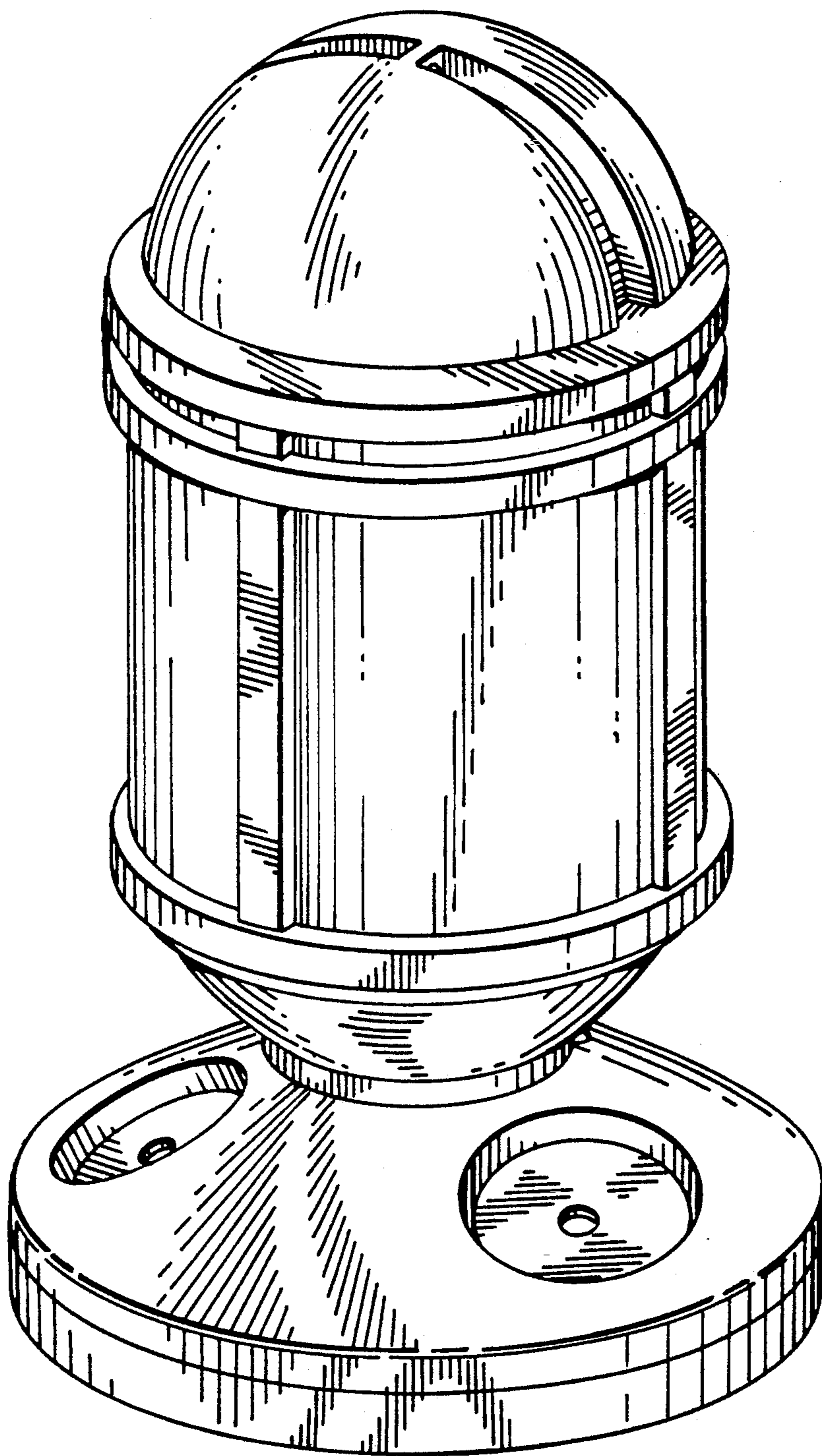
*FIG. 3*



*FIG. 4*



*FIG. 5*



*FIG. 6*