



US00D331548S

# United States Patent [19]

[11] Patent Number: **Des. 331,548**

Cardamone et al.

[45] Date of Patent: **\*\* Dec. 8, 1992**

[54] **EMERGENCY POSITION INDICATING RADIO BEACON**

3,858,166 12/1974 Hammond ..... 441/11  
4,194,246 3/1980 Crist ..... 491/12  
4,981,453 1/1991 Krishan et al. .... D10/107

[75] Inventors: **David P. Cardamone**, Lansdale;  
**Robert L. Muir**, Upland; **Eugene F. Keohane**, Morton; **Robert J. Malloy**, Drexel Hill; **Albert C. Paulovitz**, Kennett Square, all of Pa.

### OTHER PUBLICATIONS

Koden International Corp. 1989 Rescue Beacon.

*Primary Examiner*—Wallace R. Burke

*Assistant Examiner*—Marcus Jackson

*Attorney, Agent, or Firm*—Brian L. Ribando

[73] Assignee: **Litton Systems, Inc.**, Springfield, Pa.

[\*\*] Term: **14 Years**

### [57] CLAIM

[21] Appl. No.: **600,357**

The ornamental design for the emergency position indicating radio beacon, as shown and described.

[22] Filed: **Oct. 19, 1990**

### DESCRIPTION

[52] U.S. Cl. .... **D10/107**

[58] Field of Search ..... D10/104, 106, 107, 120;  
441/1, 2, 6, 7, 8, 10, 11, 12, 13, 16, 17, 18, 19, 20,  
21

FIG. 1 is a left side elevational view of an emergency position indicating radio beacon showing our new design, with the antenna broken away to indicate indeterminate length;

FIG. 2 is a front elevational view thereof;

FIG. 3 is a right side elevational view thereof;

FIG. 4 is a rear elevational view thereof;

FIG. 5 is a top plan view thereof;

FIG. 6 is a bottom plan view thereof; and,

FIG. 7 is a perspective view taken from the top, front, and left side of the emergency position indicating radio beacon.

### [56] References Cited

#### U.S. PATENT DOCUMENTS

D. 294,571	3/1988	Sabin et al. ....	D10/106
D. 319,799	9/1991	Krishan et al. ....	D10/107
498,256	5/1893	Foster .....	441/12
2,397,844	4/1946	Dewhurst .....	D10/107
3,093,107	6/1963	Grand et al. ....	441/12
3,299,398	1/1967	Hersey et al. ....	441/12

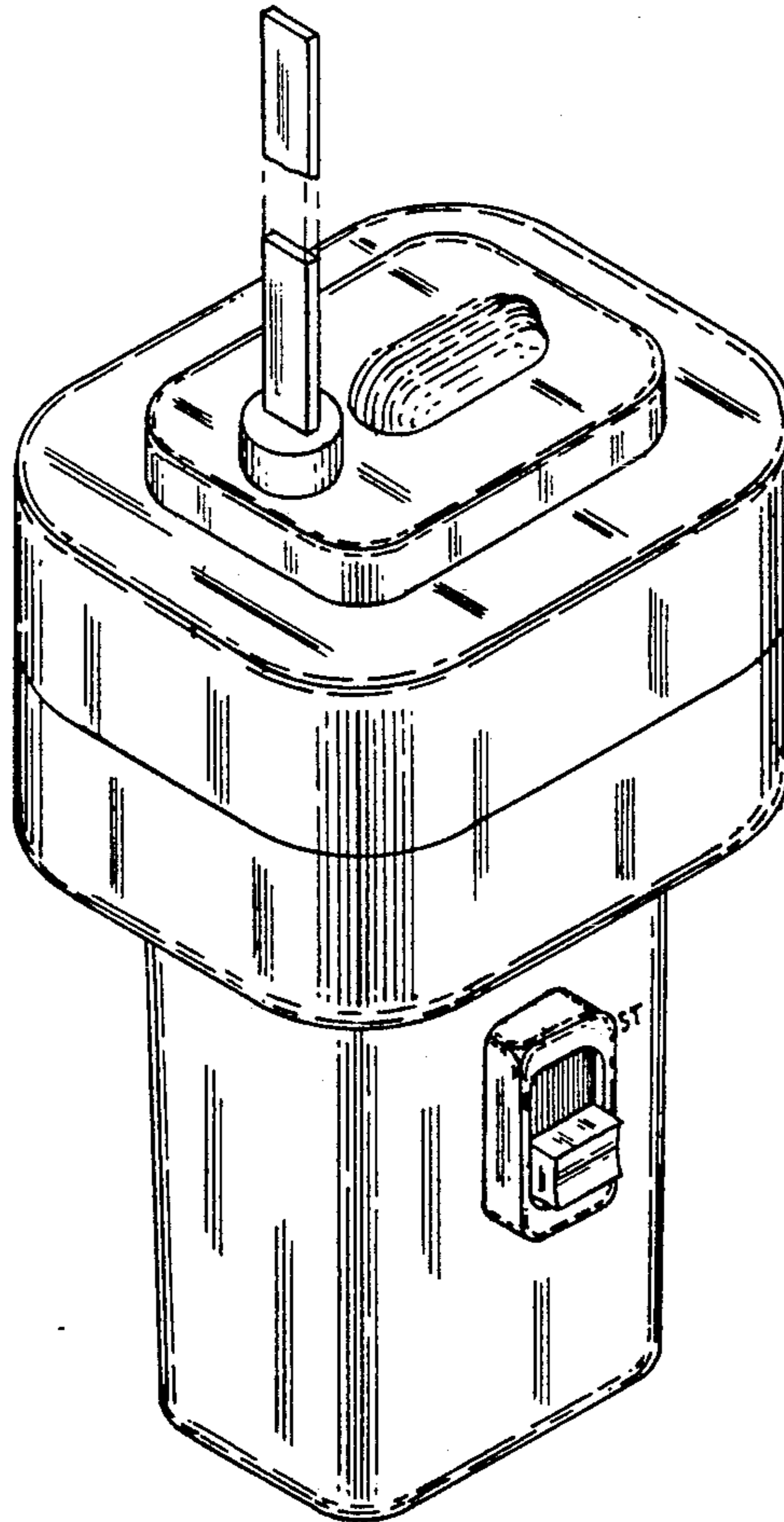

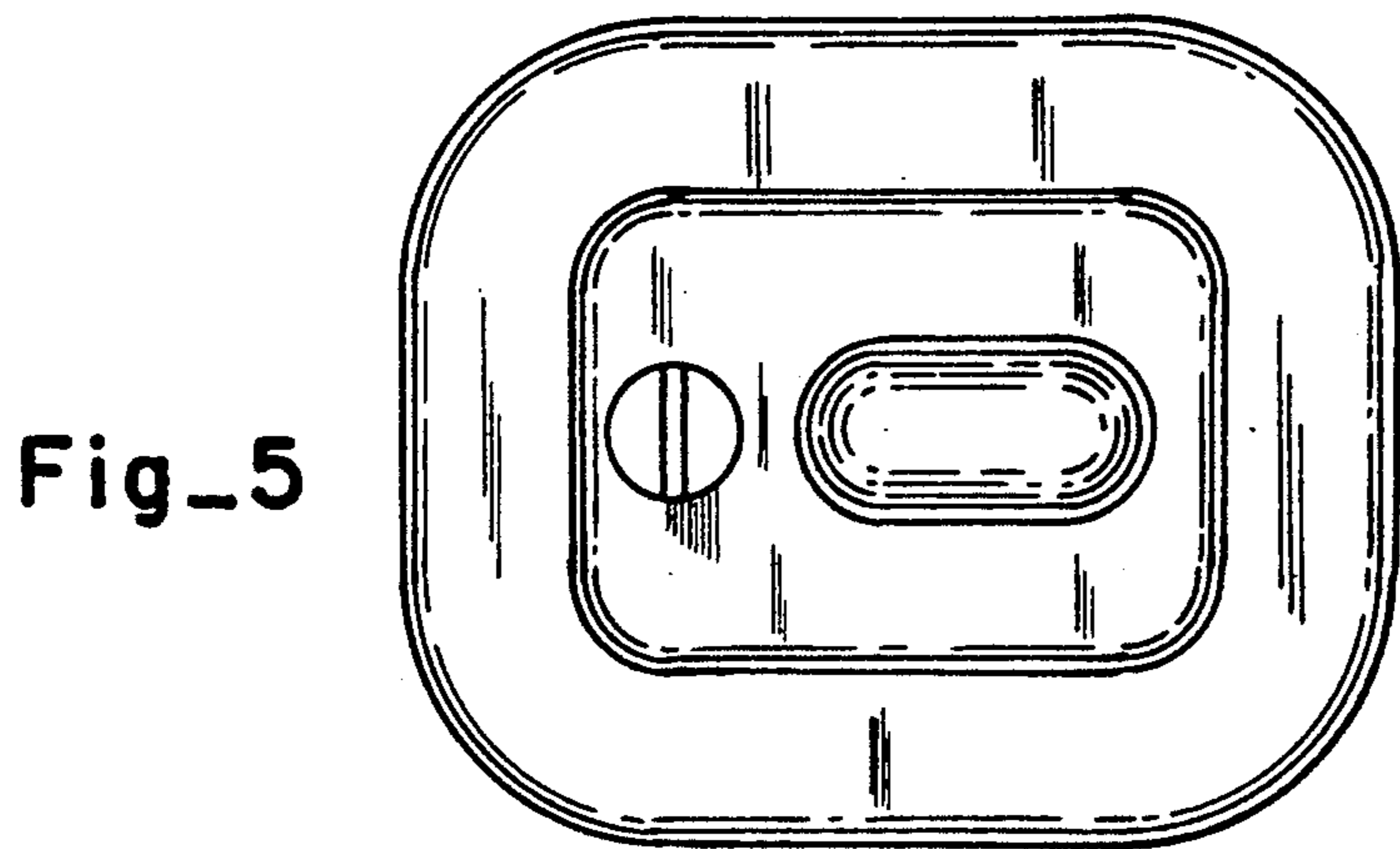
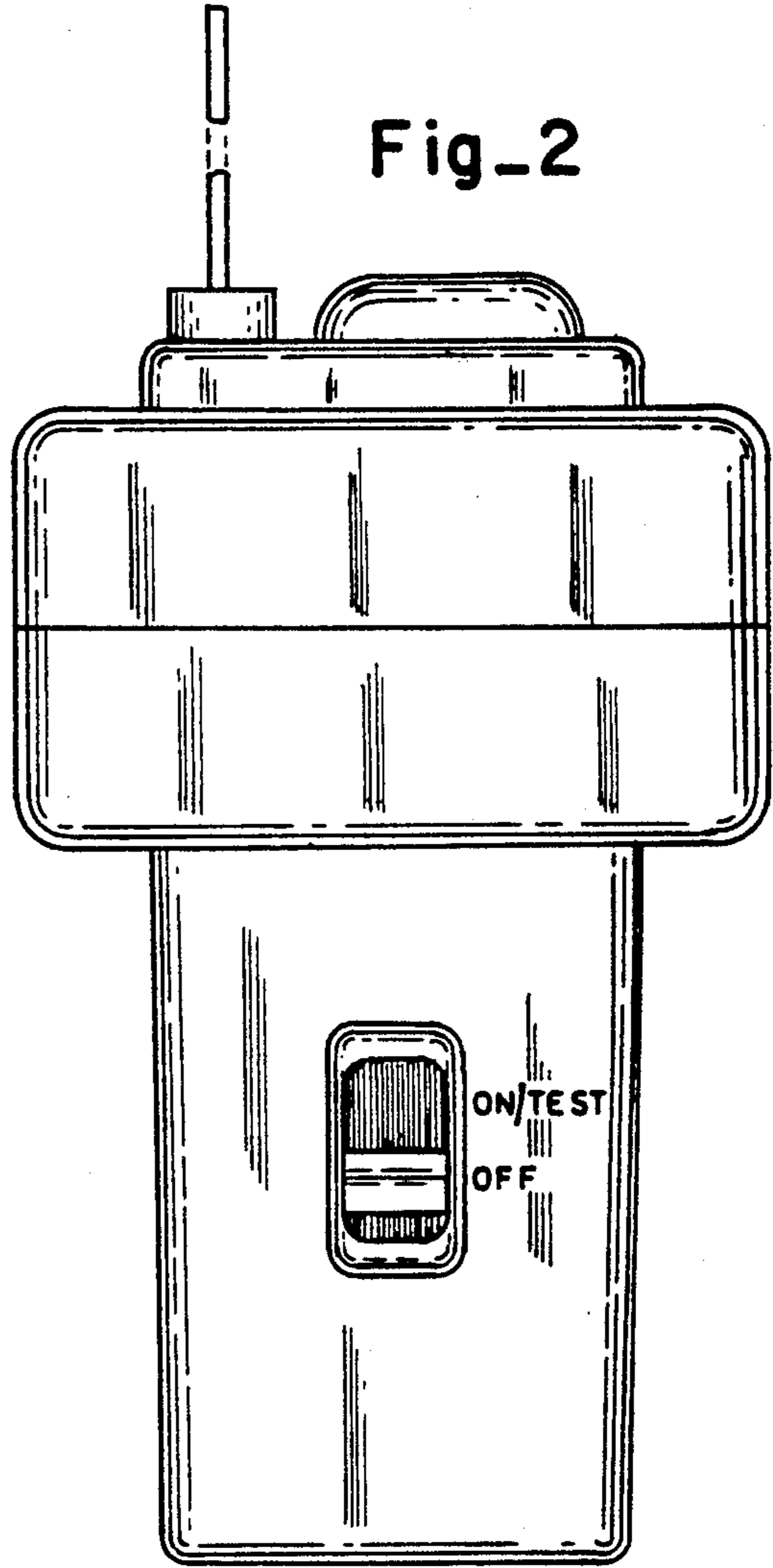
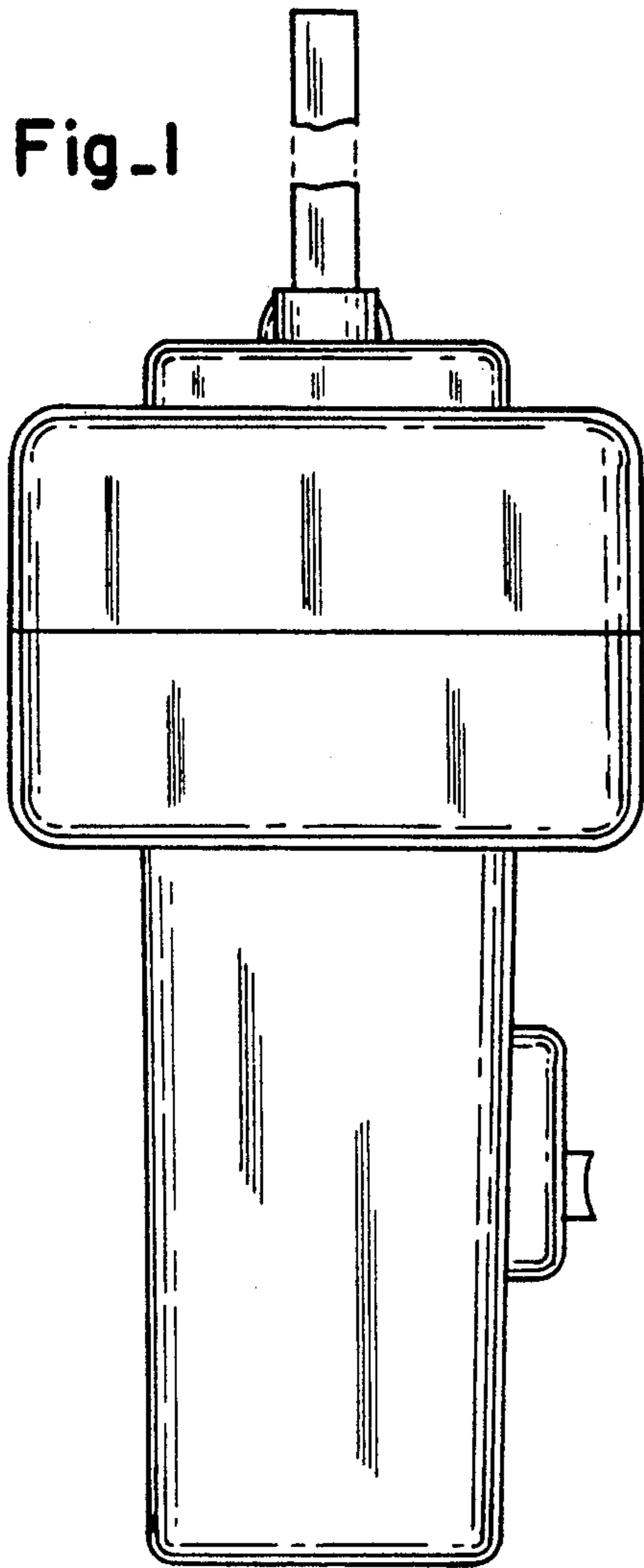

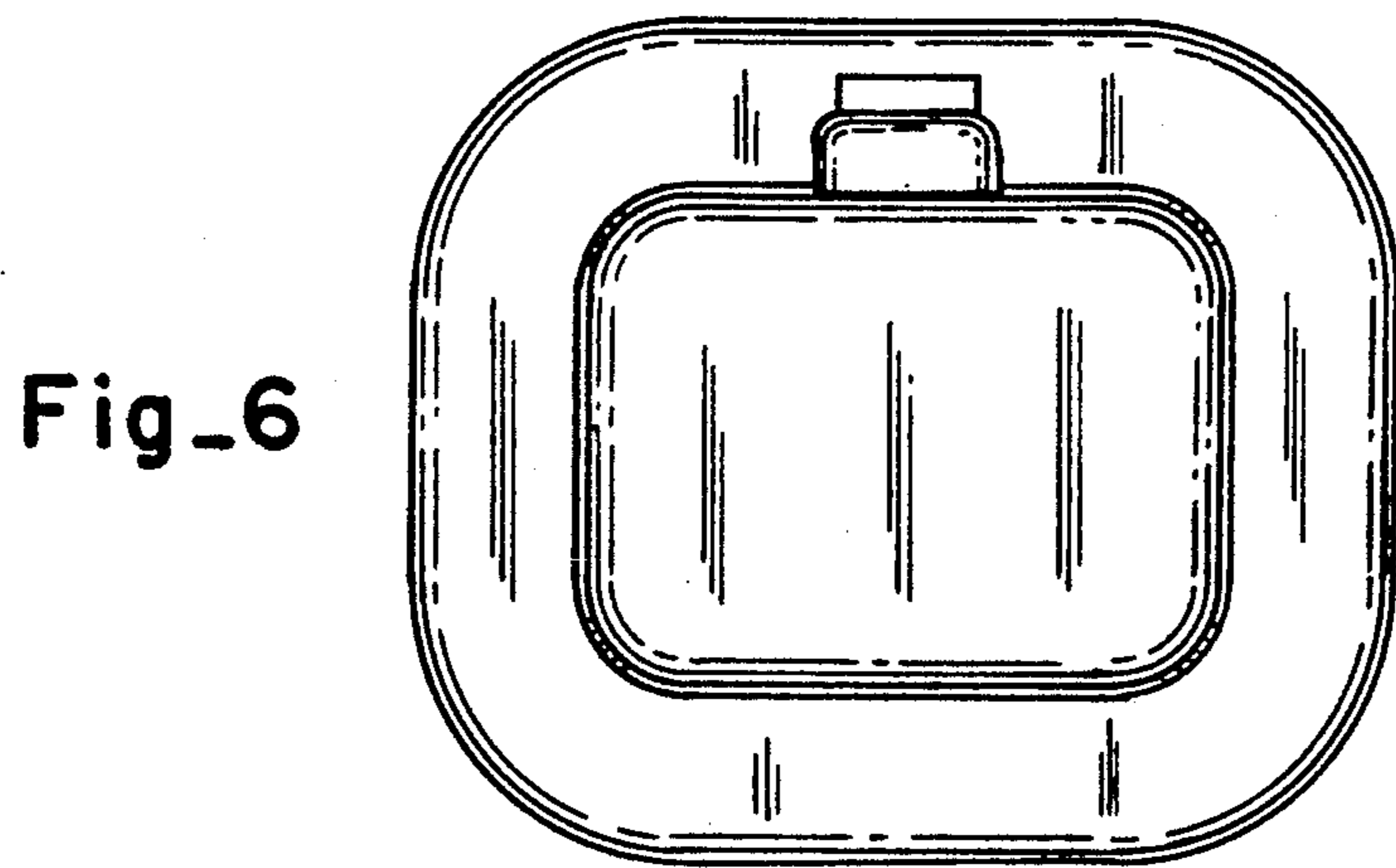
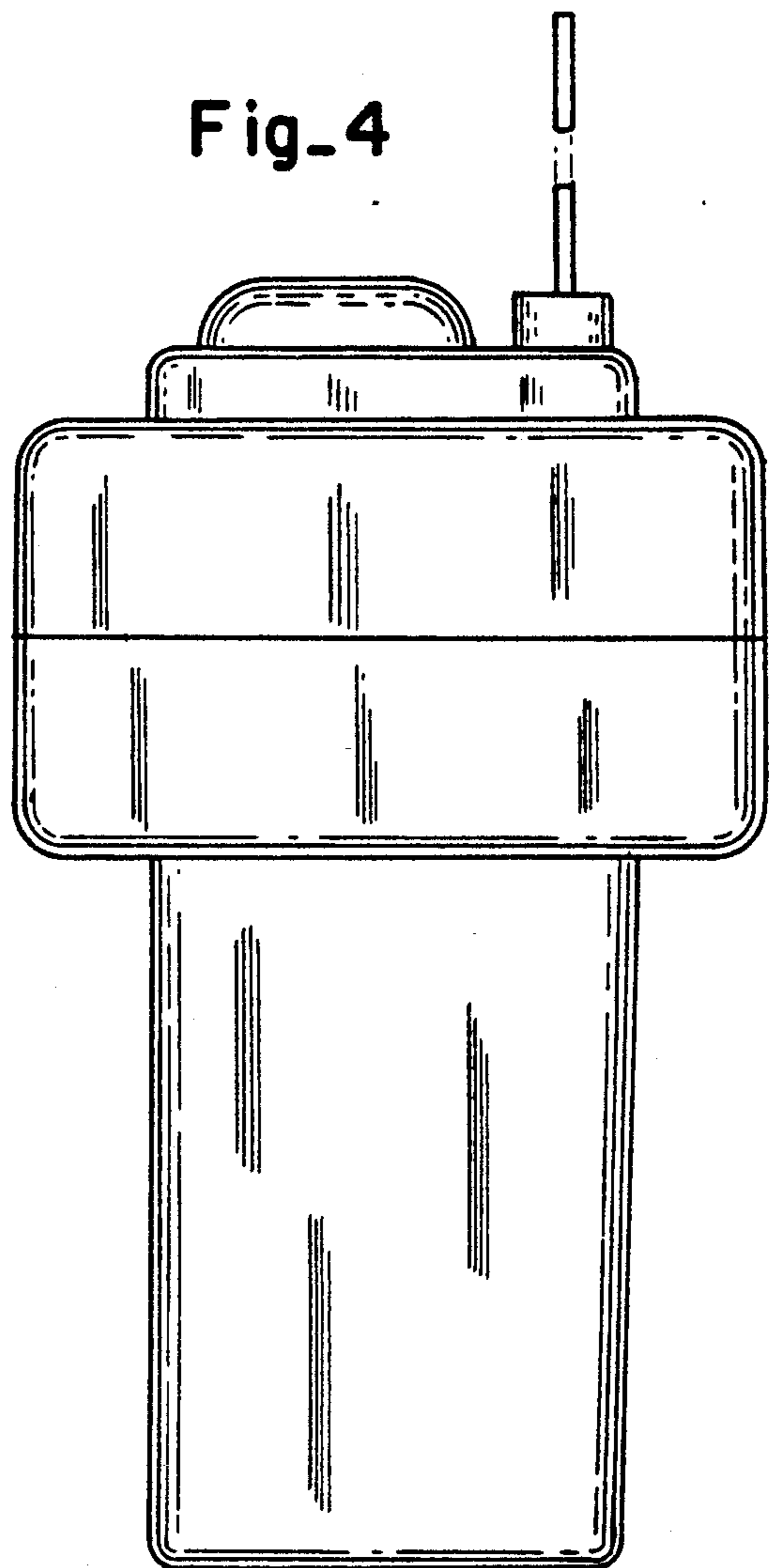
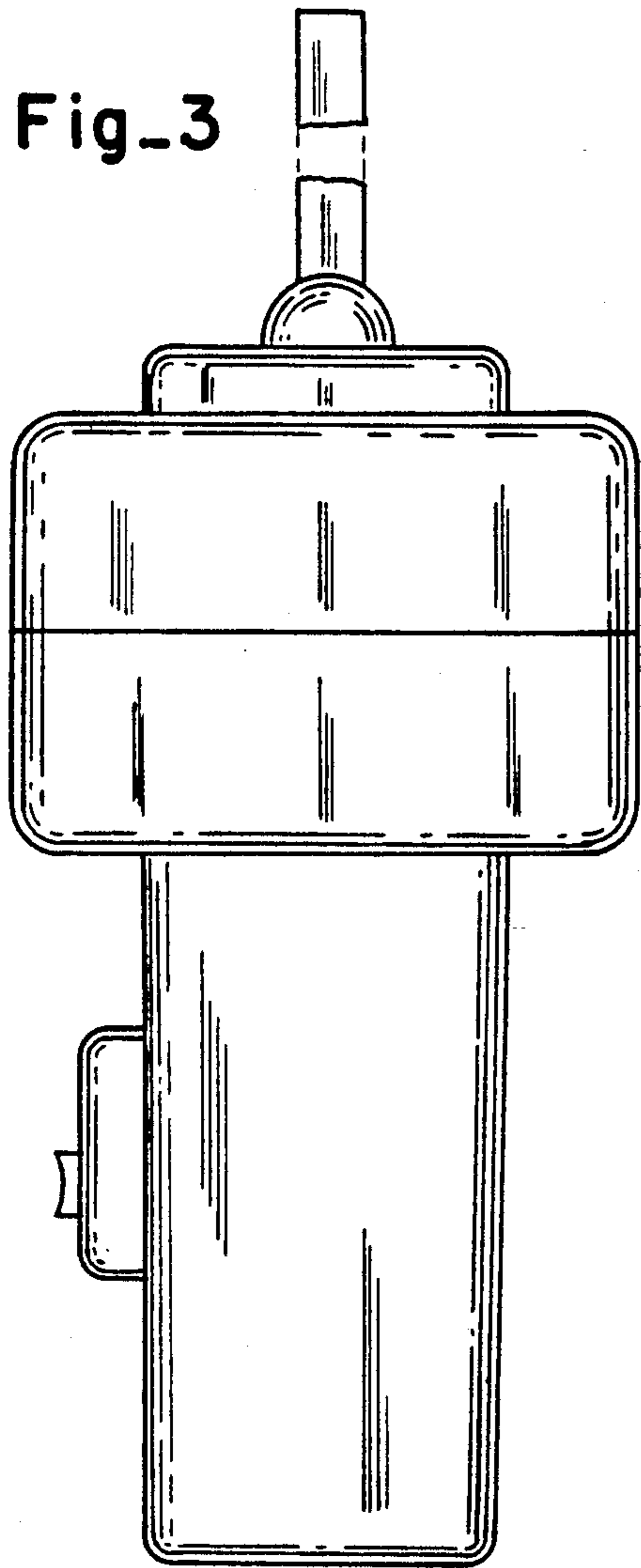



Fig. 7

