



US00D331495S

United States Patent [19]

[11] Patent Number: **Des. 331,495**

Heetman

[45] Date of Patent: **** Dec. 8, 1992**

[54] UMBRELLA HANDLE

[76] Inventor: **Joost Heetman**, Nieuwe Leliestraat
34 III, 1015 ST Amsterdam,
Netherlands

[**] Term: **14 Years**

[21] Appl. No.: **547,444**

[22] Filed: **Jul. 3, 1990**

[30] Foreign Application Priority Data

Jan. 4, 1990 [IB] Int'l Pat. Institute 65086-00

[52] U.S. Cl. D3/14

[58] Field of Search D3/1-17;
D26/37, 38; 362/102; 135/15.1, 16-19.5, 20.1,
20.3, 22-24, 25.1, 25.4, 25.41, 65, 66

[56] References Cited

U.S. PATENT DOCUMENTS

D. 126,990 5/1941 Roberts D3/1
2,185,466 1/1940 Jostes 135/22

FOREIGN PATENT DOCUMENTS

226067 12/1924 United Kingdom 135/65

Primary Examiner—Louis S. Zarfes

Attorney, Agent, or Firm—Christie, Parker & Hale

[57] CLAIM

The ornamental design for umbrella handle, as shown and described.

DESCRIPTION

FIG. 1 is a perspective view of an umbrella handle showing my new design.

FIG. 2 is an enlarged bottom plan view of the umbrella handle;

FIG. 3 is an enlarged side elevation view thereof in the direction of 3—3 in FIG. 2. The elevation view of the handle in FIG. 3 in the direction of each pedal is identical;

FIG. 4 is an enlarged side elevation view thereof in the direction of 4—4 in FIG. 2. The elevation of the handle in FIG. 4 at the other two junctions between the pedals is identical;

FIG. 5 is an enlarged top end view thereof;

FIG. 6 is an enlarged longitudinal cross-sectional view thereof taken along the lines 5—5 of FIG. 2; and,

FIG. 7 is an even further enlarged partial view of the bottom thereof taken at 7—7 of FIG. 2.

The broken line showing of an umbrella in FIG. 1 is for illustrative purposes only and forms no part of the claimed design.

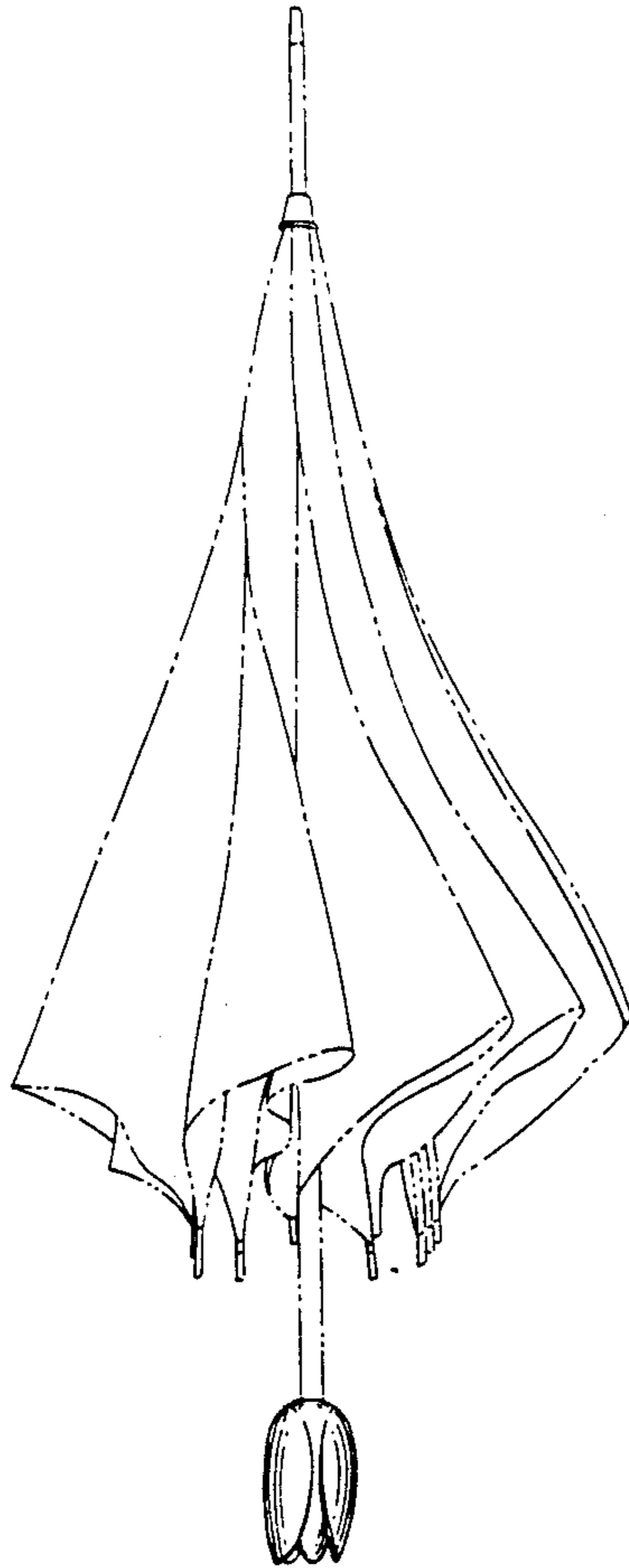

Fig. 1

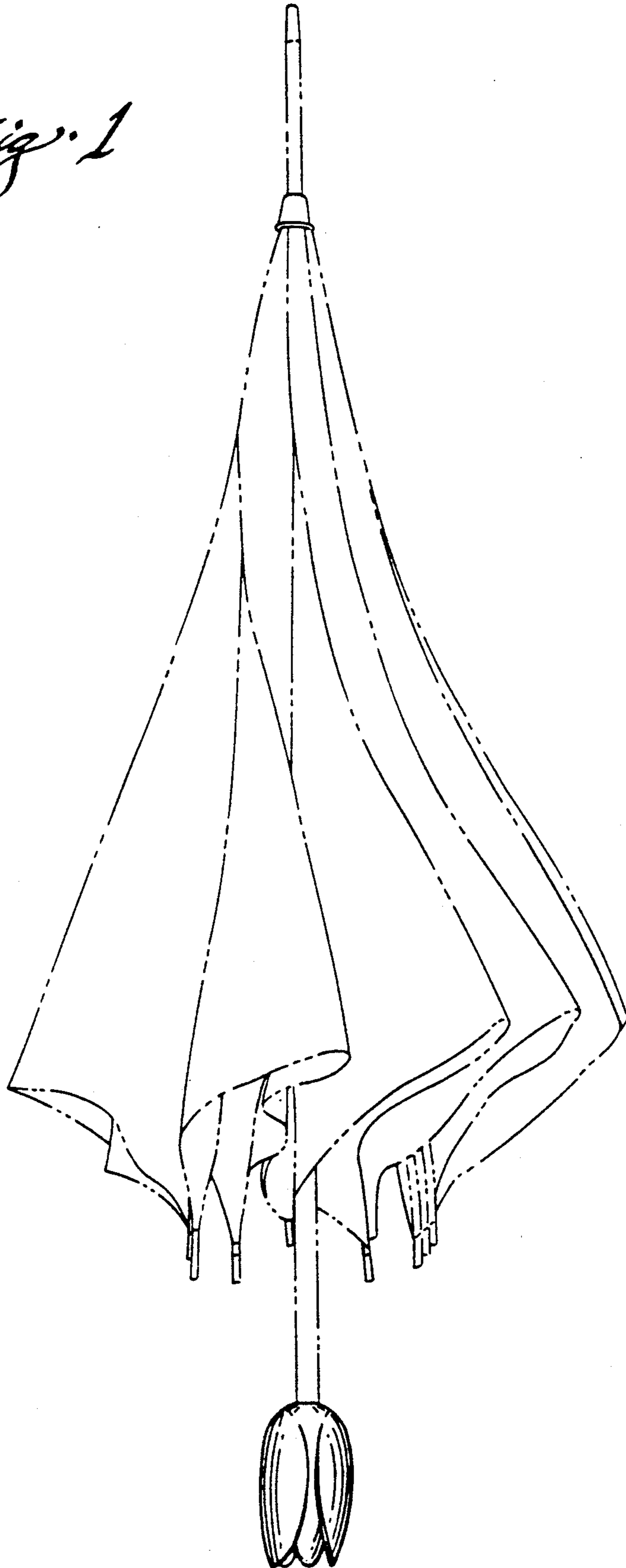

Fig. 2

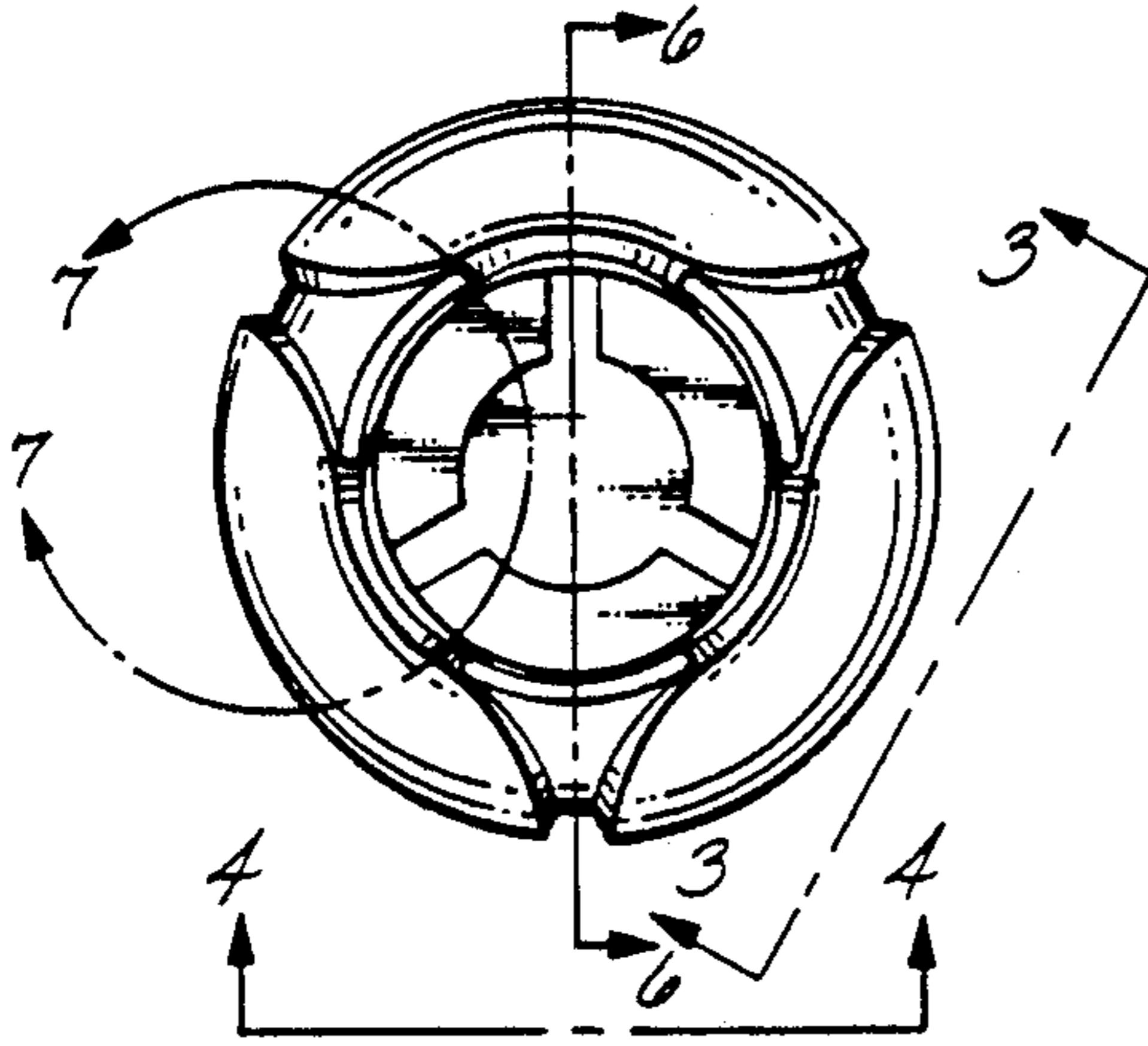

Fig. 5

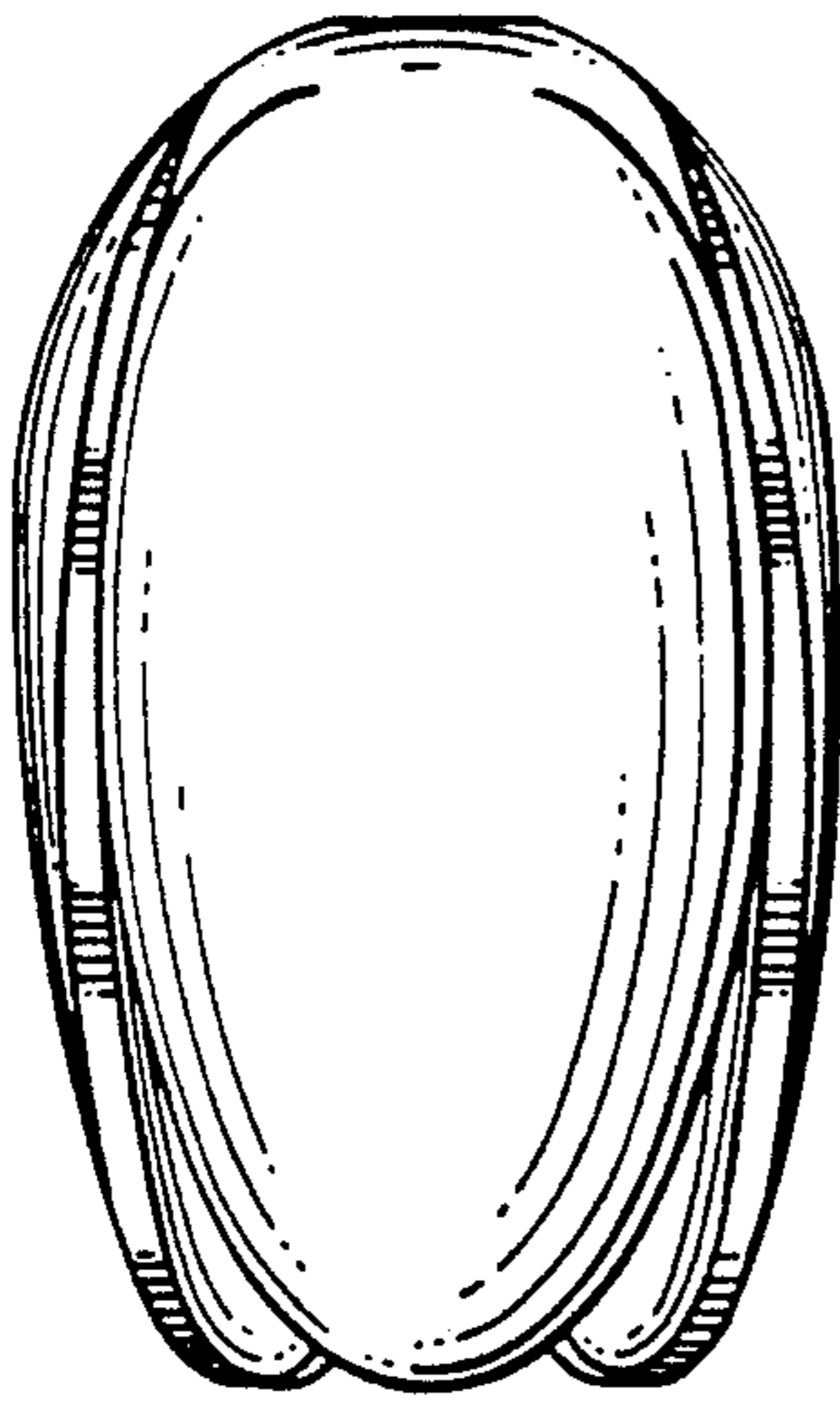
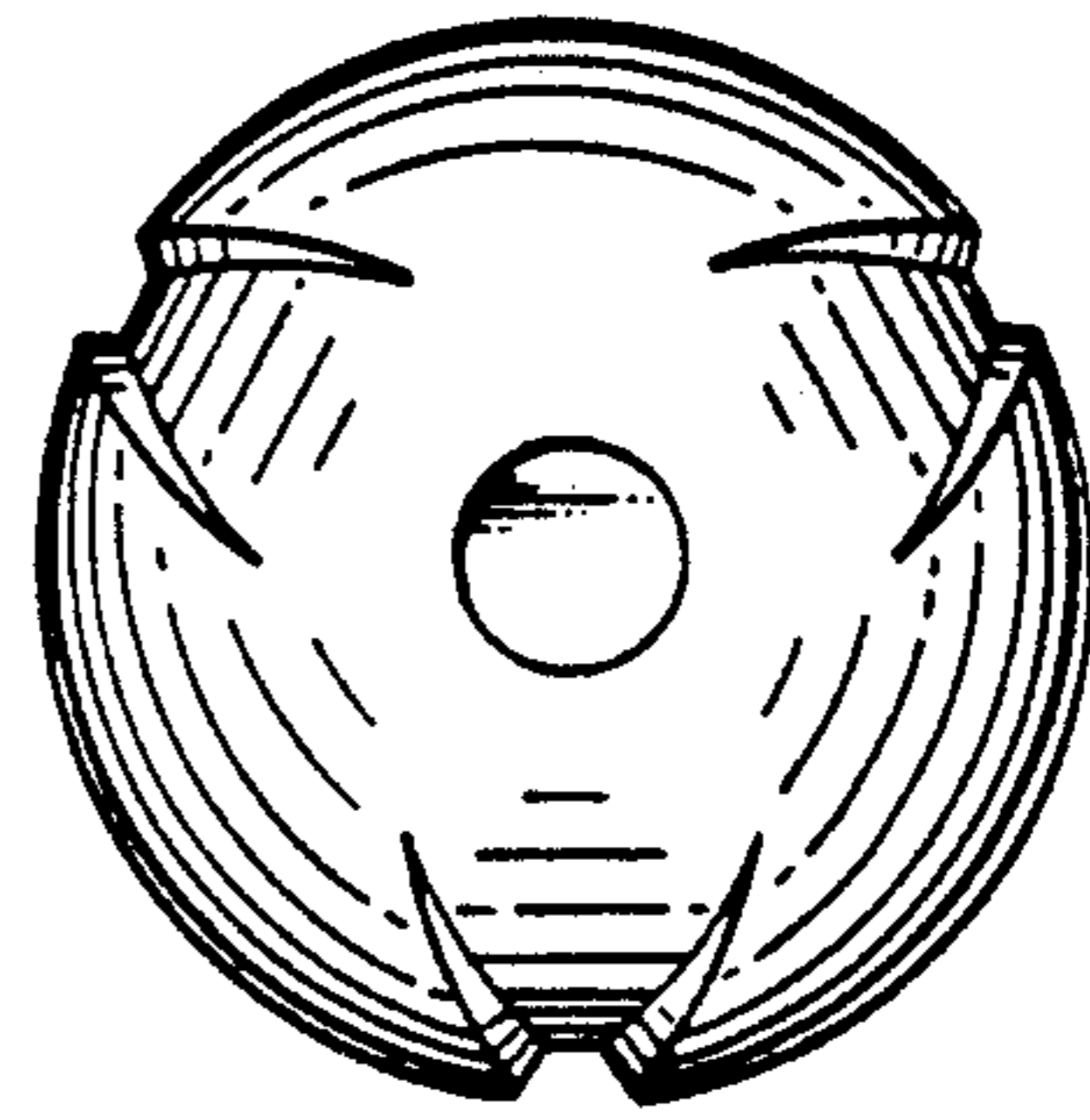

Fig. 3

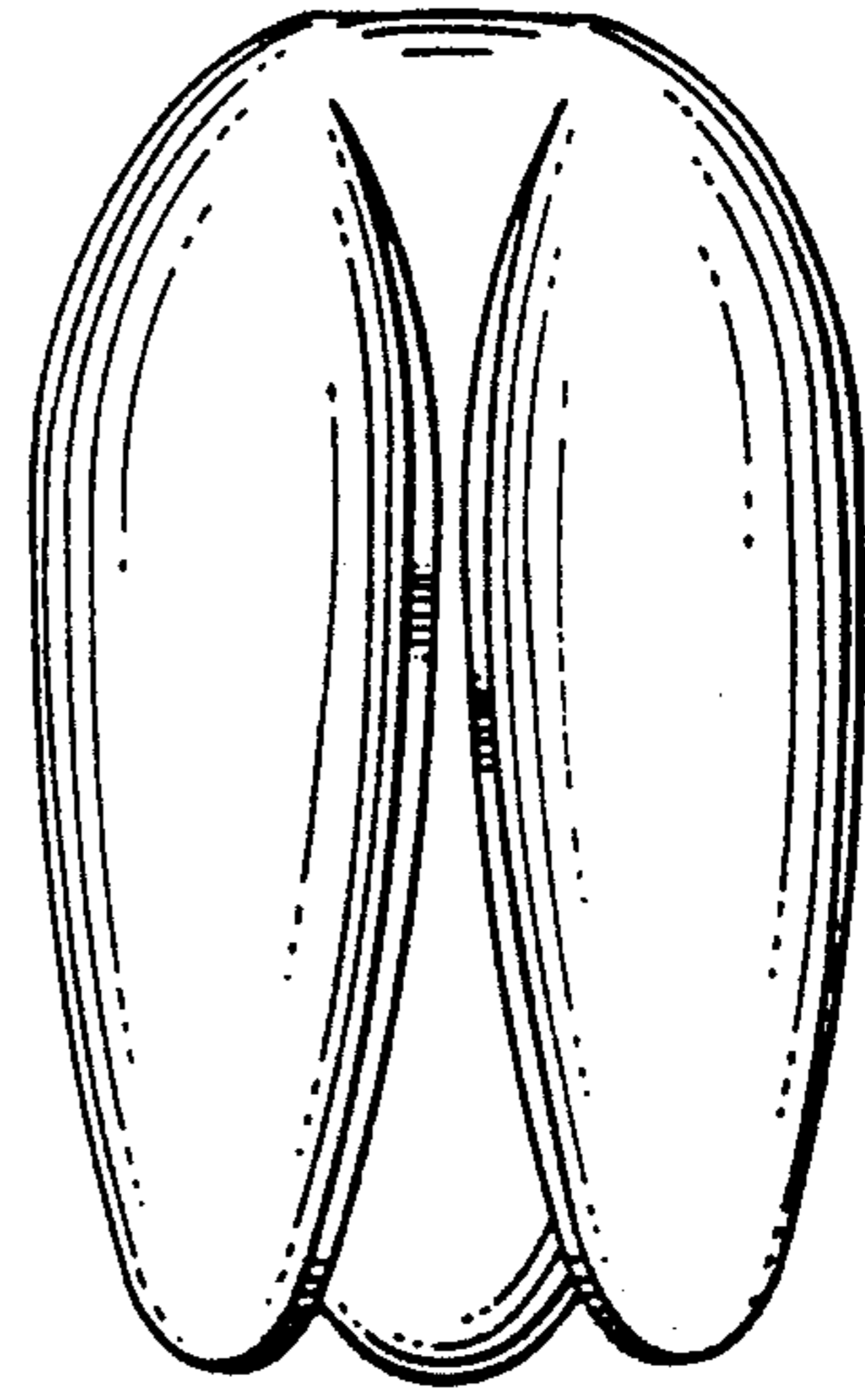

Fig. 4

Fig. 6

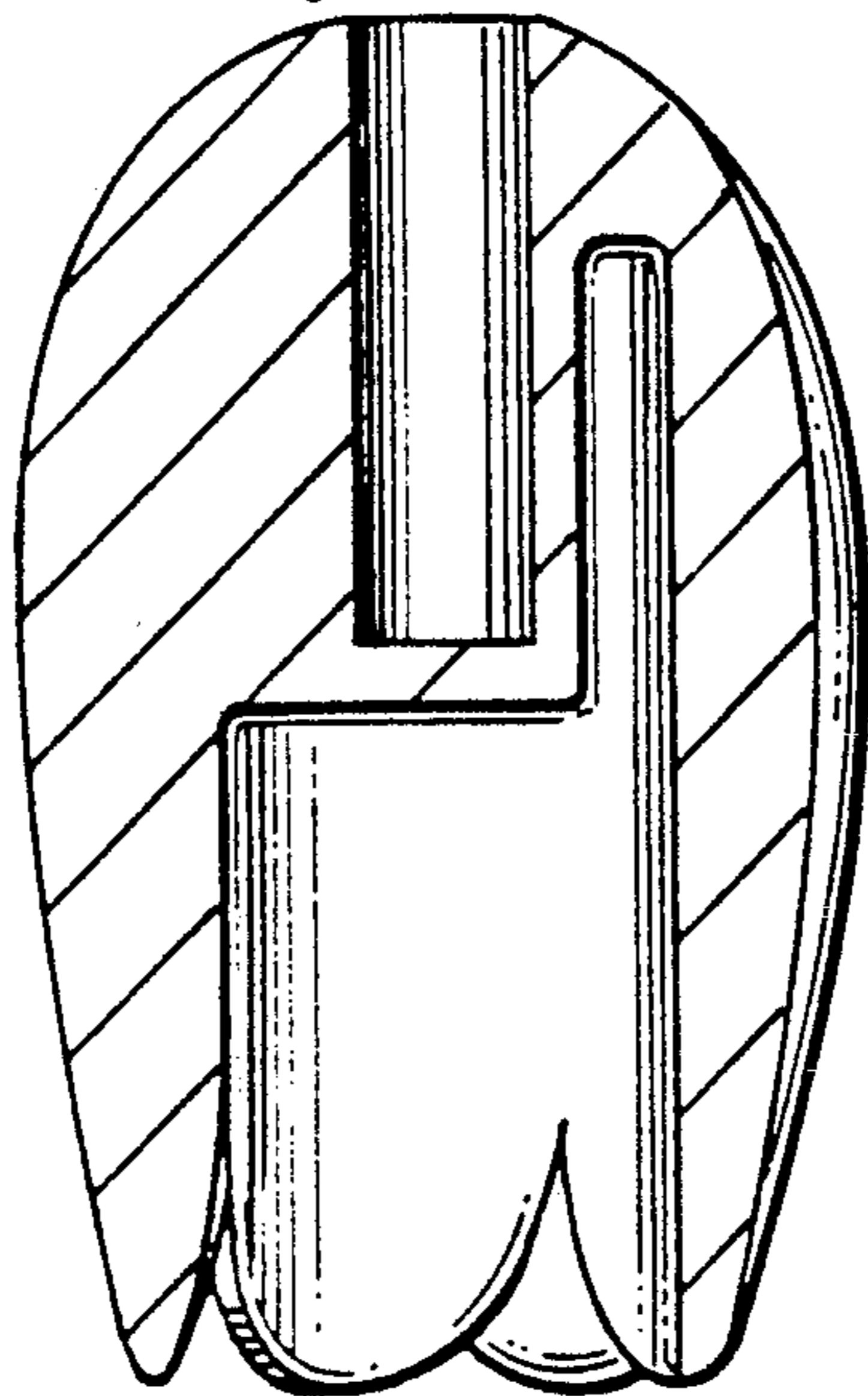

Fig. 7

