



US00D331480S

United States Patent [19]

[11] Patent Number: **Des. 331,480**

Aaserud

[45] Date of Patent: **** Dec. 1, 1992**

[54] WINE CASE

2,530,481 11/1950 Rawn, Jr. 211/74 X
3,333,730 8/1967 Zarlinski 220/117

[76] Inventor: **Marie Aaserud**, Villa Rose Marine
Av. Des Bains, 06600 Antibes,
France

FOREIGN PATENT DOCUMENTS

2104389 8/1972 Fed. Rep. of Germany .
2618522 11/1977 Fed. Rep. of Germany .

[**] Term: **14 Years**

Primary Examiner—Carmen H. Vales-Lado
Assistant Examiner—Jeffrey Asch
Attorney, Agent, or Firm—Foley & Lardner

[21] Appl. No.: **456,681**

[22] Filed: **Dec. 26, 1989**

[30] Foreign Application Priority Data

Jun. 23, 1989 [FR] France 894138

[52] U.S. Cl. **D34/45; D6/476;**
D7/616; D7/619; D34/44

[58] Field of Search **D6/449, 462, 466-469,**
D6/475, 476; D34/40, 42, 44, 45, 46; D7/616,
618, 619; 211/74; 206/203, 503, 510; D3/30.1,
73

[57] CLAIM

The ornamental design for a wine case, as shown and described.

DESCRIPTION

FIG. 1 is a perspective view of a wine case showing my new design, the case having been rotated to its side and the lid having been removed for convenience of illustration;

FIG. 2 is a front perspective view thereof;

FIG. 3 is a top plan view thereof;

FIG. 4 is a front elevational view thereof, the rear view being a mirror image;

FIG. 5 is a right side elevational view thereof, the left side being a mirror image; and,

FIG. 6 is a bottom plan view thereof.

FIGS. 3-6 have been shown on an enlarged scale with respect to FIGS. 1 and 2.

[56] References Cited

U.S. PATENT DOCUMENTS

D. 172,970 9/1954 Jones D34/40
D. 200,488 3/1965 Watson D7/616 X
D. 259,818 7/1981 Beavis D34/45
D. 266,709 10/1982 Box D34/40
D. 268,791 4/1983 Wood D34/45 X
D. 274,573 7/1984 Torokvei D34/45 X
D. 275,142 8/1984 Torokvei D34/40

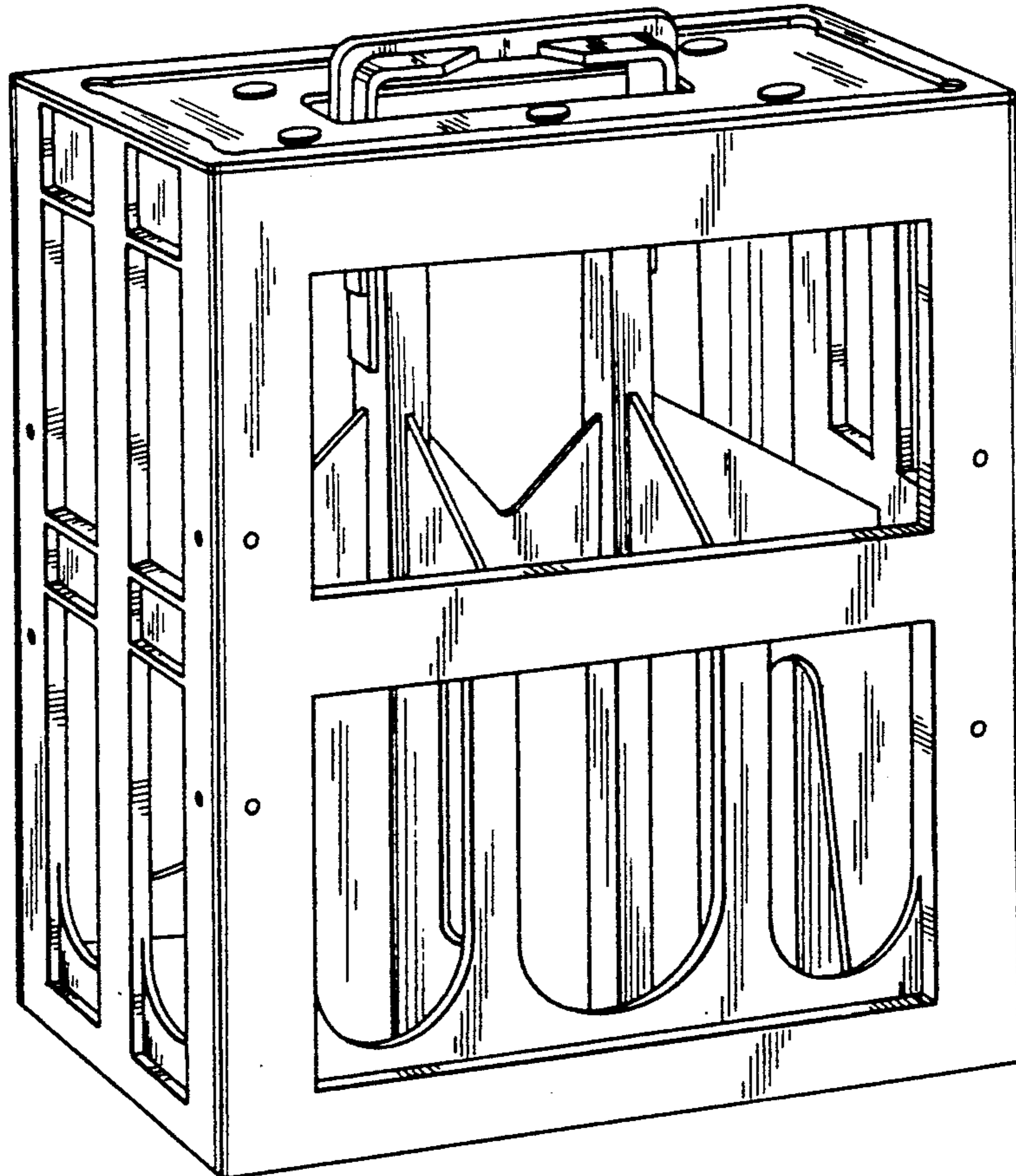

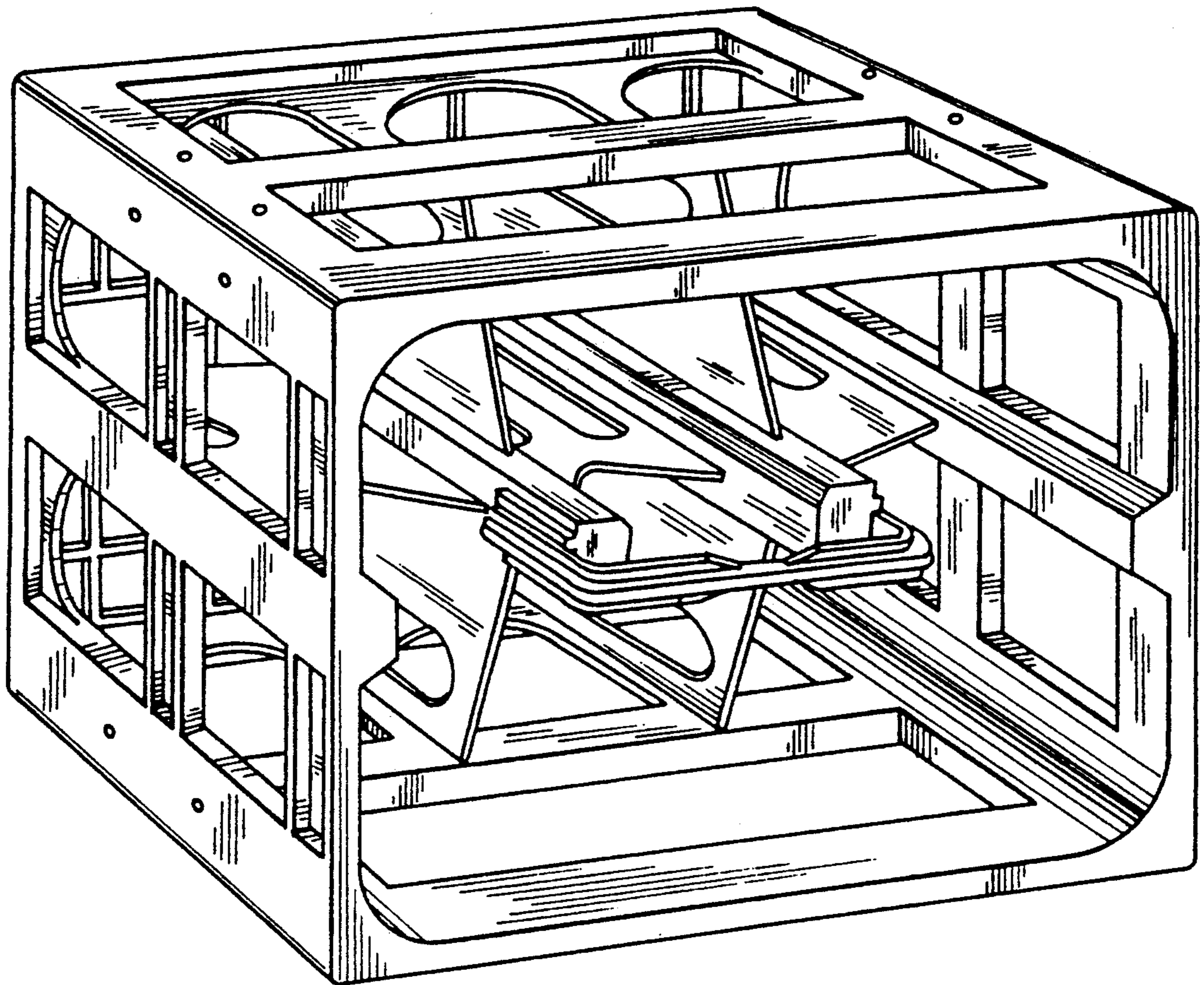

FIG. 1

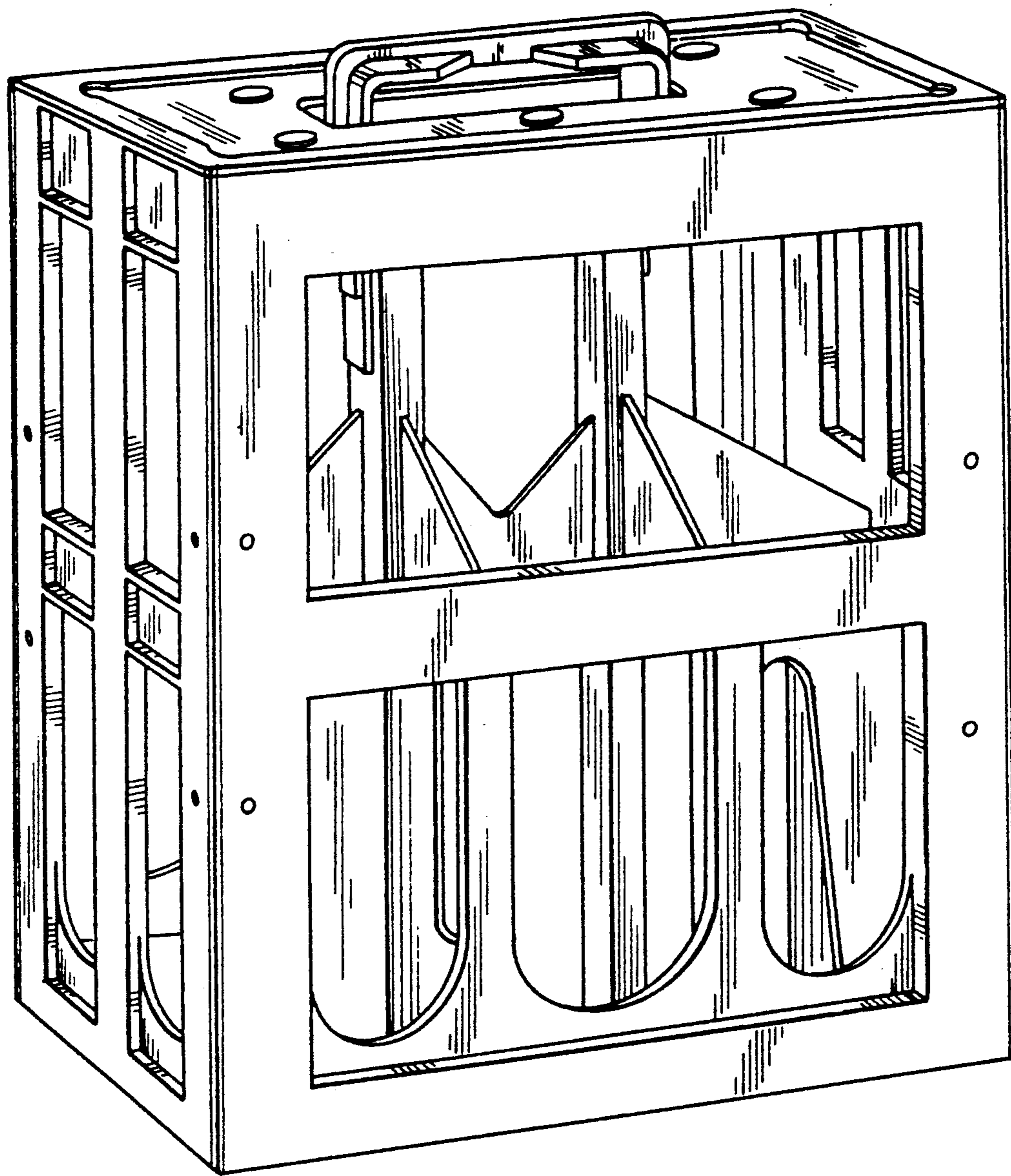

FIG. 2

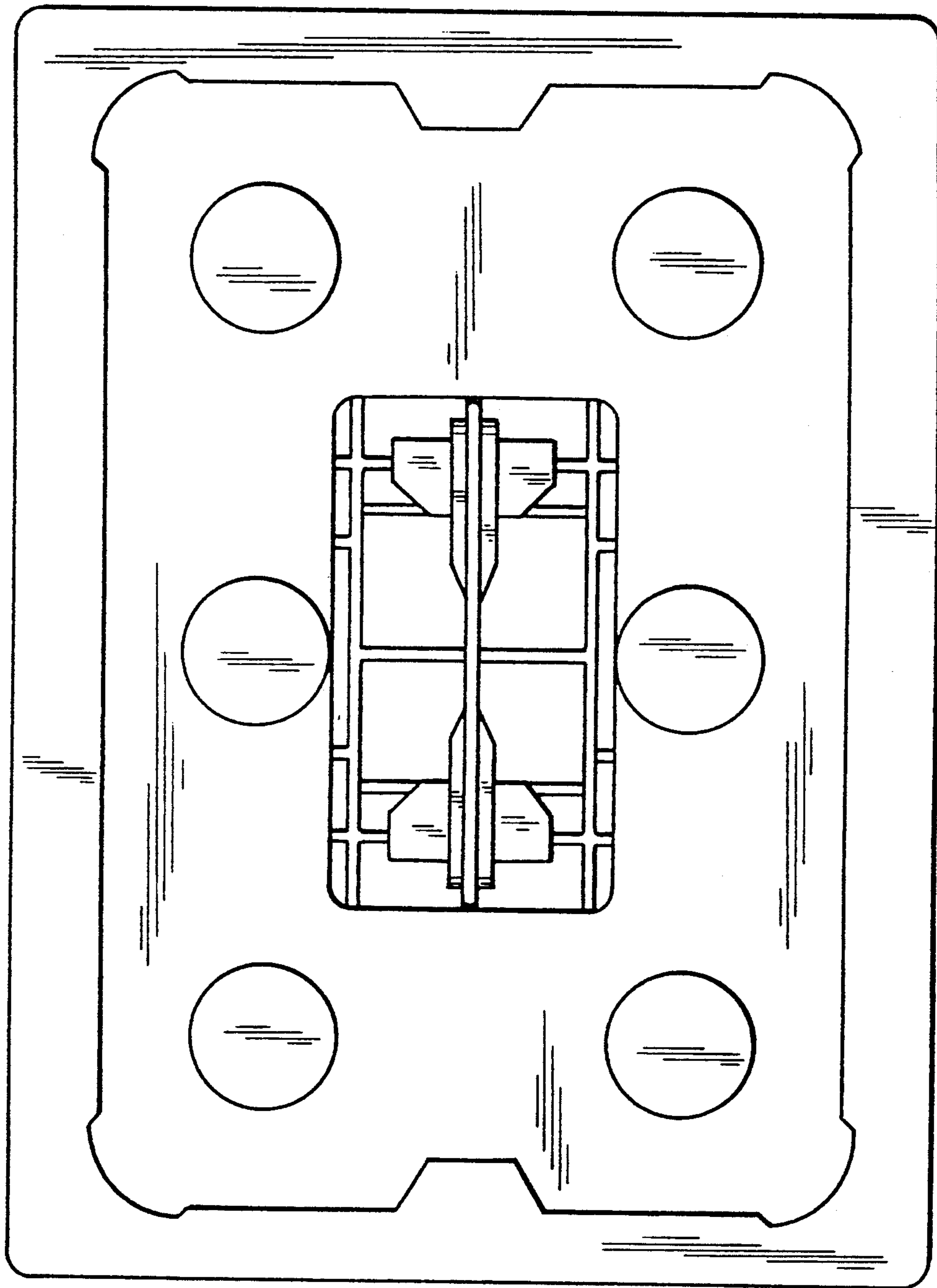

FIG. 3

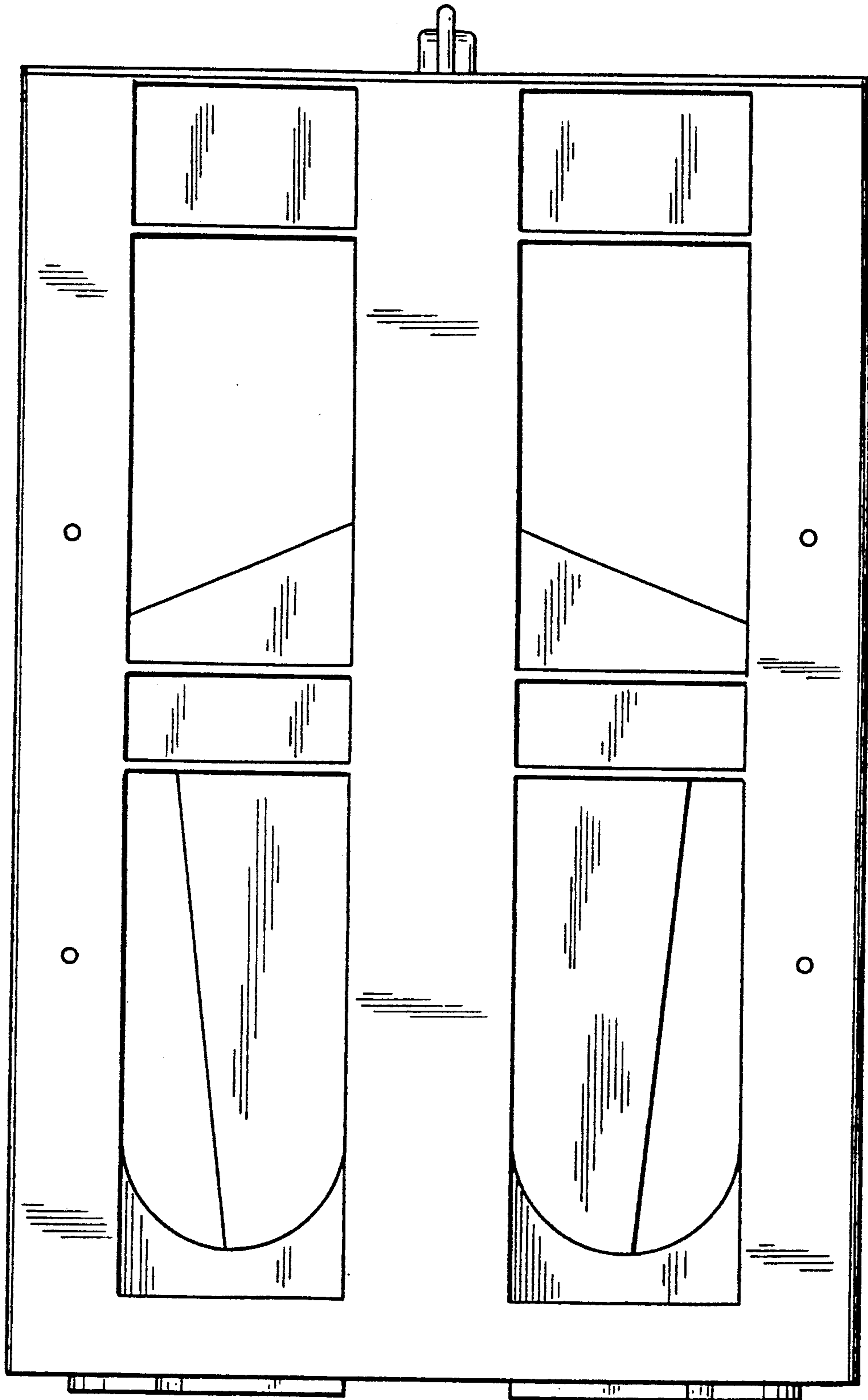

FIG. 4

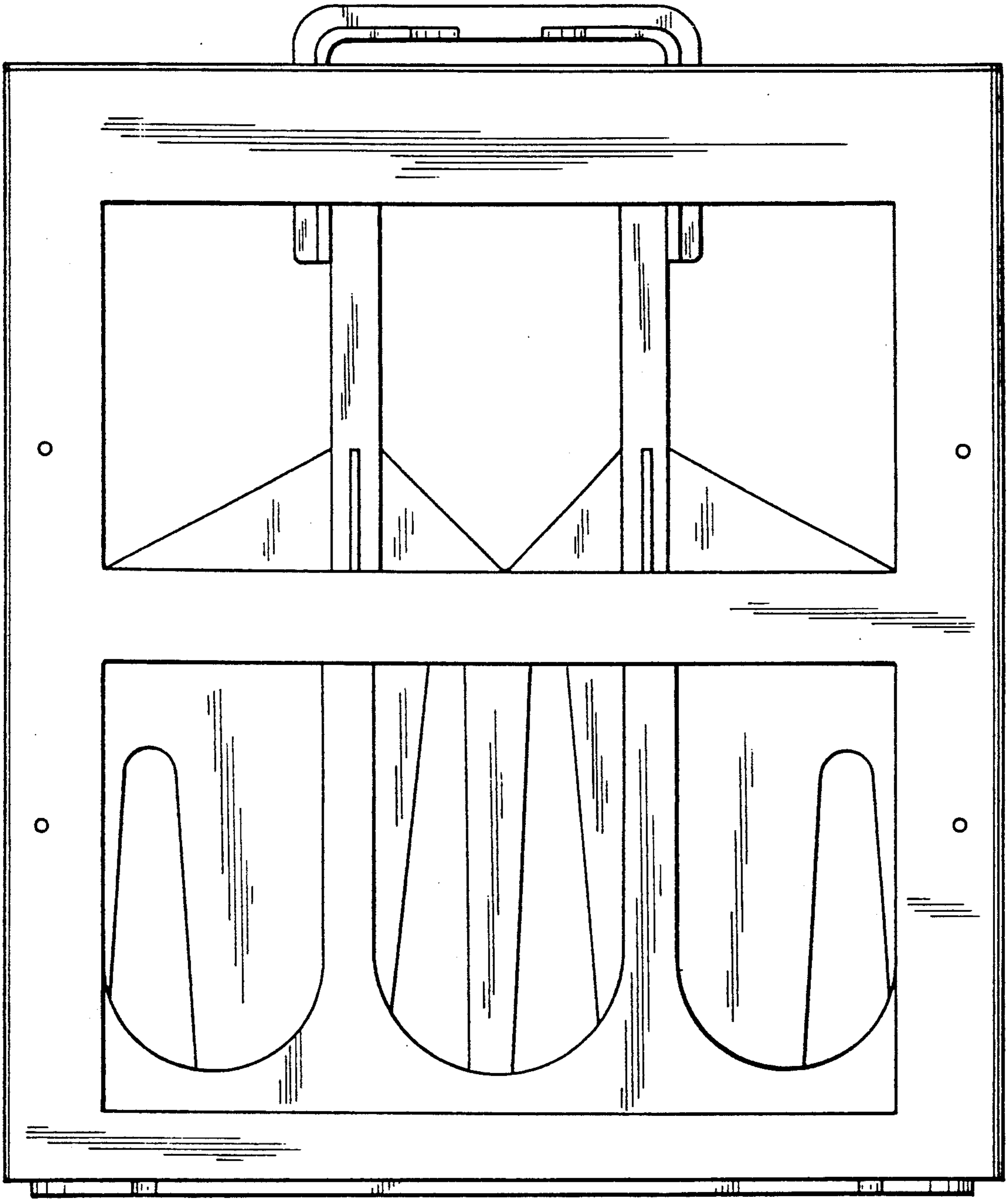

FIG. 5

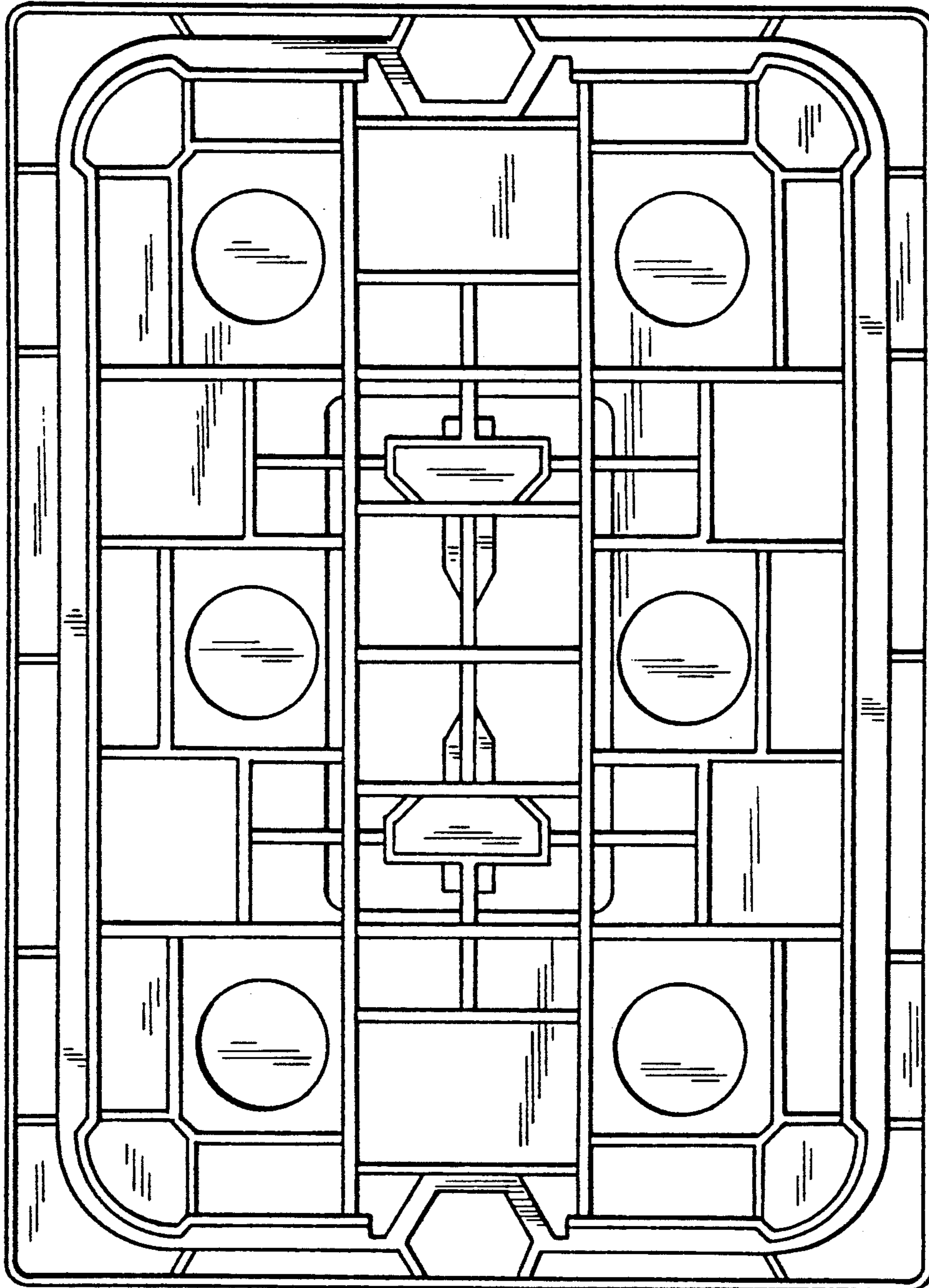

FIG. 6