



US00D331462S

United States Patent [19]

[11] Patent Number: **Des. 331,462**

Kraus et al.

[45] Date of Patent: **** Dec. 1, 1992**

[54] **SURGICAL CLIP**

[75] Inventors: **Robert G. Kraus, Attleboro; Philip C. Walker, Cambridge; Richard C. Schneider, Framingham, all of Mass.**

[73] Assignee: **Codman & Shurtleff, Inc., Randolph, Mass.**

[**] Term: **14 Years**

[21] Appl. No.: **559,789**

[22] Filed: **Jul. 30, 1990**

[52] U.S. Cl. **D24/143; D8/395**

[58] Field of Search **D24/143; D28/39, 40; D8/395; D11/215; 227/179, 180, 901; 606/142, 143, 157, 158; 24/562**

4,612,932	9/1986	Caspar et al. .	
4,616,651	10/1986	Golden .	
4,637,395	1/1987	Caspar et al. .	
4,638,804	1/1987	Jewusiak .	
4,671,278	6/1987	Chin .	
4,791,707	12/1988	Tucker .	
4,796,627	1/1989	Tucker	606/143
4,821,721	4/1989	Chin et al. .	
4,854,317	8/1989	Braun .	
5,035,692	7/1991	Lyon et al.	227/901 X

Primary Examiner—Louis S. Zarfes

[57] **CLAIM**

The ornamental design for a surgical clip, as shown and described.

DESCRIPTION

FIG. 1 is a perspective view of a surgical clip showing the front and top of our new design;
 FIG. 2 is a perspective view showing the rear and bottom thereof;
 FIG. 3 is a side elevational view thereof;
 FIG. 4 is a top plan view thereof;
 FIG. 5 is a bottom plan view thereof;
 FIG. 6 is a front elevational view thereof; and,
 FIG. 7 is a rear elevational view thereof.

[56] **References Cited**

U.S. PATENT DOCUMENTS

D. 134,886	1/1943	Forst	D8/395 X
D. 234,204	1/1975	Miller et al.	D8/395 X
3,446,212	5/1969	LeRoy .	
3,601,127	8/1971	Finegold	606/157 X
3,604,425	9/1971	LeRoy	606/158
4,217,902	8/1980	March .	
4,424,810	1/1984	Jewusiak .	

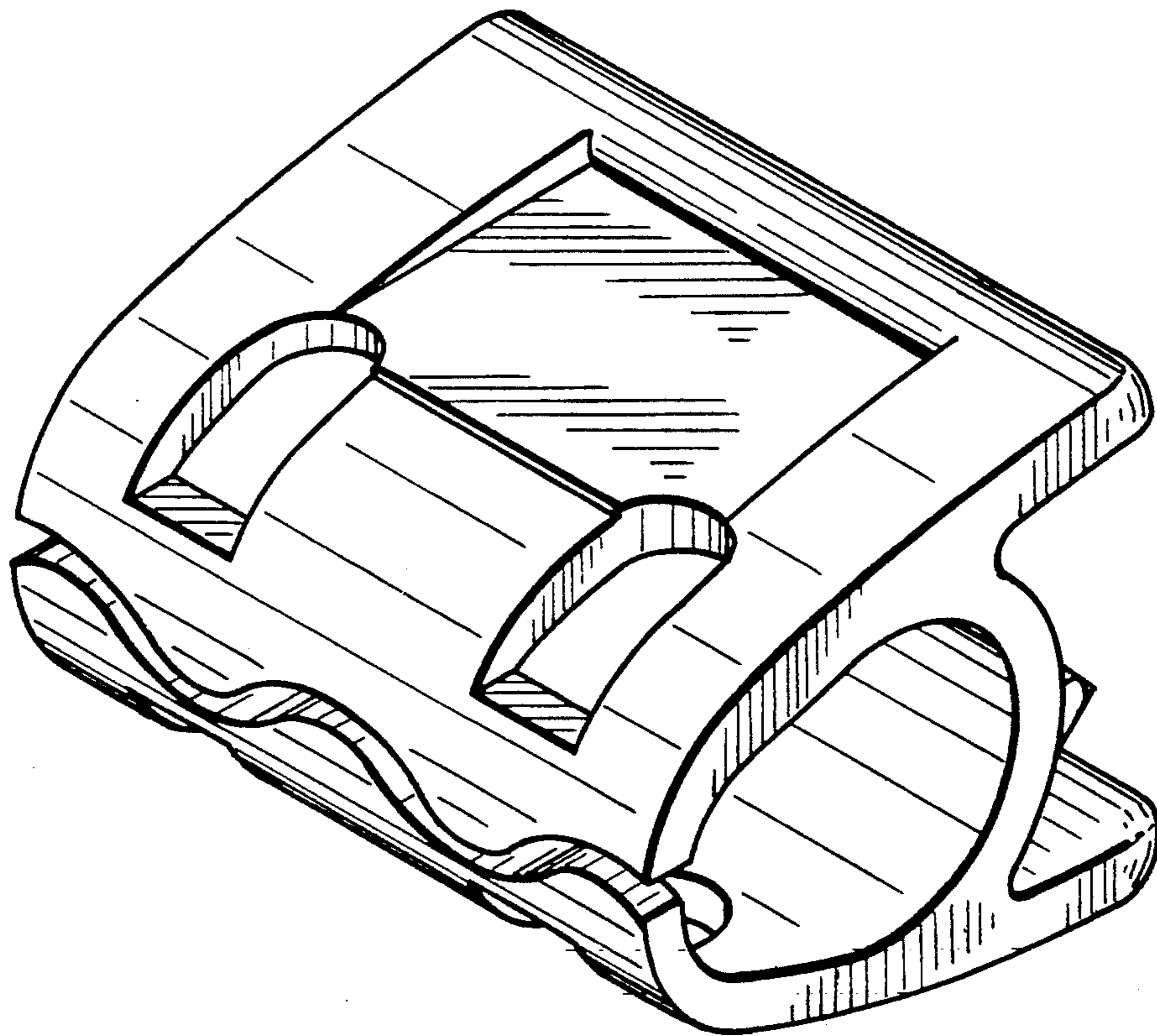

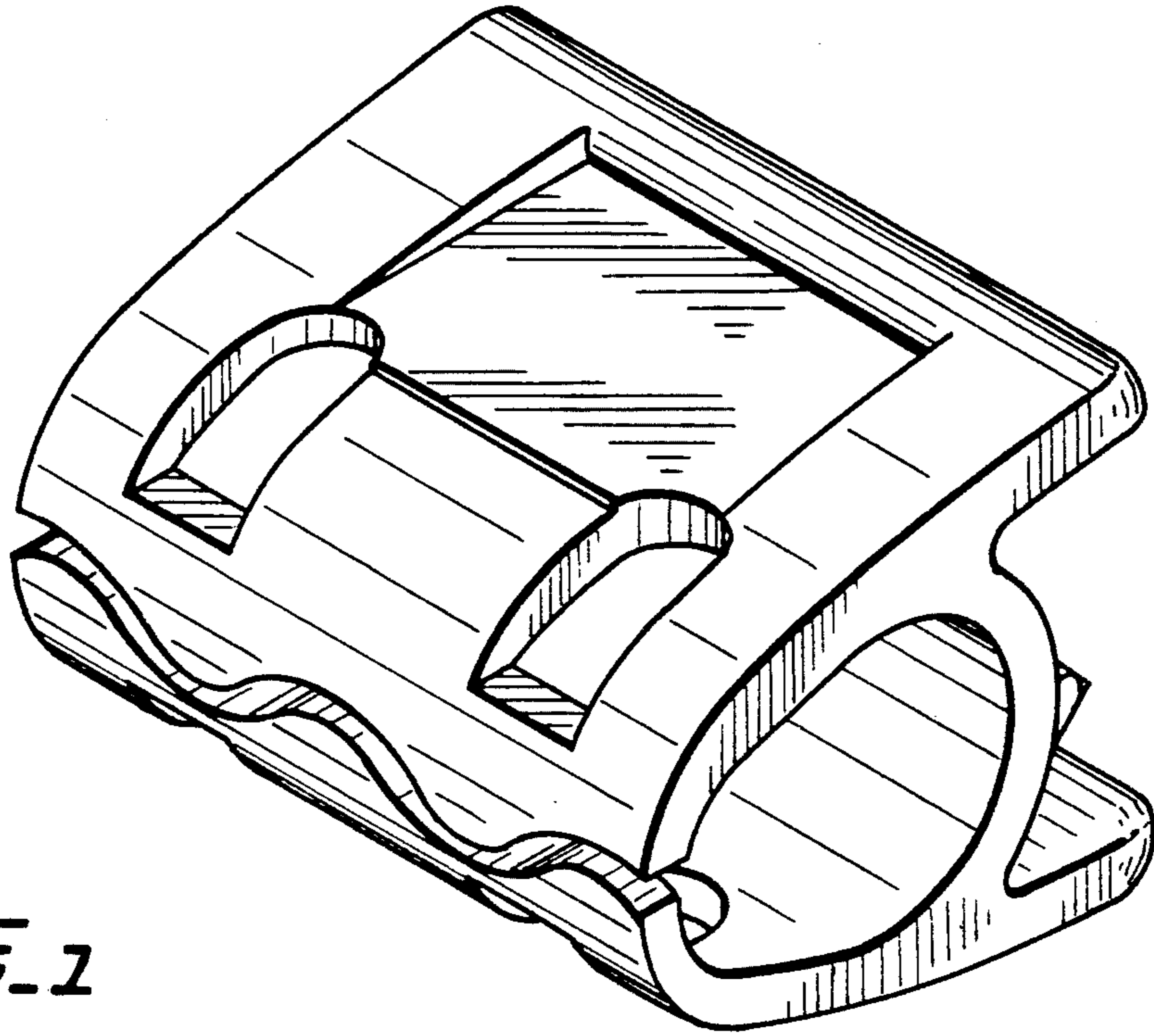

FIG. 1

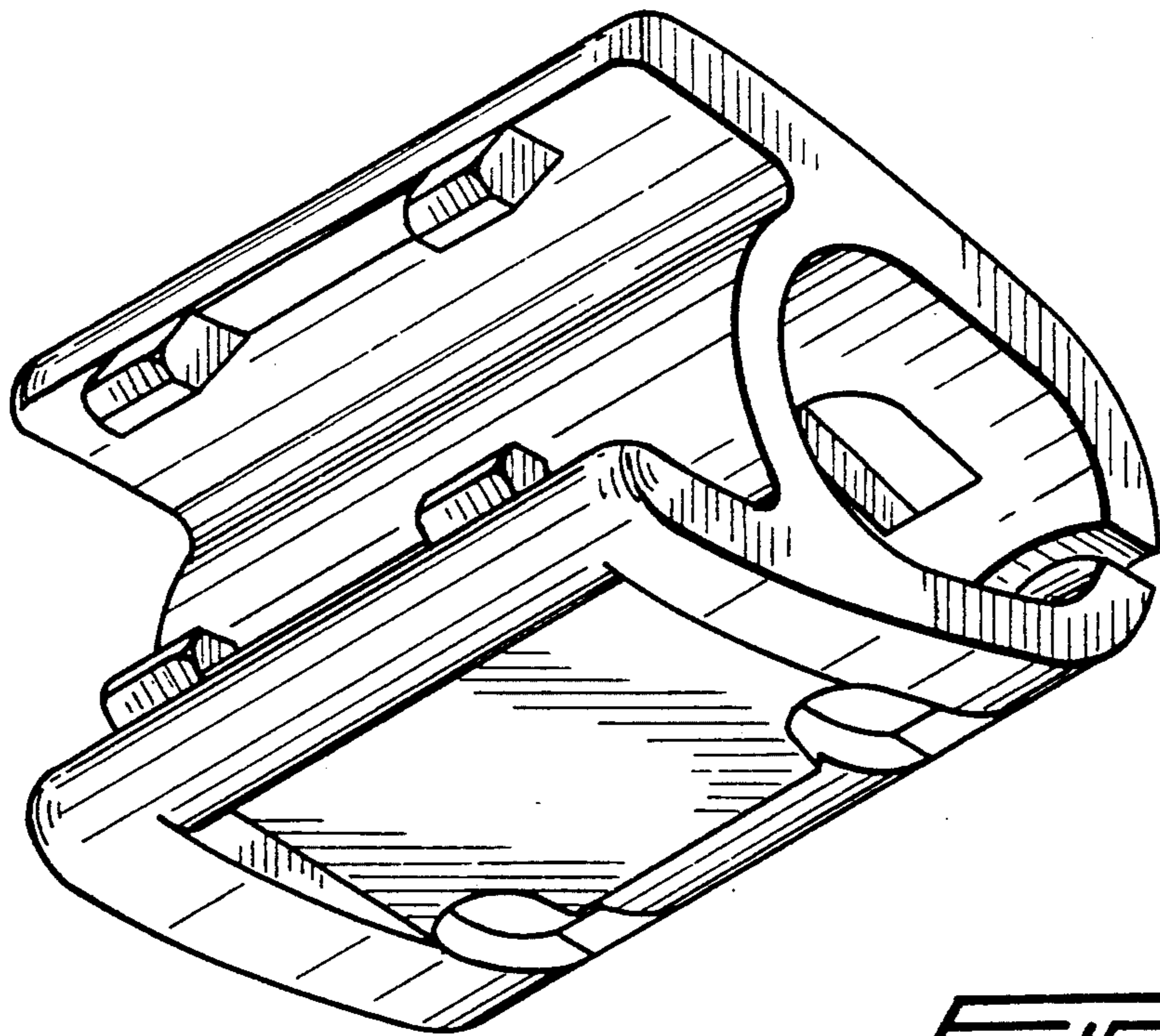

FIG. 2

FIG. 3

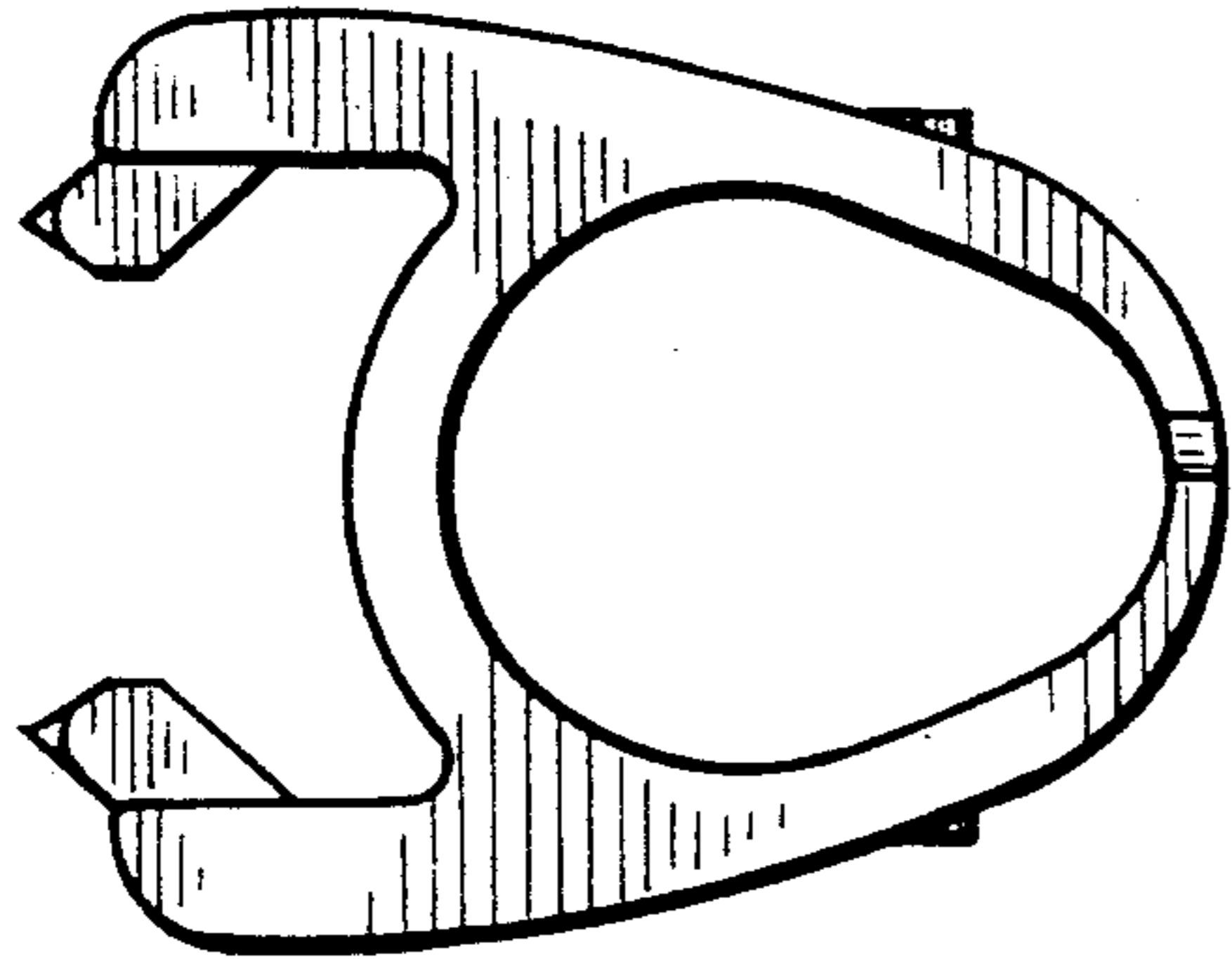

FIG. 6

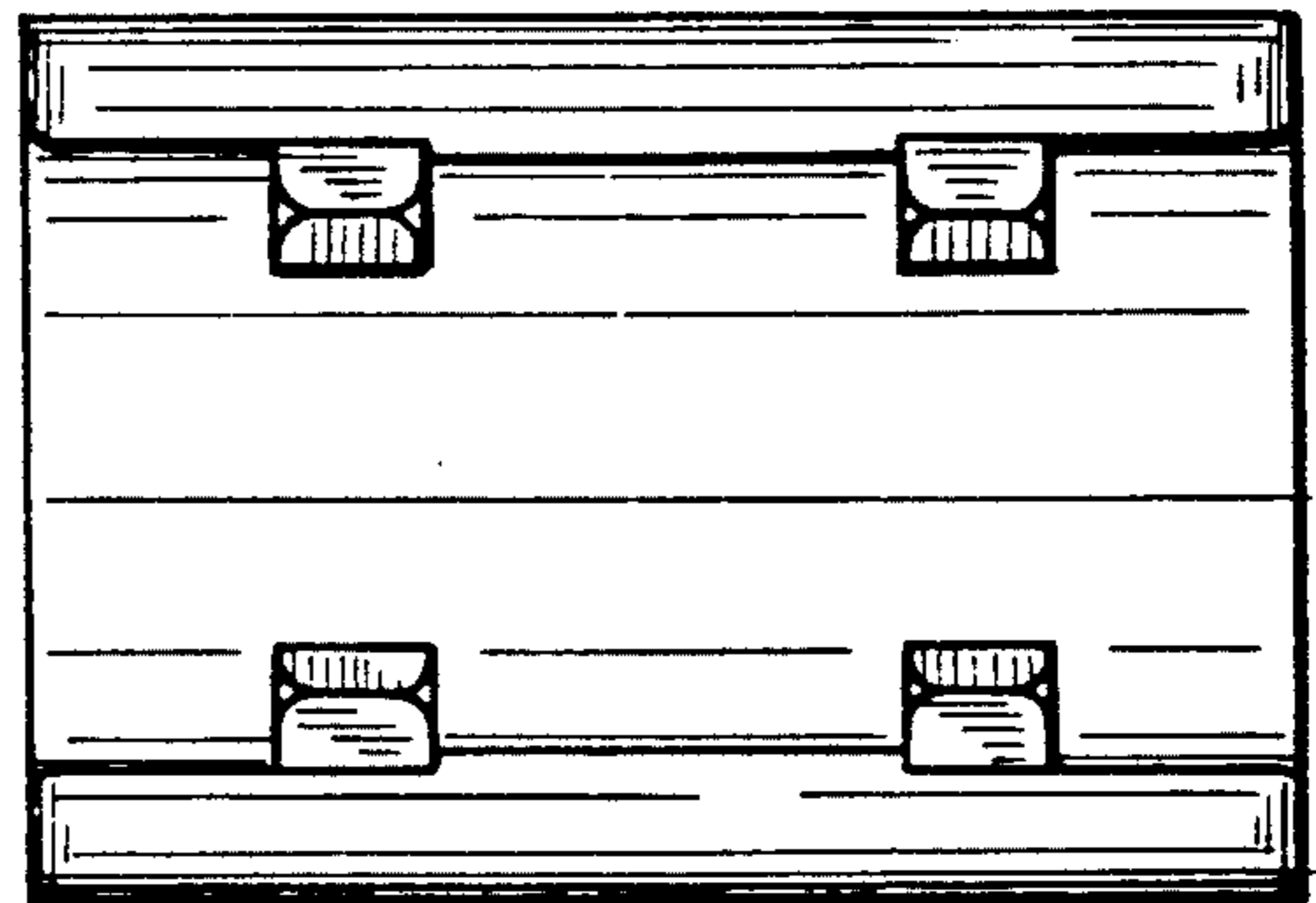
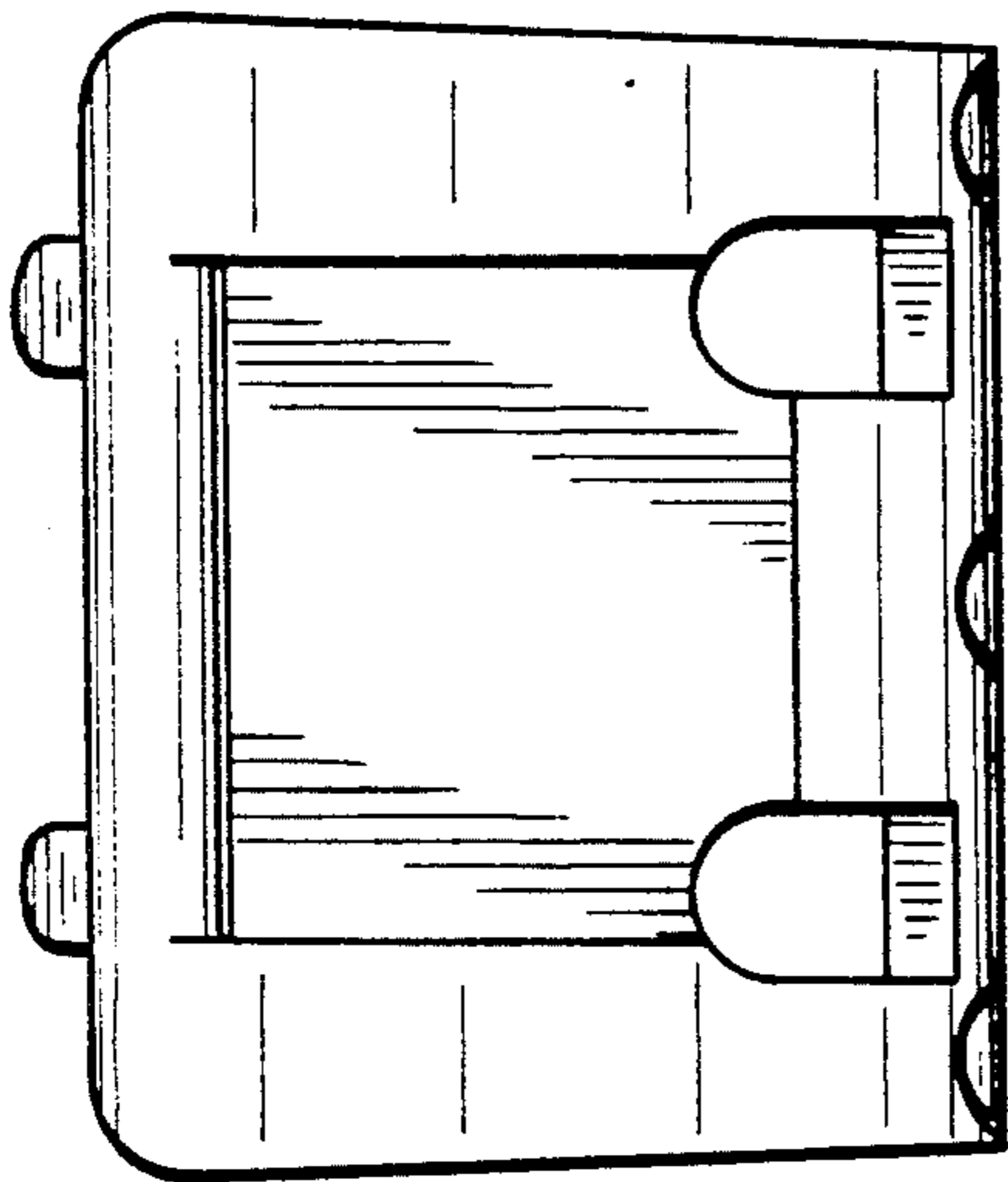
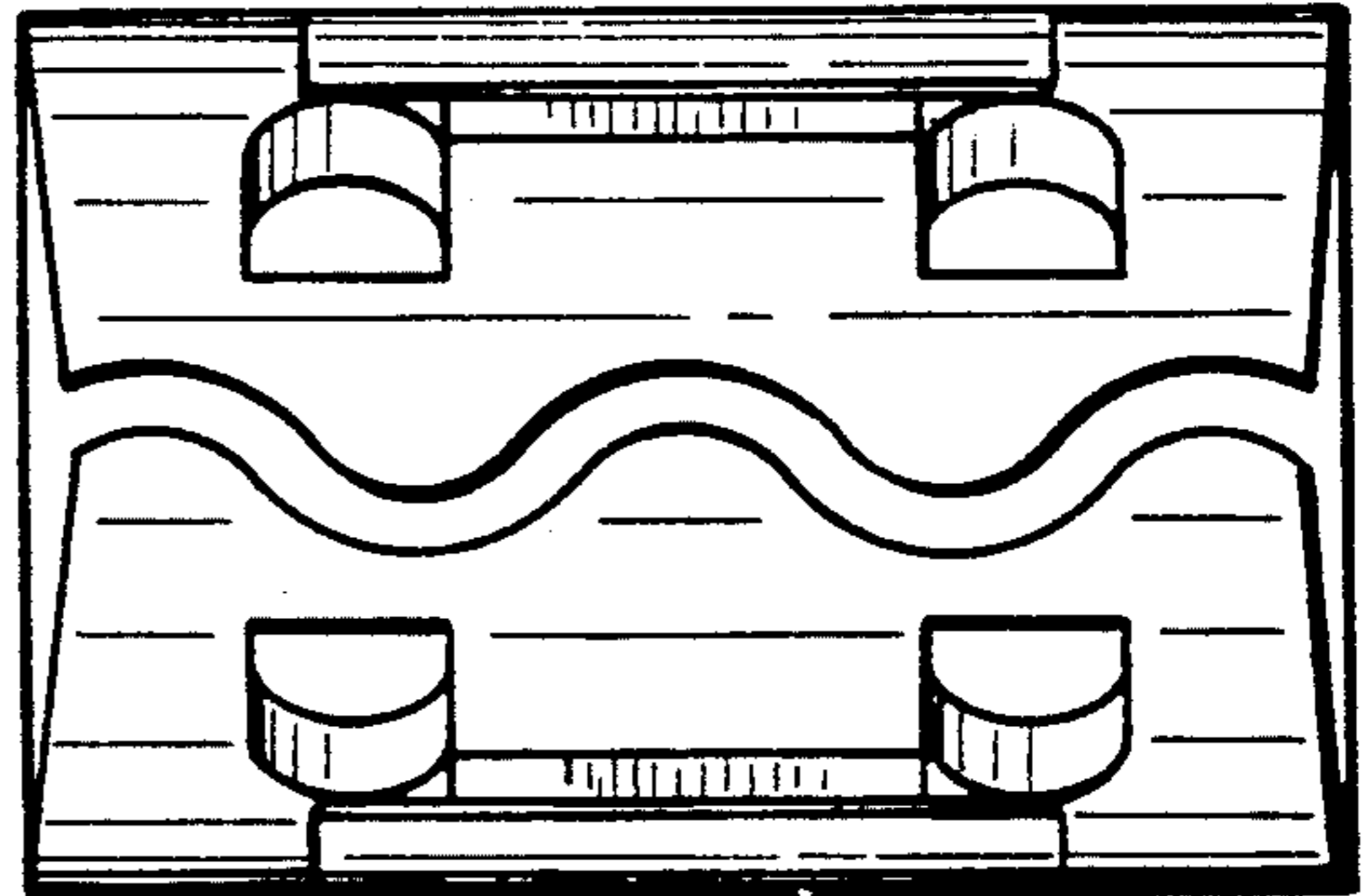

FIG. 4

FIG. 7

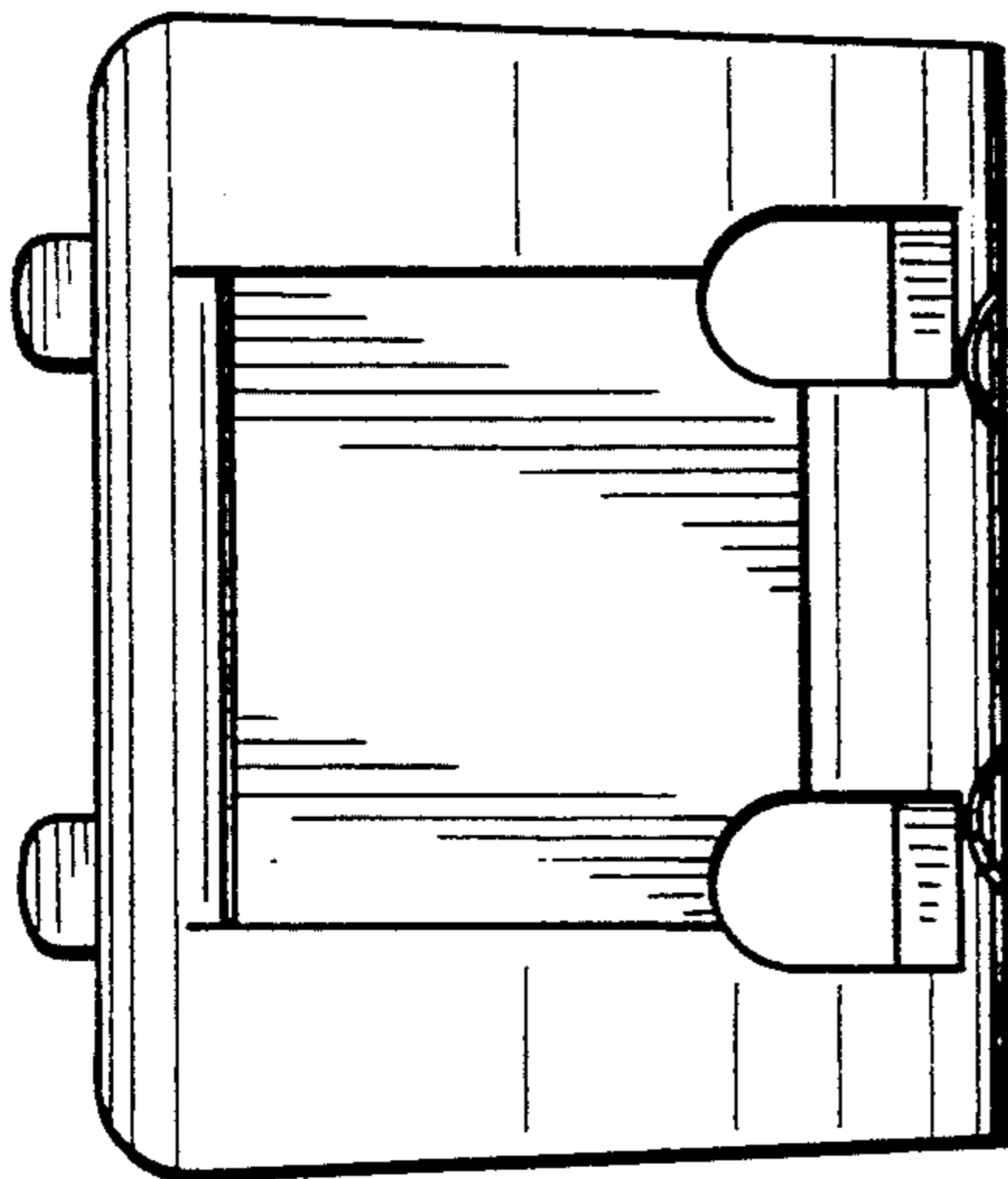

FIG. 5