



US00D331372S

United States Patent [19]

[11] Patent Number: **Des. 331,372**

Bankier et al.

[45] Date of Patent: **** Dec. 1, 1992**

[54] **WEIGH SCALE**

[75] Inventors: **Jack D. Bankier**, Northbrook, Ill.;
Kenneth Muderlak, Shorewood, Wis.

[73] Assignee: **Pelouze Scale Co.**, Evanston, Ill.

[**] Term: **14 Years**

[21] Appl. No.: **733,260**

[22] Filed: **Jul. 22, 1991**

[52] U.S. Cl. **D10/91**

[58] Field of Search **D10/83, 87, 88, 89,**
D10/91, 97; 177/172, 200, 211, 225, 238, 239,
240, 241, 242, 243, 251, 255

[56] **References Cited**

U.S. PATENT DOCUMENTS

- D. 231,016 3/1974 Zanuso D10/91
- D. 300,517 4/1989 Bankier et al. D10/91
- D. 309,868 8/1990 Busse D10/91
- 2,078,812 4/1937 Rüdiger 177/239 X

OTHER PUBLICATIONS

Industria Design, Terraillon's BA 2000 Kitchen Scale,
Jun. 1972, p. 55.

Hong Kong Enterprise, KL-7 Scale, Jan. 1986, p. 81.

Primary Examiner—Alan P. Douglas
Assistant Examiner—Antoine D. Davis
Attorney, Agent, or Firm—Augustus G. Douvas

[57] **CLAIM**

The ornamental design for a weigh scale, as shown.

DESCRIPTION

FIG. 1 is a top, front and left side perspective view of a weigh scale showing our new design;
 FIG. 2 is a front elevational view;
 FIG. 3 is a rear elevational view;
 FIG. 4 is a left side elevational view;
 FIG. 5 is a right side elevational view;
 FIG. 6 is a top plan view;
 FIG. 7 is a bottom plan view;
 FIG. 8 is a top, front and left side perspective view, shown with the weighing pan inverted on the scale's top surface;
 FIG. 9 is a front elevational view;
 FIG. 10 is a rear elevational view;
 FIG. 11 is a left side elevational view;
 FIG. 12 is a right side elevational view;
 FIG. 13 is a top plan view; and,
 FIG. 14 is a bottom plan view thereof.

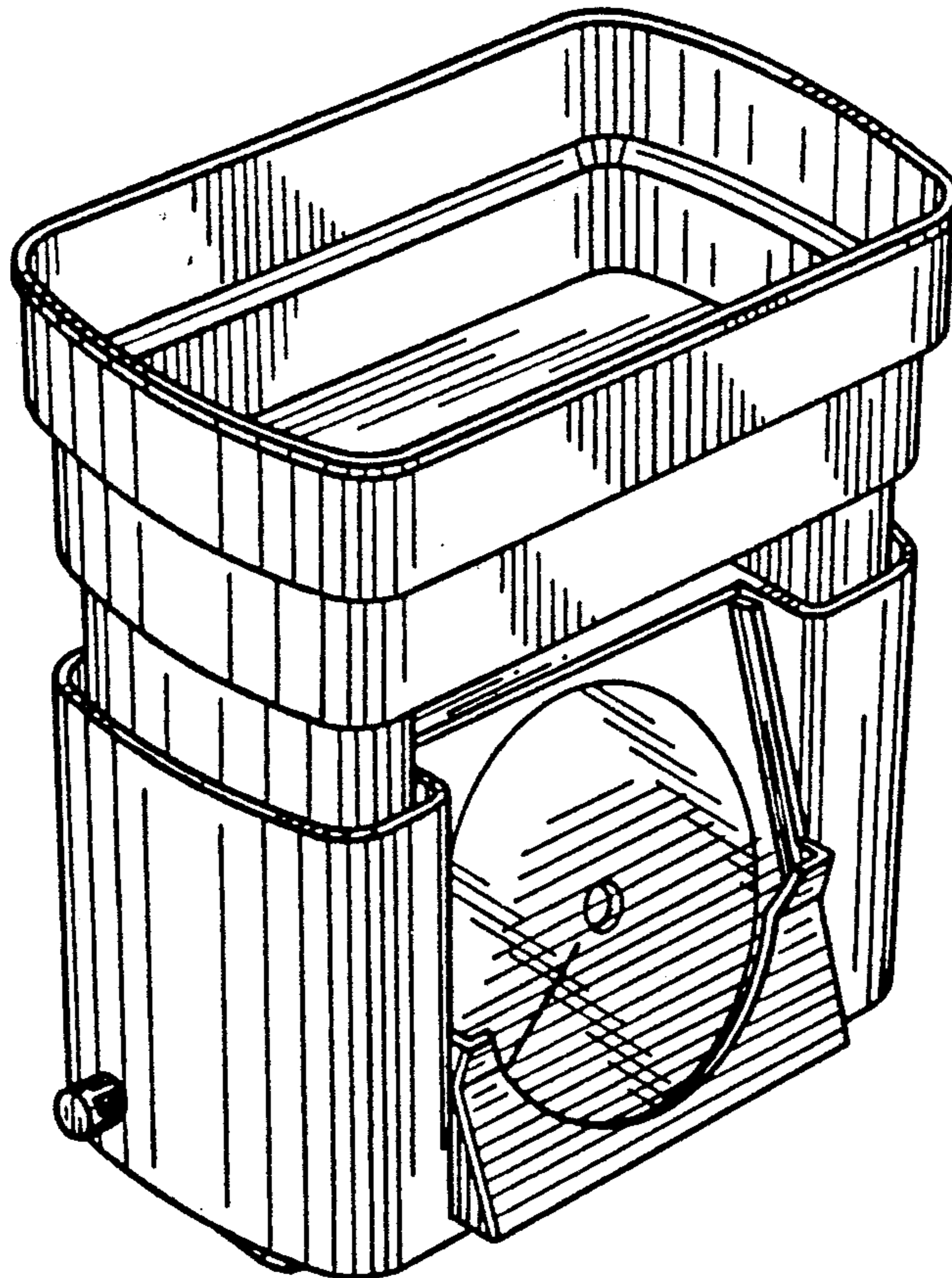

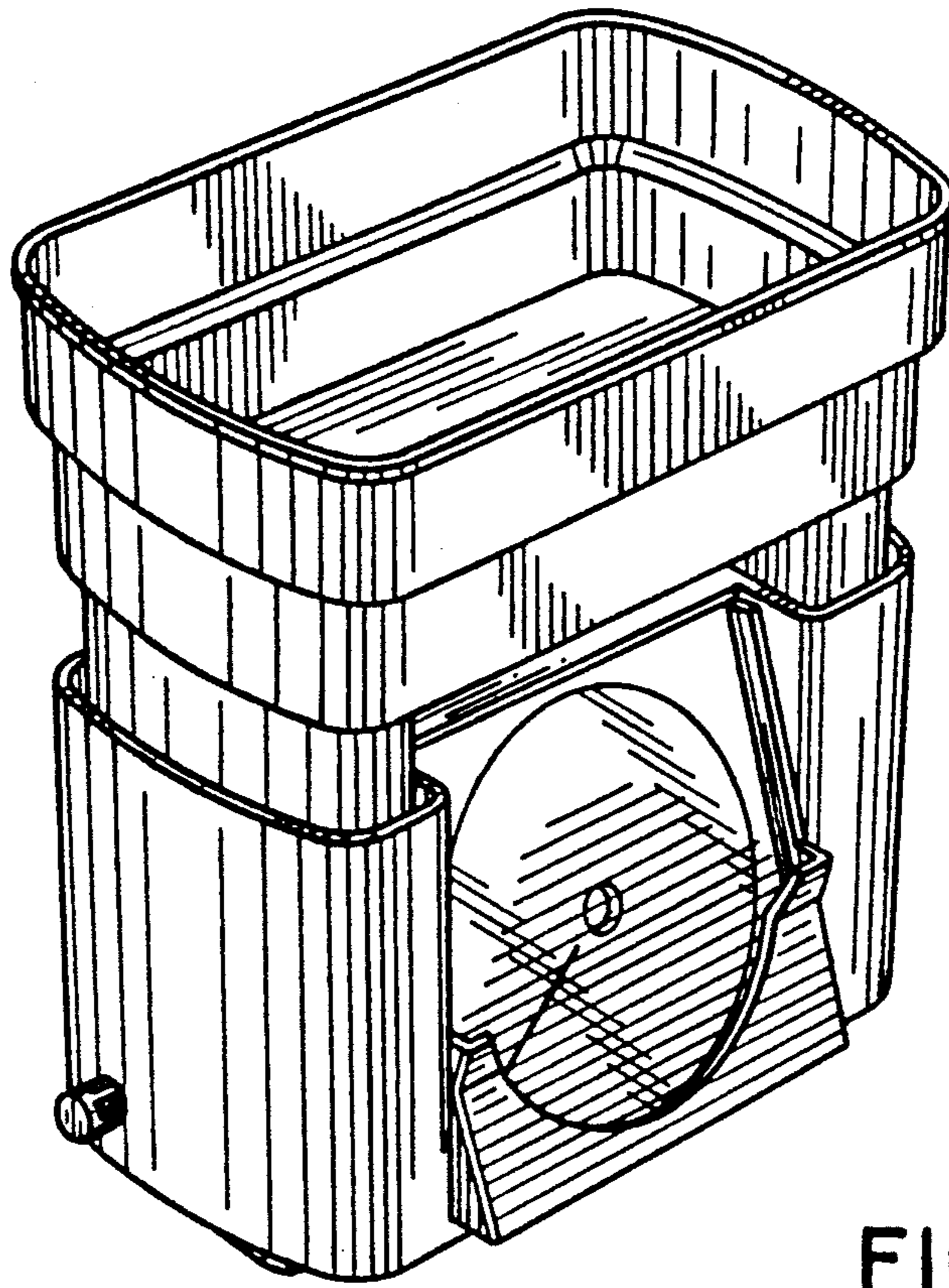

FIG. 1

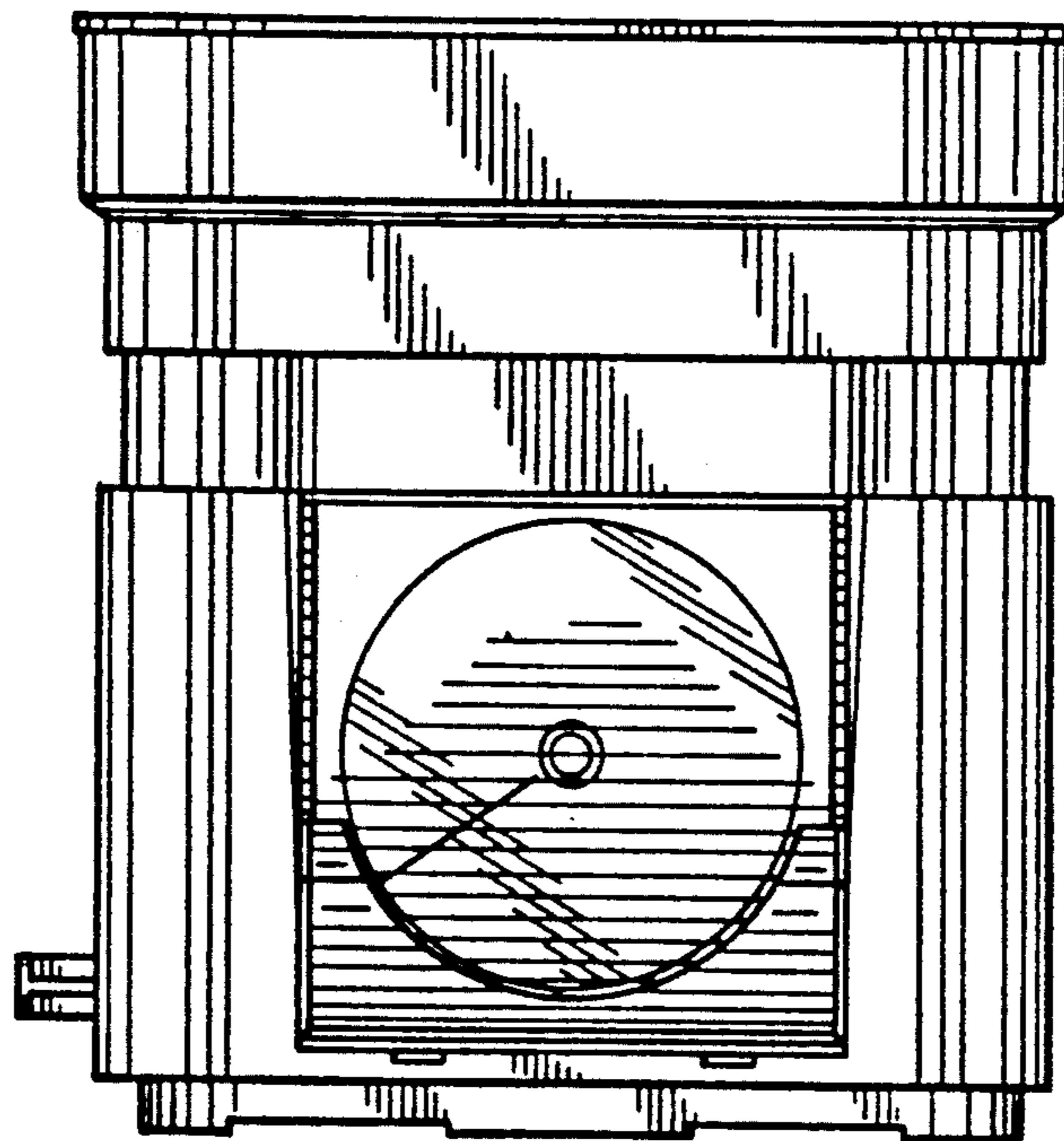

FIG. 2

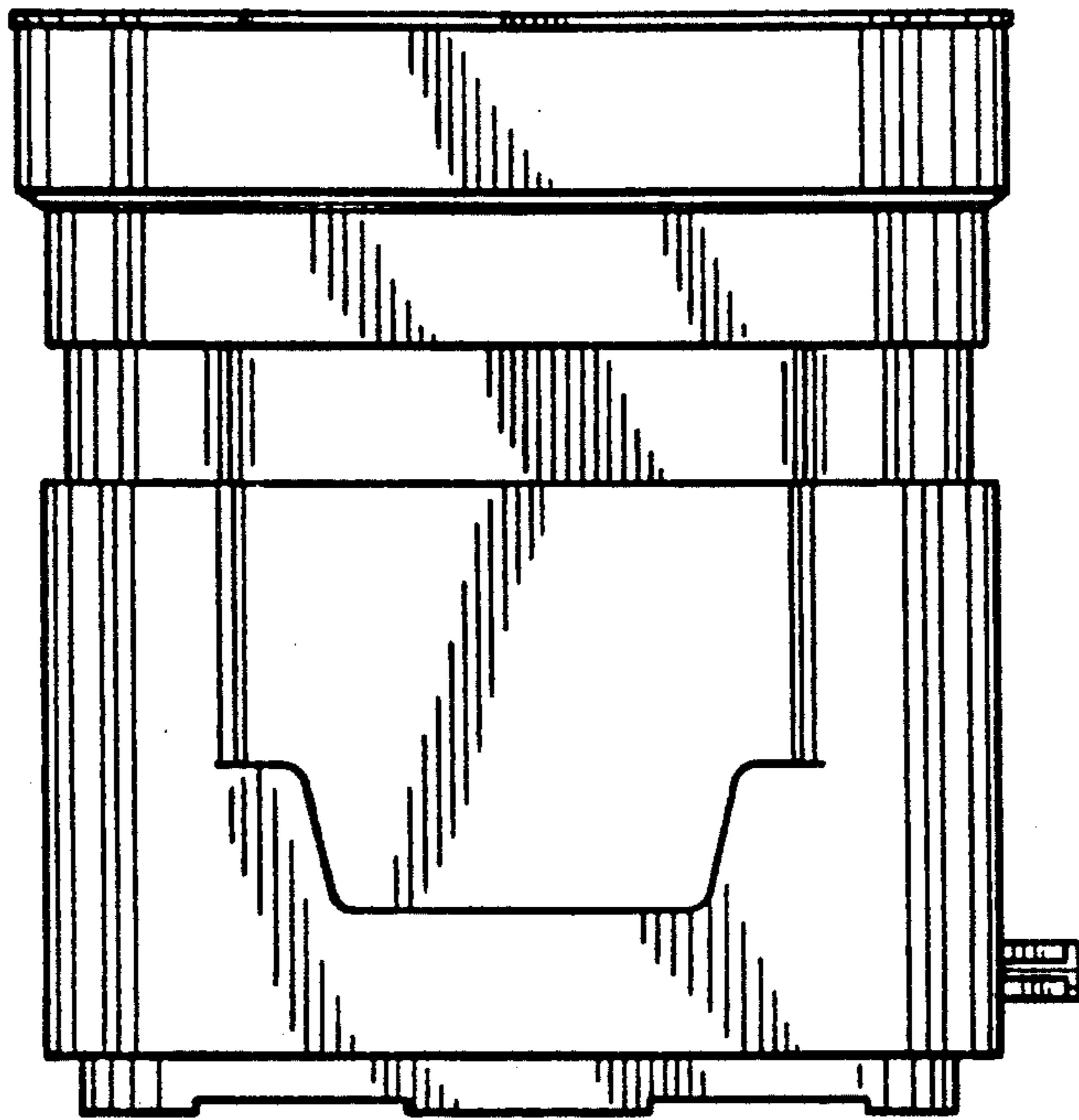

FIG. 3

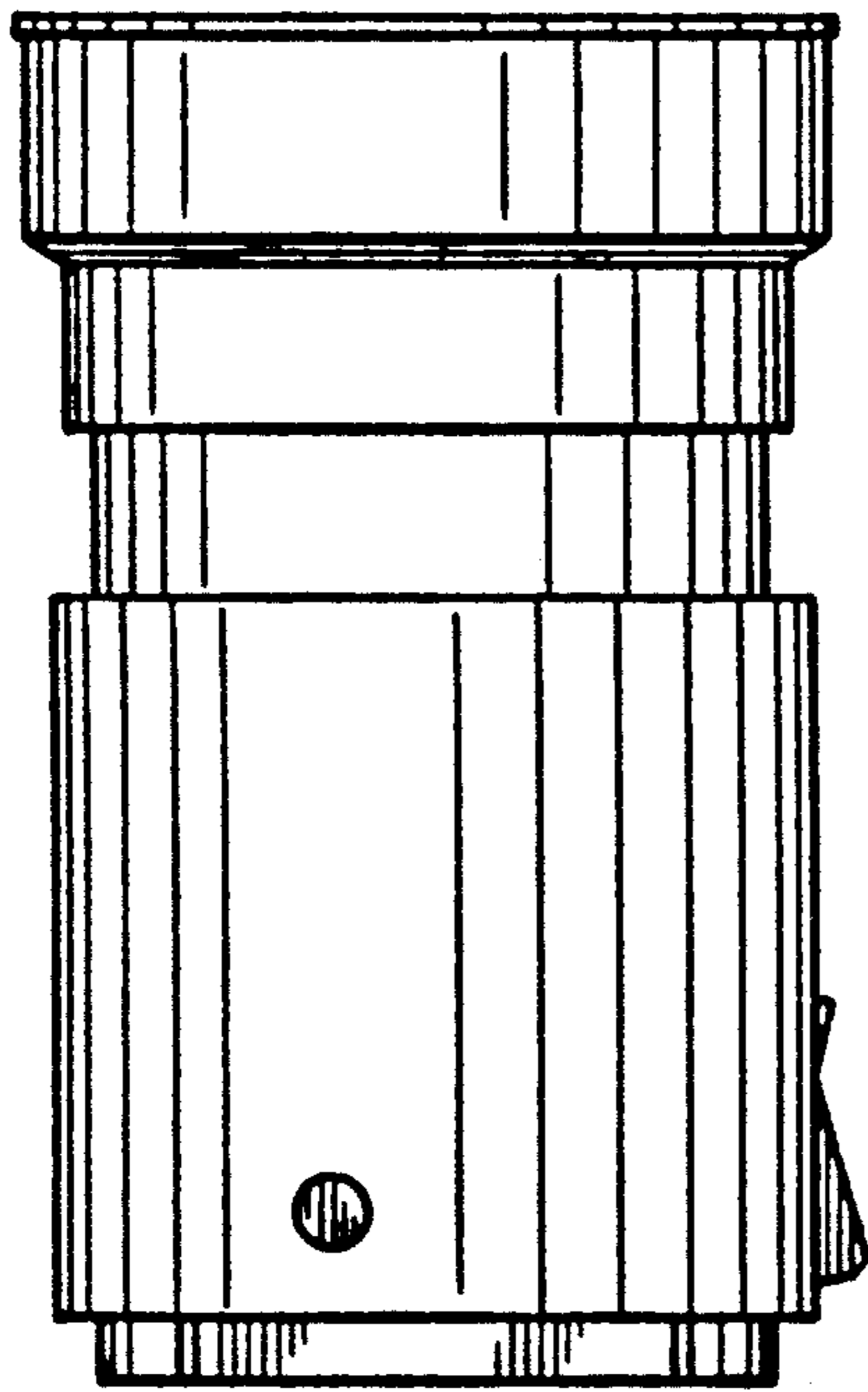

FIG. 4

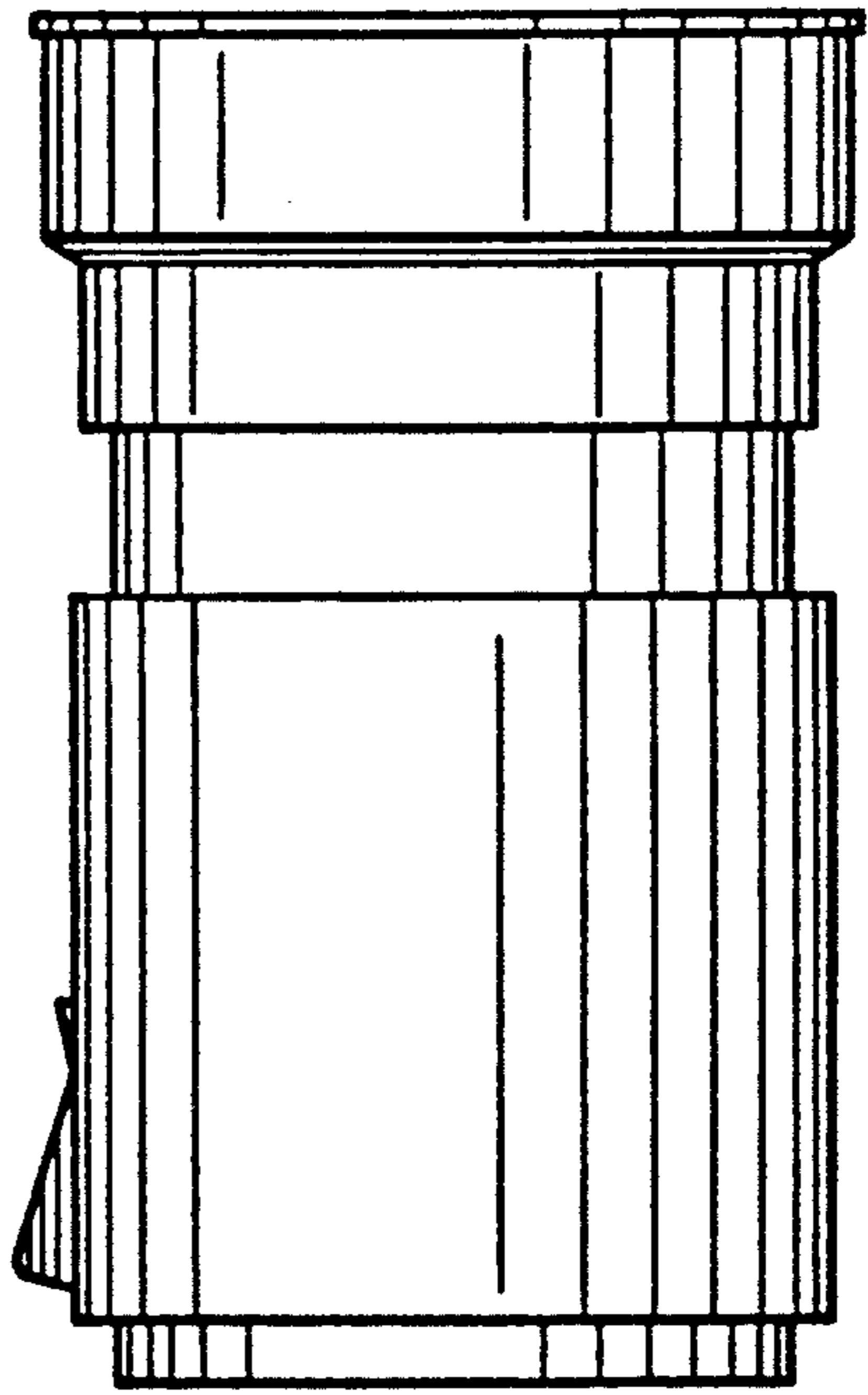

FIG. 5

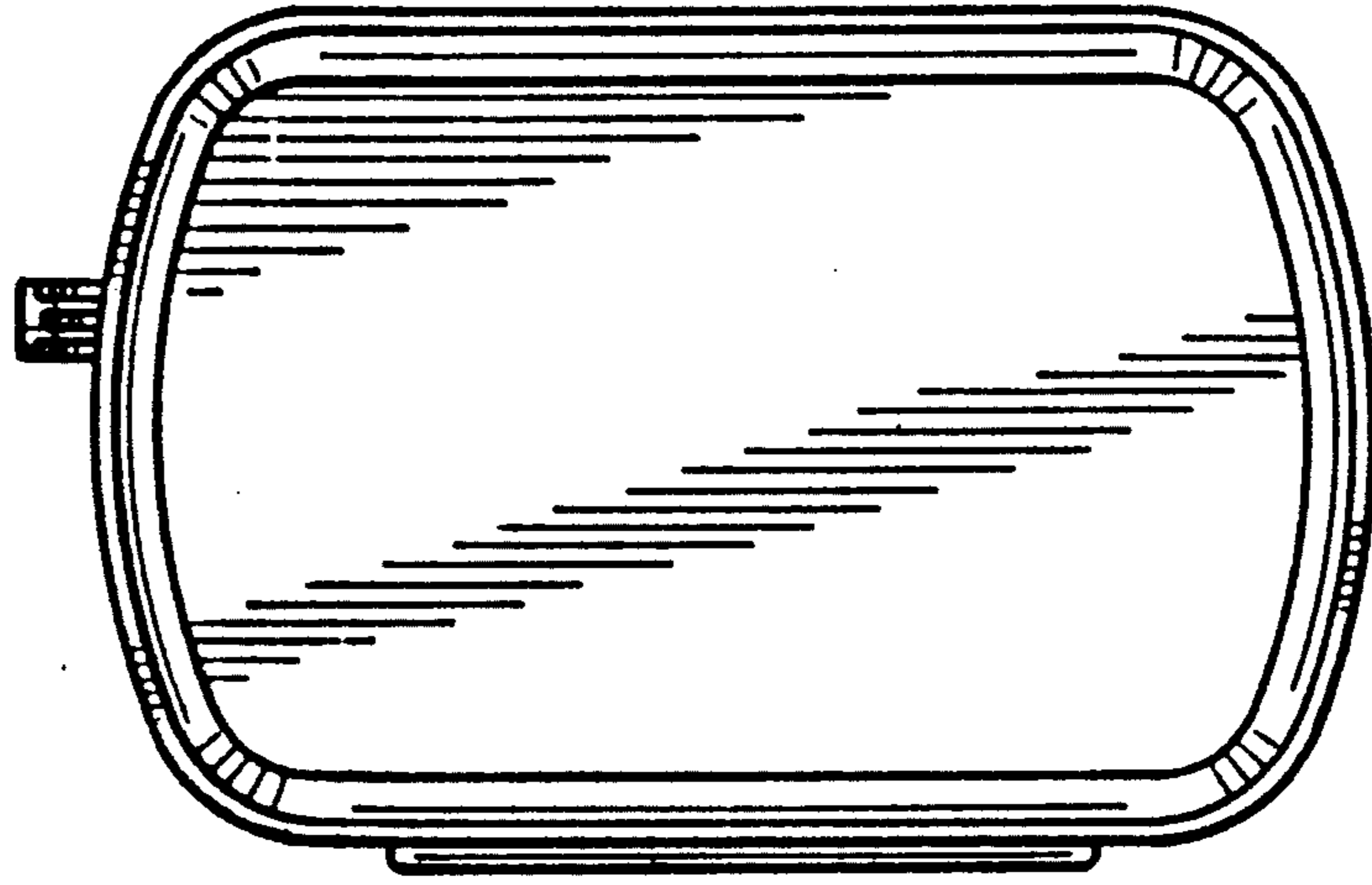

FIG. 6

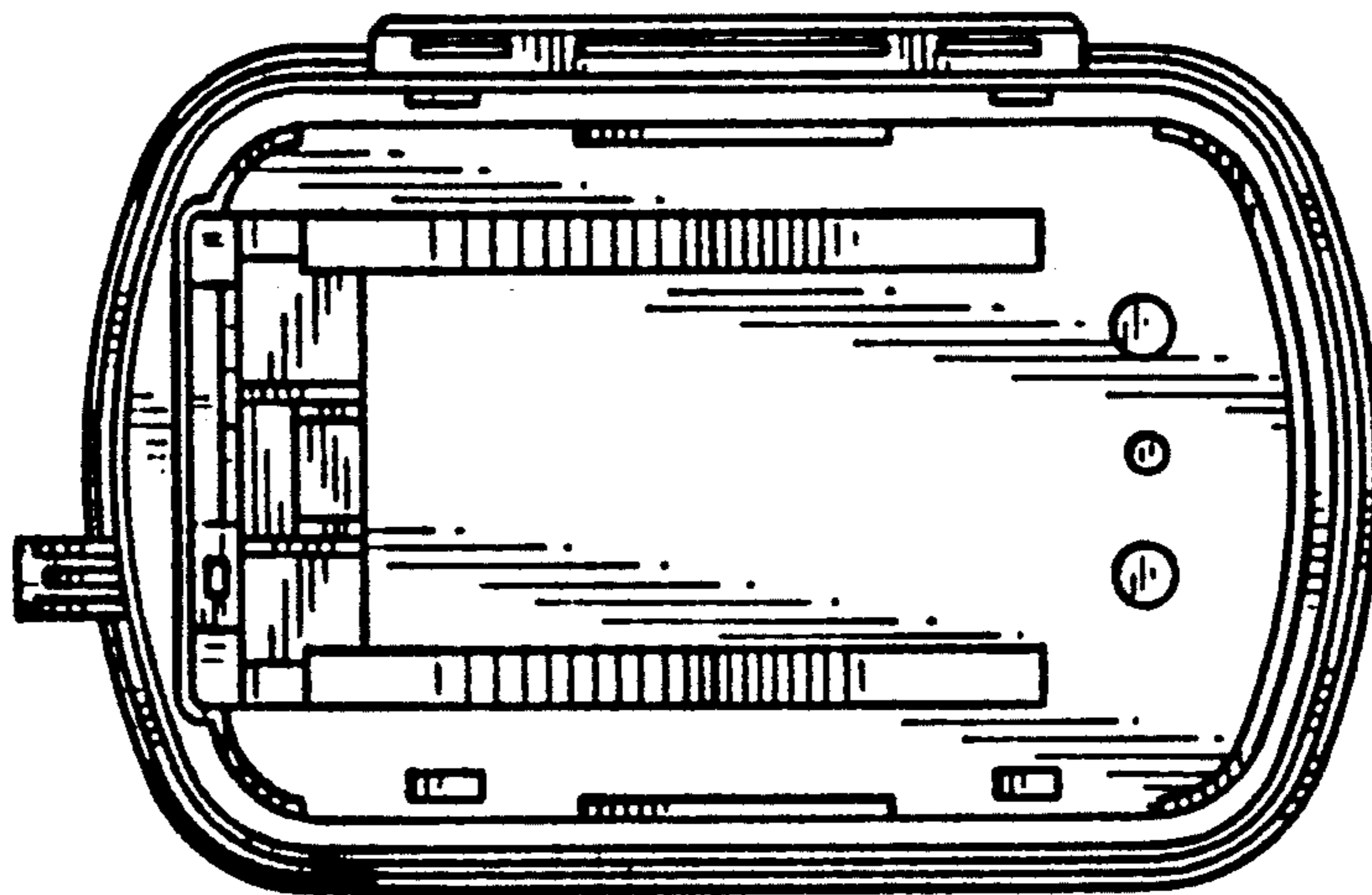

FIG. 7

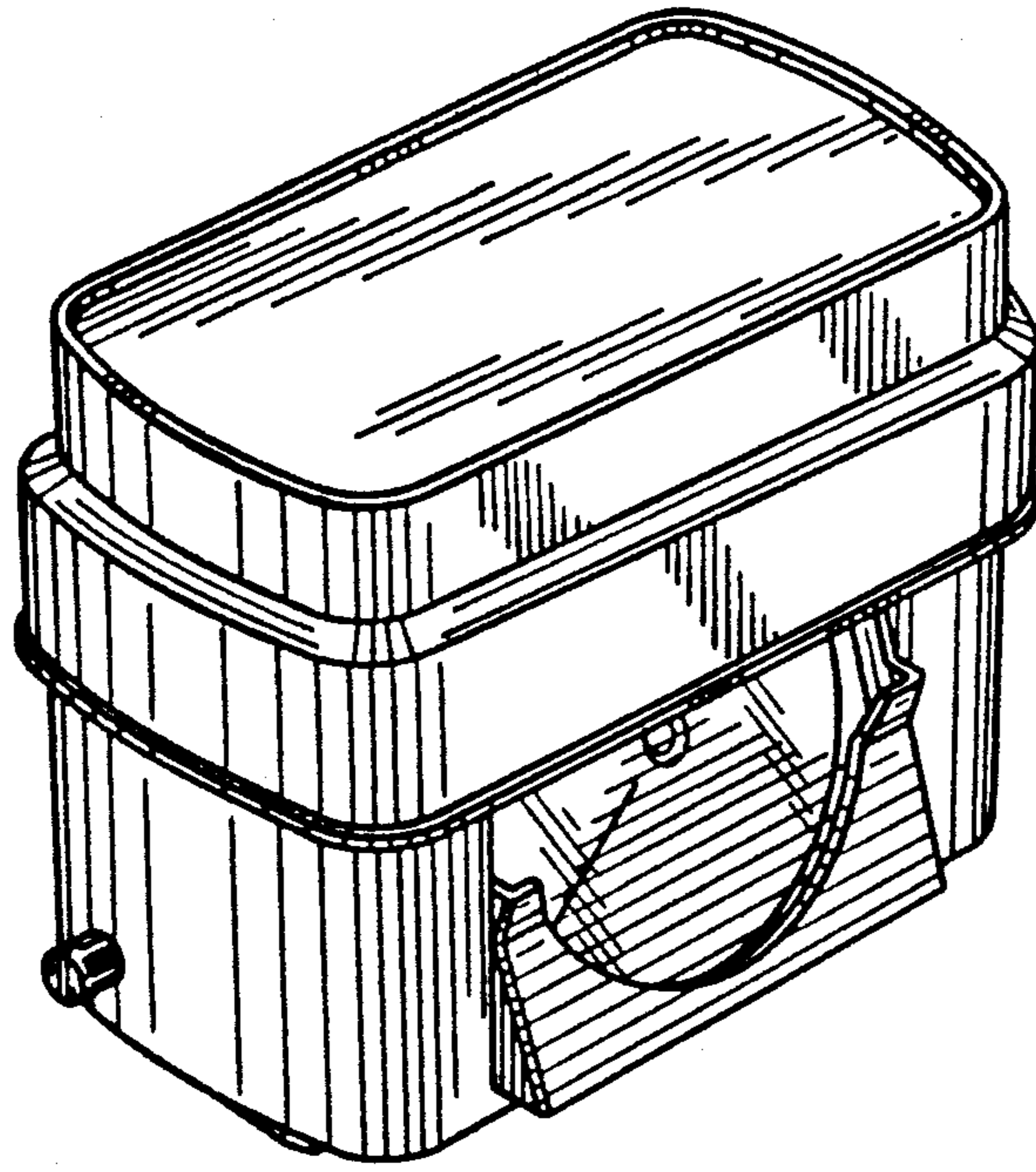

FIG. 8

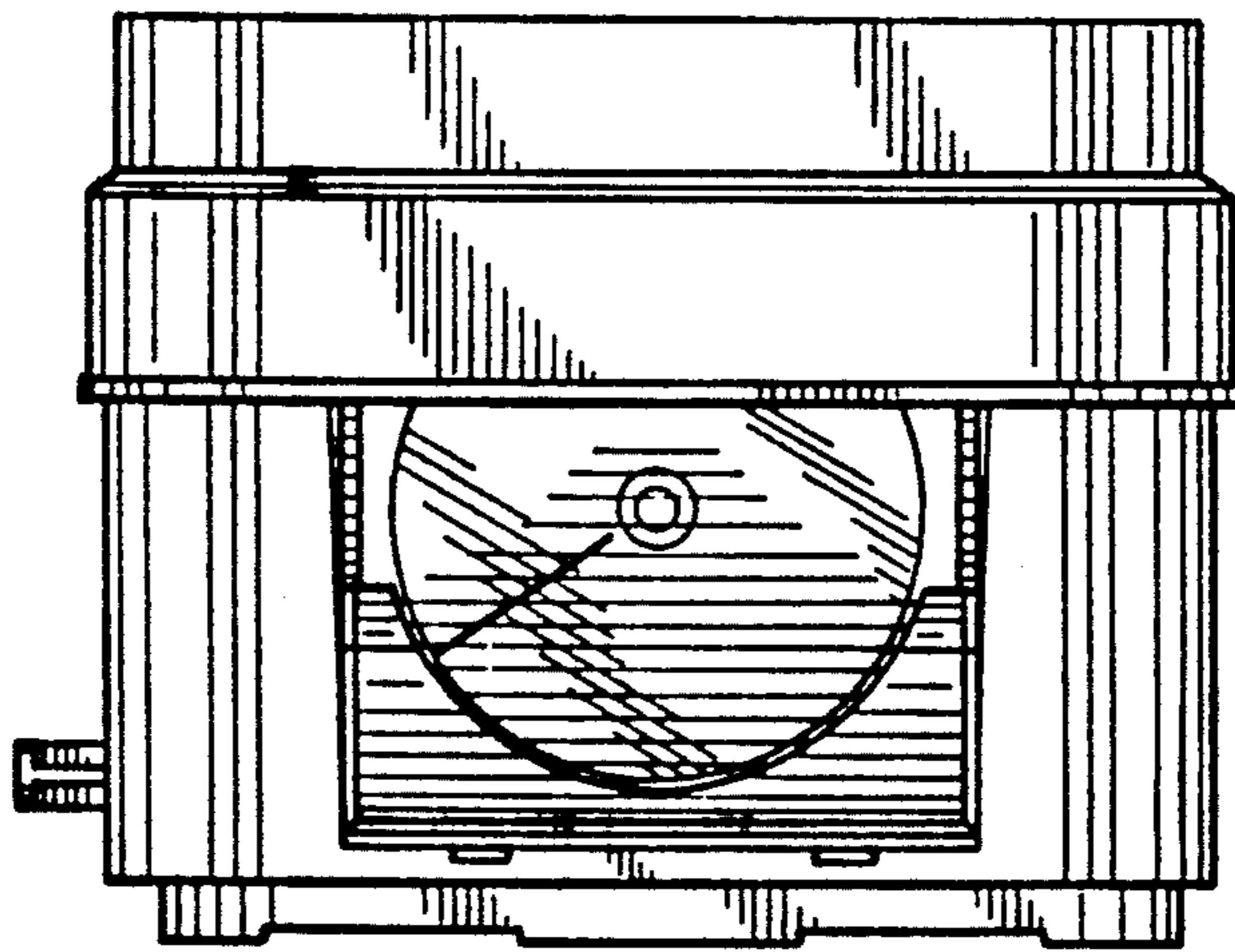

FIG. 9

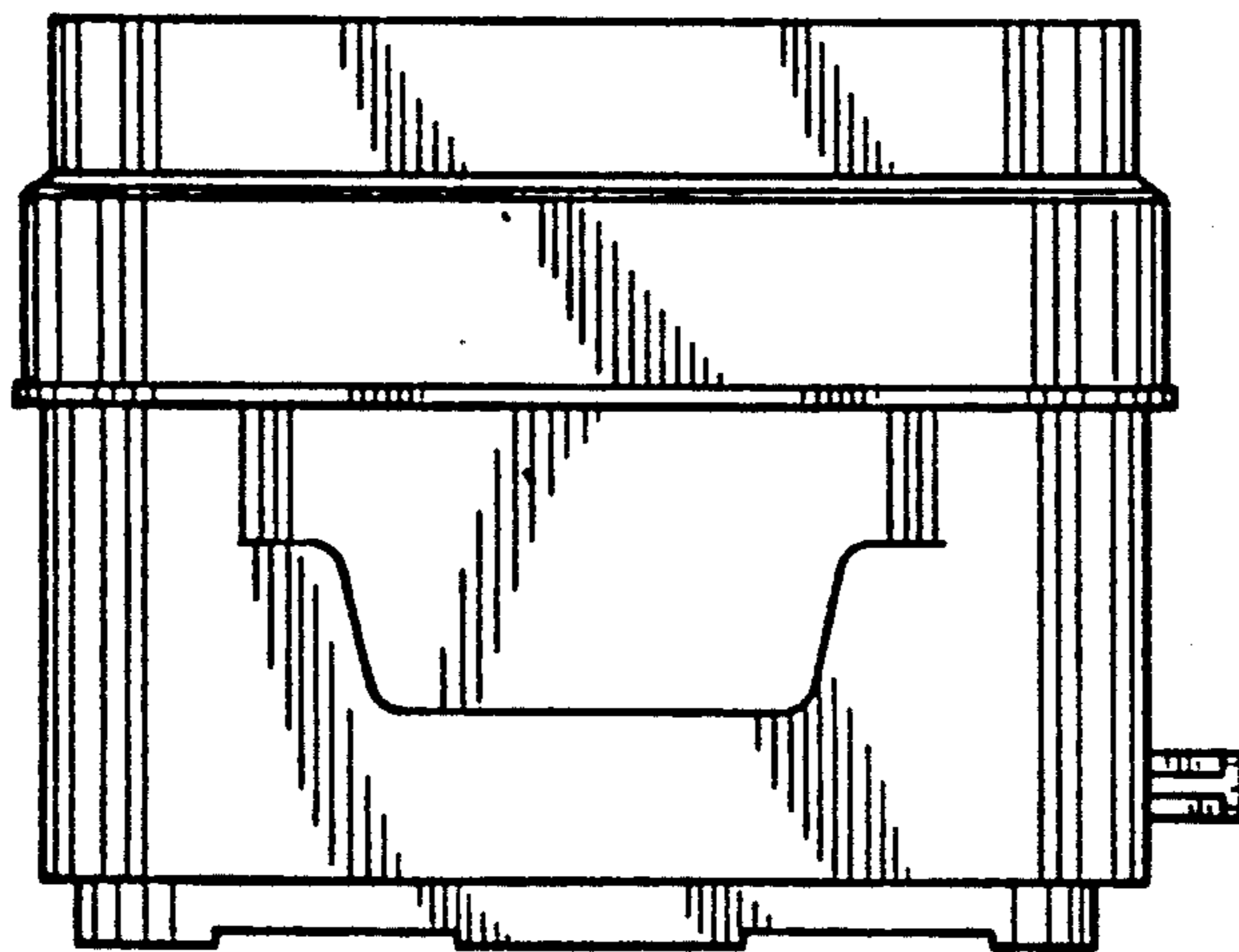

FIG. 10

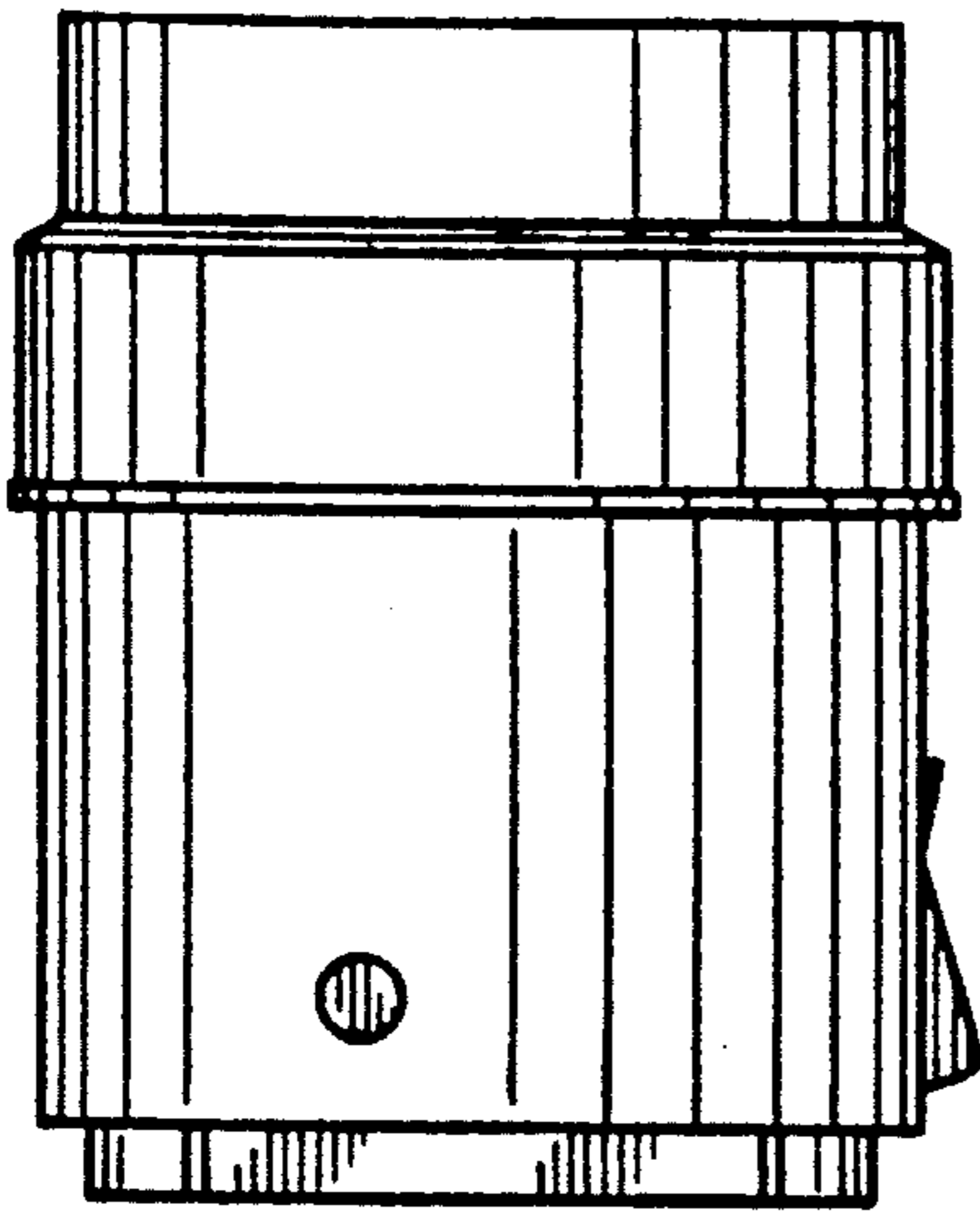

FIG. 11

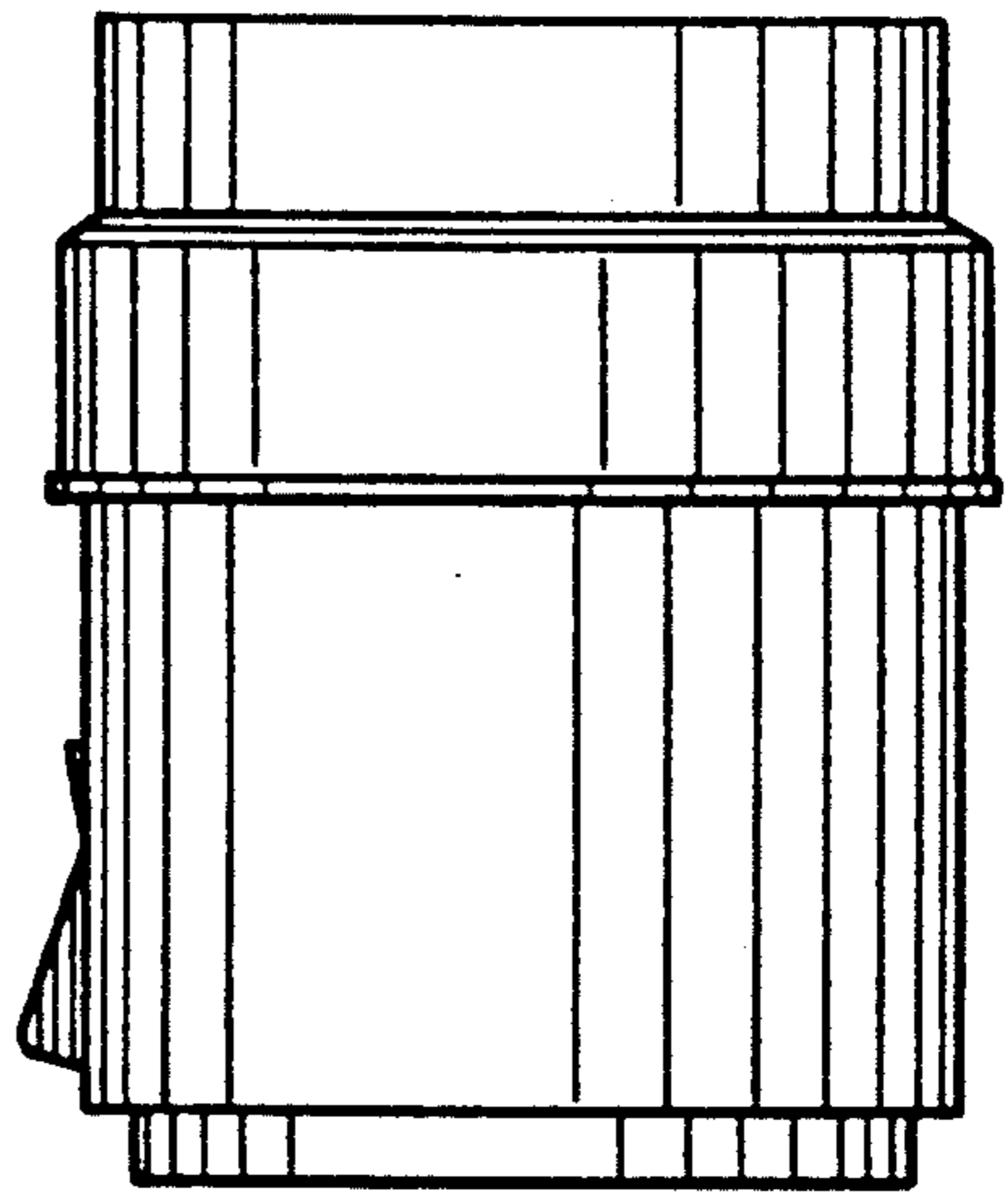

FIG. 12

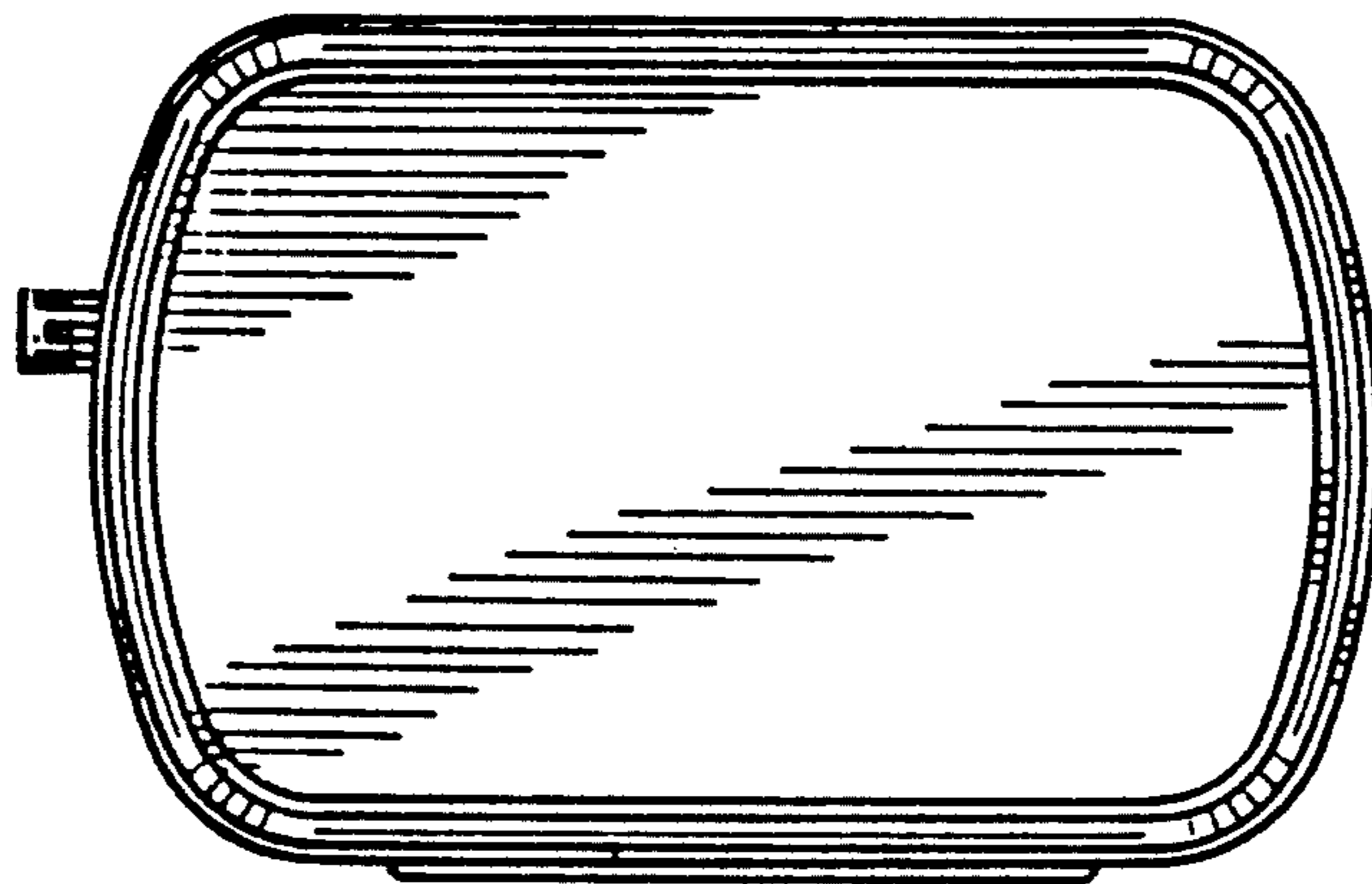

FIG. 13

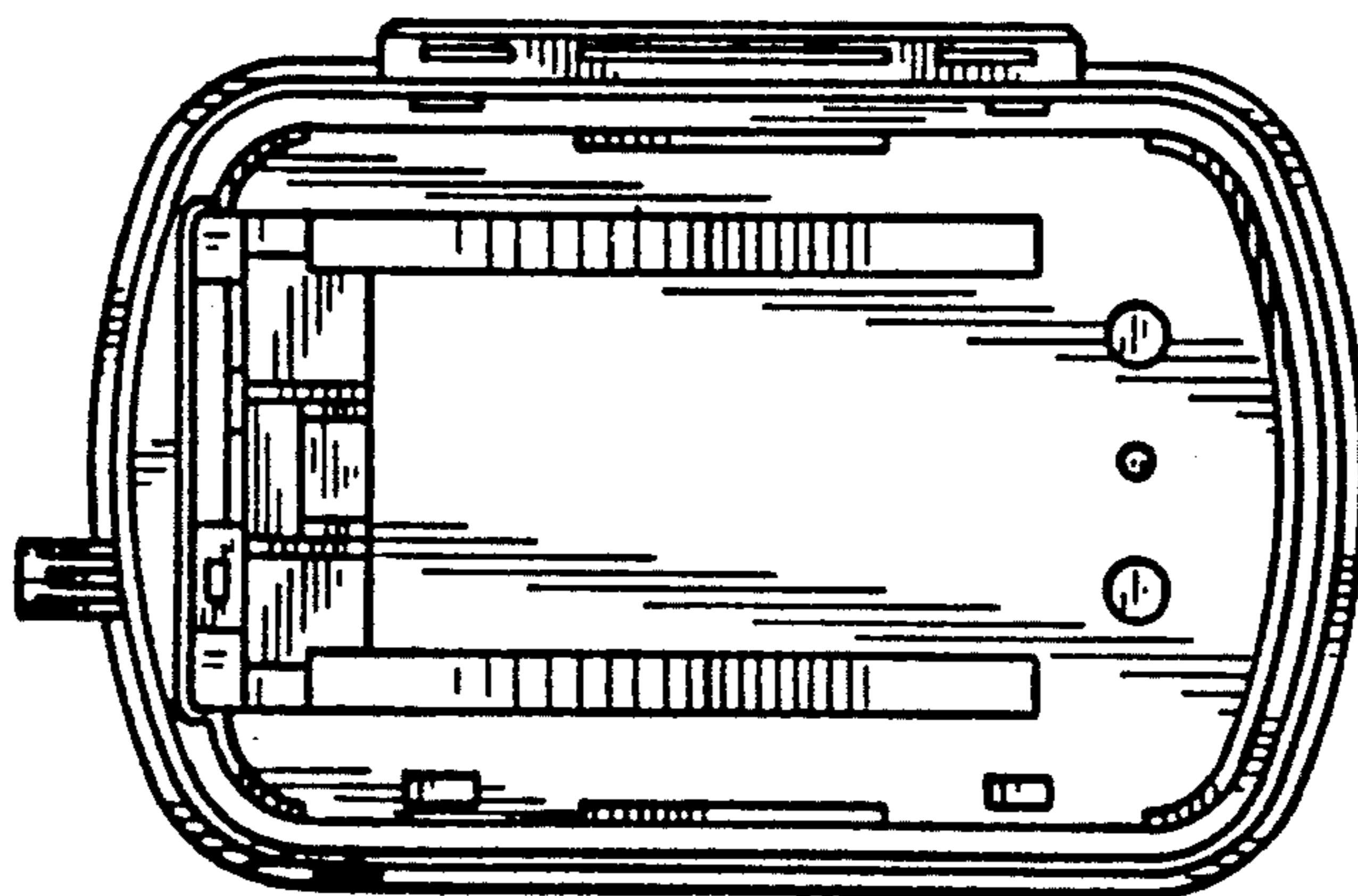

FIG. 14