



US00D331166S

United States Patent [19] Ohadi

[11] Patent Number: **Des. 331,166**

[45] Date of Patent: **** Nov. 24, 1992**

[54] STORAGE UNIT

[75] Inventor: **Farshid P. Ohadi, Chicago, Ill.**

[73] Assignee: **"Z" Rack Storage Systems, Inc., Chicago, Ill.**

[**] Term: **14 Years**

[21] Appl. No.: **905,849**

[22] Filed: **Jun. 26, 1992**

Related U.S. Application Data

[63] Continuation-in-part of Ser. No. 795,652, Nov. 20, 1991.

[52] U.S. Cl. **D6/570; D6/407; D7/616**

[58] Field of Search **D6/407, 552, 567, 569-570; D7/602, 616; 211/40, 49.1, 126, 134; 221/134; 248/235, 247; 312/9.1-9.31**

[56] References Cited

U.S. PATENT DOCUMENTS

D. 132,201	4/1942	Slough	D6/407
D. 160,015	9/1950	Rauch et al.	D6/407
D. 321,291	11/1991	Shoemaker, Jr. et al.	D6/407
D. 325,849	5/1992	Melcher	D7/616
2,238,451	4/1941	Roth	D6/407 X
4,128,175	12/1978	Schweizer	211/40
4,236,768	12/1980	Morrone	211/40 X
4,678,245	7/1987	Fouassier	312/9.22
5,025,936	6/1991	Lamoureaux	211/74

Primary Examiner—Brian N. Vinson
Attorney, Agent, or Firm—McCaleb, Lucas & Brugman

[57] CLAIM

The ornamental design for a storage unit, as shown and described.

DESCRIPTION

FIG. 1 is a top, front, and right side perspective view of a storage unit showing my new design as embodied in a compact disk storage rack;

FIG. 2 is a front elevational view thereof;

FIG. 3 is a right side elevational view thereof;

FIG. 4 is a rear elevational view thereof;

FIG. 5 is a left side elevational view thereof;

FIG. 6 is a top plan view thereof;

FIG. 7 is a bottom plan view thereof;

FIG. 8 is a top, front, and right side perspective view of a storage unit showing my new design as embodied in a videotape cassette storage rack;

FIG. 9 is a front elevational view thereof;

FIG. 10 is a right side elevational view thereof;

FIG. 11 is a rear elevational view thereof;

FIG. 12 is a left side elevational view thereof;

FIG. 13 is a top plan view thereof;

FIG. 14 is a bottom plan view thereof;

FIG. 15 is a top, front, and left side perspective view of a storage unit showing my new design as embodied in a bottle storage rack;

FIG. 16 is a front elevational view thereof;

FIG. 17 is a top plan view thereof;

FIG. 18 is a bottom plan view thereof, with the center portions of the base shown broken away;

FIG. 19 is a right side elevational view thereof;

FIG. 20 is a left side elevational view thereof; and,

FIG. 21 is a rear elevational view thereof.

The portions of wall, compact disk, videotape and bottles in the views are for illustrative purposes only and form no part of the claimed design.

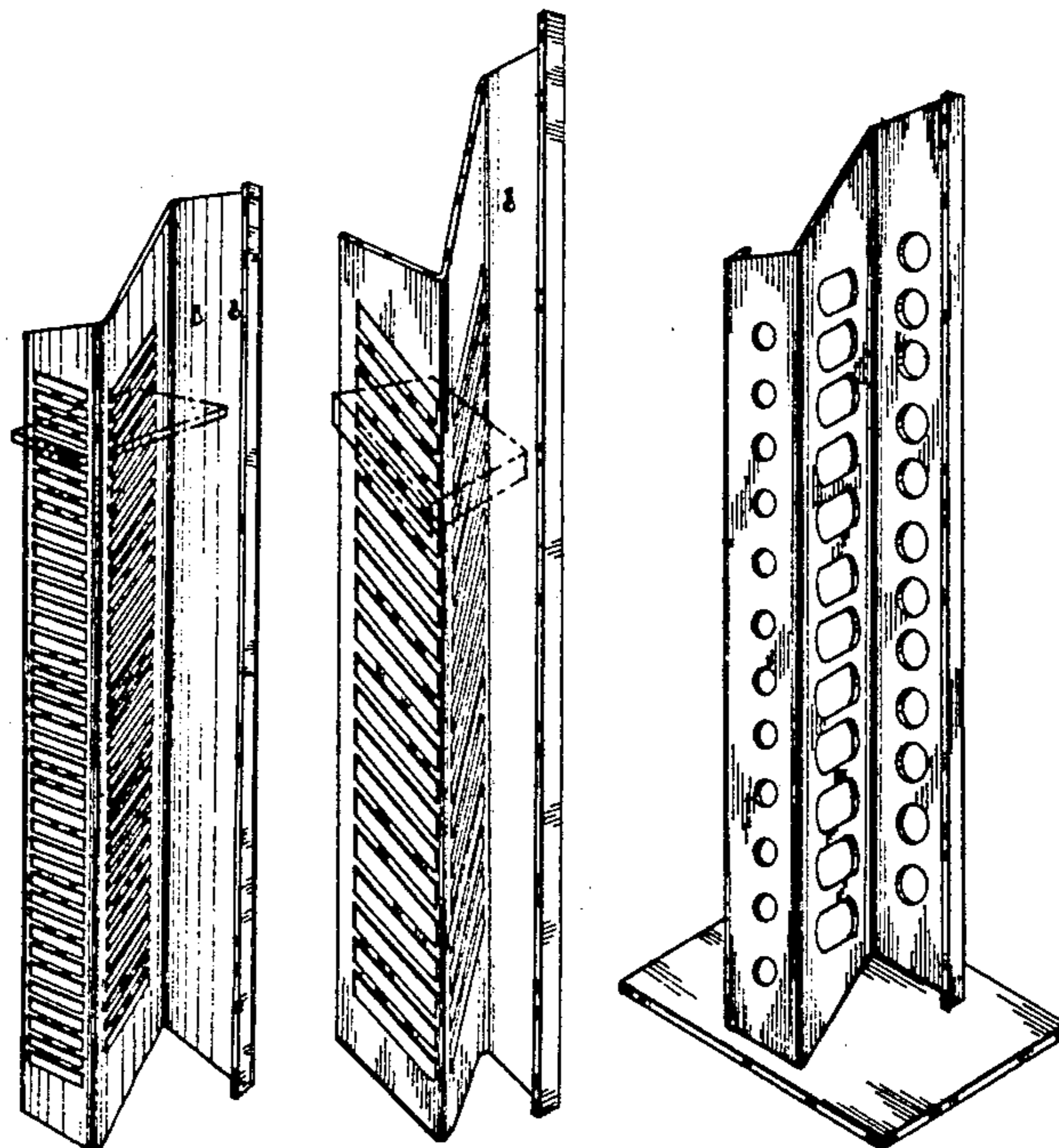

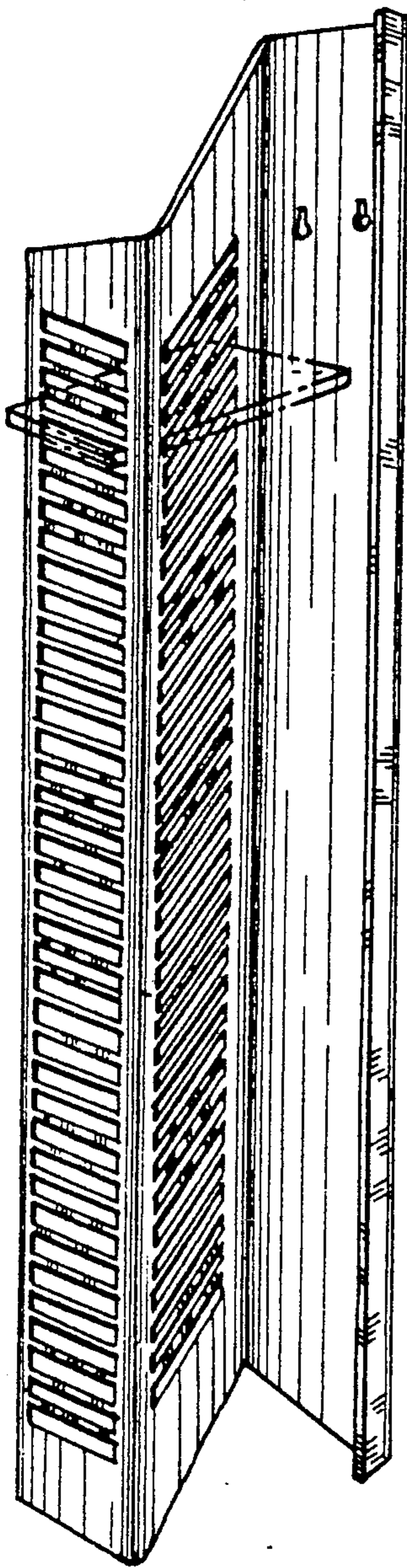

FIG. 1

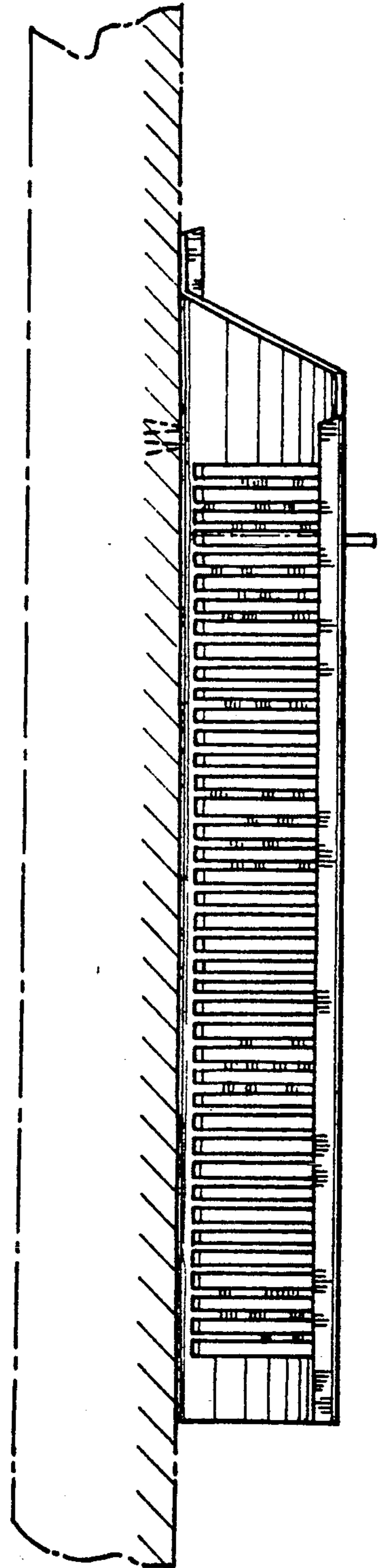

FIG. 5

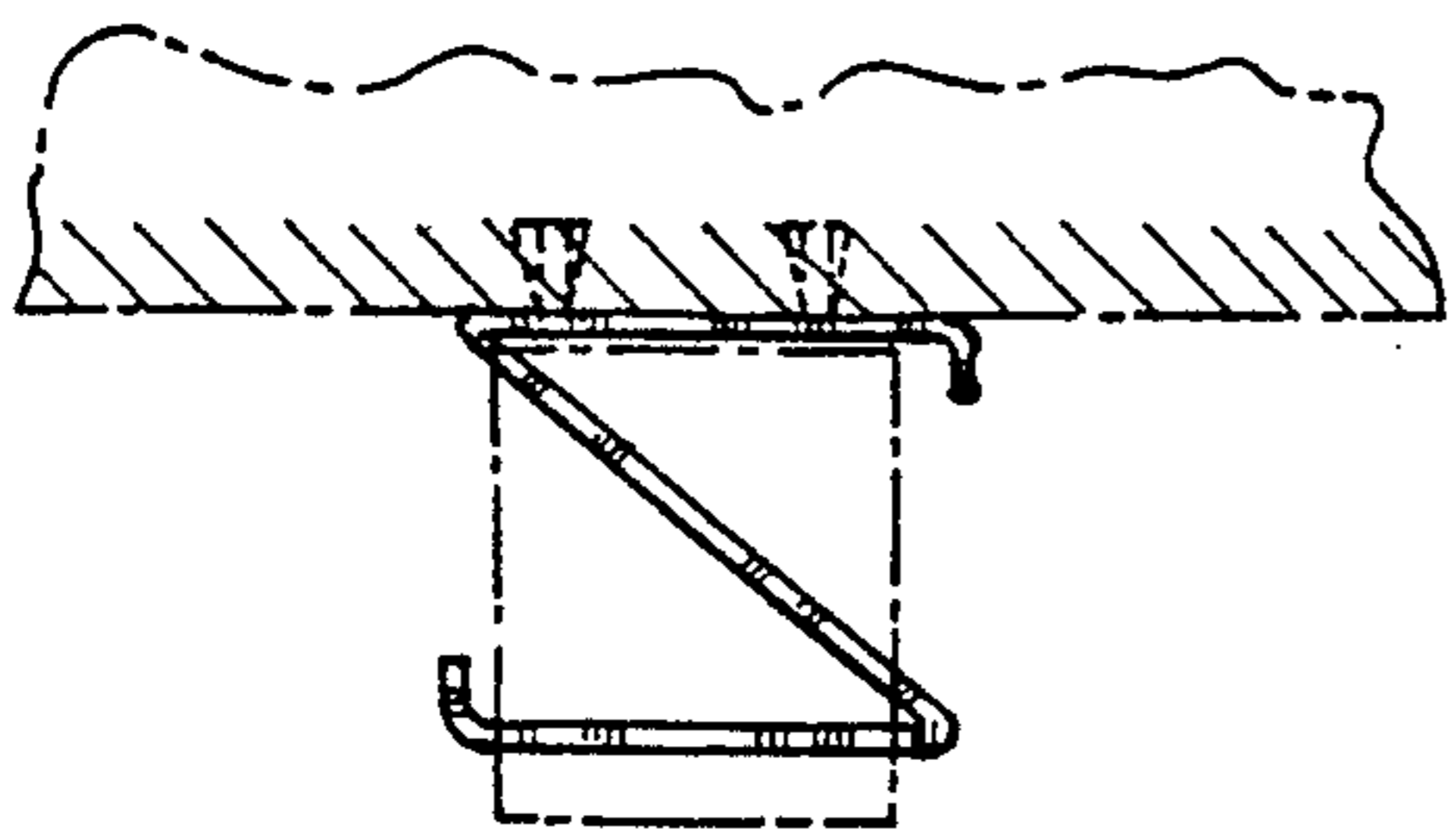

FIG. 6

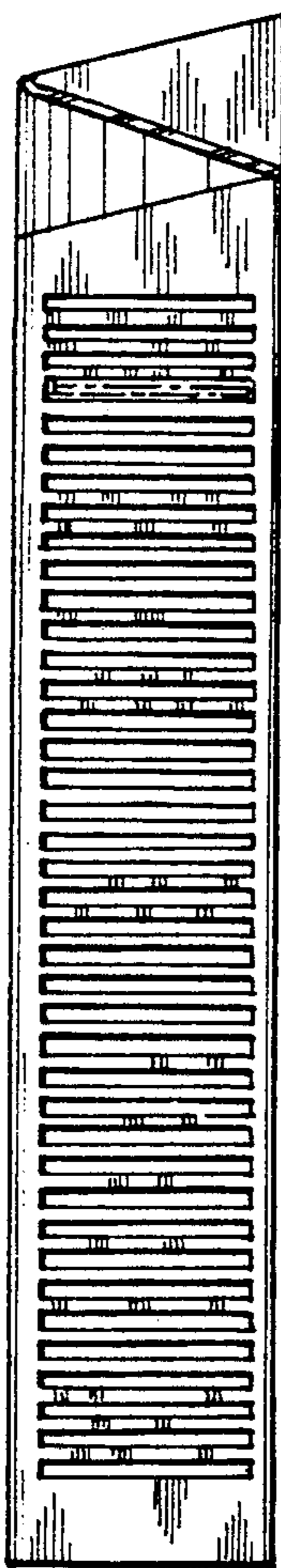

FIG. 2

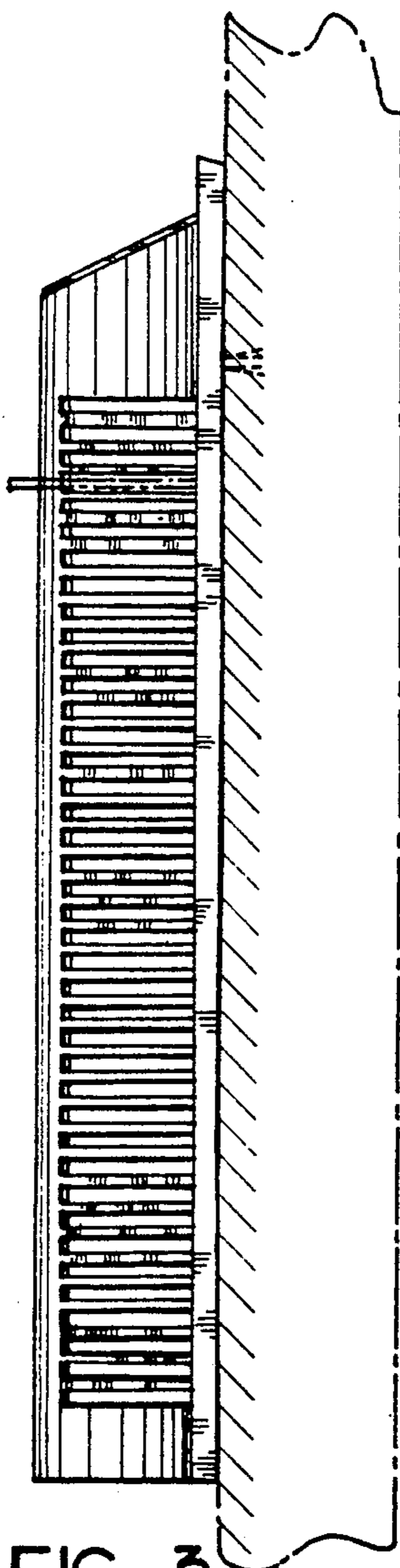

FIG. 3

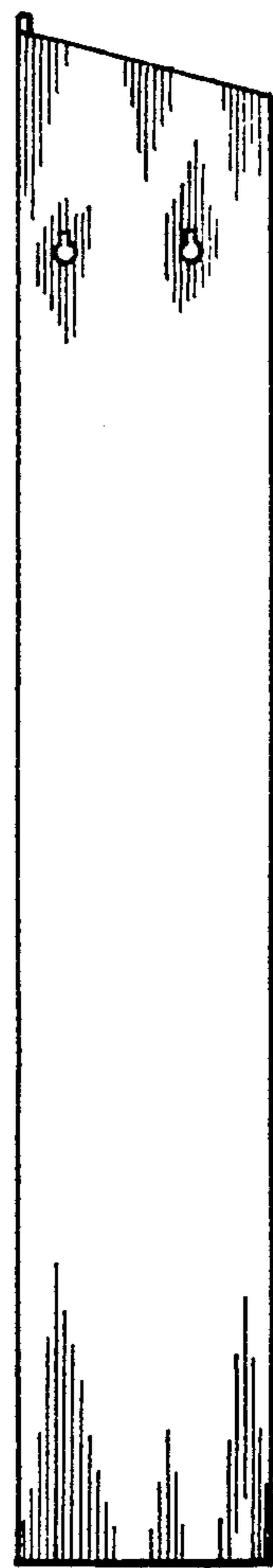

FIG. 4

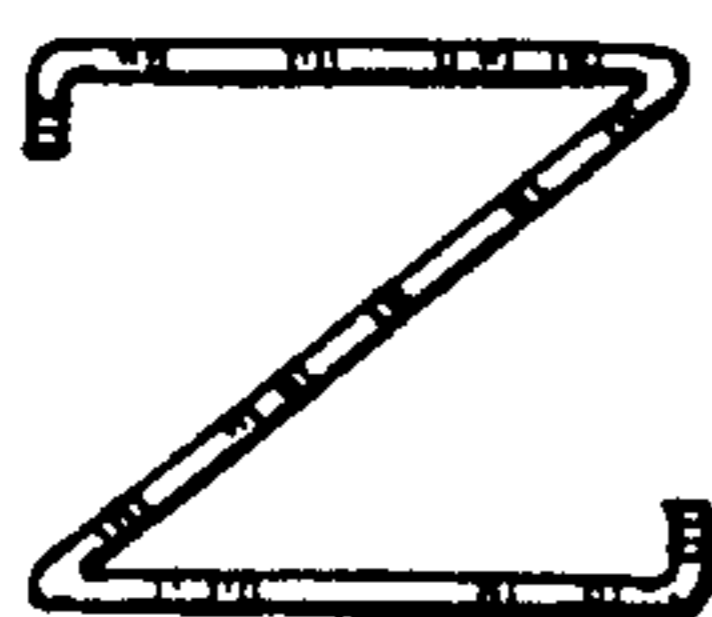

FIG. 7

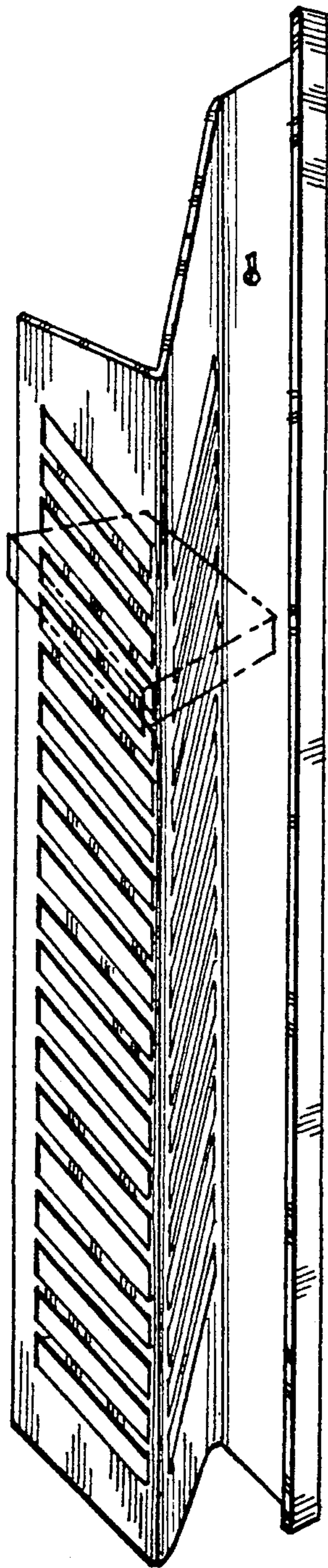

FIG. 8

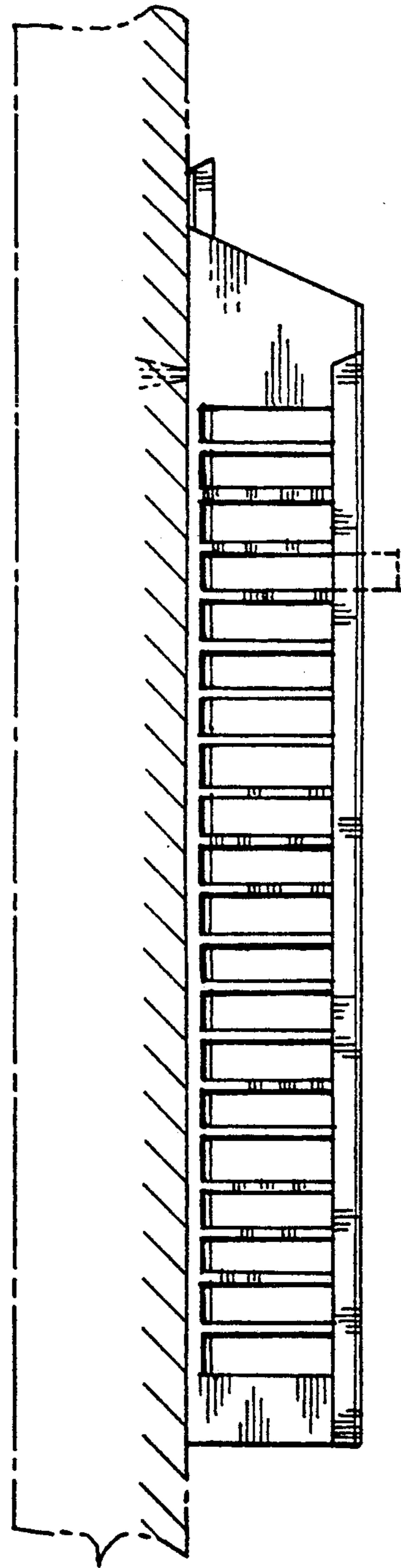

FIG. 12

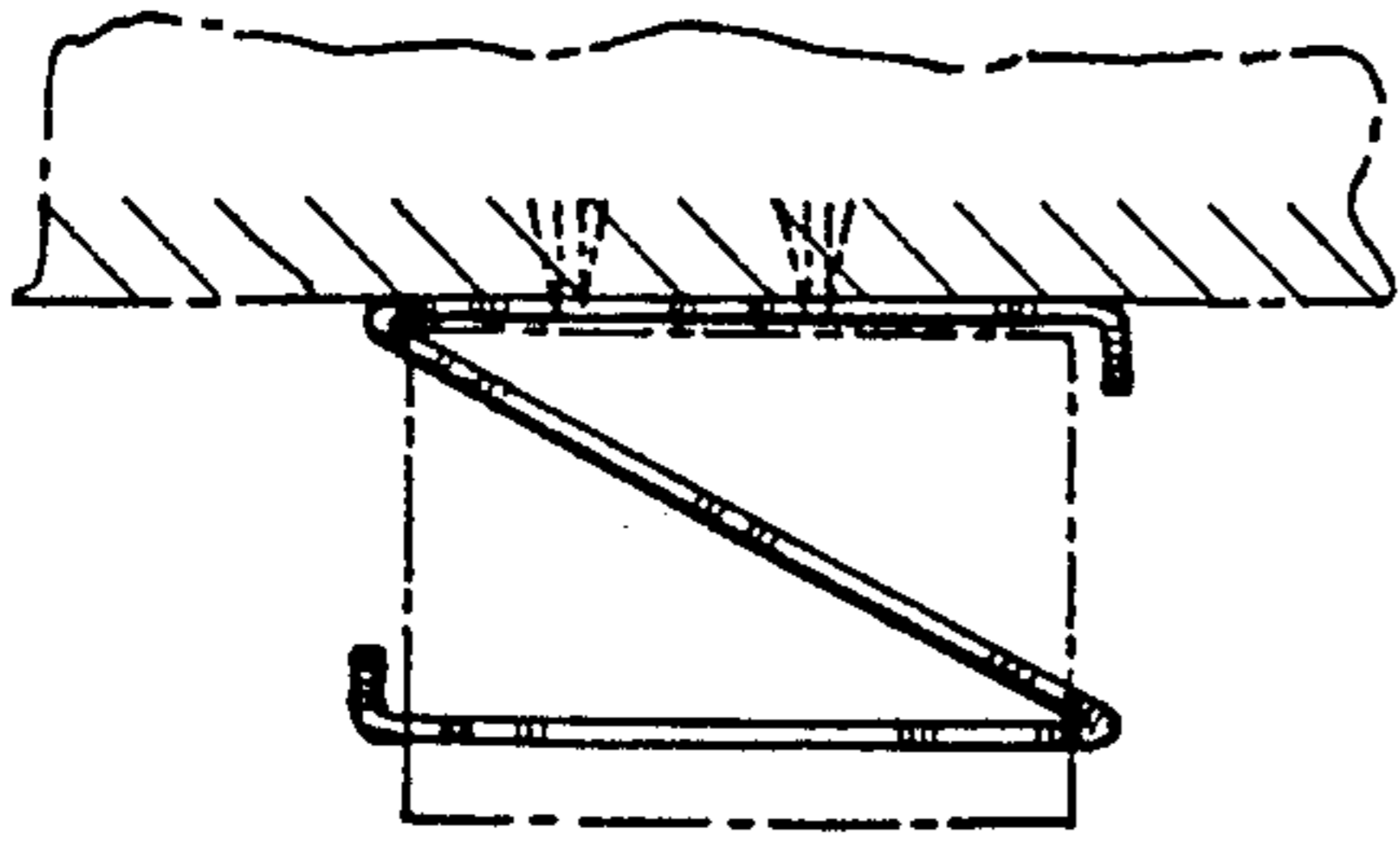

FIG. 13

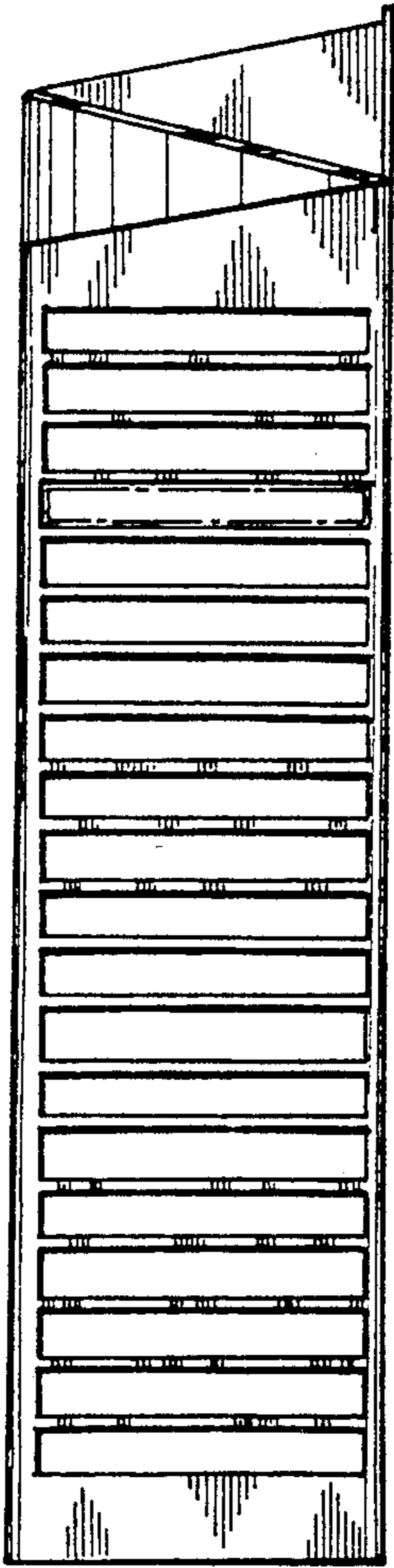

FIG. 9

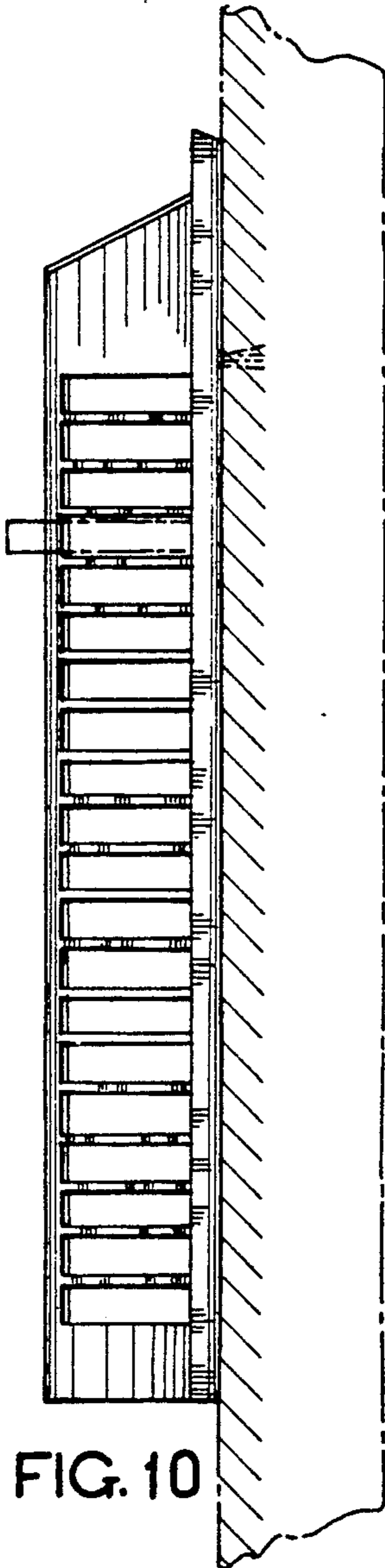

FIG. 10

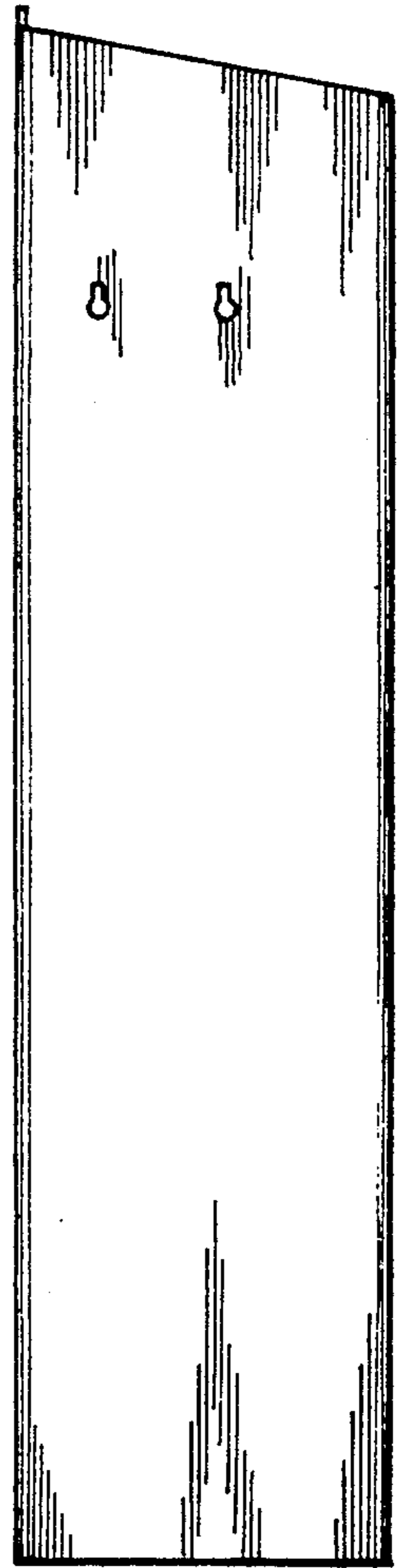

FIG. 11

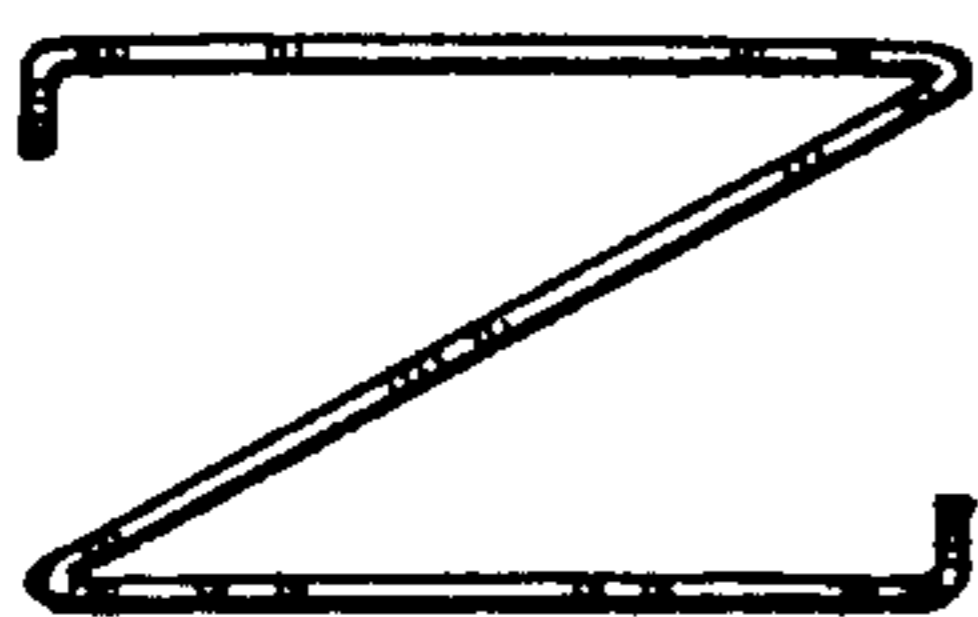

FIG. 14

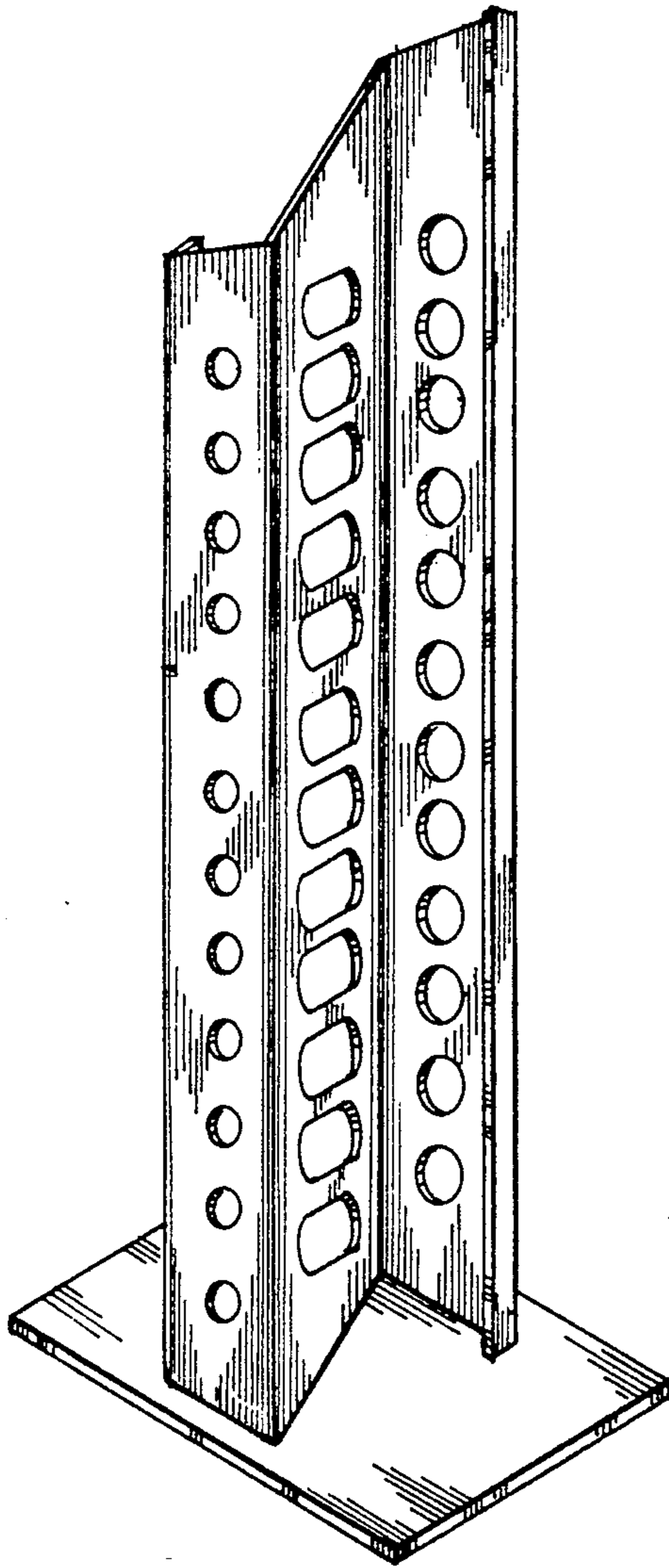

FIG. 15

FIG. 17

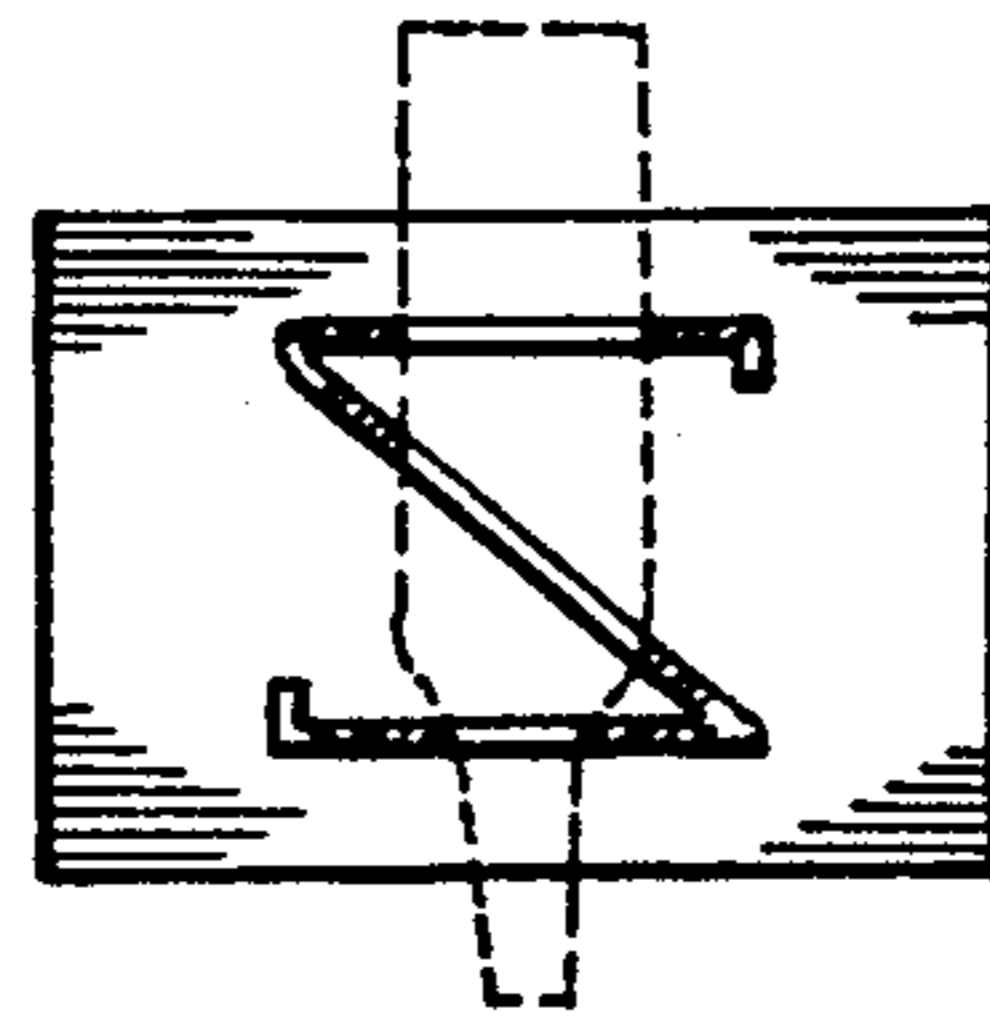

FIG. 16

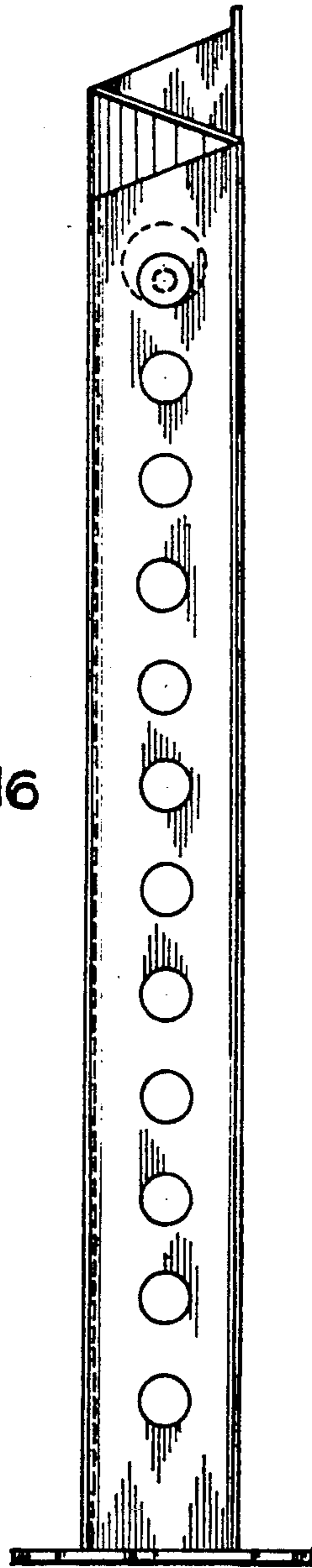
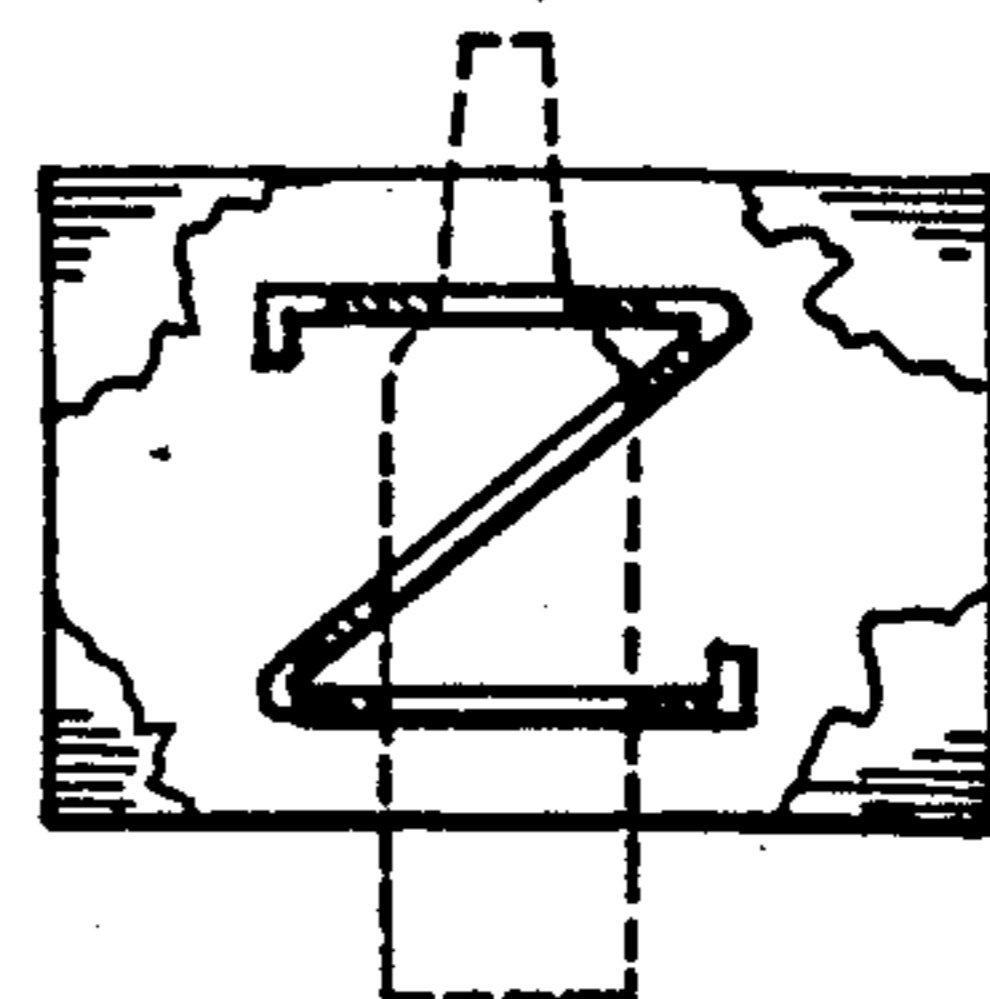

FIG. 18



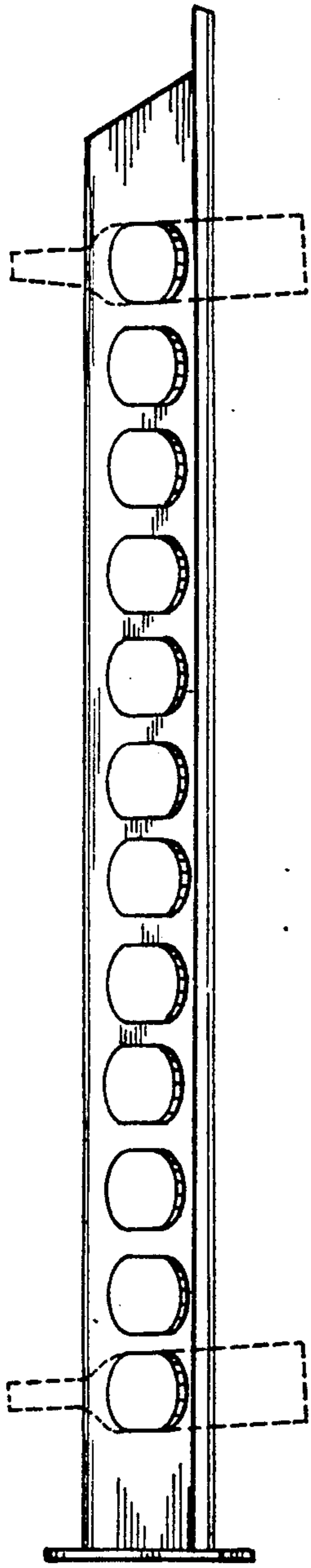

FIG. 19

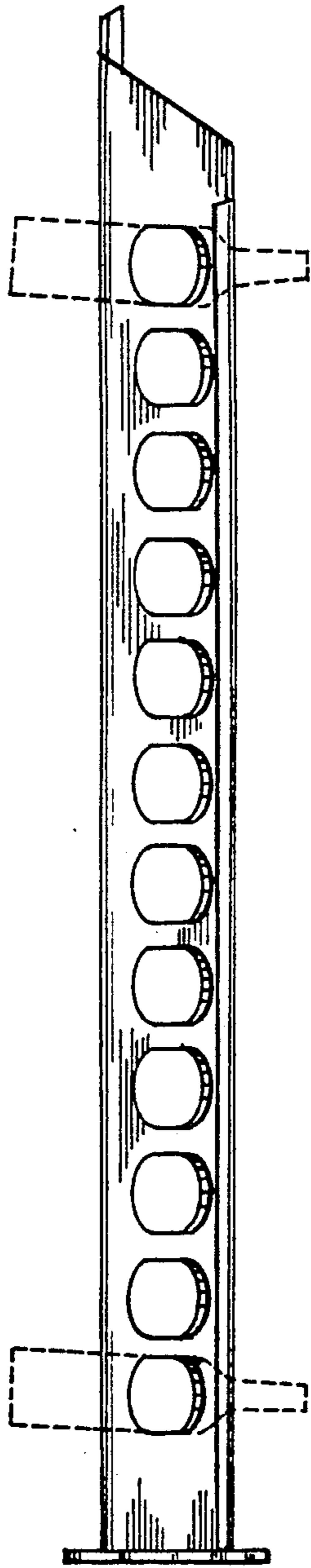

FIG. 20

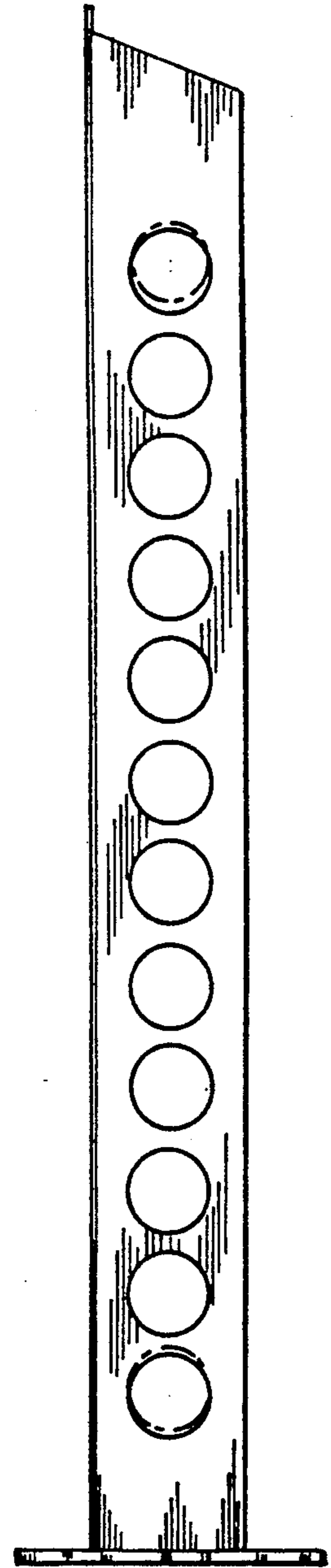

FIG. 21