



US00D331136S

United States Patent [19]

[11] Patent Number: **Des. 331,136**

Davis et al.

[45] Date of Patent: **** Nov. 17, 1992**

[54] **COMPARTMENTED SHOPPING CART**

2,662,661	12/1953	Goldman	280/33.991
3,361,438	1/1968	Davis	280/33.991
3,534,973	10/1970	Elliott	280/33.991

[76] Inventors: **Adrian Davis**, 6032 Quiet Cove Ct., Charlotte, N.C. 28215; **Hattie A. Goff**, 1209 Worcaster Pl., Charlotte, N.C. 28211

Primary Examiner—Kay H. Chin
Attorney, Agent, or Firm—Terry M. Gernstein

[**] Term: **14 Years**

[57] **CLAIM**

[21] Appl. No.: **550,360**

The ornamental design for a compartmented shopping cart, as shown and described.

[22] Filed: **Jul. 10, 1990**

DESCRIPTION

[52] U.S. Cl. **D34/20; D34/19**

[58] Field of Search **D34/12, 17, 18, 19, D34/20, 23; 280/47.26, 79.3, 47.19**

FIG. 1 is a perspective view of a compartmented shopping cart showing our new design; FIG. 2 is a rear elevational view thereof; FIG. 3 is a front elevational view thereof; FIG. 4 is a right side elevational view thereof; FIG. 5 is a left side elevational view thereof; FIG. 6 is a top plan view thereof; and, FIG. 7 is a bottom plan view thereof.

[56] **References Cited**

U.S. PATENT DOCUMENTS

D. 311,082 10/1990 Nordstrom et al. D34/26

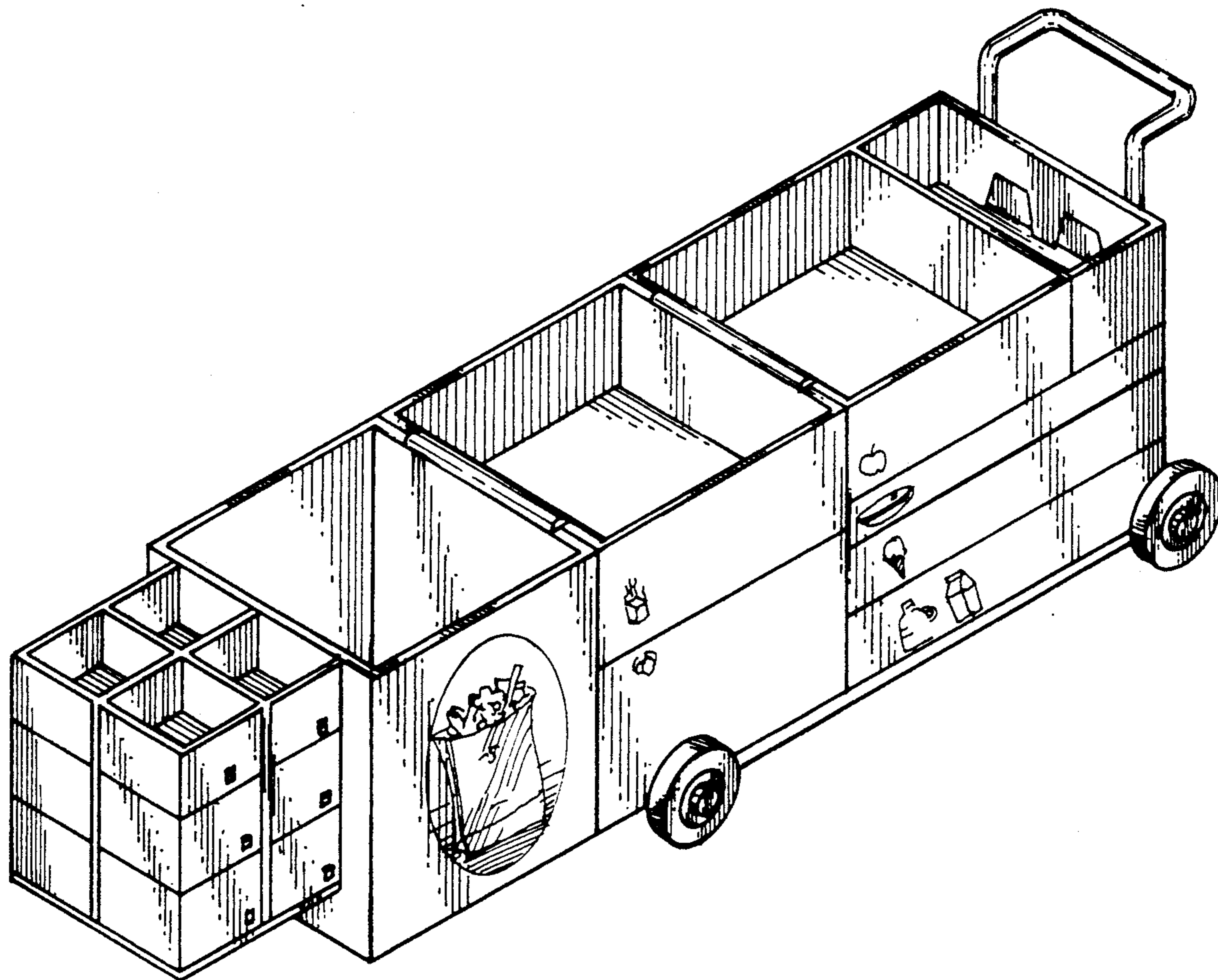

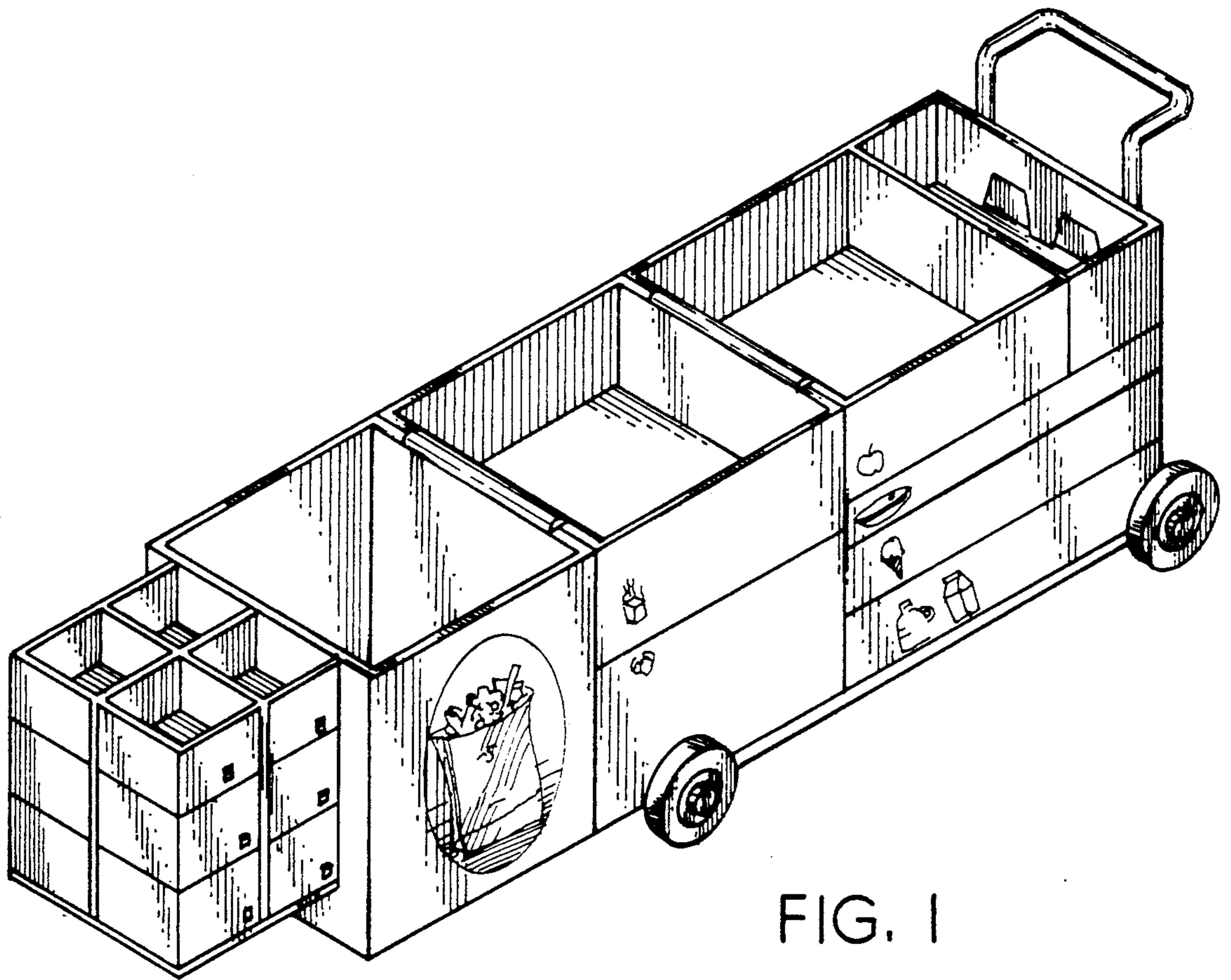

FIG. 1

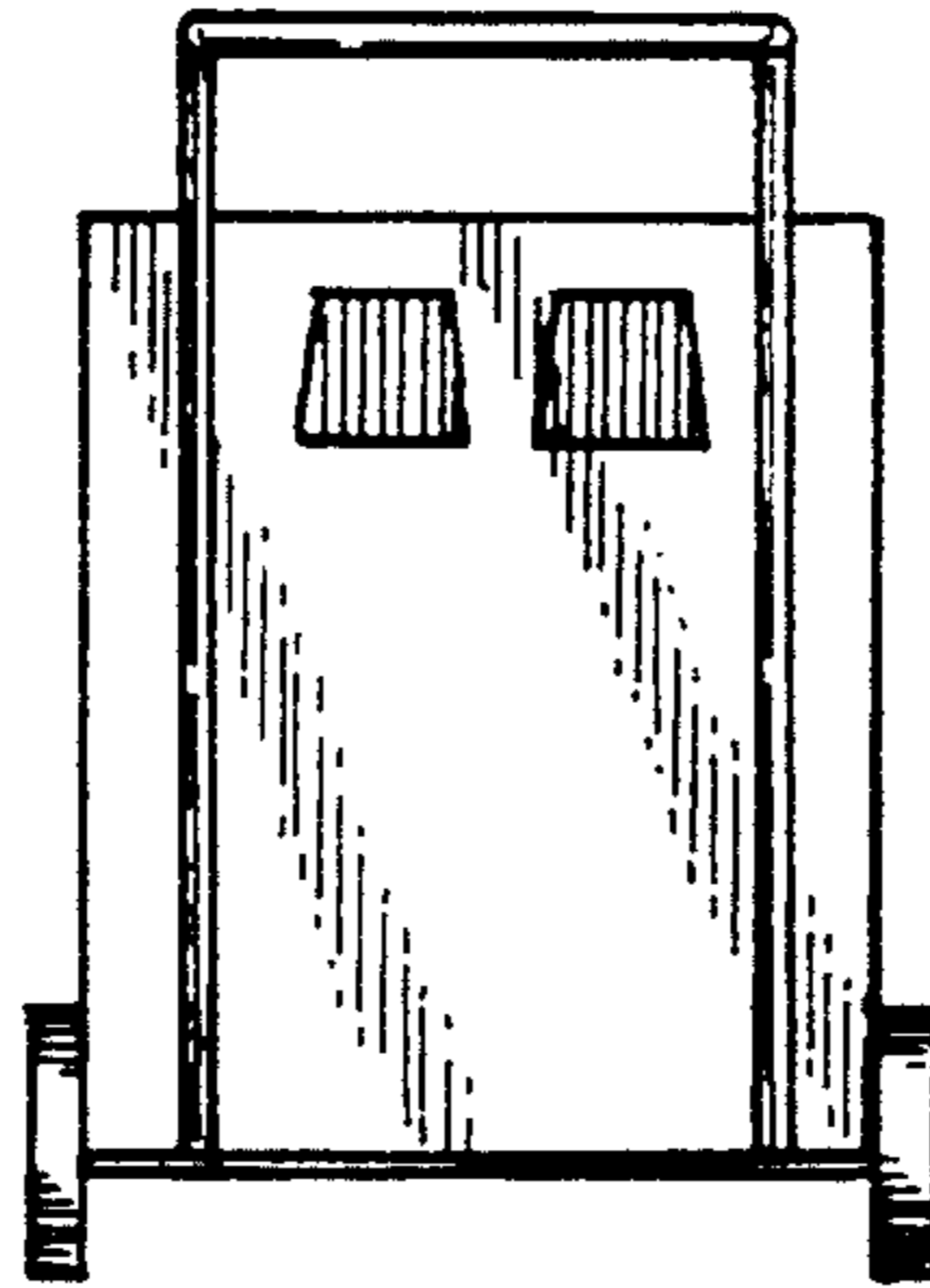

FIG. 2

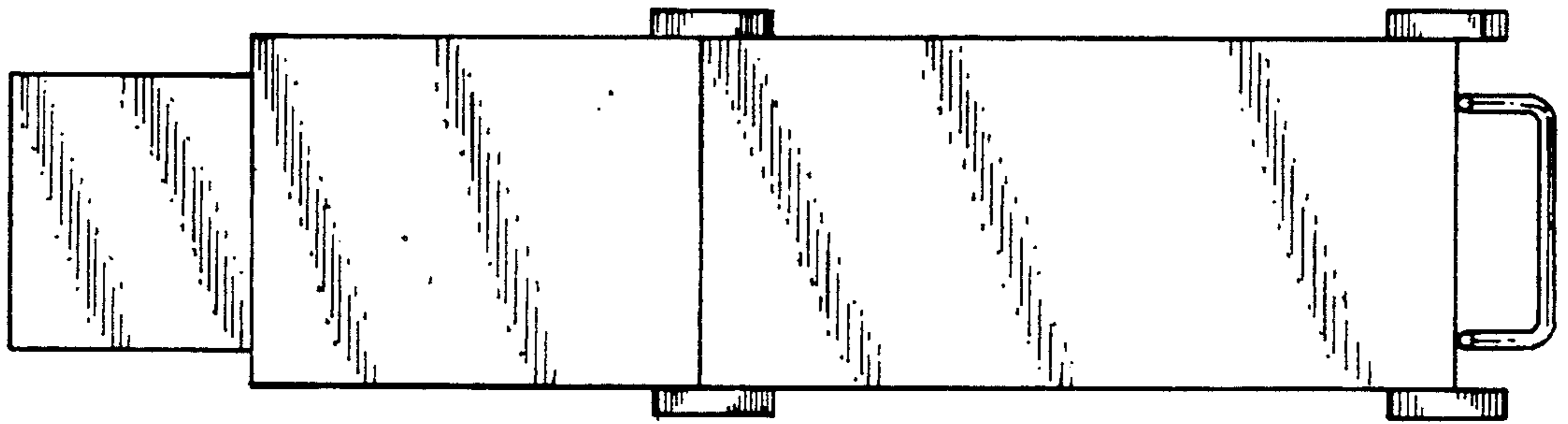

FIG. 7

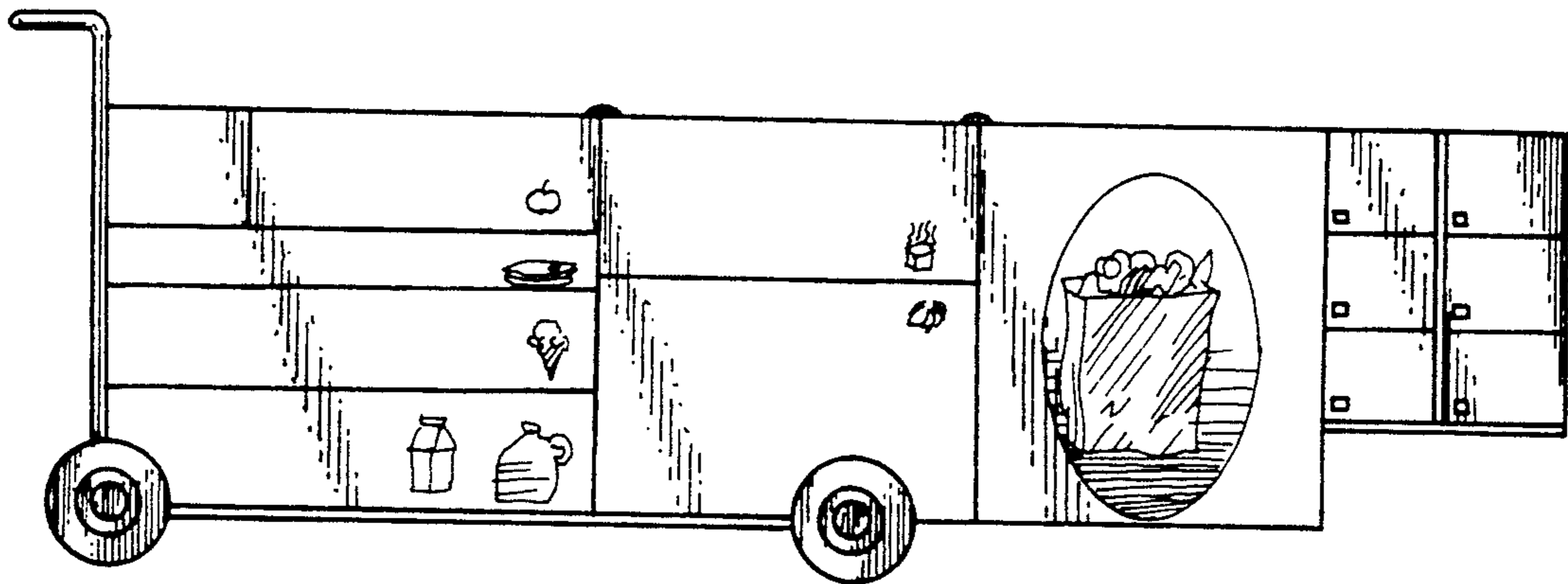

FIG. 4

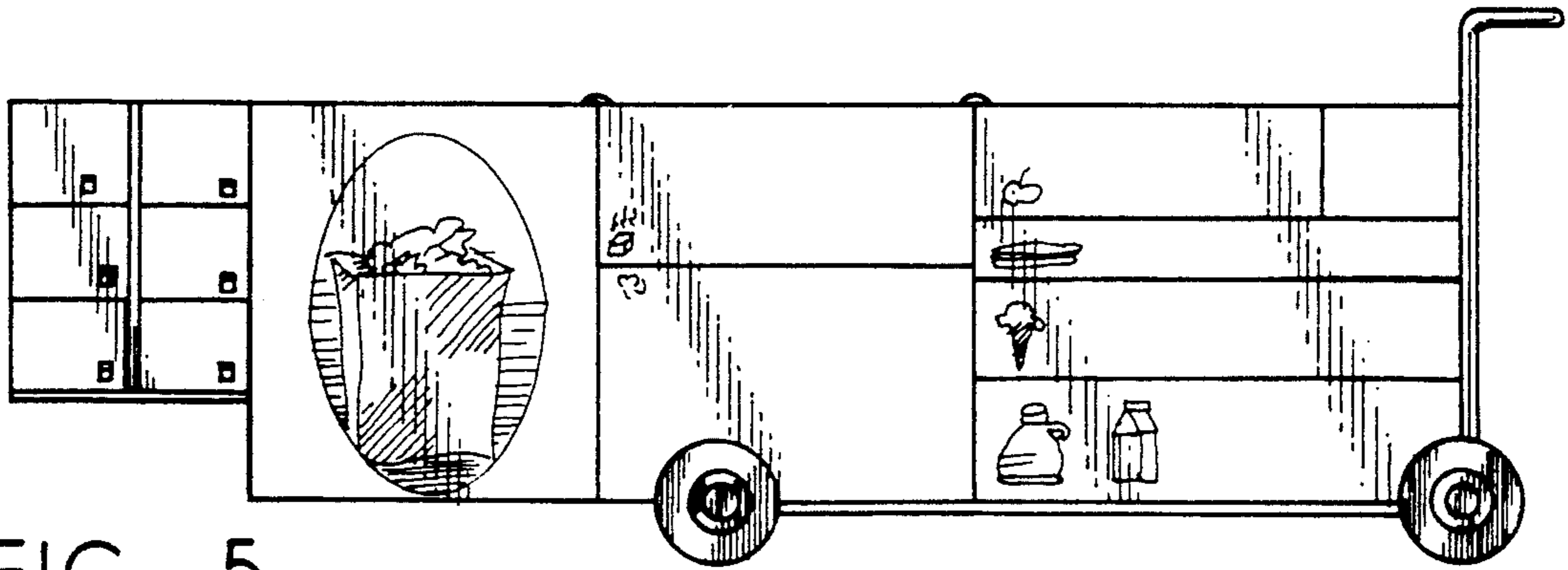

FIG. 5

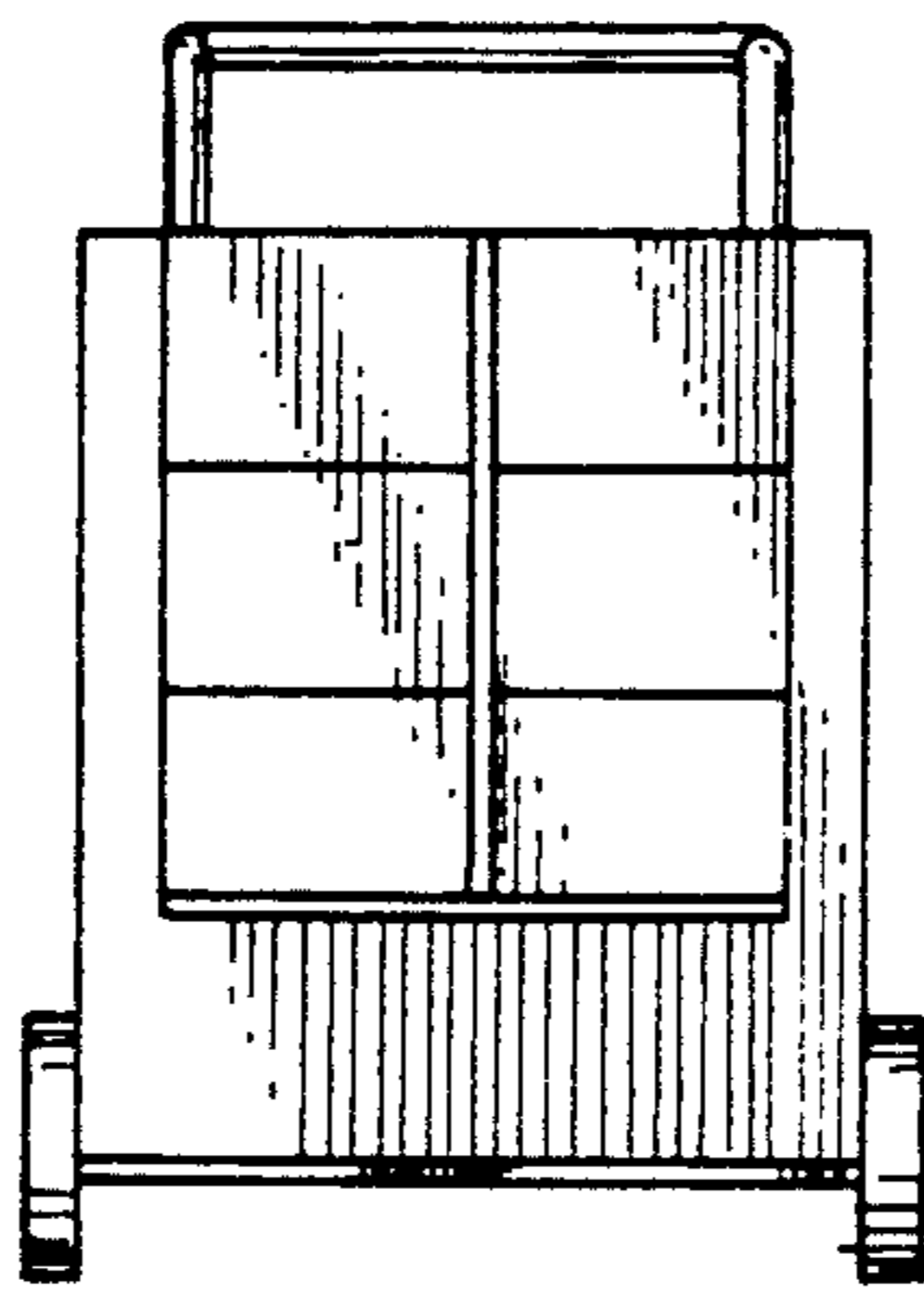

FIG. 3

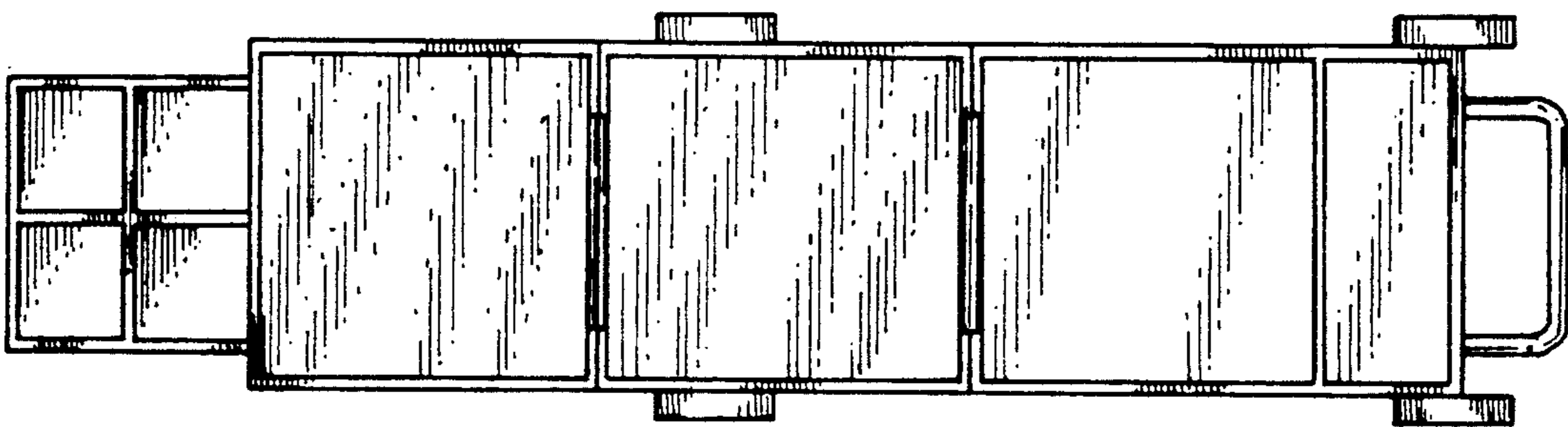

FIG. 6