



US00D331001S

United States Patent [19]

[11] Patent Number: **Des. 331,001**

Hu Huang

[45] Date of Patent: **** Nov. 17, 1992**

[54] STAPLER

D. 318,609 7/1991 Sato D8/49
2,726,393 12/1955 Vogel 227/128

[75] Inventor: **Li-Chen Hu Huang, Taipei, Taiwan**

Primary Examiner—Bernard Ansher

[73] Assignee: **Pro Eton Corporation, Taiwan**

Assistant Examiner—R. Barkai

[**] Term: **14 Years**

Attorney, Agent, or Firm—Wenderoth, Lind & Ponack

[21] Appl. No.: **599,353**

[57] **CLAIM**

The ornamental design for a stapler, as shown and described.

[22] Filed: **Oct. 5, 1990**

[52] U.S. Cl. **D8/50**

[58] Field of Search D8/49, 50; 227/120,
227/127, 128, 131, 155

DESCRIPTION

FIG. 1 is a perspective view of the stapler of my new design in a closed condition;

FIG. 2 is a perspective view of the stapler of my new design in an open condition;

FIG. 3 is a left side elevational view thereof;

FIG. 4 is a right side elevational view thereof;

FIG. 5 is a front elevational view thereof;

FIG. 6 is a rear elevational view thereof;

FIG. 7 is a top plan view thereof; and,

FIG. 8 is a bottom plan view thereof.

[56] **References Cited**

U.S. PATENT DOCUMENTS

D. 180,445	6/1957	Fenon	D8/50
D. 186,201	9/1959	Rosengren	D8/50
D. 301,677	7/1987	Rosenblad	D8/50
D. 302,781	8/1989	Ebihara	D8/50
D. 304,902	12/1989	Ebihara	D8/50

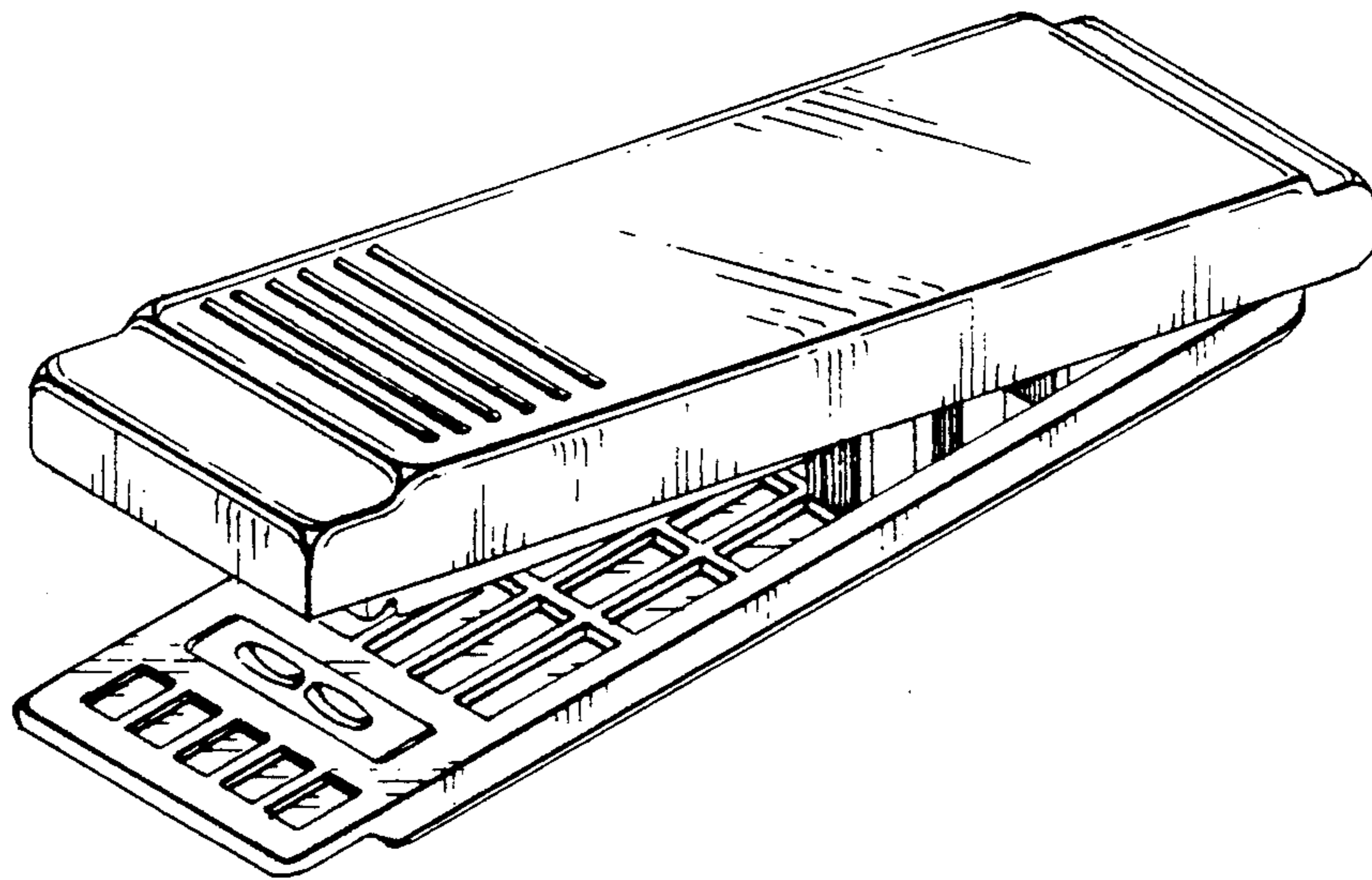

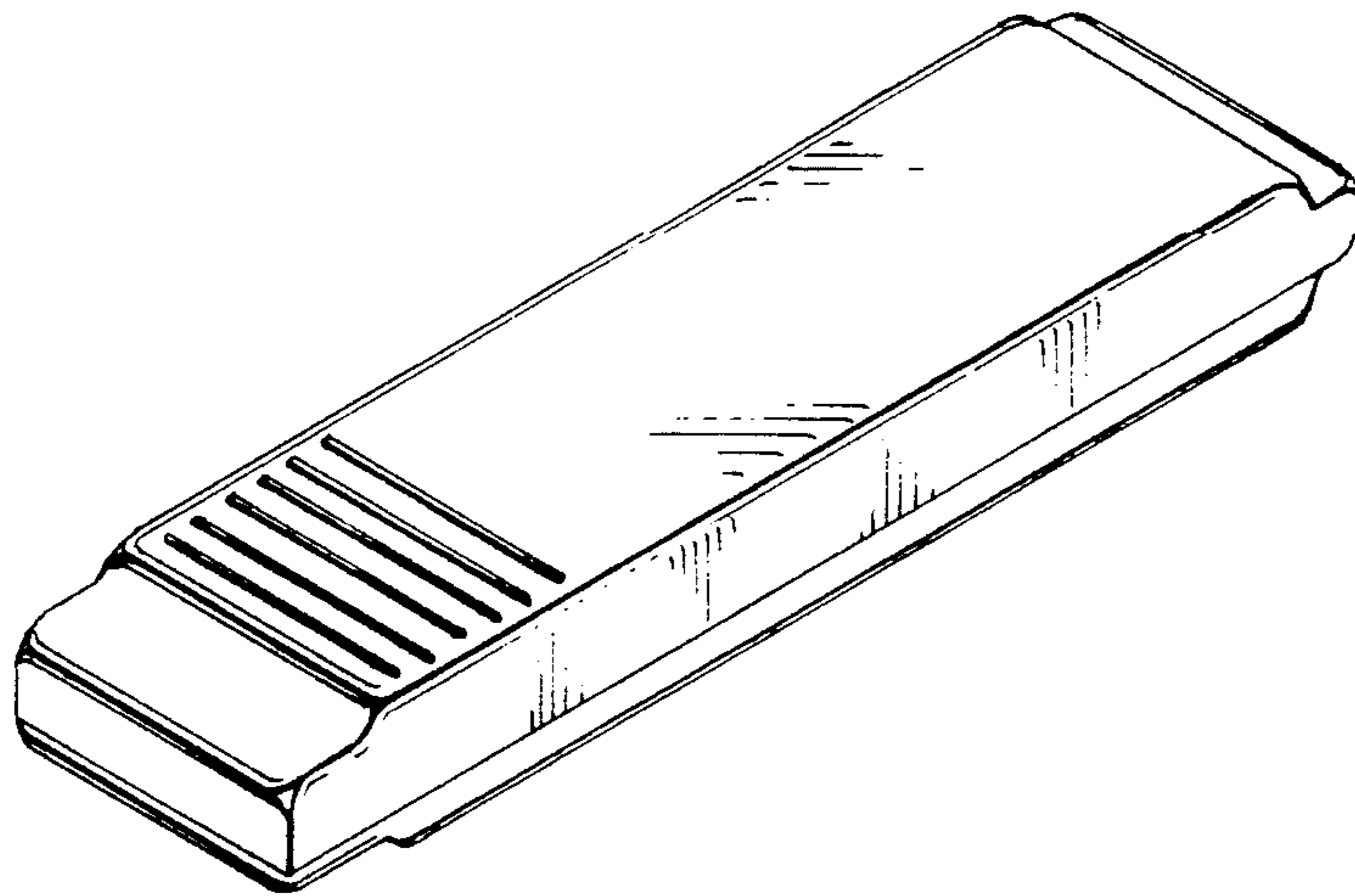

FIG. 1

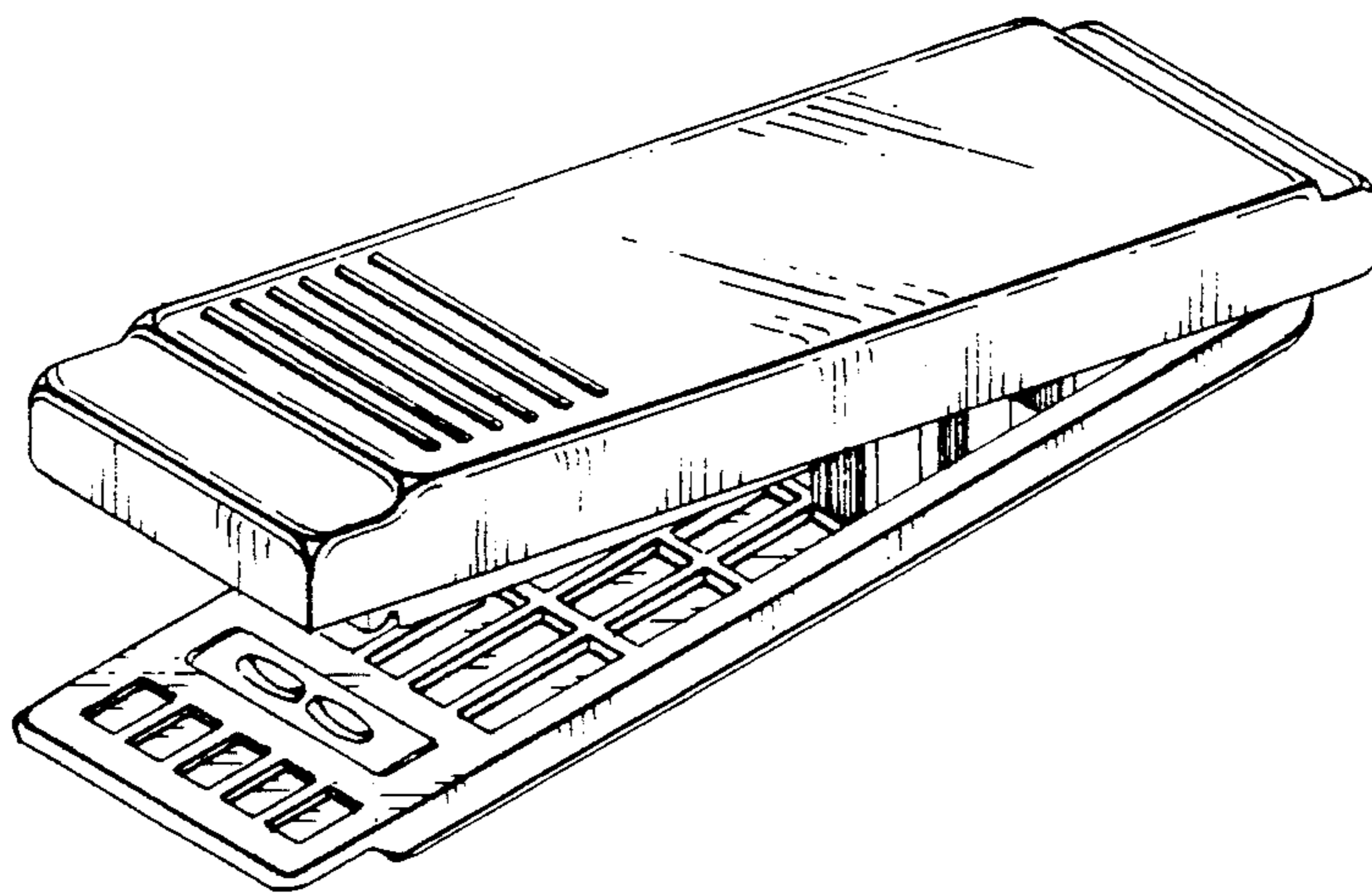

FIG. 2

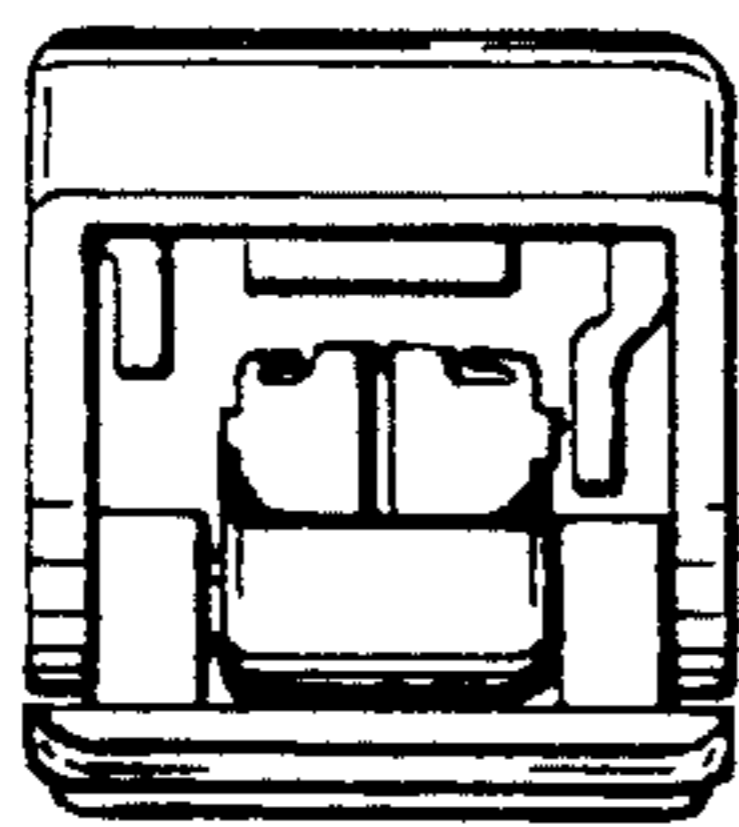

FIG. 3

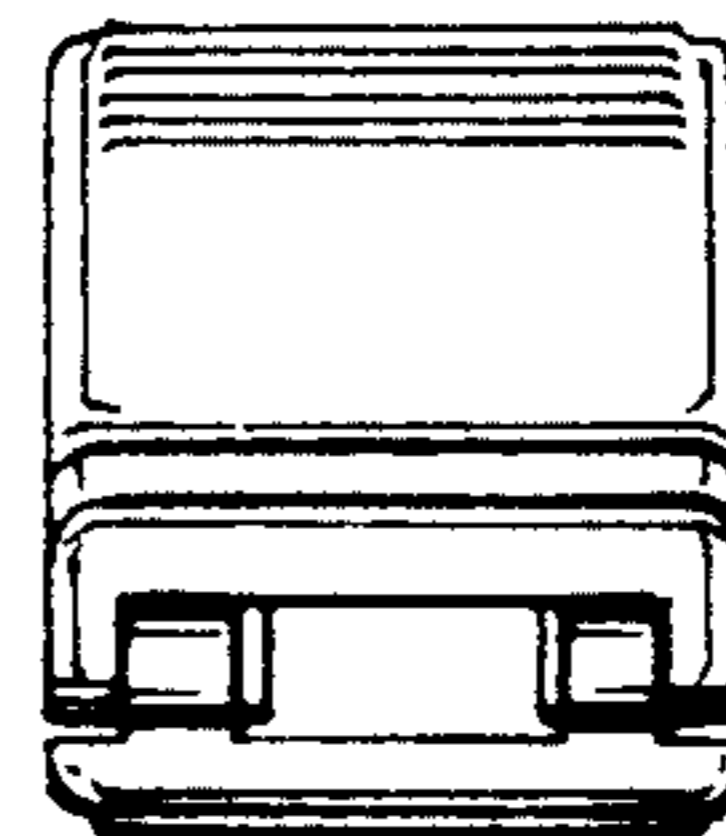

FIG. 4

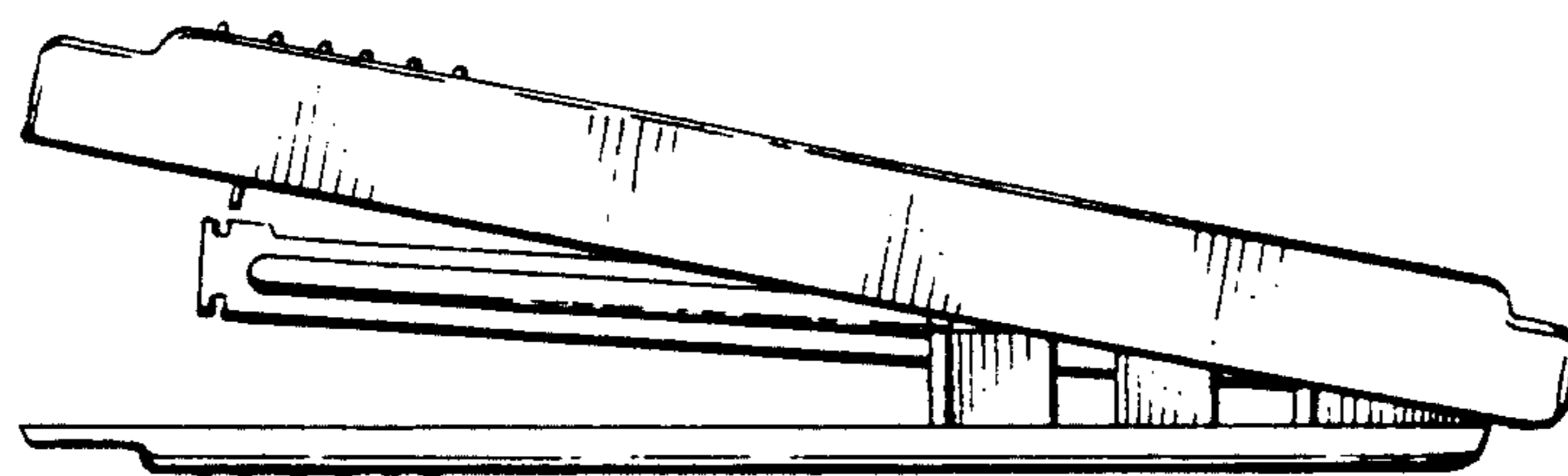

FIG. 5

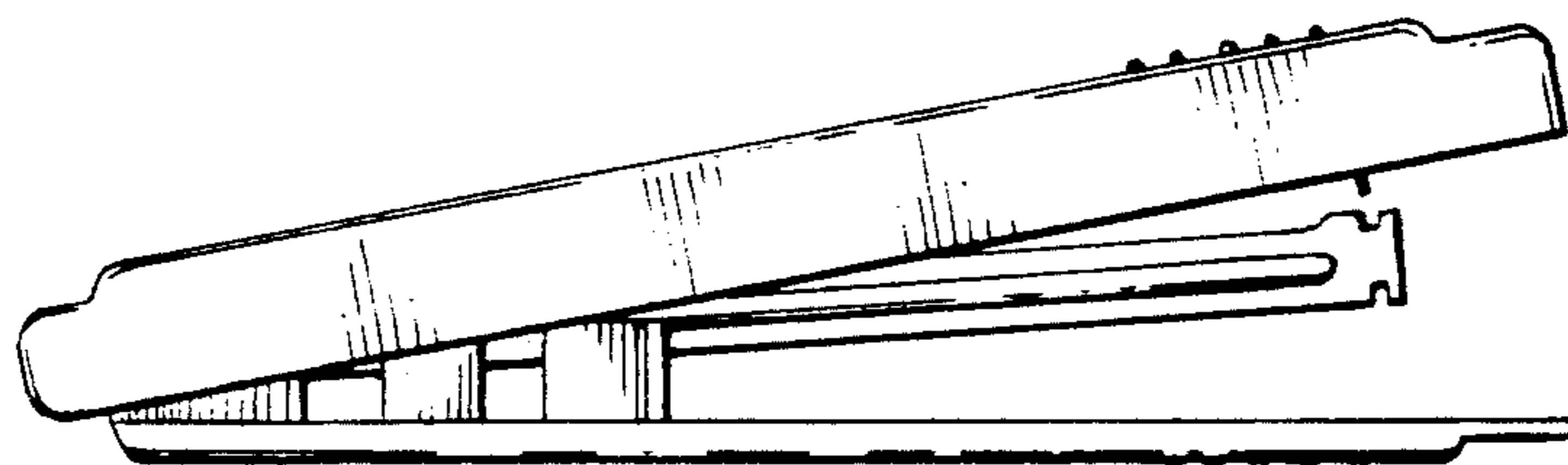

FIG. 6

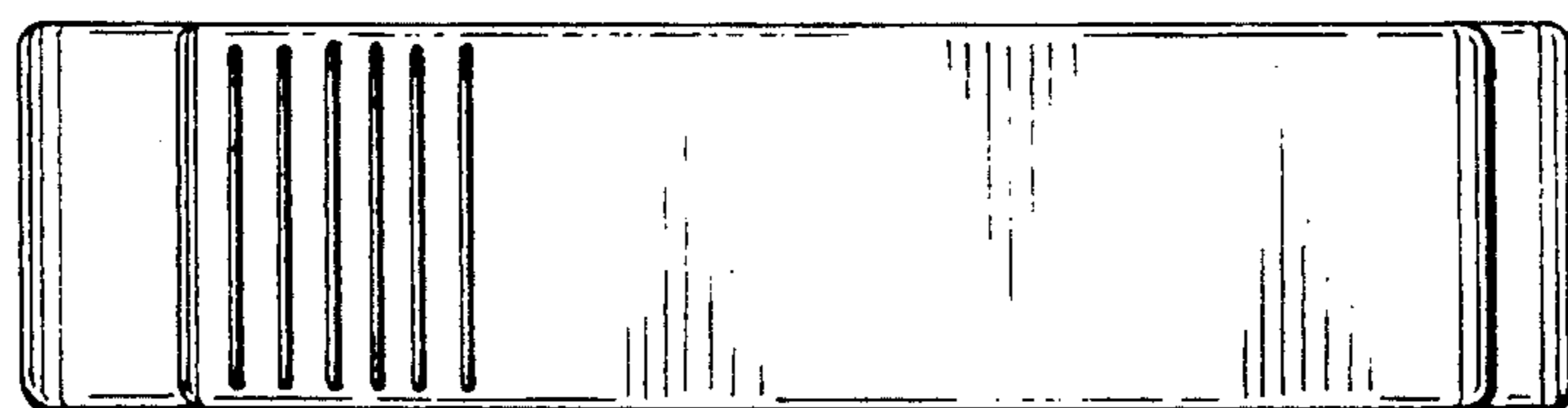

FIG. 7

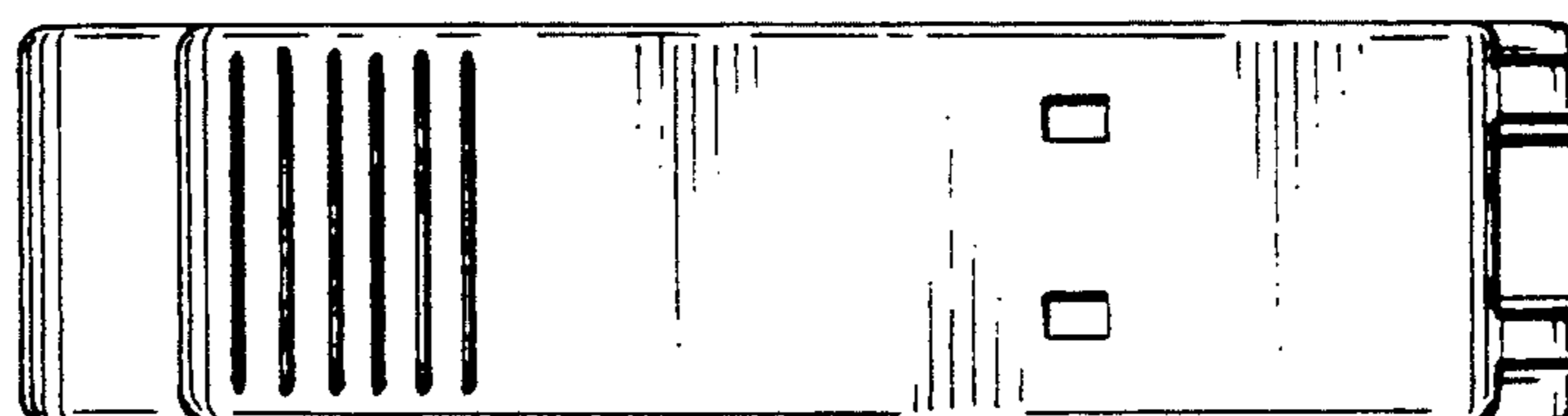

FIG. 8