



US00D330942S

# United States Patent [19]

[11] Patent Number: **Des. 330,942**

Leung

[45] Date of Patent: **\*\* Nov. 10, 1992**

[54] FLASHLIGHT

1,408,527	3/1922	Lyttne .....	362/190
2,259,673	10/1941	White .....	362/197
2,299,035	10/1942	Rothenberg et al. ....	362/158
2,716,700	8/1955	La France .....	362/184

[75] Inventor: **Kam-Kwei Leung, Kwai Chung, Hong Kong**

[73] Assignee: **Dragon Success Industrial Ltd., Hong Kong**

*Primary Examiner*—Susan J. Lucas  
*Attorney, Agent, or Firm*—Burns, Doane, Swecker & Mathis

[\*\*] Term: **14 Years**

### [57] CLAIM

[21] Appl. No.: **718,111**

The ornamental design for a flashlight, as shown and described.

[22] Filed: **Jun. 20, 1991**

[52] U.S. Cl. .... **D26/37**

[58] Field of Search ..... **D26/37-50;**  
362/157, 158, 183-191, 194-202, 205

### DESCRIPTION

FIG. 1 is a front elevational view of a flashlight showing my new design;

FIG. 2 is a rear elevational view thereof;

FIG. 3 is a left side elevational view thereof;

FIG. 4 is a right side elevational view thereof;

FIG. 5 is a top plan view thereof; and,

FIG. 6 is a bottom plan view thereof.

### [56] References Cited

#### U.S. PATENT DOCUMENTS

D. 136,756	11/1943	Barash .....	D26/37
D. 137,264	2/1944	Lippincott .....	D26/37

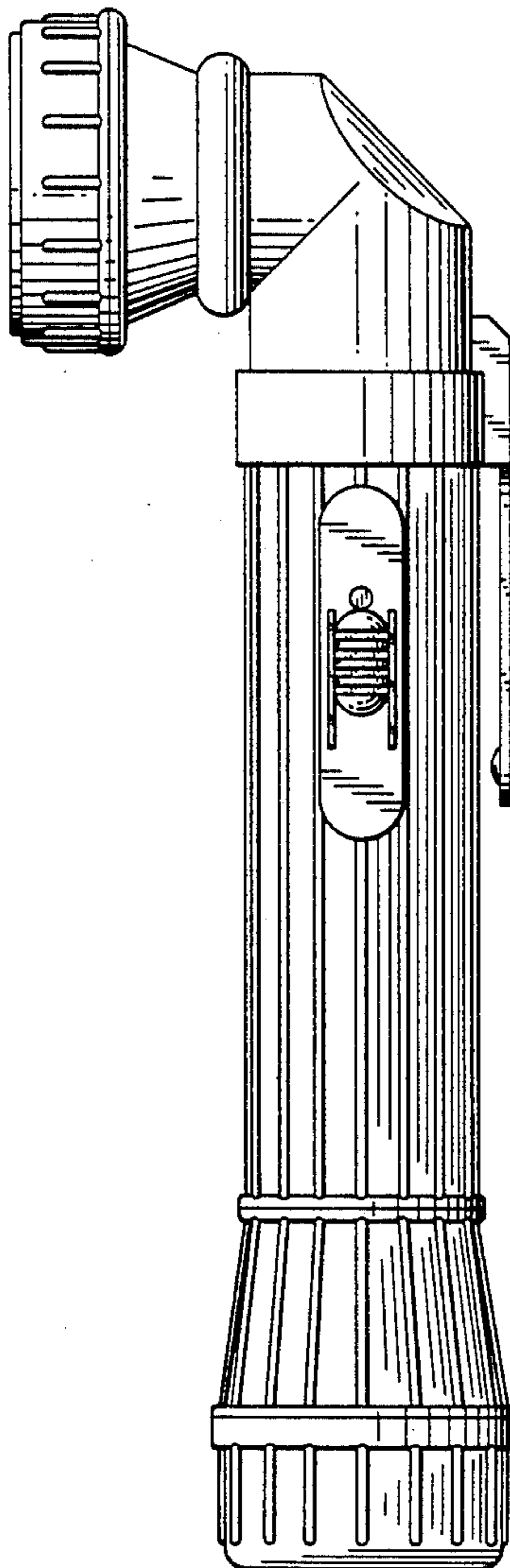

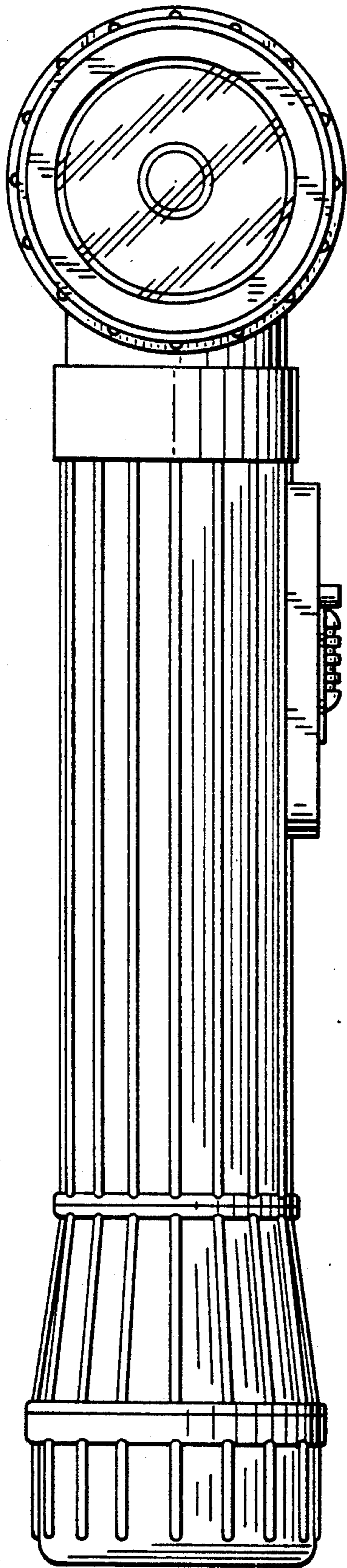

FIG. 1

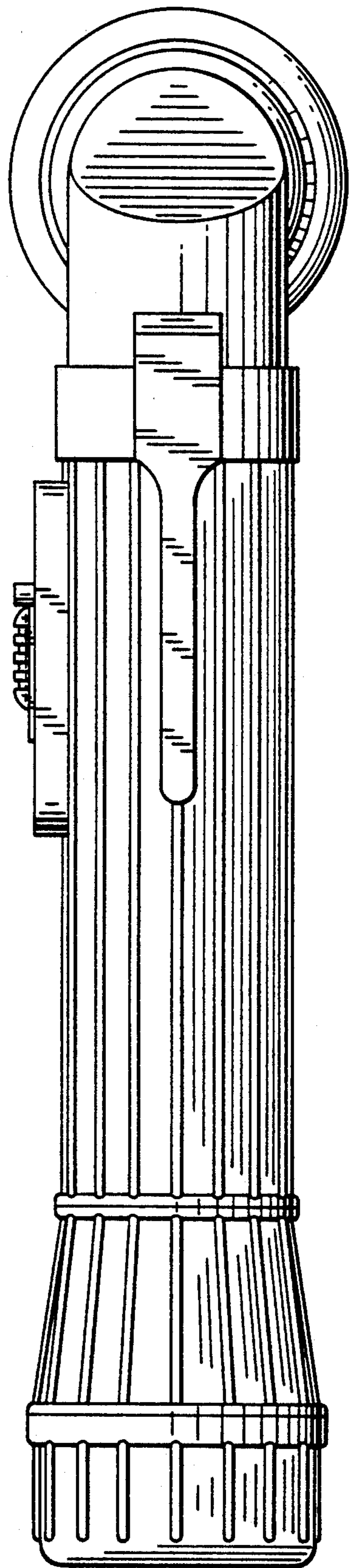

FIG. 2

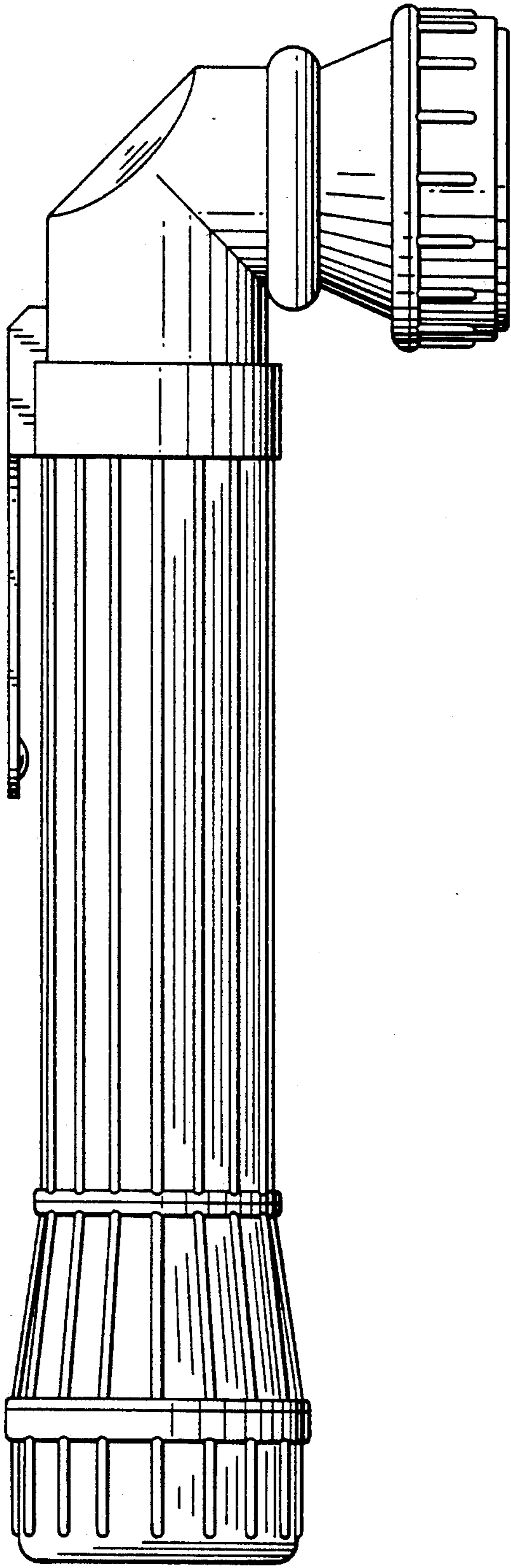

FIG. 3

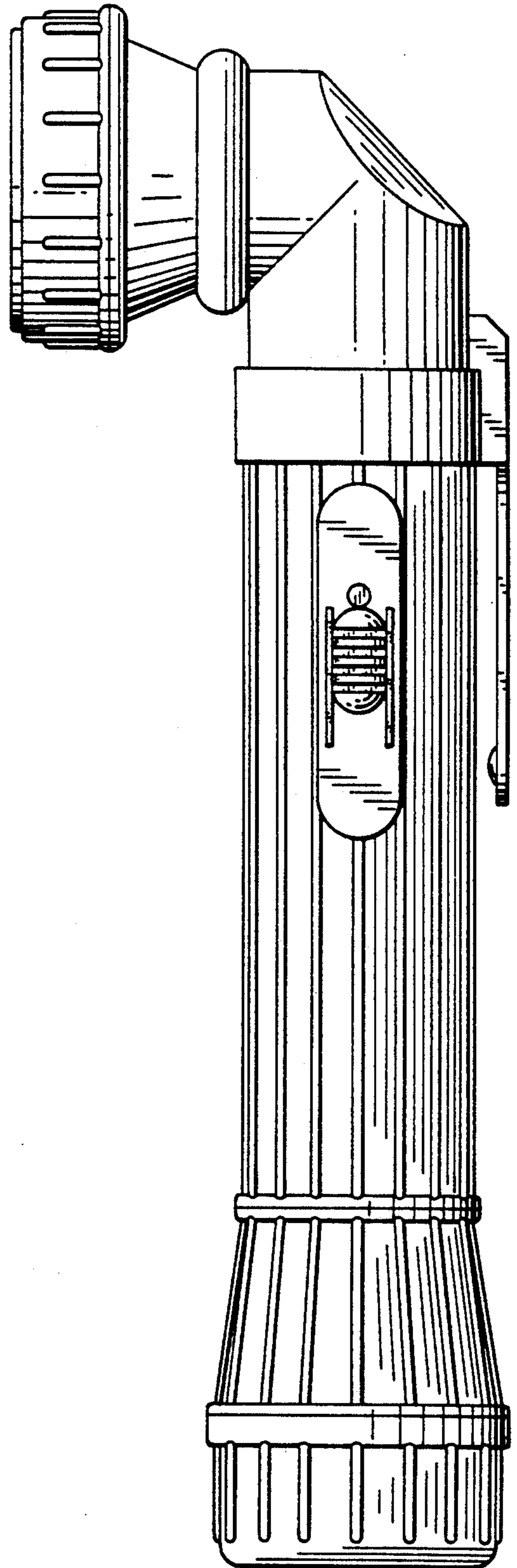

FIG. 4

FIG. 5

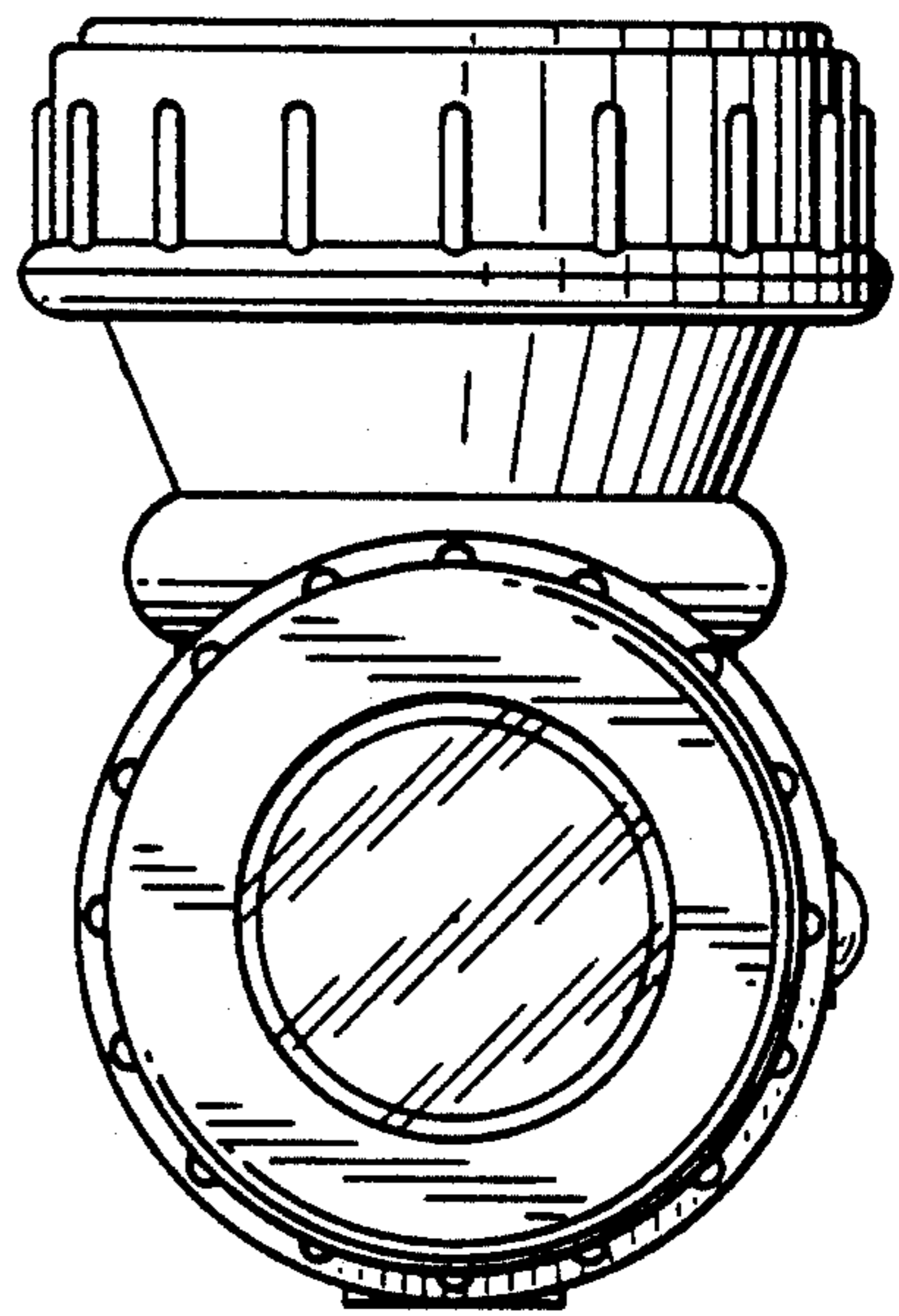
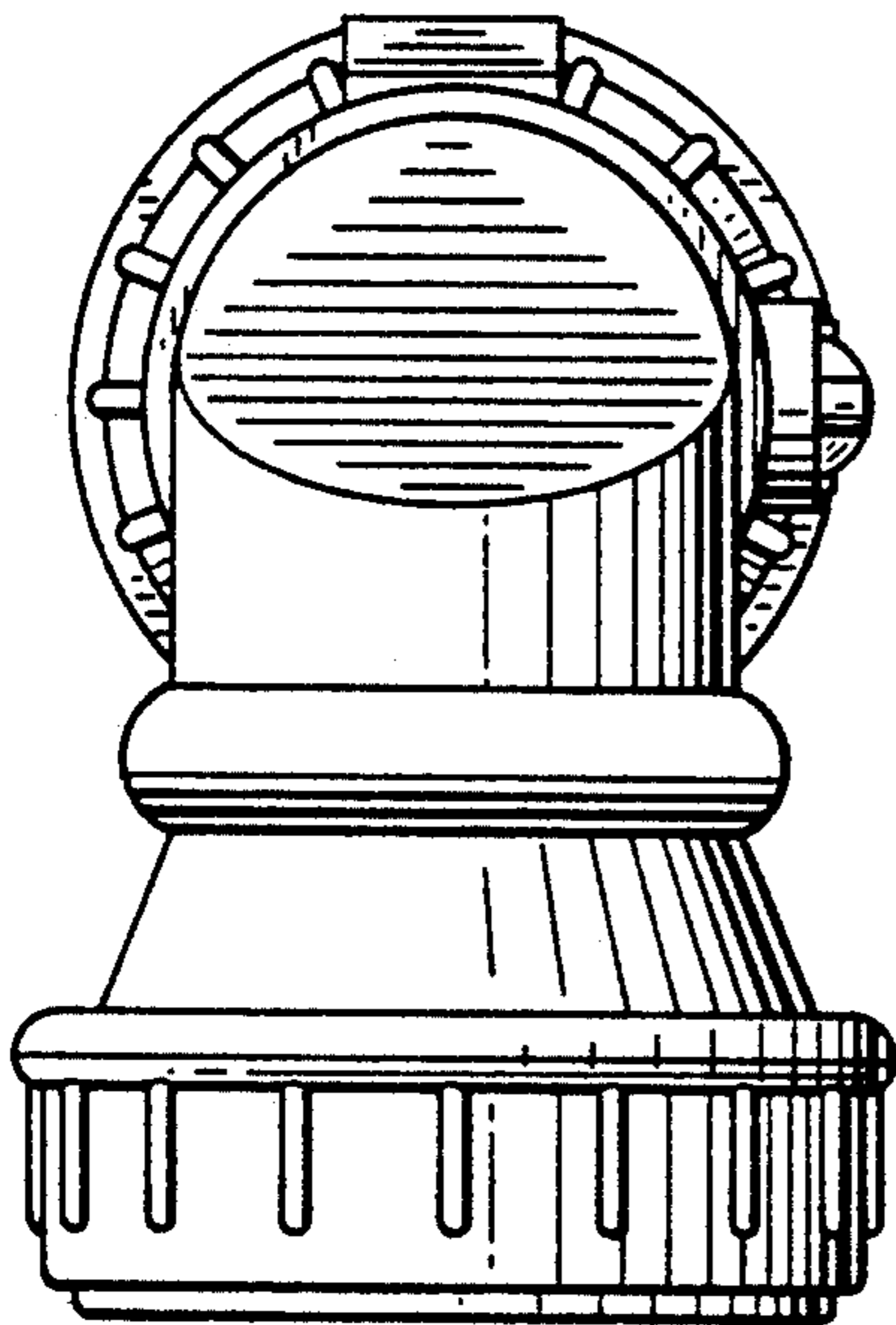

FIG. 6