



US00D330940S

United States Patent [19]

[11] Patent Number: Des. 330,940

Engel

[45] Date of Patent: ** Nov. 10, 1992

[54] LABORATORY TABLE

DESCRIPTION

- [75] Inventor: Hartmut S. Engel, Freiberg am Neckar, Fed. Rep. of Germany
- [73] Assignee: Ernst Fischer GmbH & Co., Freudenstadt, Fed. Rep. of Germany
- [**] Term: 14 Years
- [21] Appl. No.: 172,636
- [22] Filed: Mar. 24, 1988
- [52] U.S. Cl. D24/234
- [58] Field of Search D24/1.1; 312/209, 223, 312/228; D6/334, 335, 336, 360, 396, 397, 422, 426, 481

FIG. 1 is a front elevational view of a laboratory table, showing my new design;
 FIG. 2 is a right side elevational view thereof;
 FIG. 3 is a left side elevational view thereof;
 FIG. 4 is a top plan view thereof;
 FIG. 5 is a bottom plan view thereof;
 FIG. 6 is a rear elevational view thereof;
 FIG. 7 is a front elevational view of a second embodiment of the laboratory table;
 FIG. 8 is a right side elevational view thereof;
 FIG. 9 is a left side elevational view thereof;
 FIG. 10 is a top plan view thereof;
 FIG. 11 is a bottom plan view thereof;
 FIG. 12 is a rear elevational view thereof;
 FIG. 13 is a front elevational view of a third embodiment of the laboratory table;
 FIG. 14 is a right side elevational view thereof;
 FIG. 15 is a left side elevational view thereof;
 FIG. 16 is a rear elevational view thereof;
 FIG. 17 is a bottom plan view thereof;
 FIG. 18 is a top plan view thereof;
 FIG. 19 is a front, top, perspective view of FIG. 1;
 FIG. 20 is a front, top, left side perspective view of a fifth embodiment of the laboratory table;
 FIG. 21 is a front, top, left side perspective view of a sixth embodiment of the laboratory table;
 FIG. 22 is a front, top, left side perspective view of a seventh embodiment of the laboratory table; and,
 FIG. 23 is a rear perspective view of FIG. 13.

[56] References Cited

U.S. PATENT DOCUMENTS

- D. 186,369 10/1959 Lintereur D24/1.1
- D. 194,033 11/1962 Graham D24/1.1
- D. 197,603 3/1964 Hannon D24/1.1
- D. 252,820 9/1979 Olson D24/1.1

Primary Examiner—Stella Reid
 Attorney, Agent, or Firm—Townsend and Townsend

[57] CLAIM

The ornamental design for a laboratory table, as shown and described.

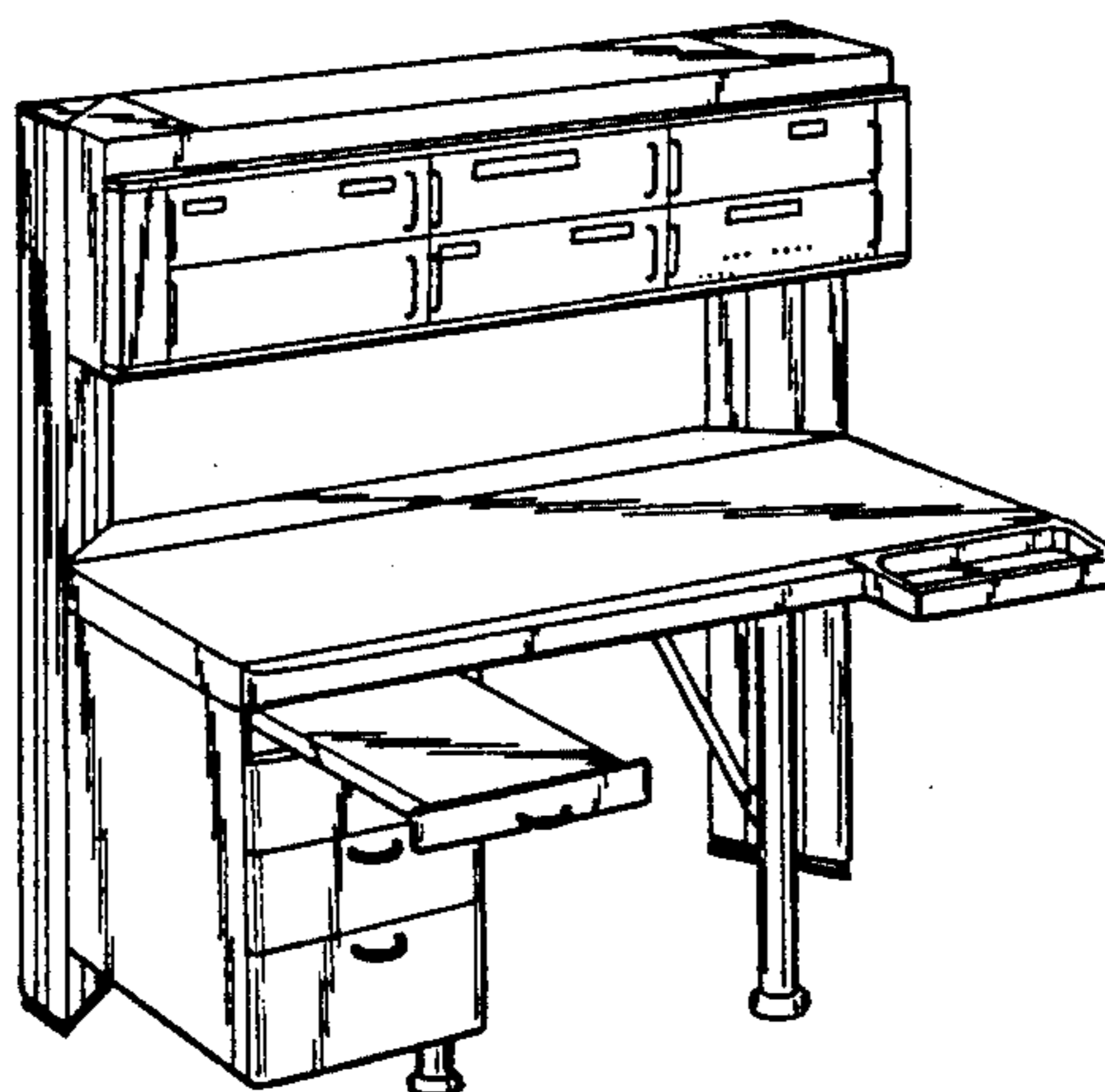
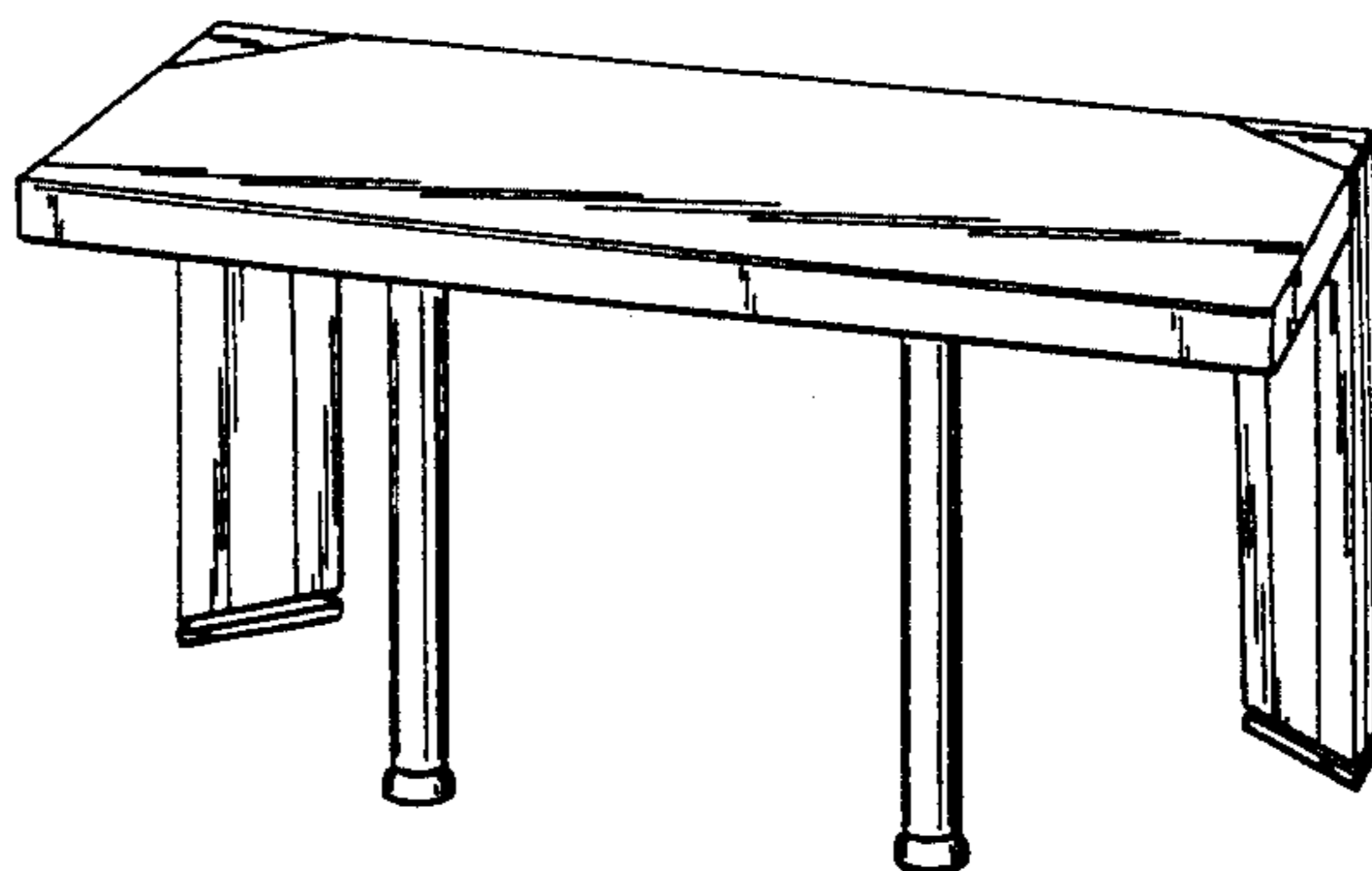

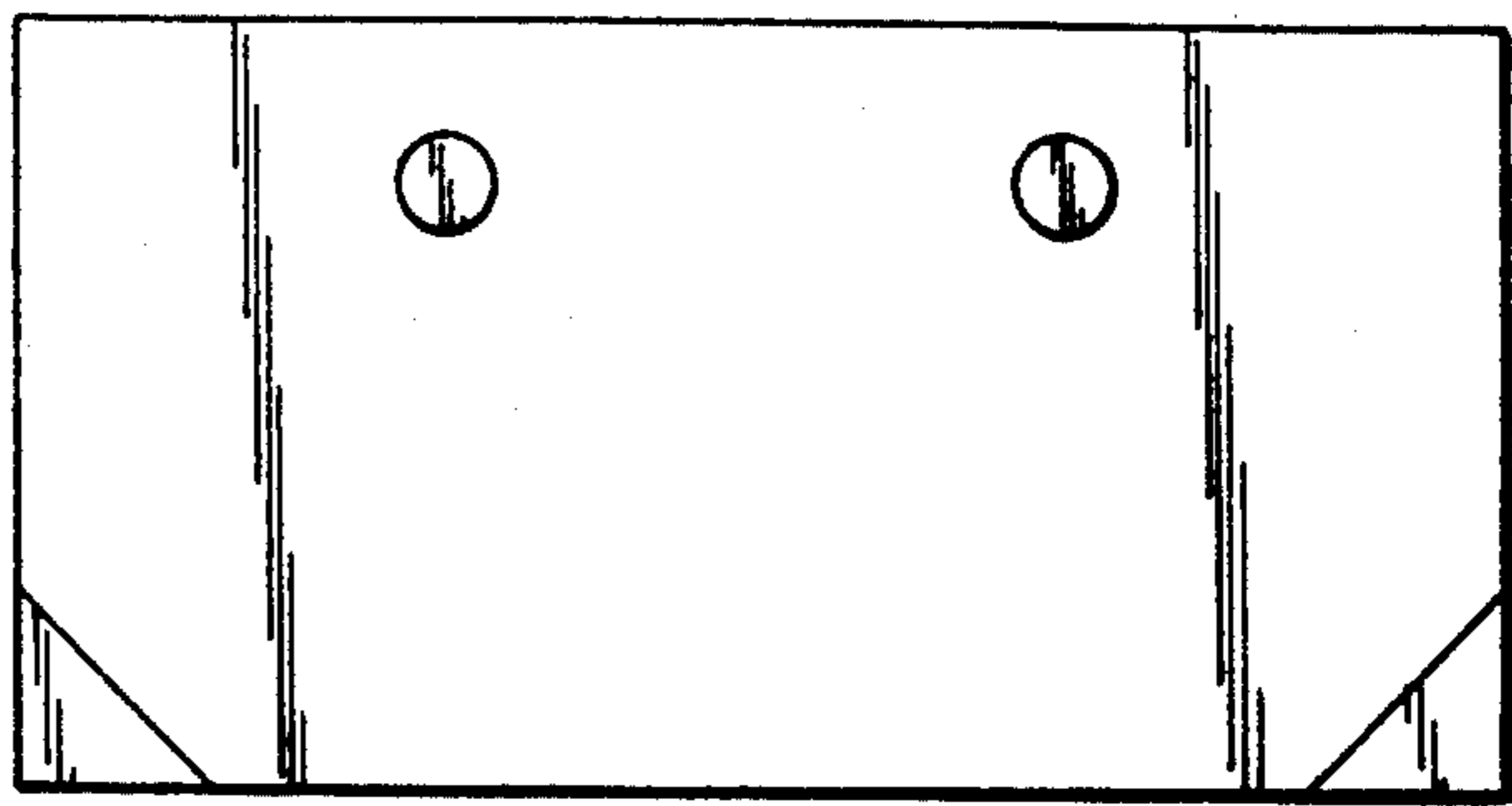

FIG. 5.

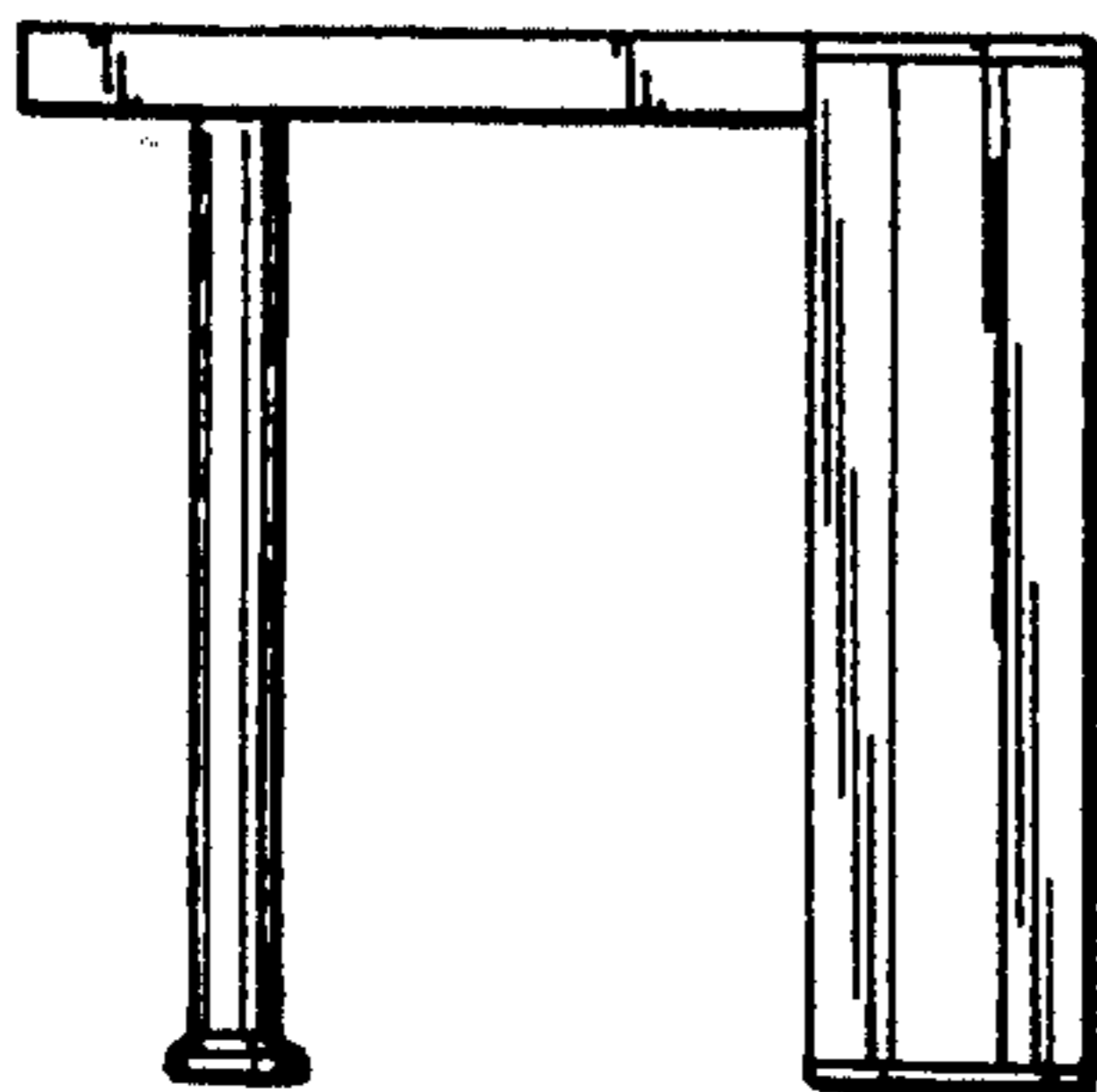

FIG. 2.

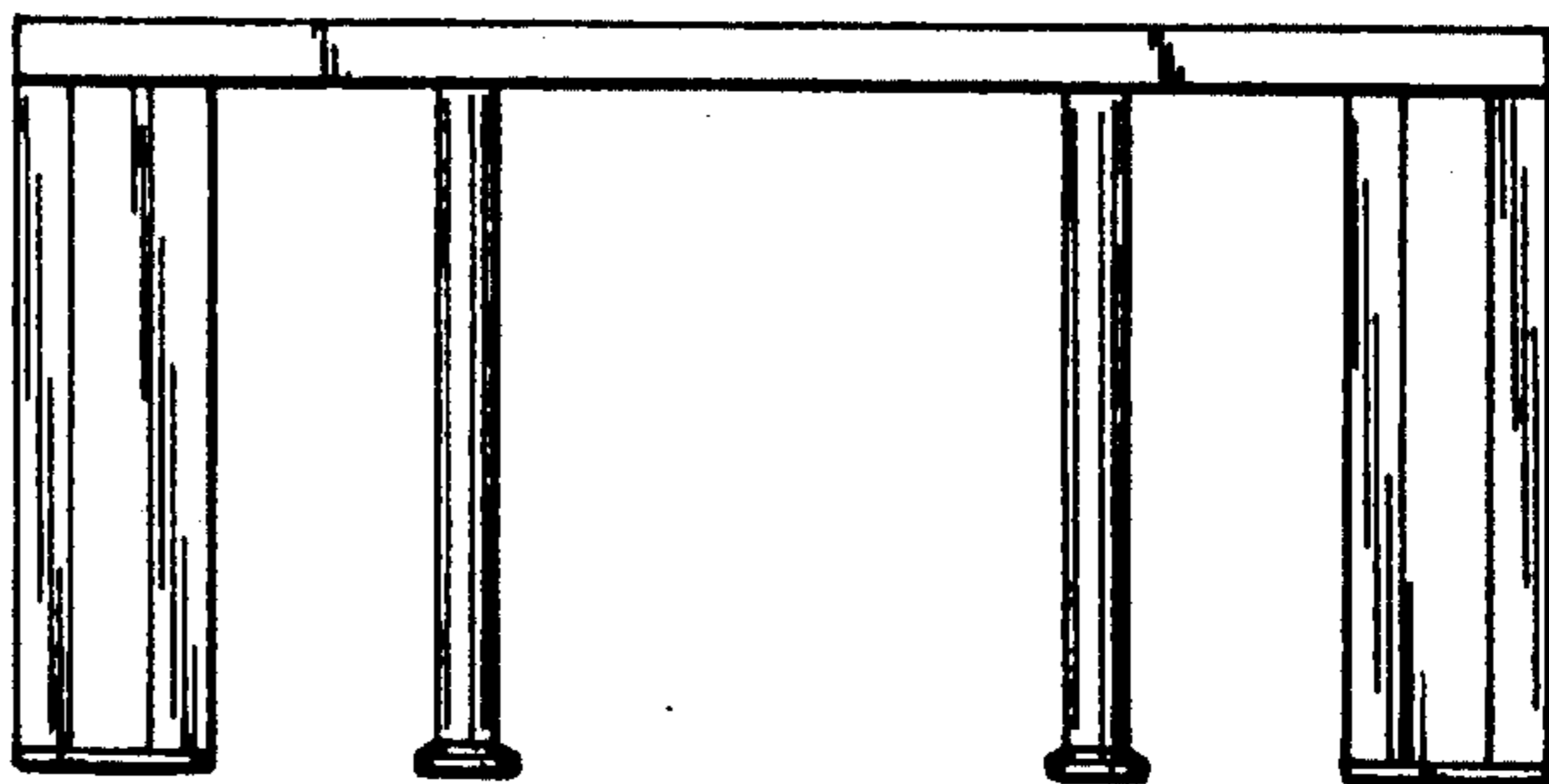

FIG. 1.

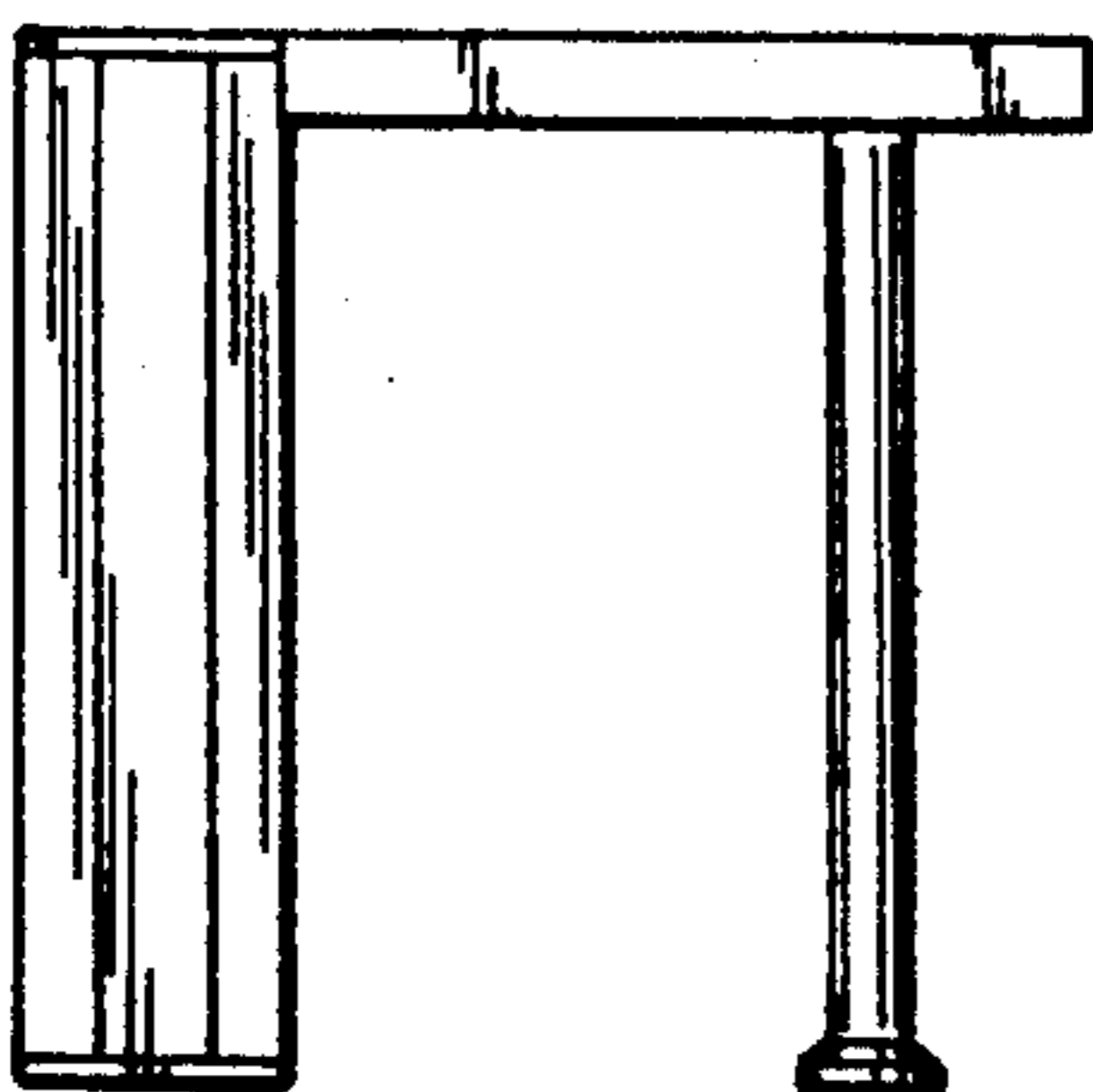

FIG. 3.

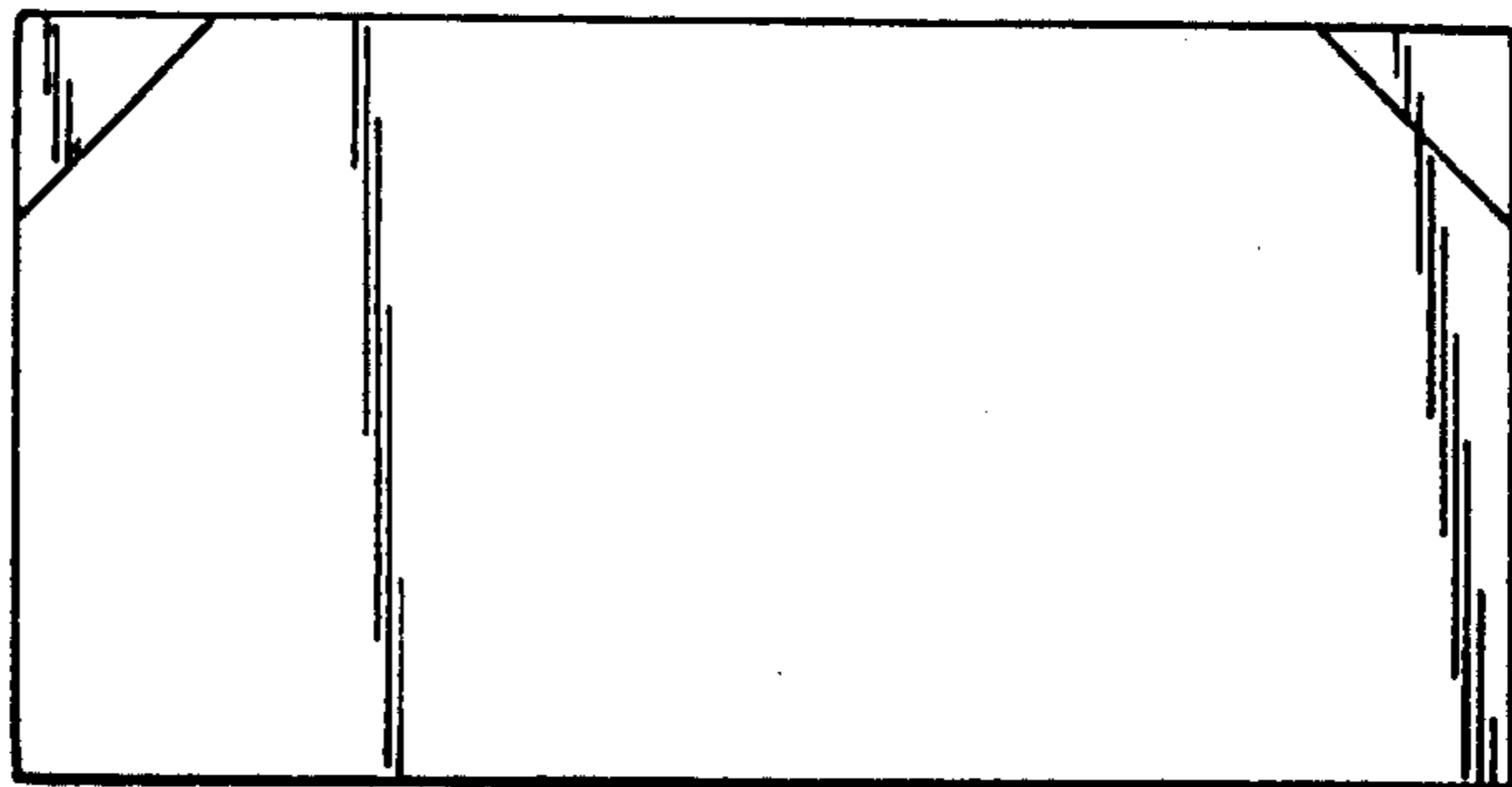

FIG. 4.

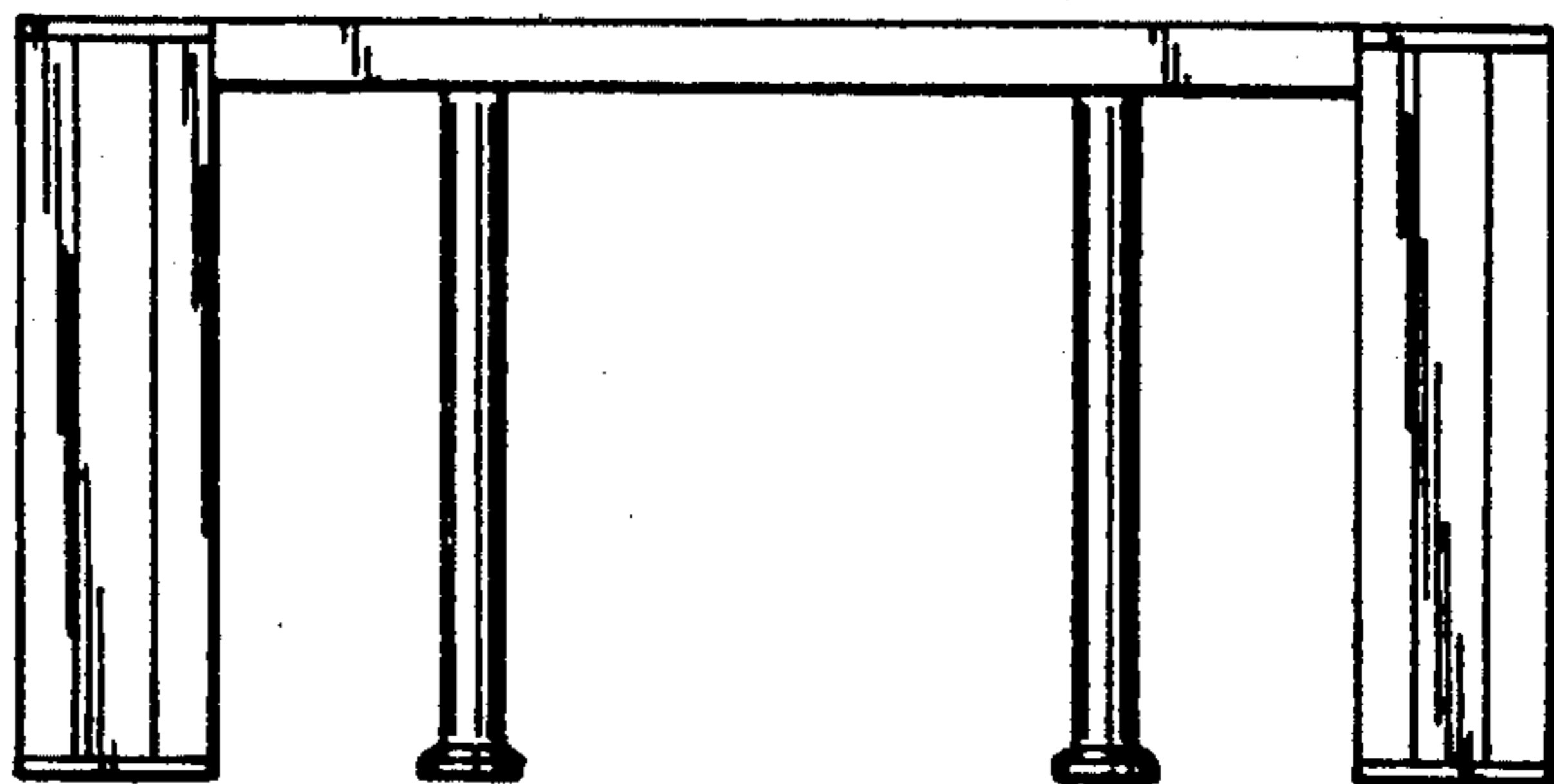

FIG. 6.

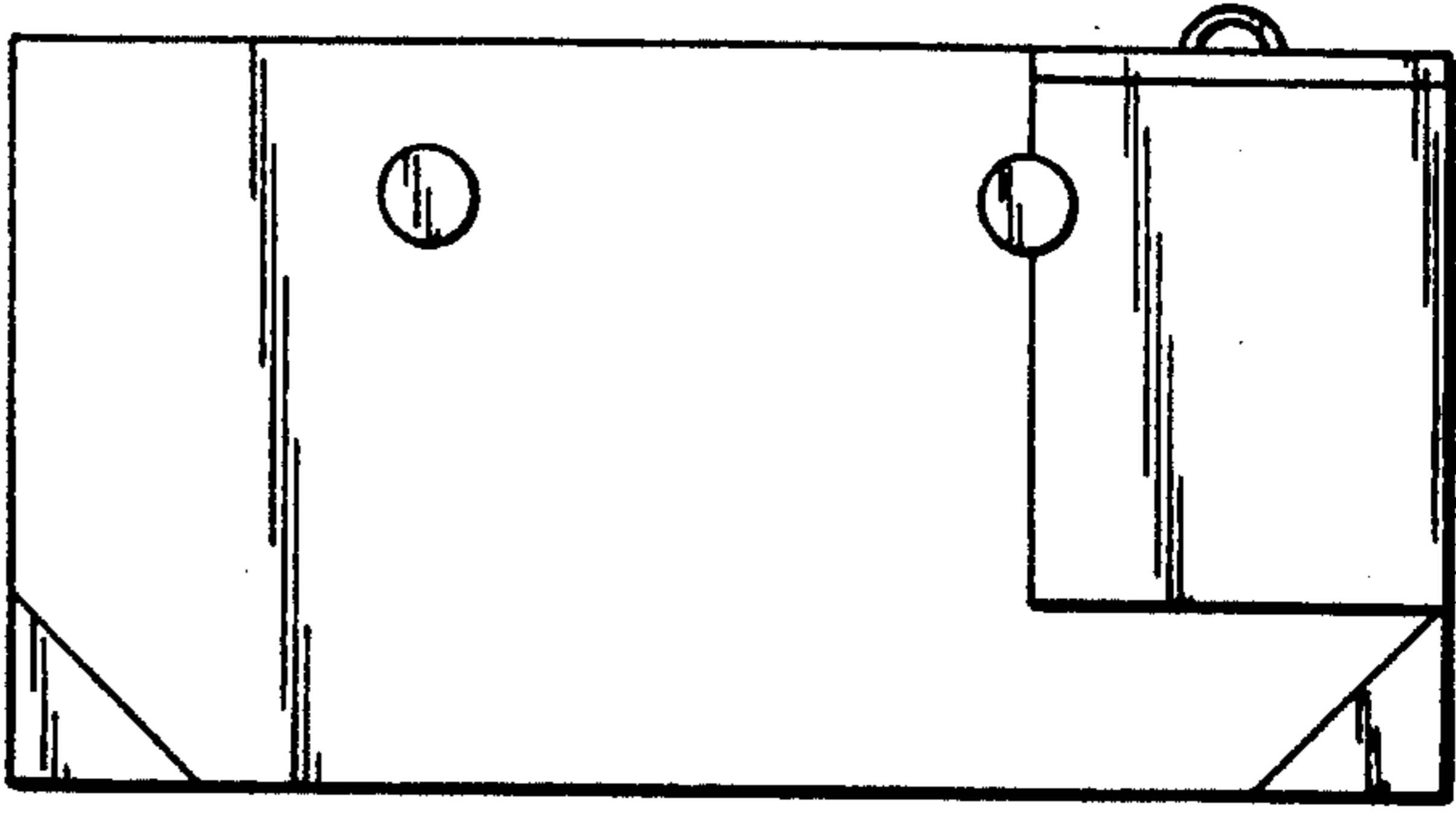

FIG. 11.

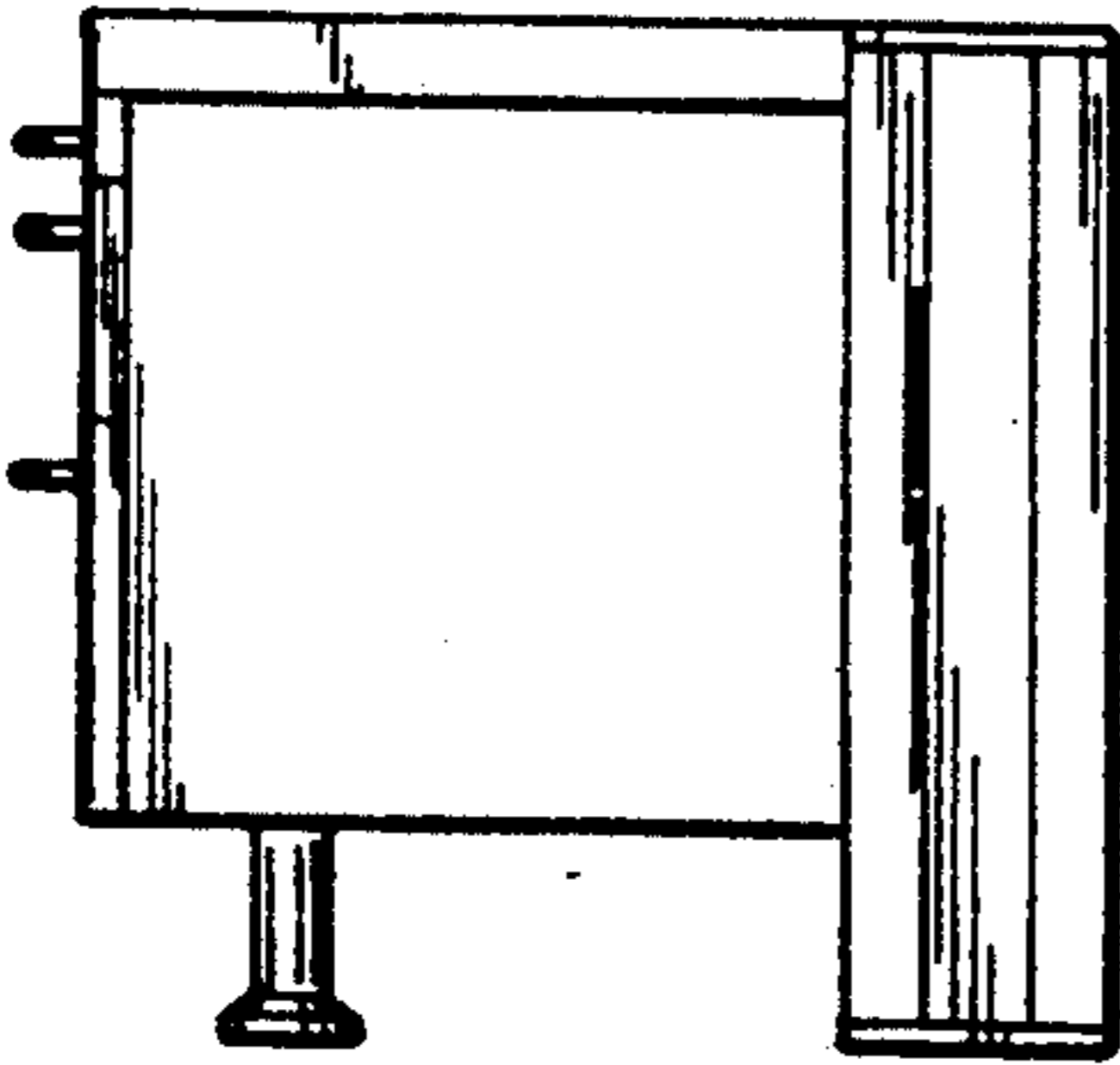

FIG. 8.

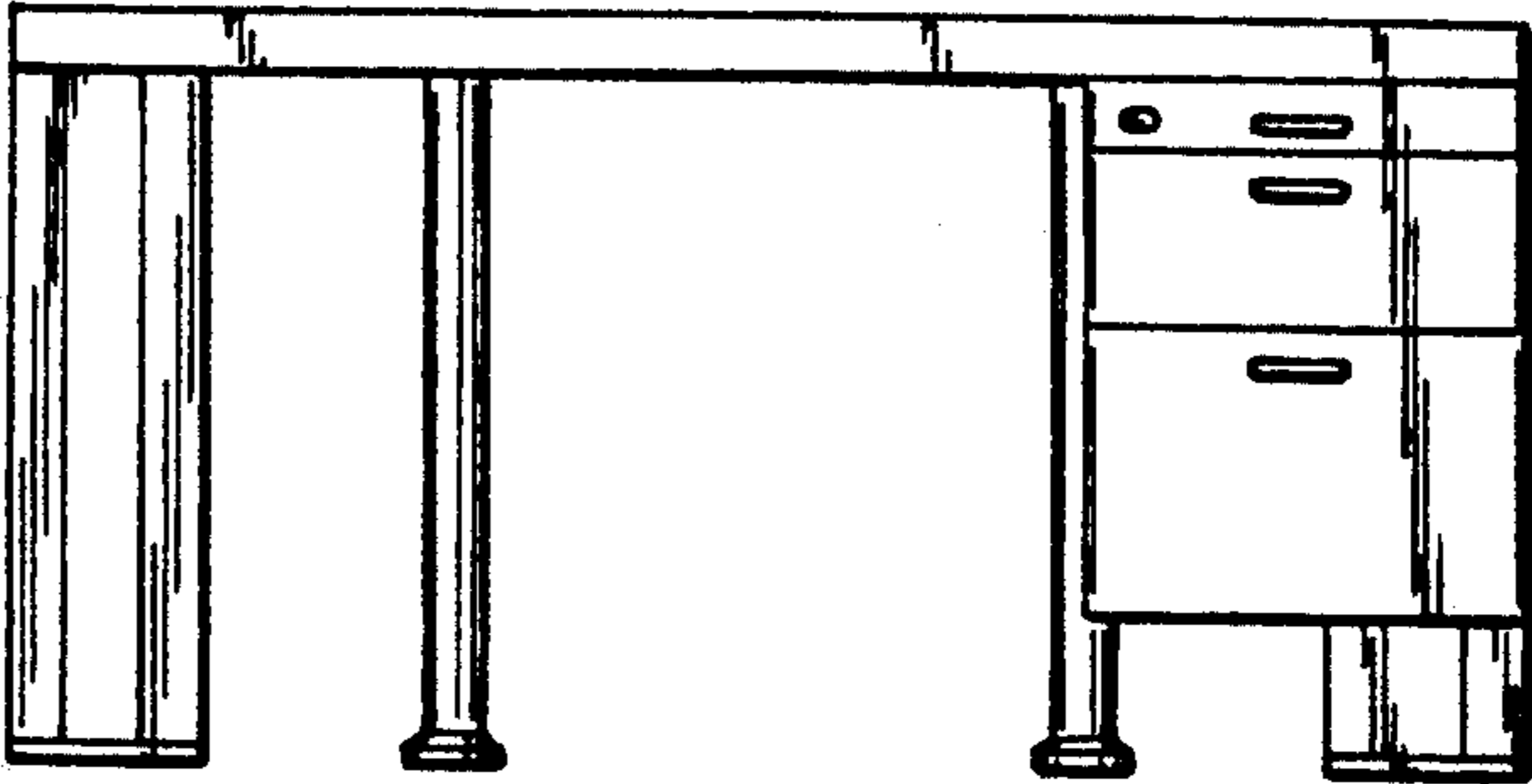

FIG. 7.

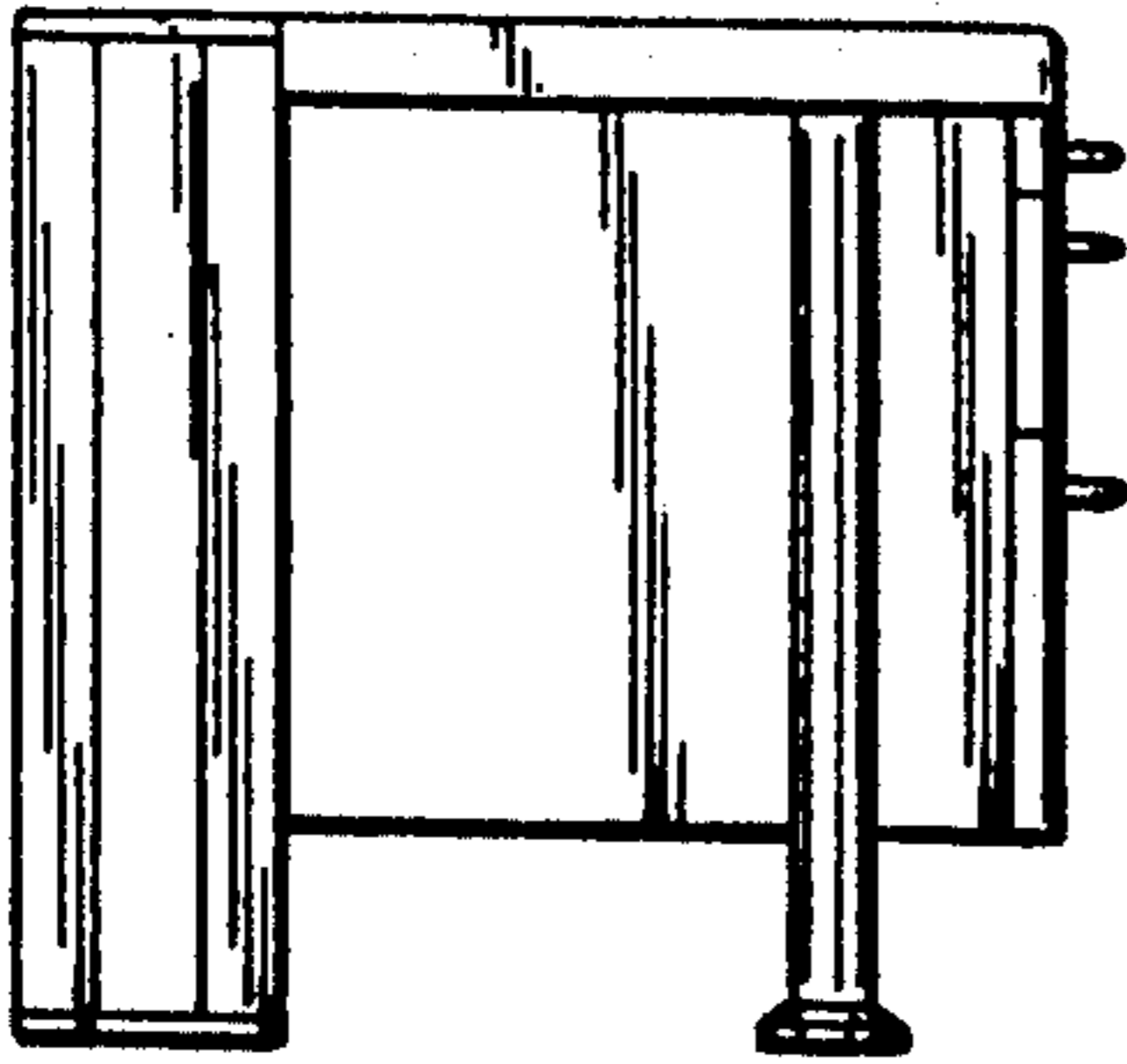

FIG. 9.

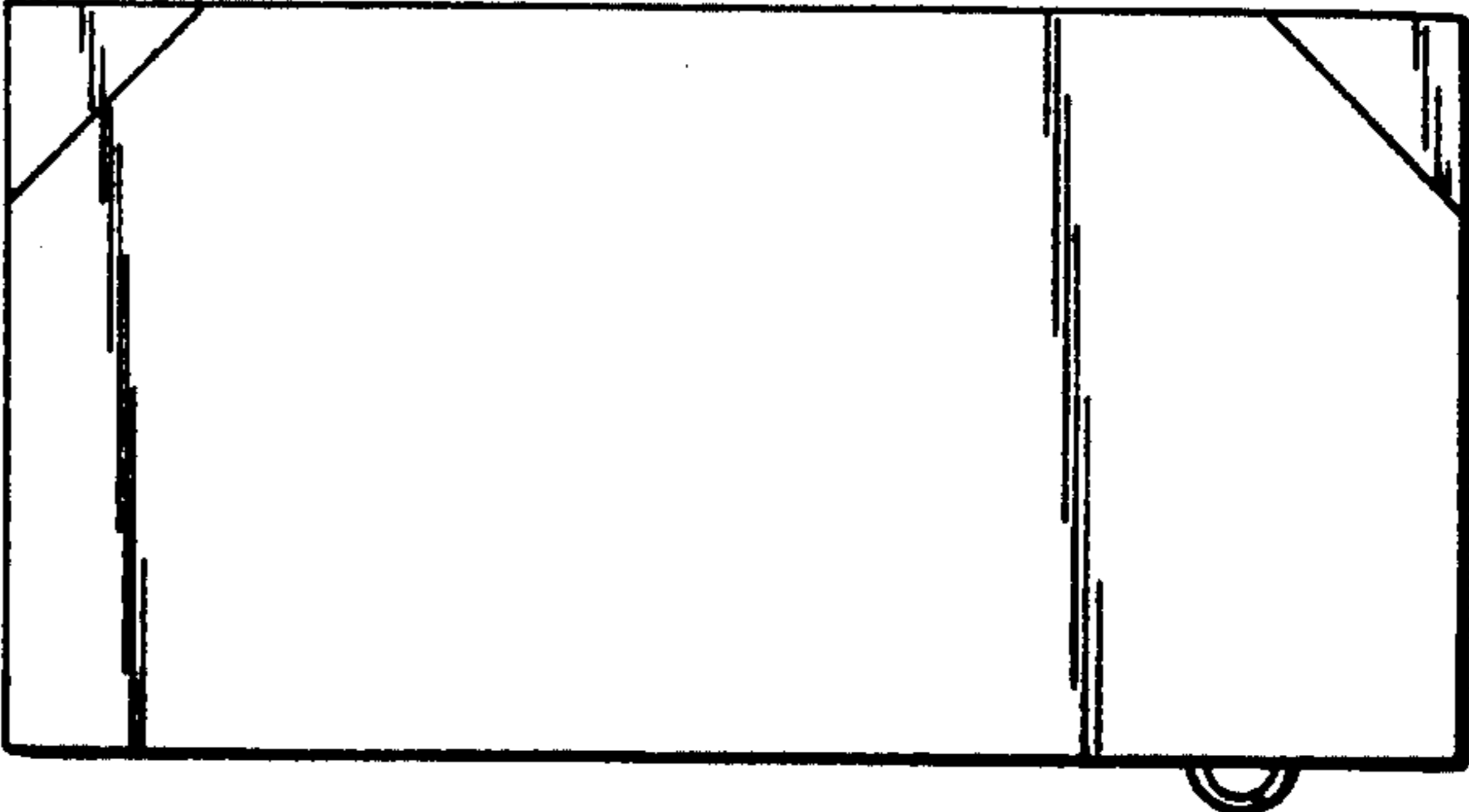

FIG. 10.

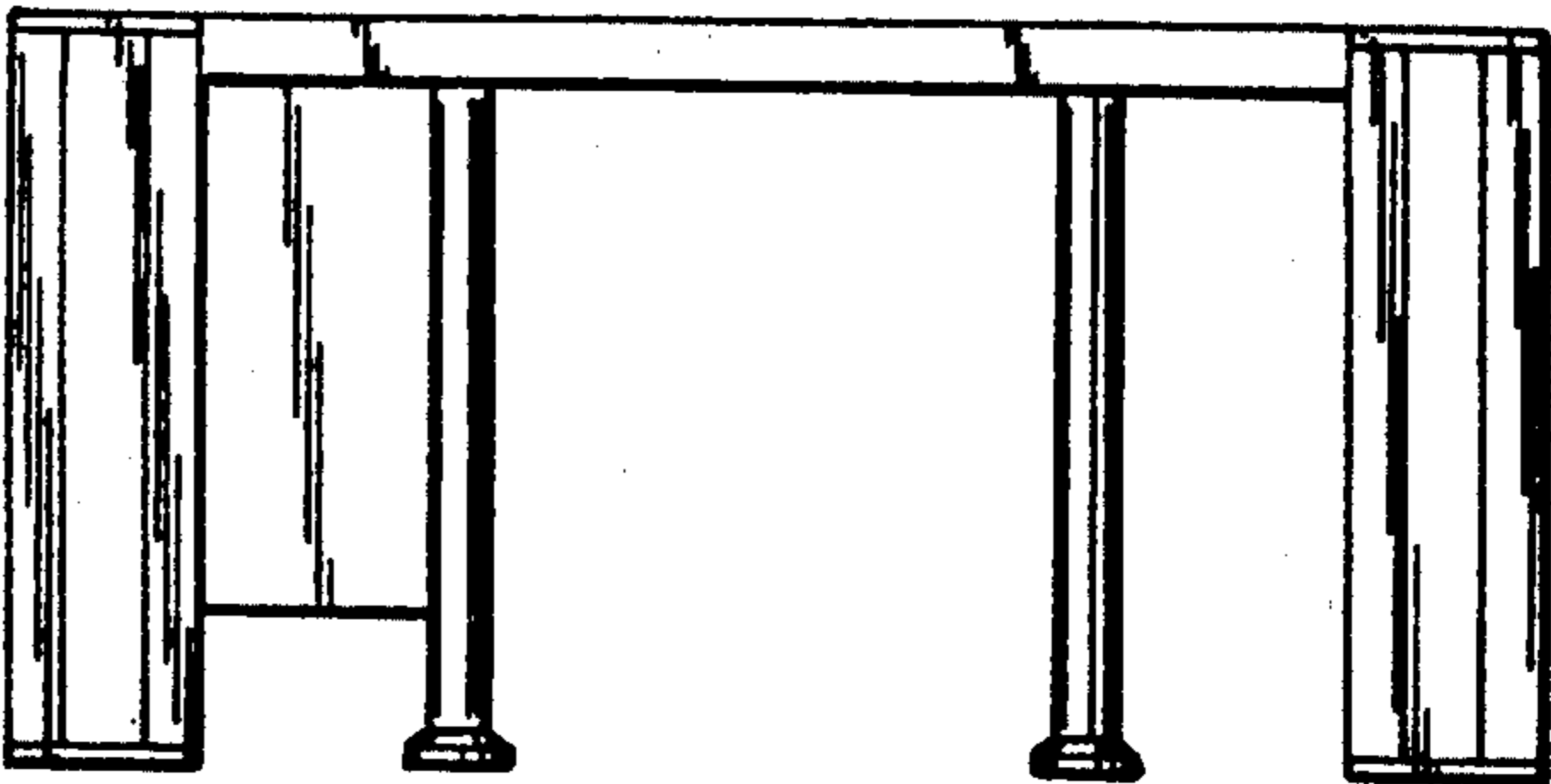

FIG. 12.

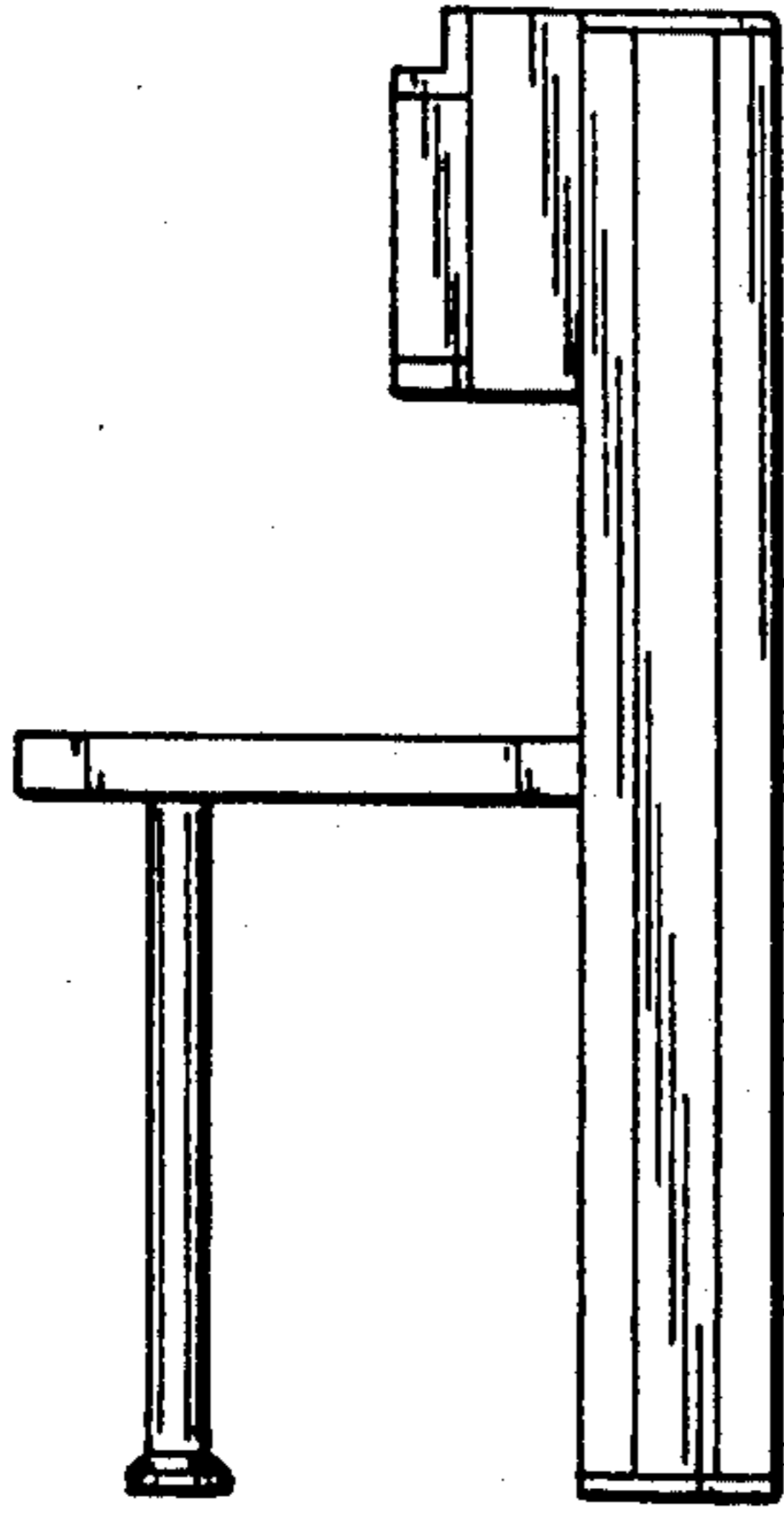

FIG. 14.

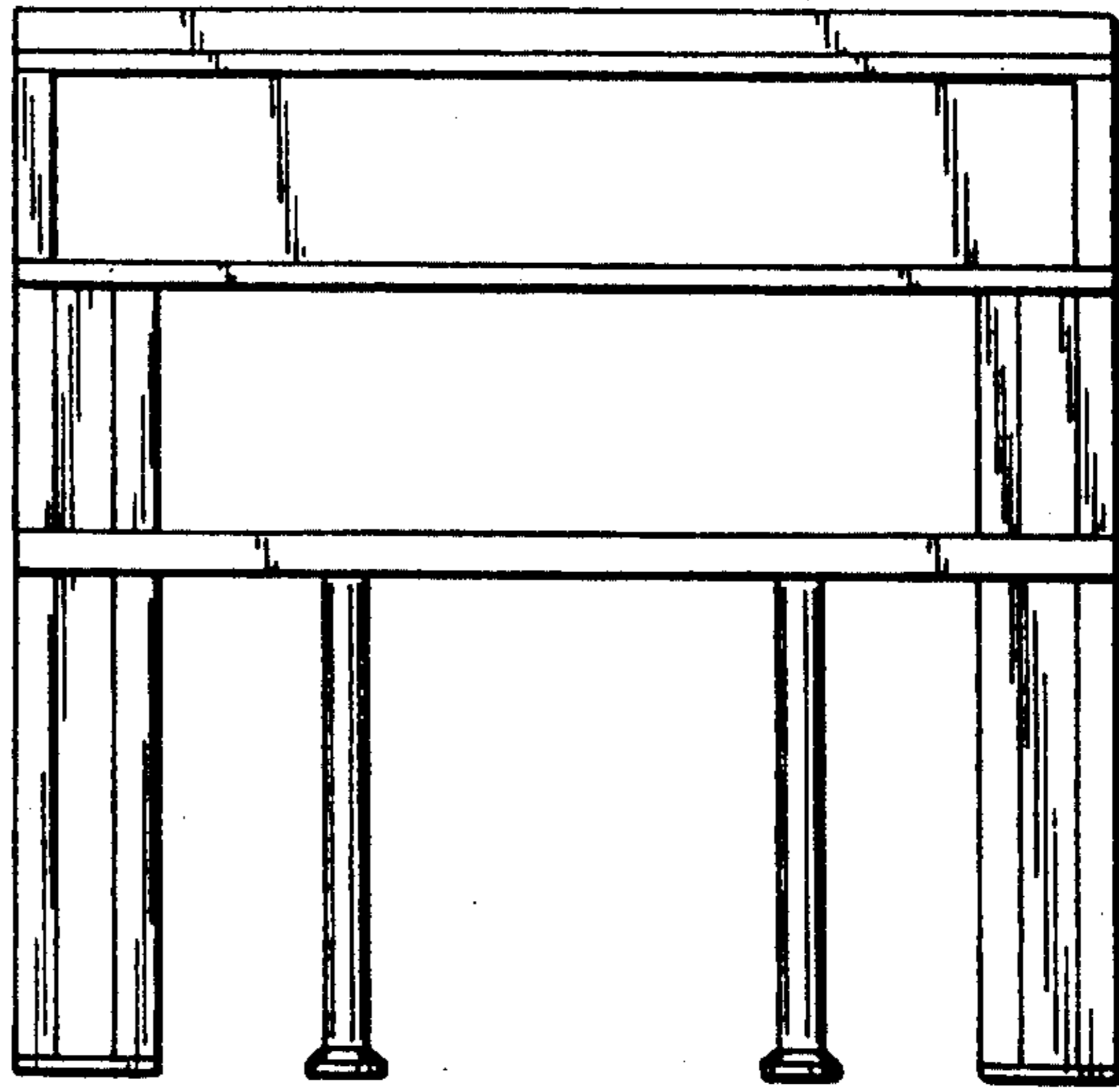

FIG. 13.

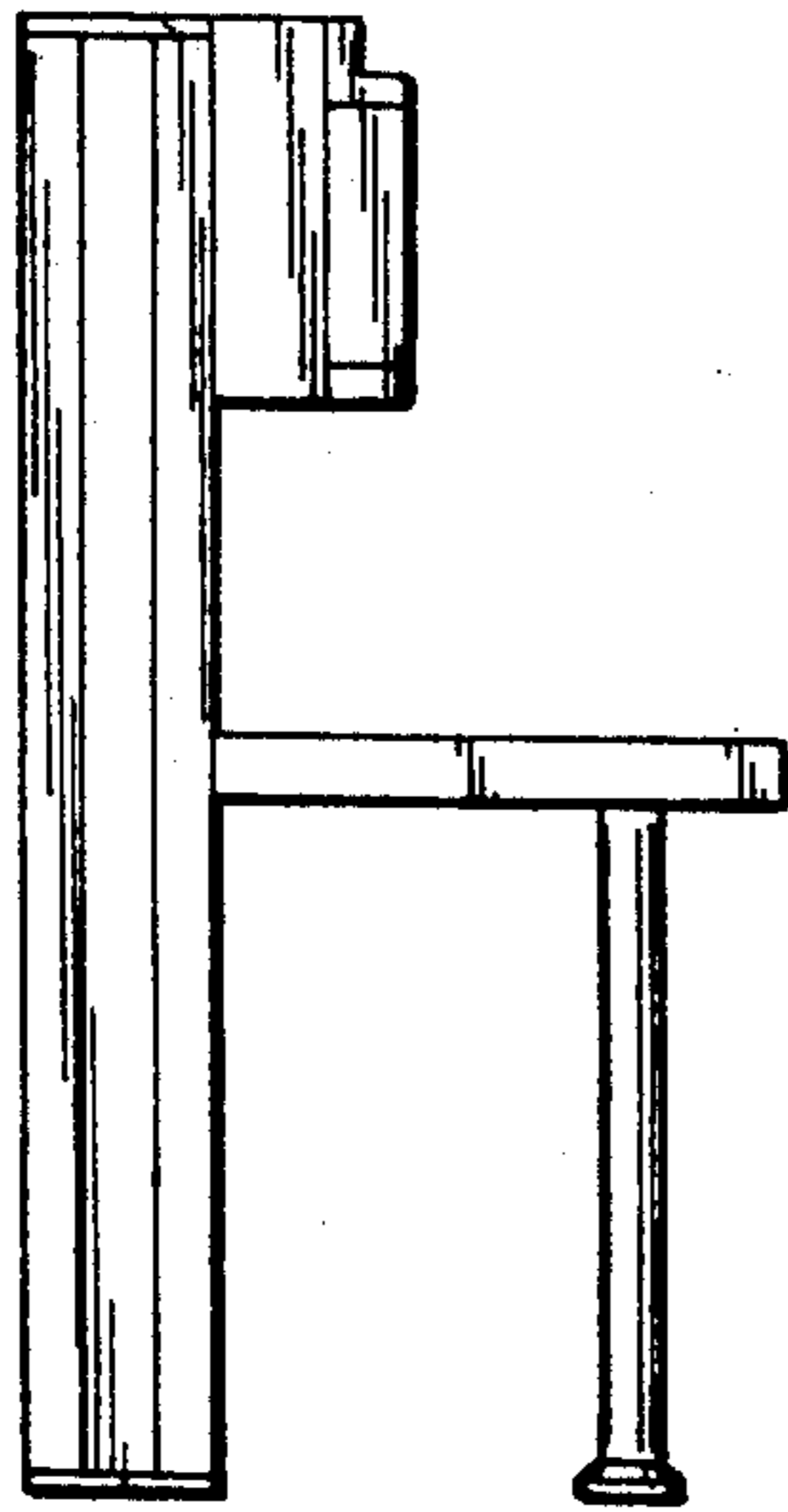

FIG. 15.

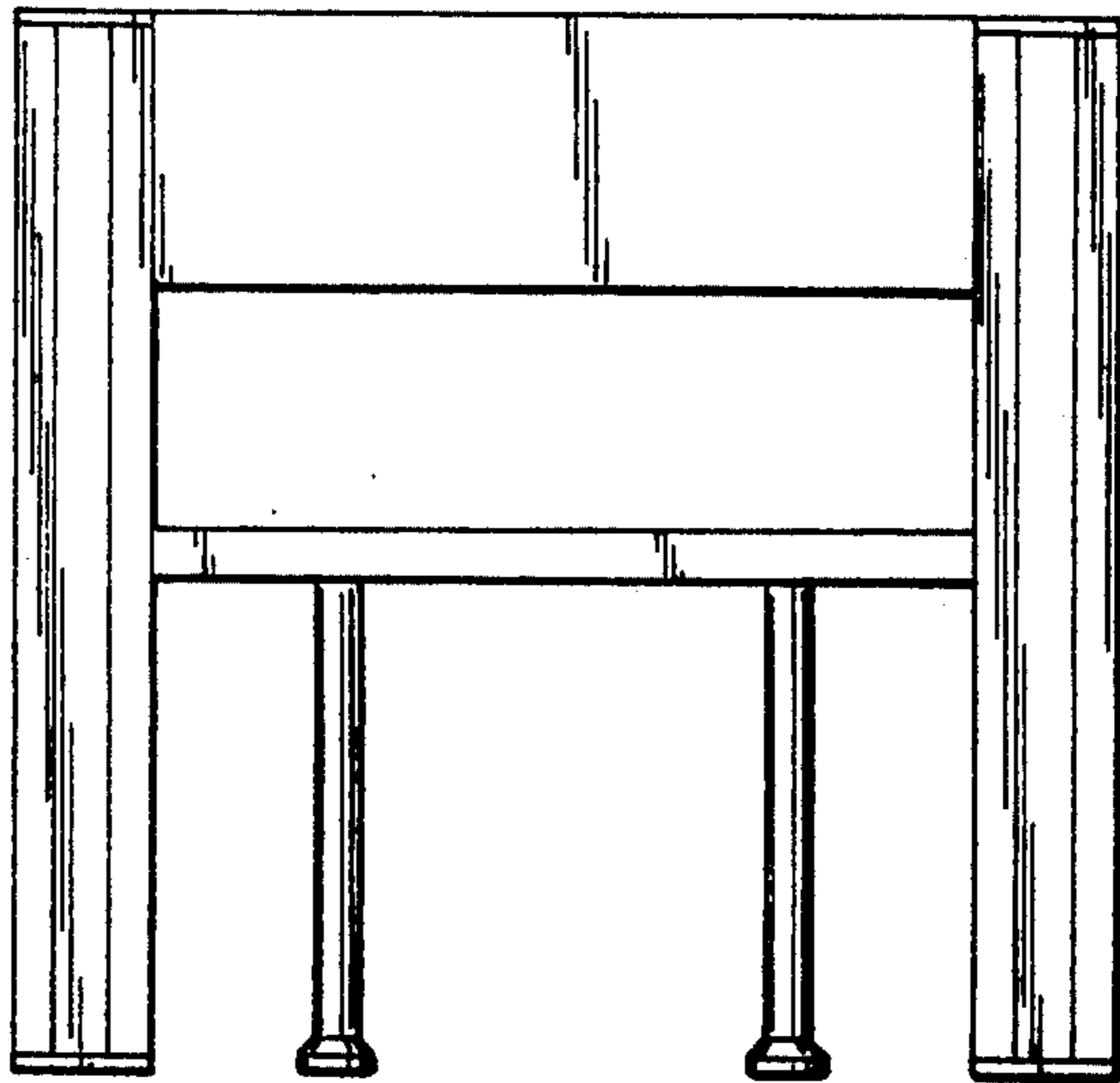

FIG. 16.

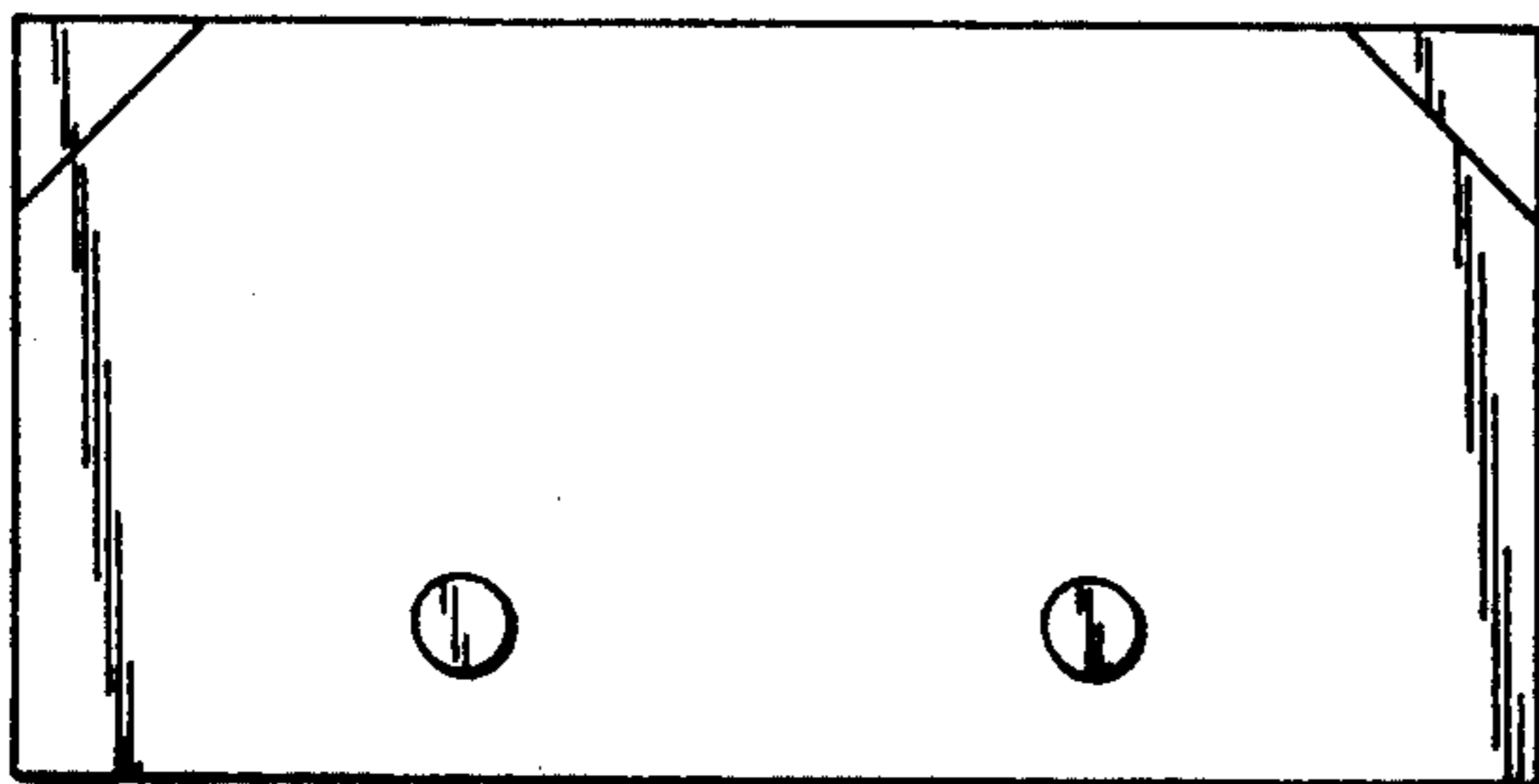

FIG. 17.

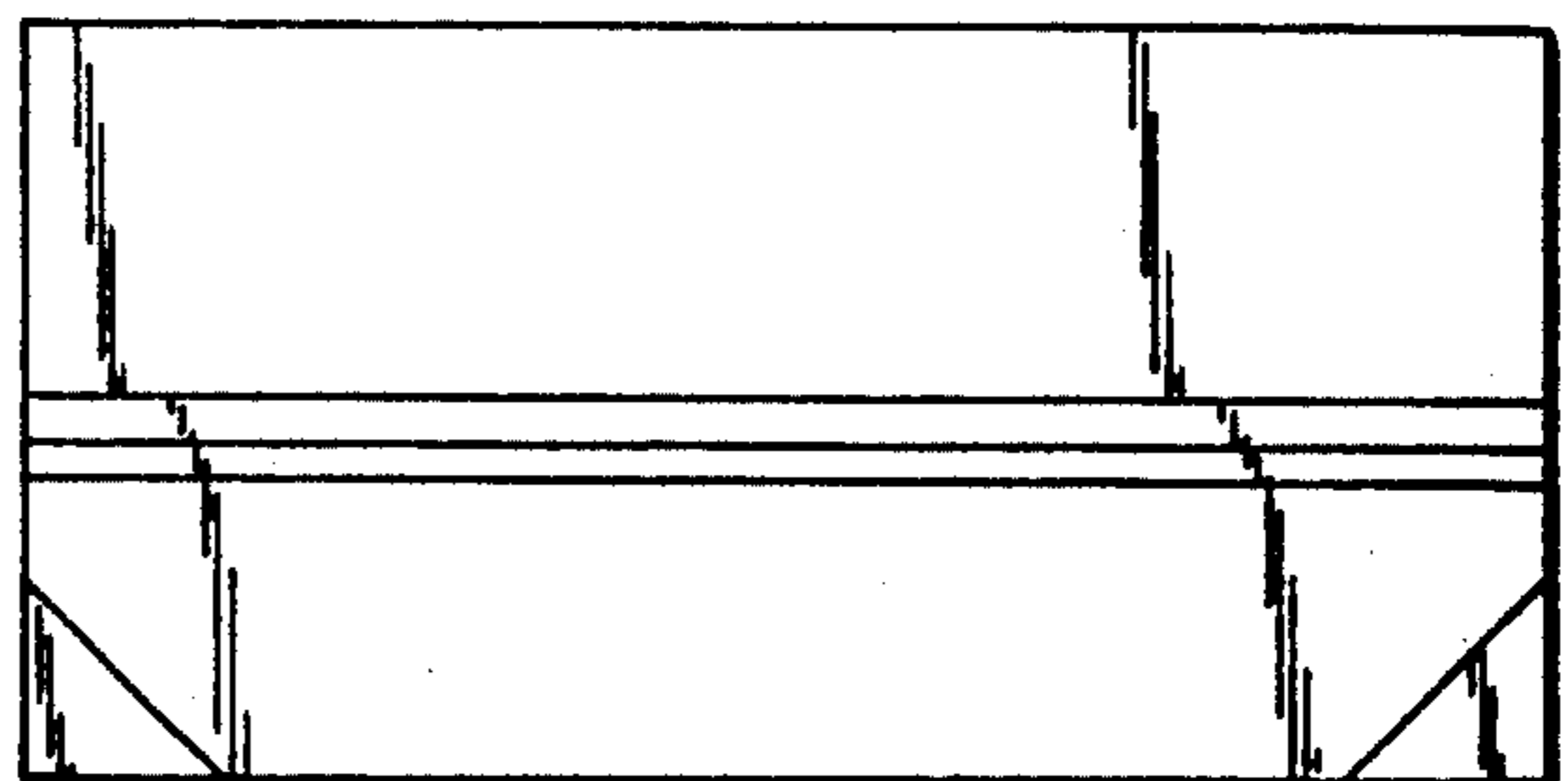

FIG. 18.

FIG. 19.

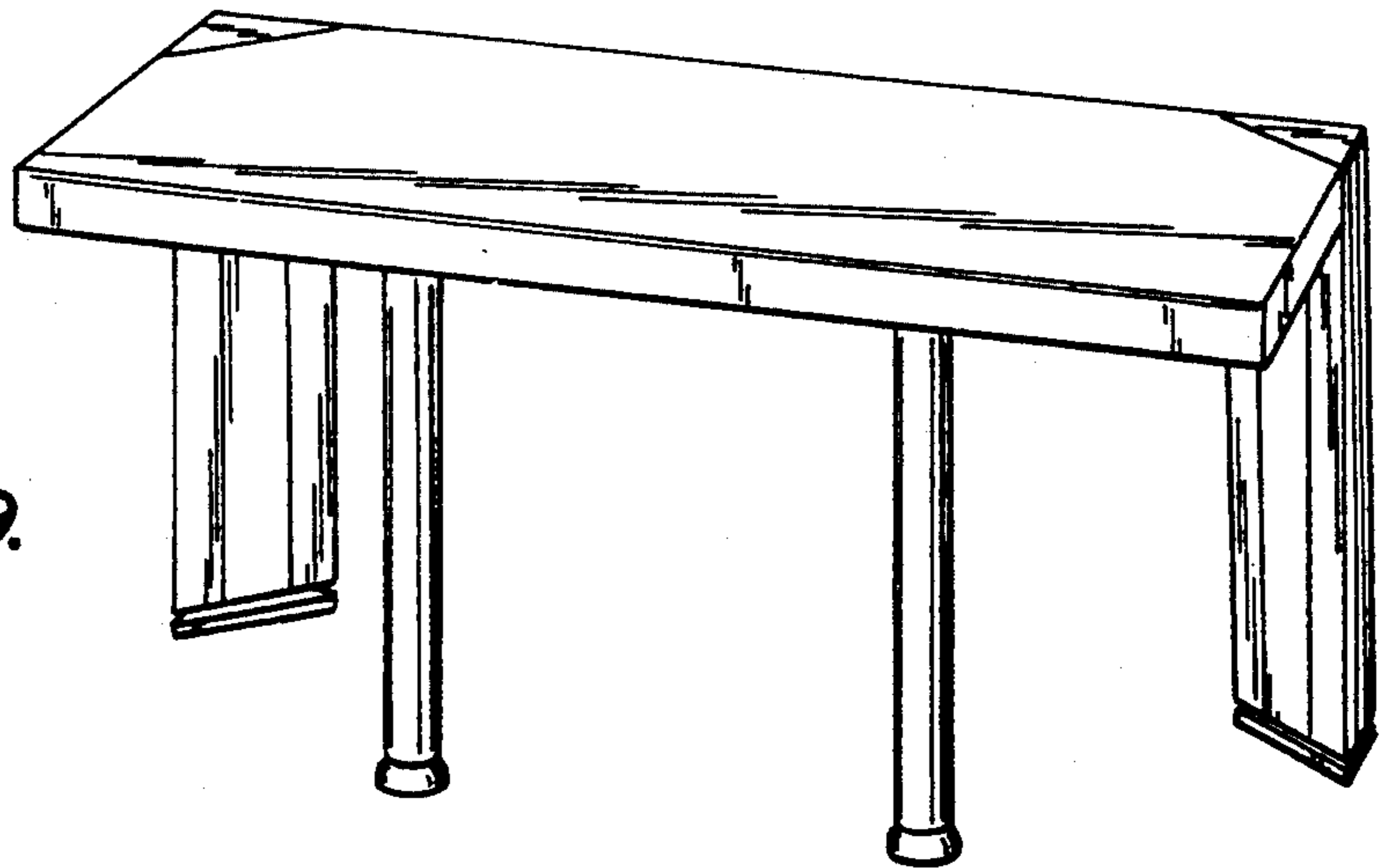

FIG. 20.

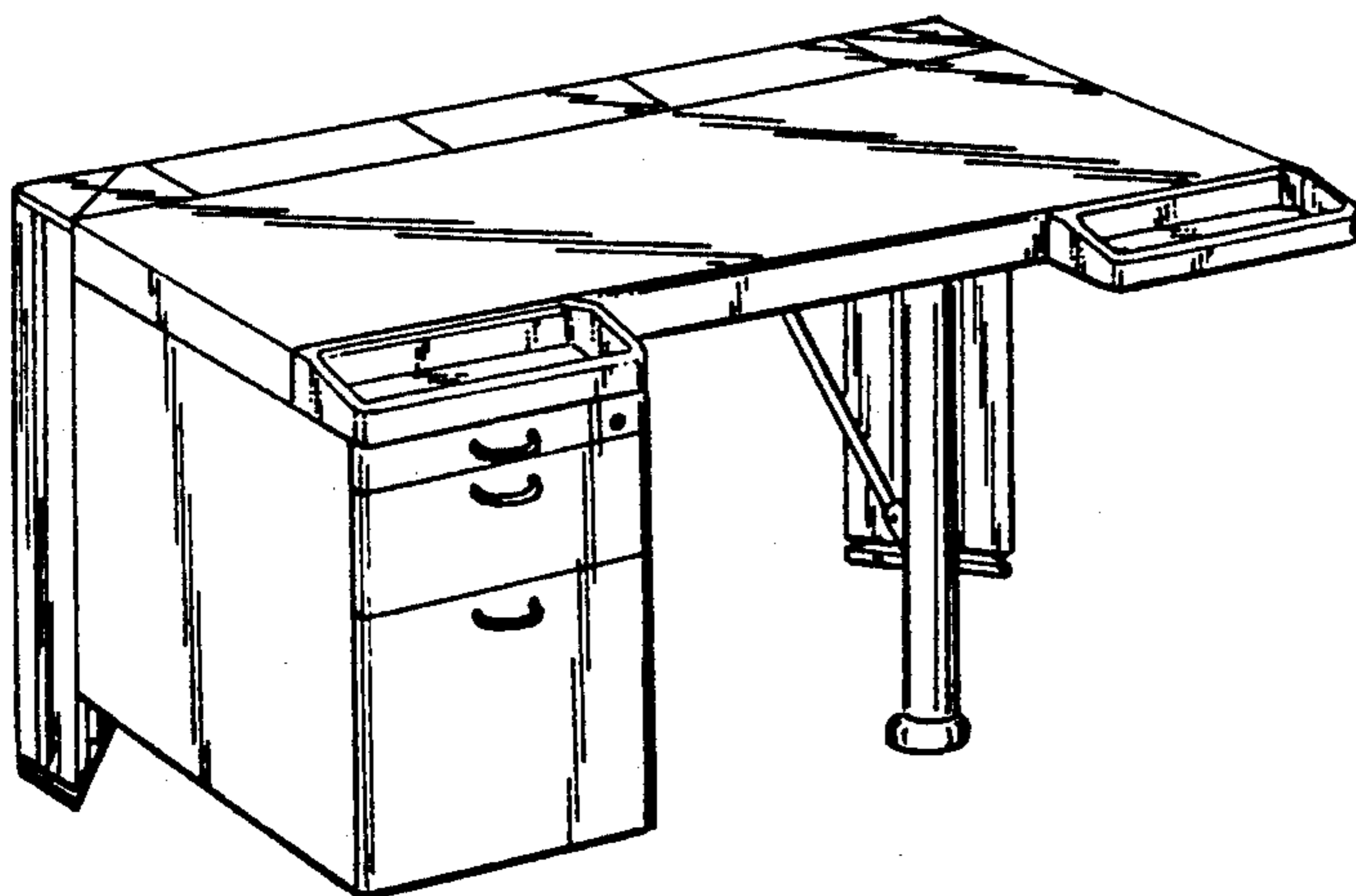
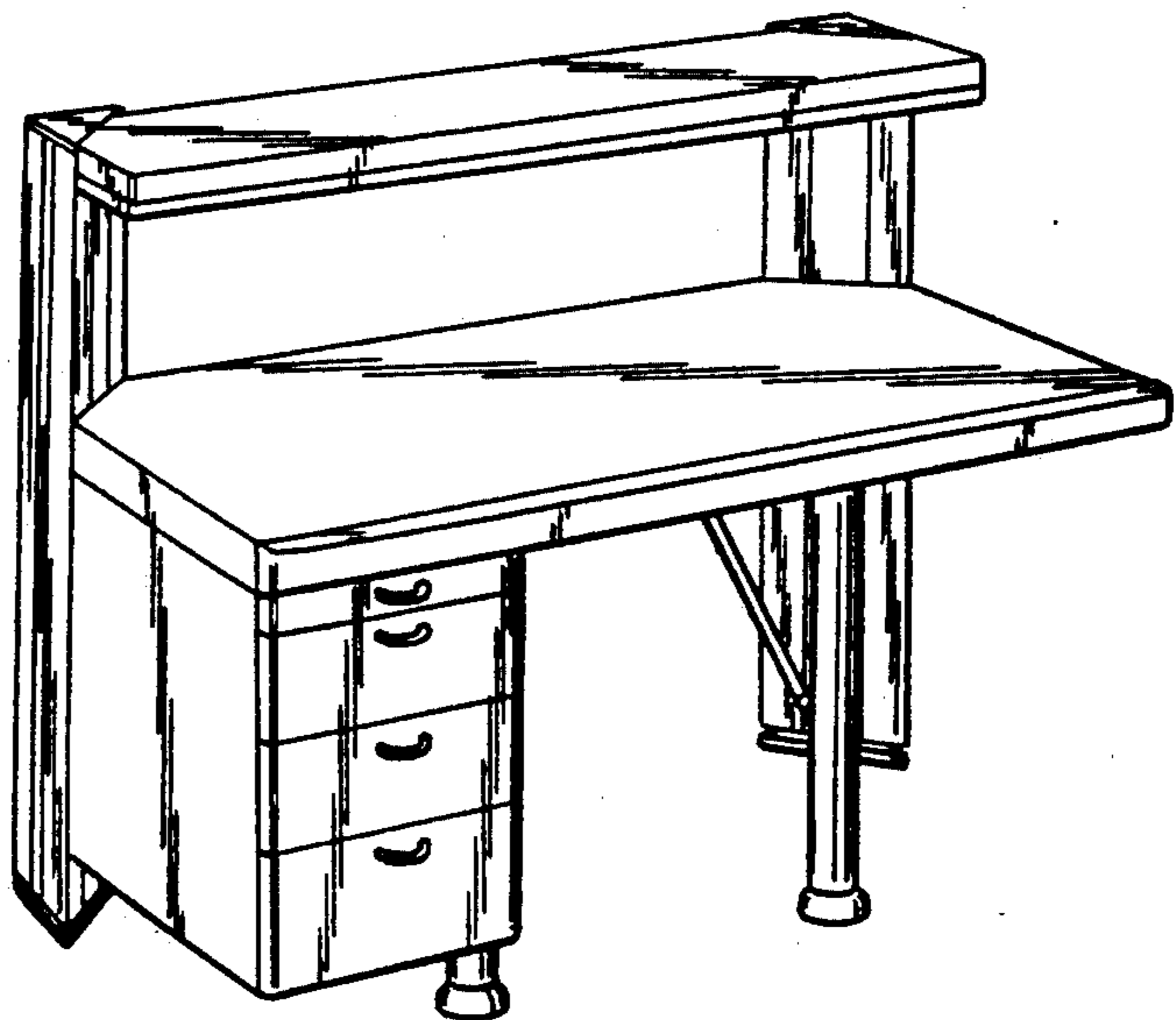

FIG. 21.



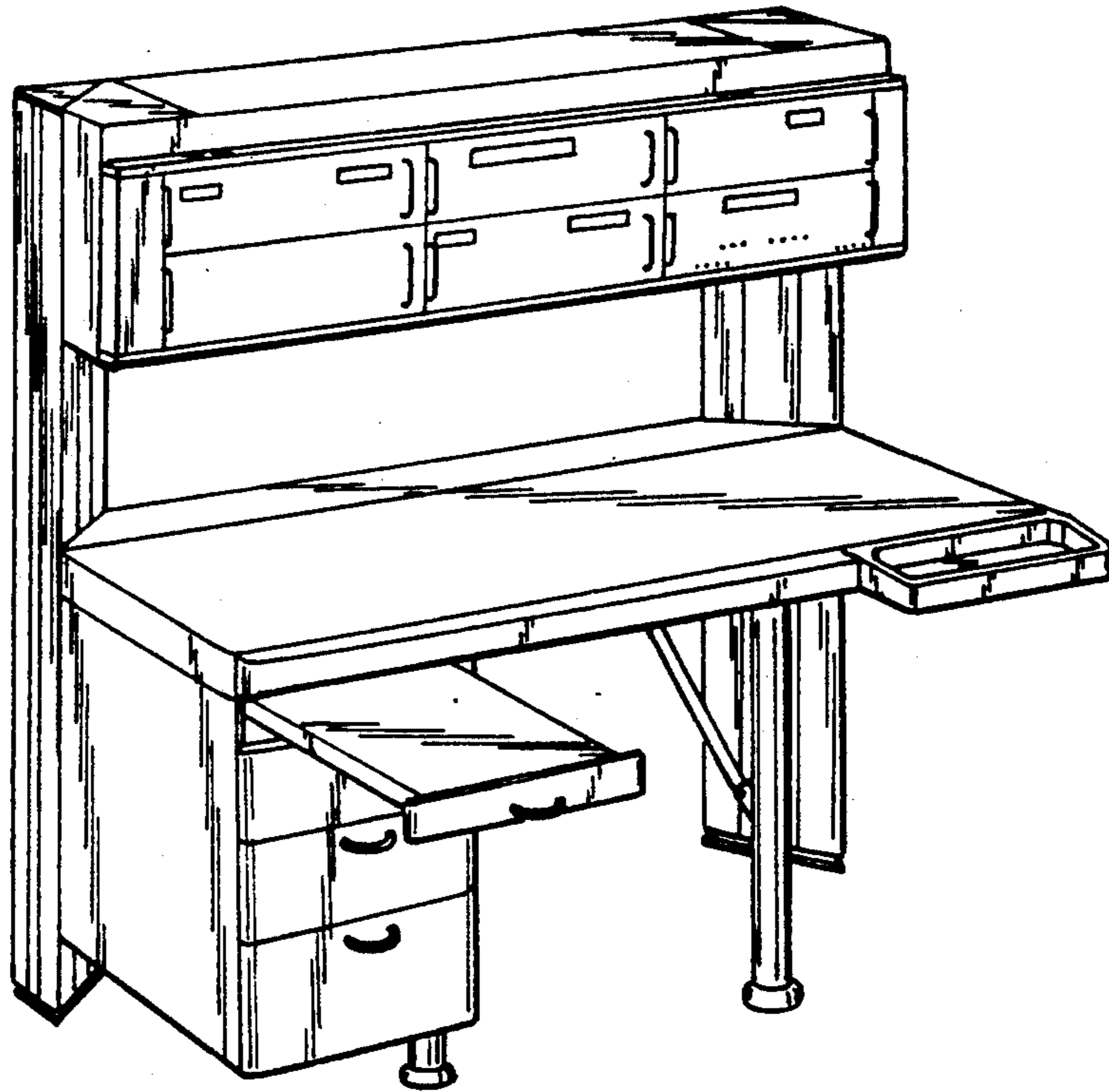

FIG. 22.

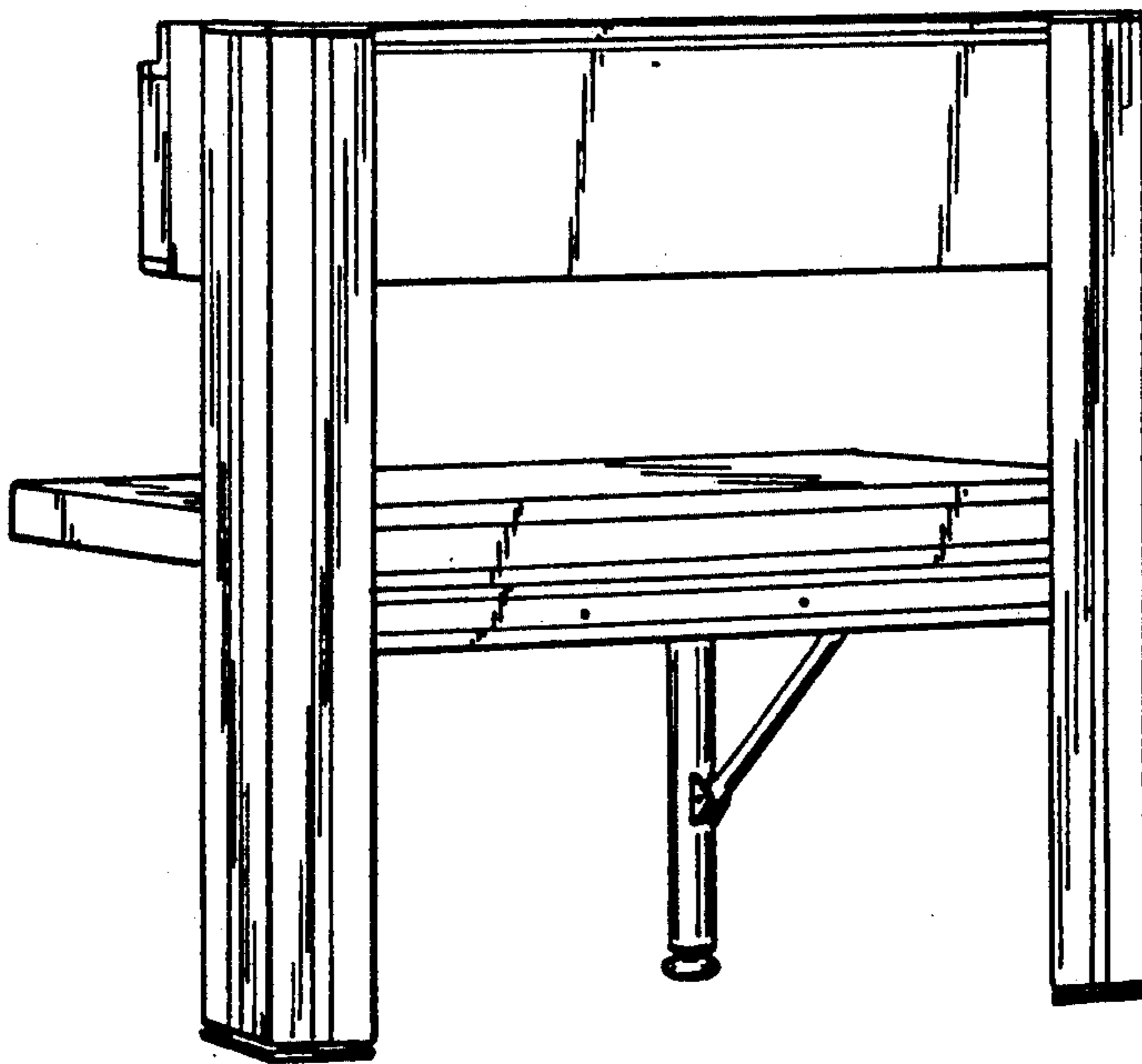

FIG. 23.