



US00D330837S

United States Patent [19]

Harmon

[11] Patent Number: **Des. 330,837**

[45] Date of Patent: **** Nov. 10, 1992**

[54] **HANDLE GUARD**

[76] Inventor: **Donald W. Harmon, 34335 Mulholland Hwy., Malibu, Calif. 90265**

[**] Term: **14 Years**

[21] Appl. No.: **463,671**

[22] Filed: **Jan. 9, 1990**

[52] U.S. Cl. **D8/80**

[58] Field of Search **D8/14, 107, 80; 81/20, 81/489; 254/25, 26; D21/222; 273/73 J, 75**

4,961,572 10/1990 Badillo et al. D21/222
4,964,192 10/1990 Marui 81/489

OTHER PUBLICATIONS

Proto Tools Cat., 1980, Hammer Handles.

Primary Examiner—Bernard Ansher

Assistant Examiner—Philip Hyder

[57] **CLAIM**

The ornamental design for the handle guard, as shown and described.

DESCRIPTION

FIG. 1 is a perspective view of a handle guard showing my new design; the broken line showing of the hammer being for illustrative purposes only and forming no part of the claimed design;

FIG. 2 is a left side elevational view thereof, the right side being a mirror image;

FIG. 3 is a front elevational view thereof;

FIG. 4 is a rear elevational view thereof;

FIG. 5 is a top plan view thereof; and,

FIG. 6 is a bottom plan view thereof.

[56] **References Cited**

U.S. PATENT DOCUMENTS

D. 196,268	5/1962	Lamb	D8/107
D. 240,367	6/1976	Cope	D21/222
D. 258,413	3/1981	Adams	D8/80
D. 280,756	9/1985	Kaner	D21/222
1,532,822	4/1925	Kemp	D8/80
3,792,725	2/1974	Burgeson	81/20
4,098,506	7/1978	Gaiser	273/75

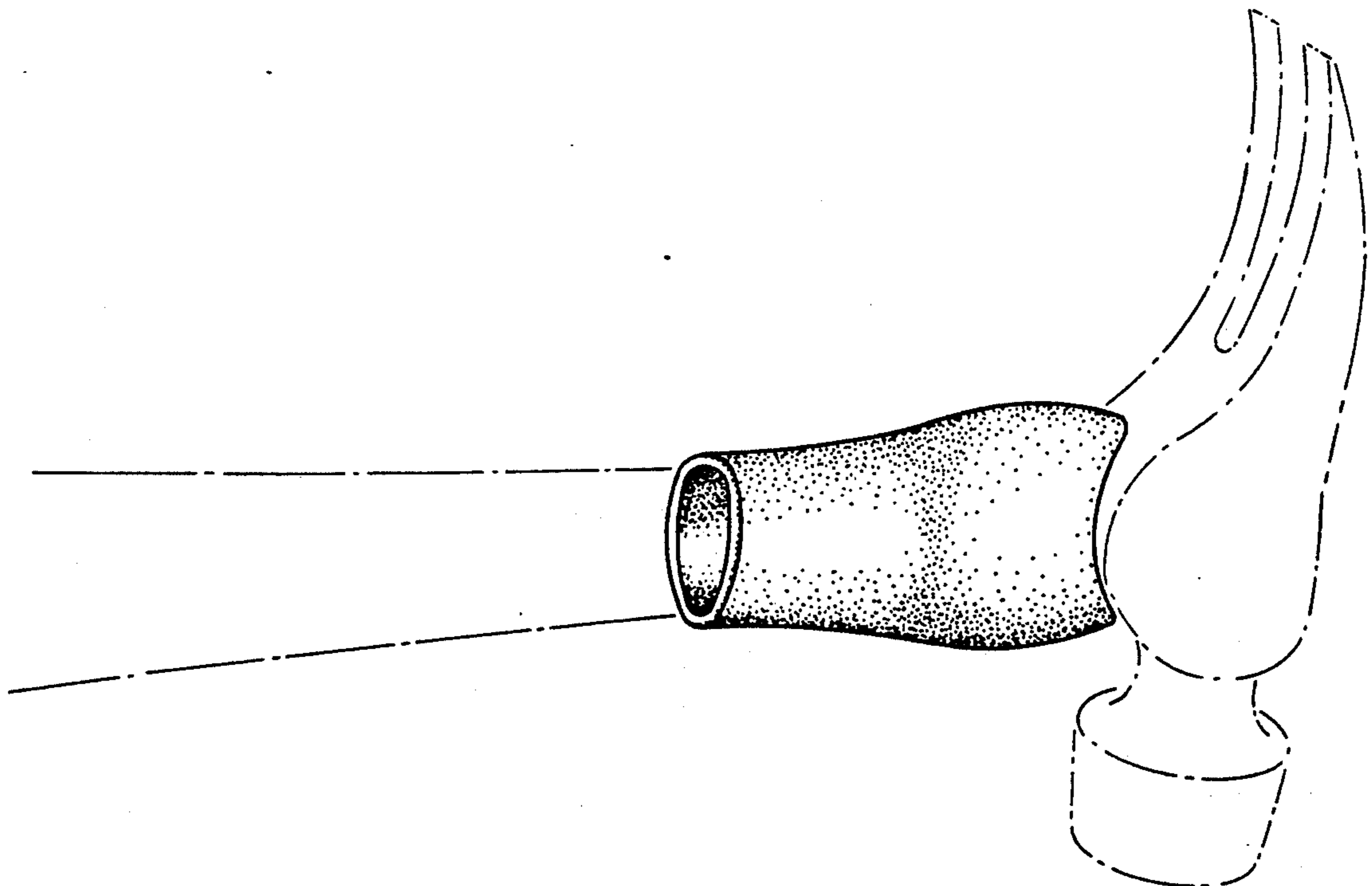

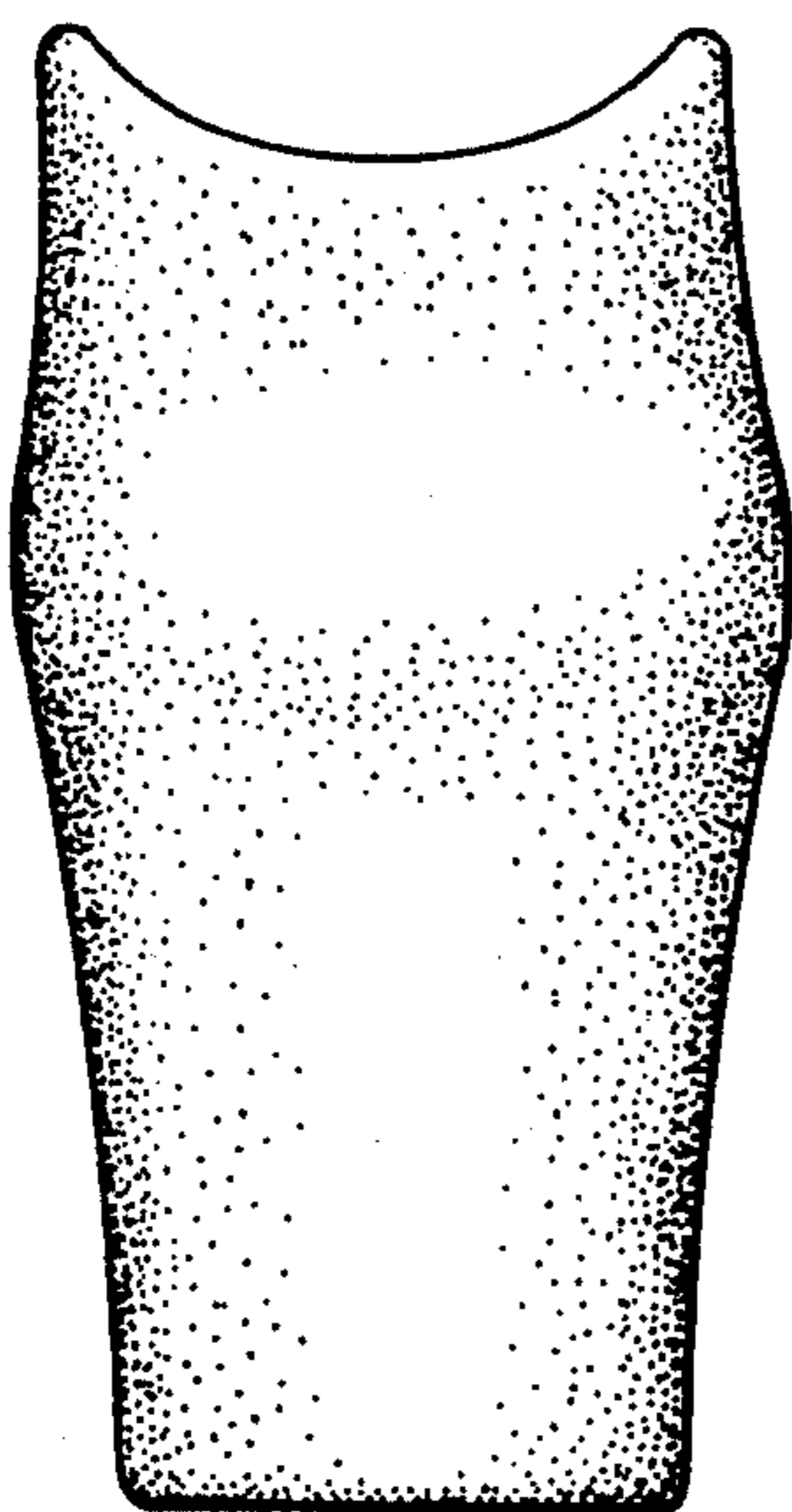
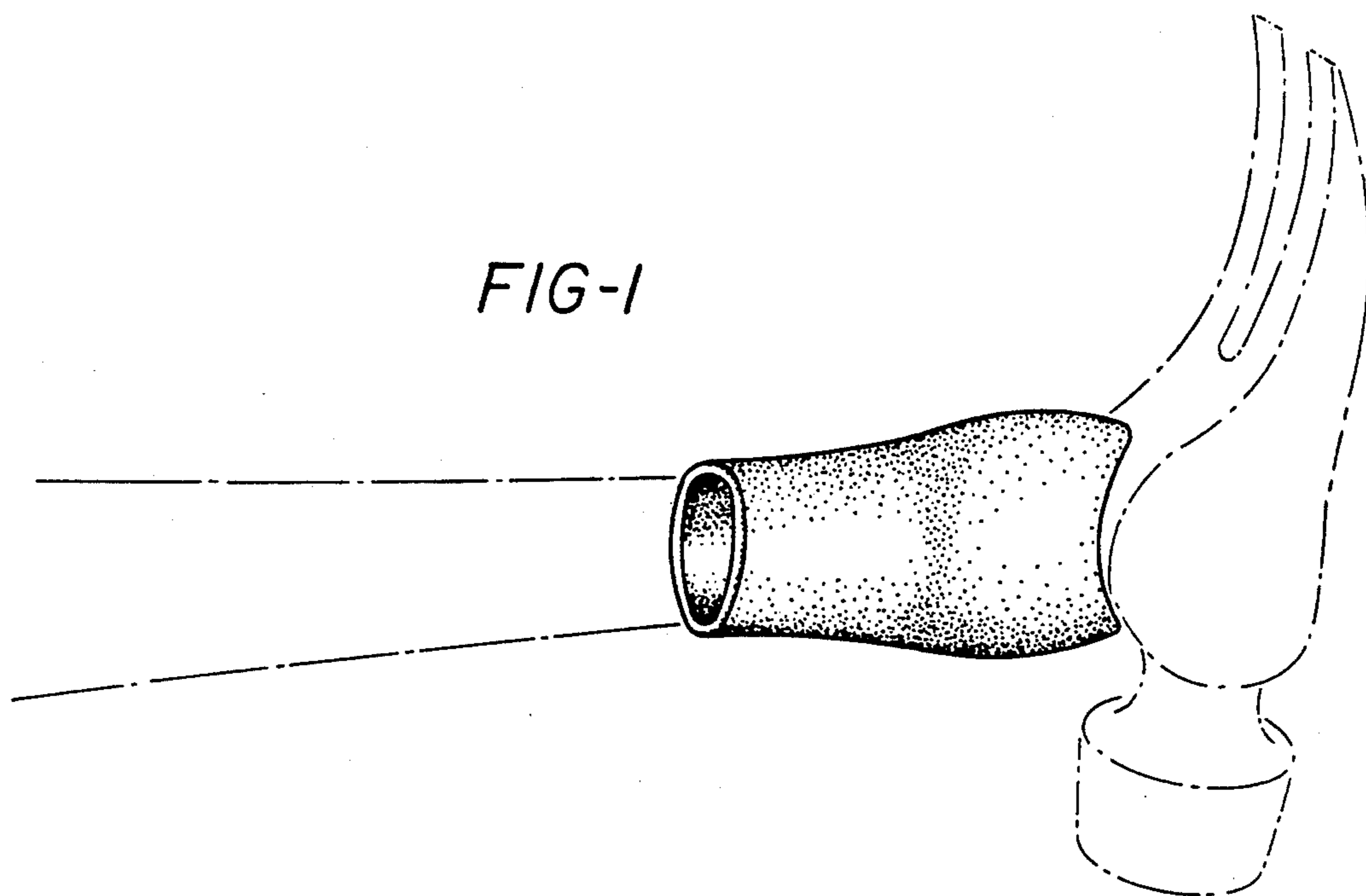

FIG-2

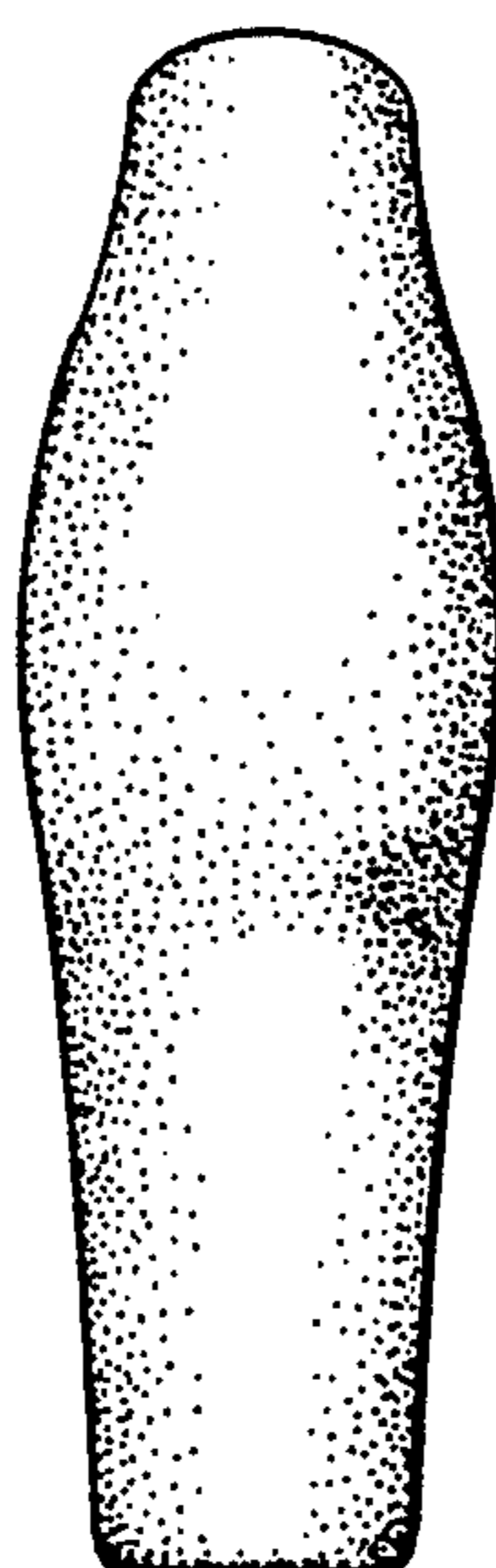

FIG-3

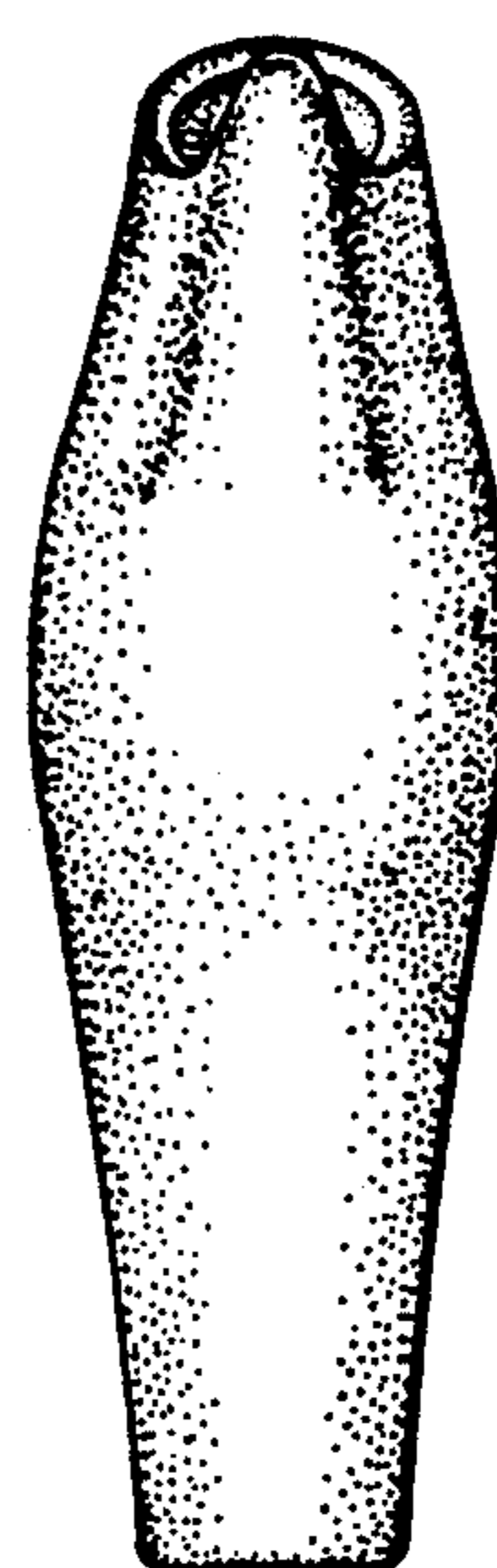

FIG-4

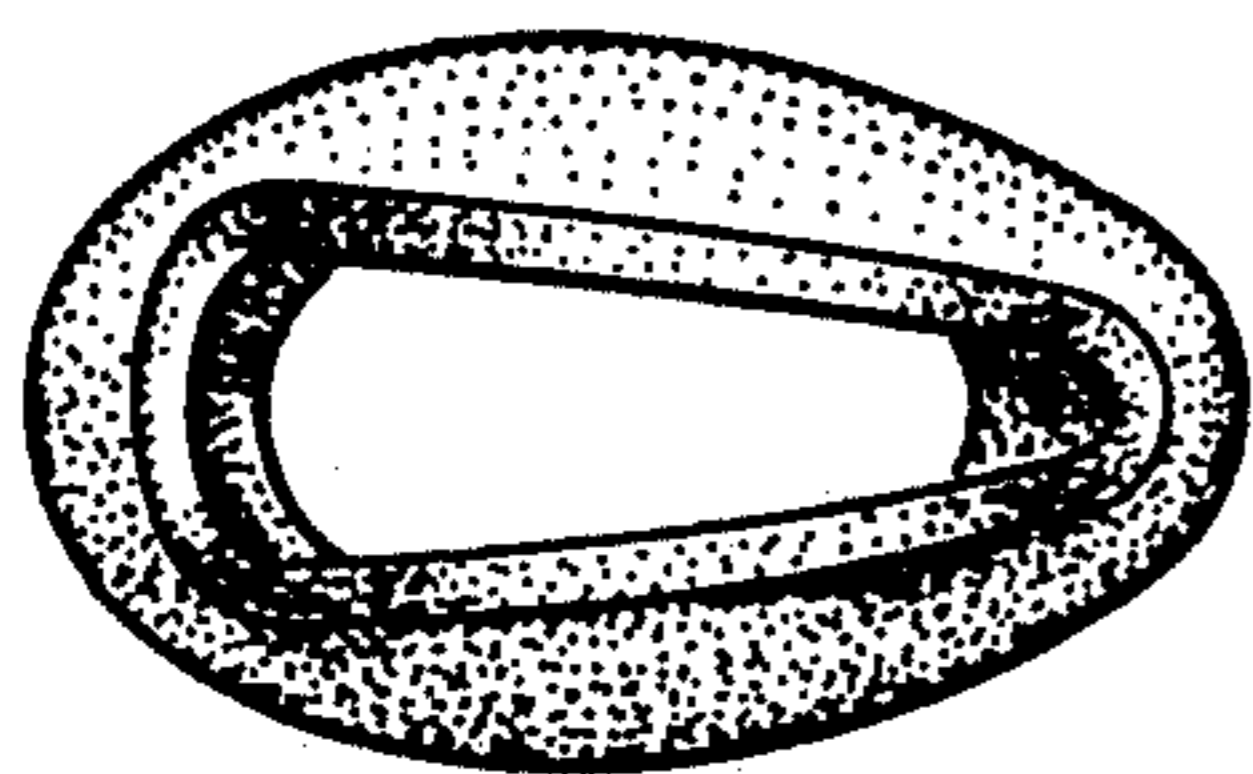

FIG-5

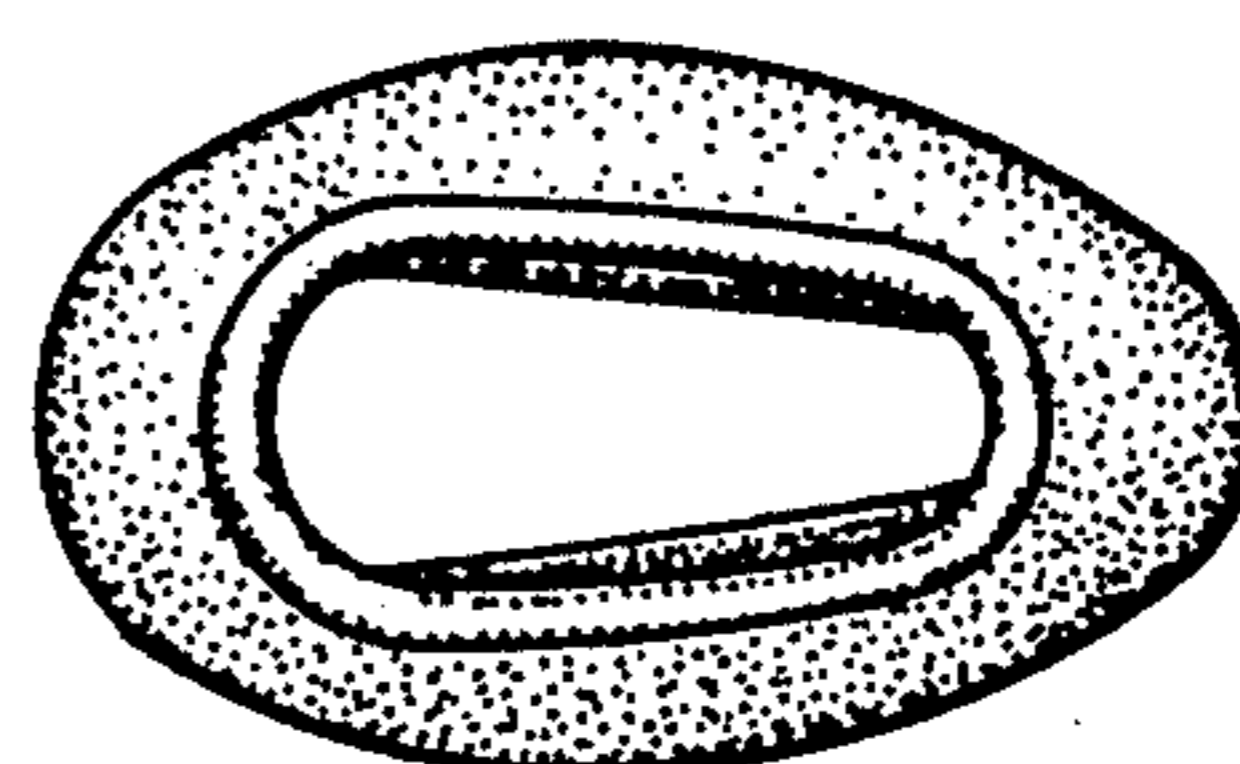

FIG-6