



US00D330659S

United States Patent [19]

[11] Patent Number: **Des. 330,659**

Vones

[45] Date of Patent: **** Nov. 3, 1992**

[54] **PROTECTIVE SHADE FOR USE
PRIMARILY BY A SUNTANNER**

[76] Inventor: **Frank E. Vones, 17 Vones La.,
Bridgewater, N.J. 08807**

[**] Term: **14 Years**

[21] Appl. No.: **394,513**

[22] Filed: **Aug. 16, 1989**

[52] U.S. Cl. **D6/575**

[58] Field of Search **D6/575-580;
D25/49; 160/254, 238**

[56] **References Cited**

U.S. PATENT DOCUMENTS

D. 29,953	1/1899	Burrowes	D6/575
1,219,312	3/1917	Howe	160/254
1,311,372	7/1919	Barnum	160/254
1,392,512	10/1921	McCloskey	160/254
1,997,484	4/1935	Collins	D6/576 X
2,317,452	4/1943	Goodloe	160/254
2,943,965	7/1960	Stogre	160/238 X
3,092,174	6/1963	Winn	D6/575 X

4,428,218 1/1984 La Rocca D25/49 X

Primary Examiner—Nelson C. Holtje
Assistant Examiner—Janice E. Seeger
Attorney, Agent, or Firm—Leon Gilden

[57] **CLAIM**

The ornamental design for a protective shade for use primarily by a suntanner, as shown and described.

DESCRIPTION

FIG. 1 is a front elevational view of a protective shade for use primarily by a suntanner showing my new design;
FIG. 2 is a rear elevational view thereof;
FIG. 3 is a left side elevational view thereof;
FIG. 4 is a right side elevational view thereof;
FIG. 5 is a top plan views thereof;
FIG. 6 is a bottom plan view thereof; and,
FIG. 7 is a perspective view thereof.
FIGS. 1, 2, 5 and 6 are shown broken away whereby to indicate indeterminate length.
FIGS. 5-7 show the shade in partially extended condition.

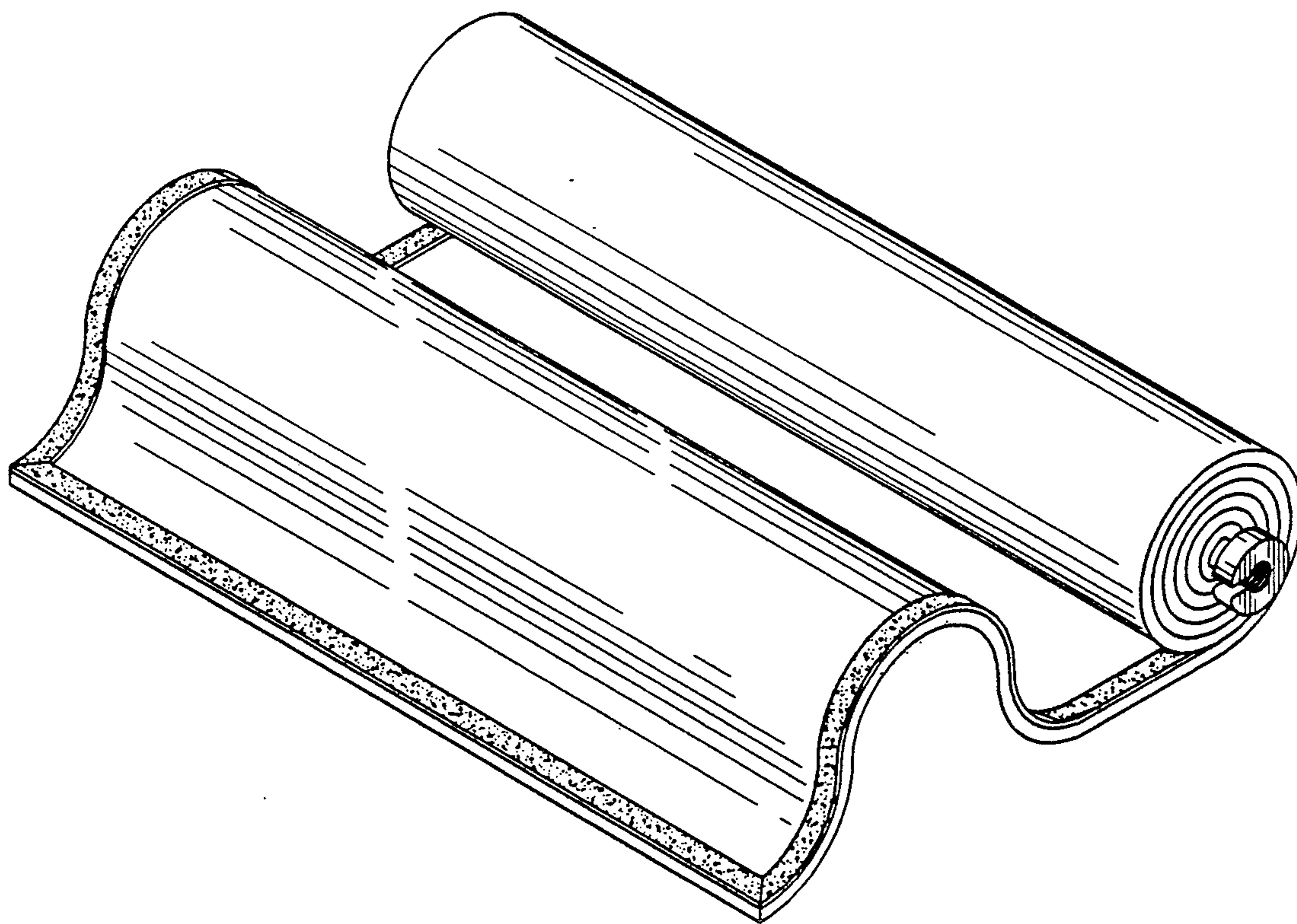

FIG. 1

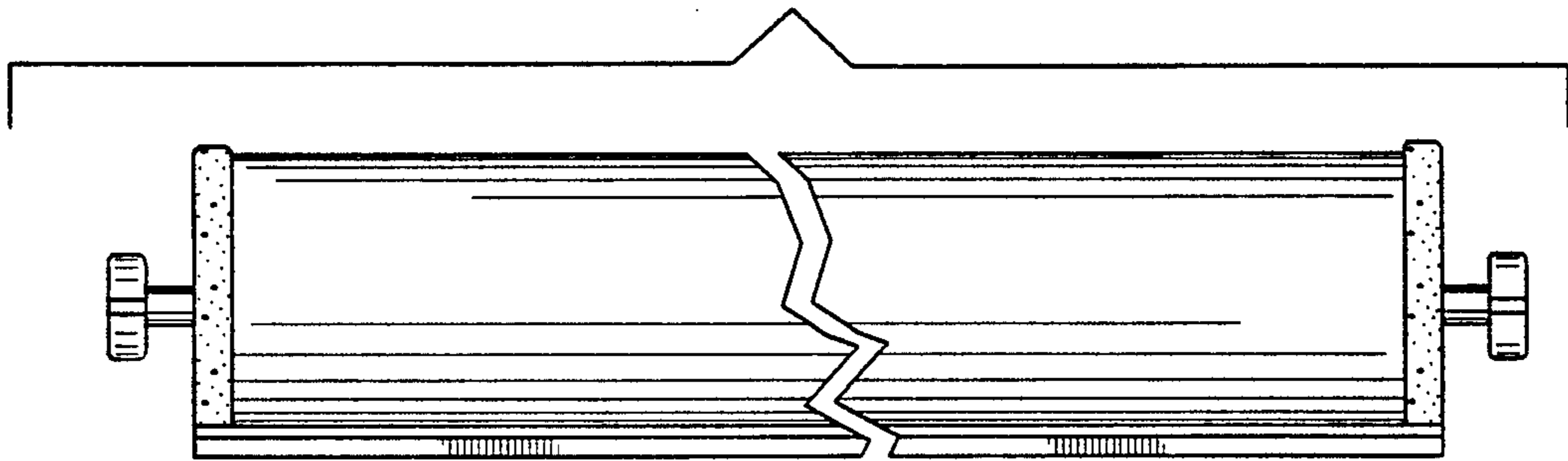

FIG. 2

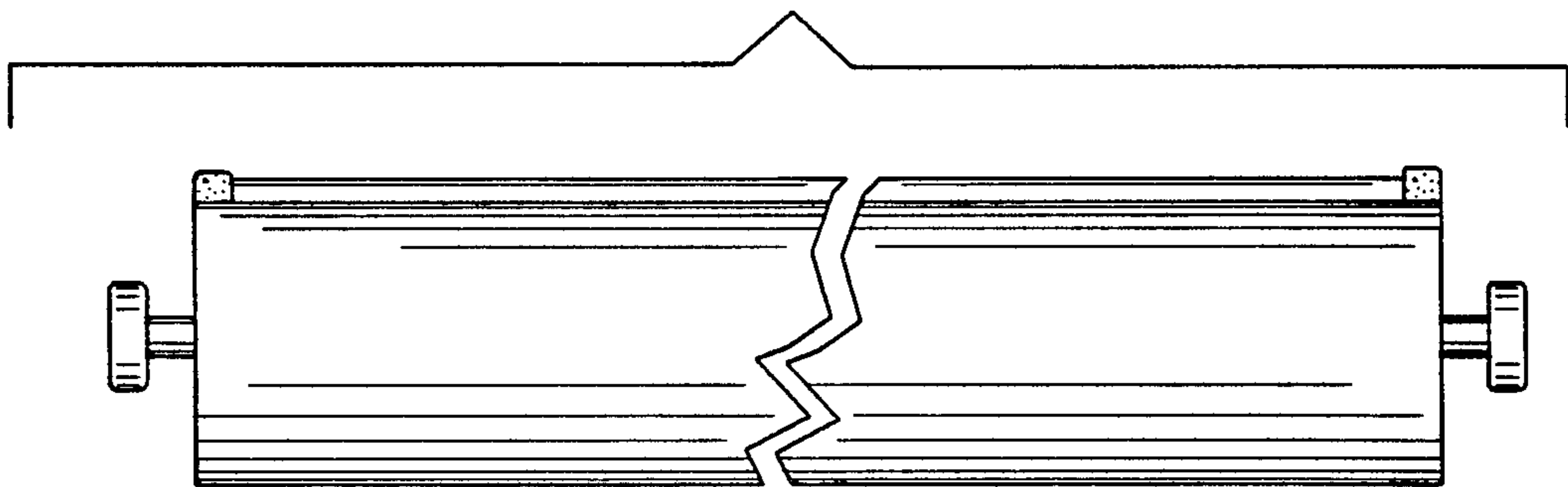

FIG. 3

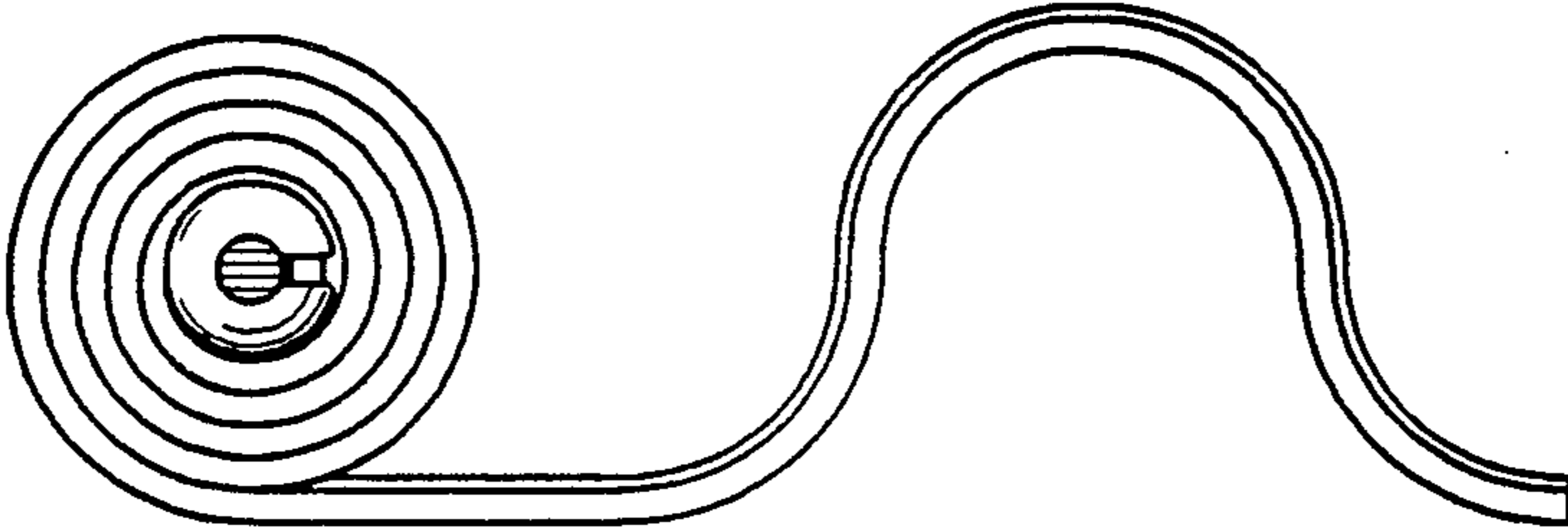

FIG. 4

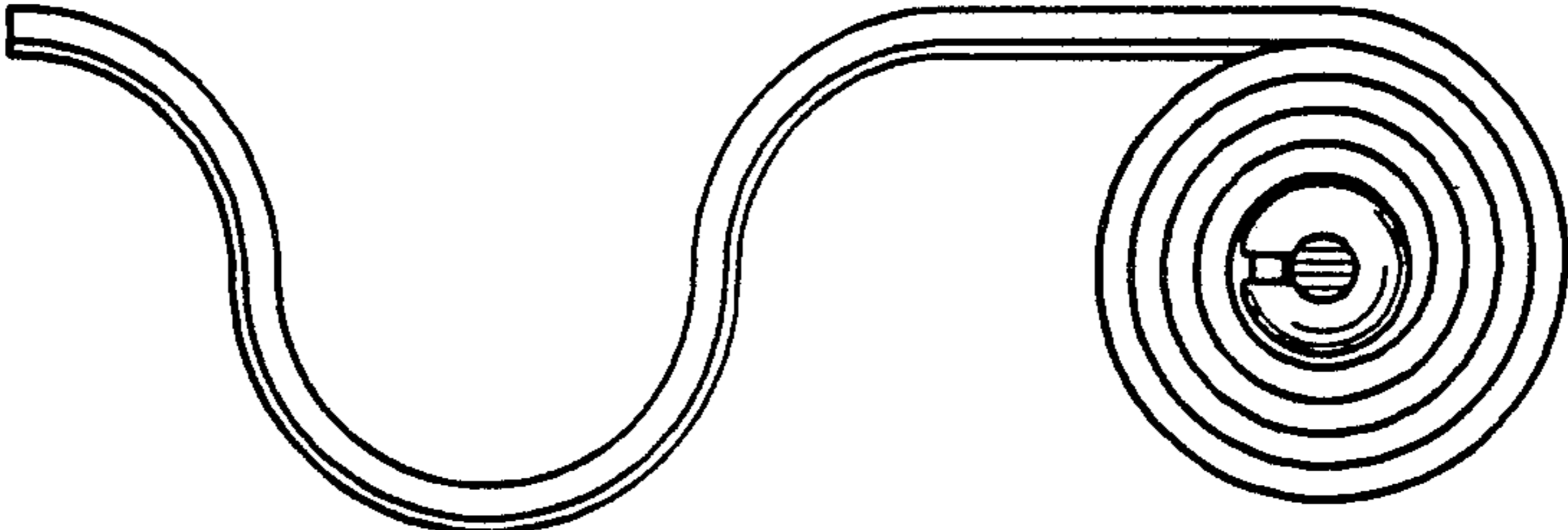

FIG. 5

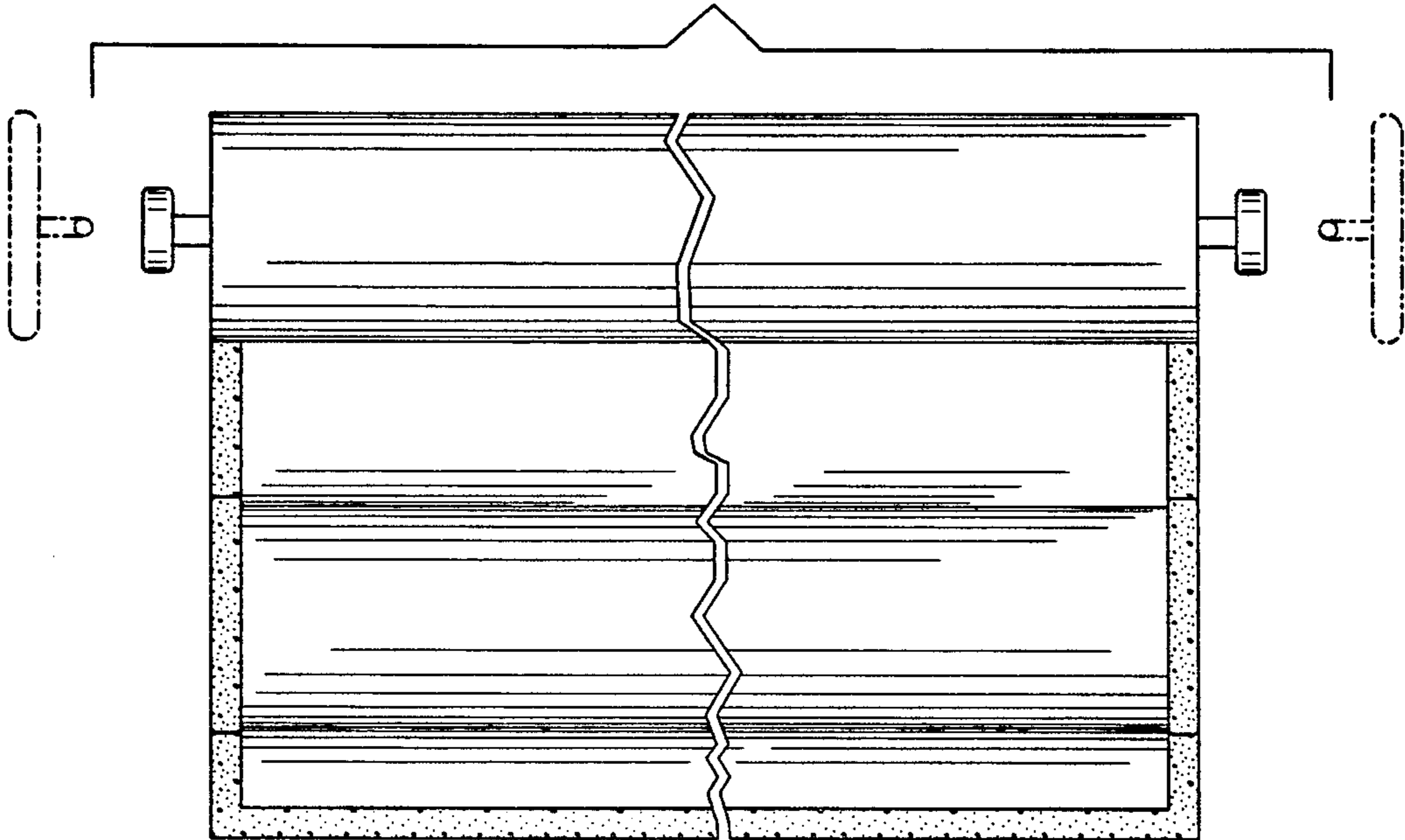

FIG. 6

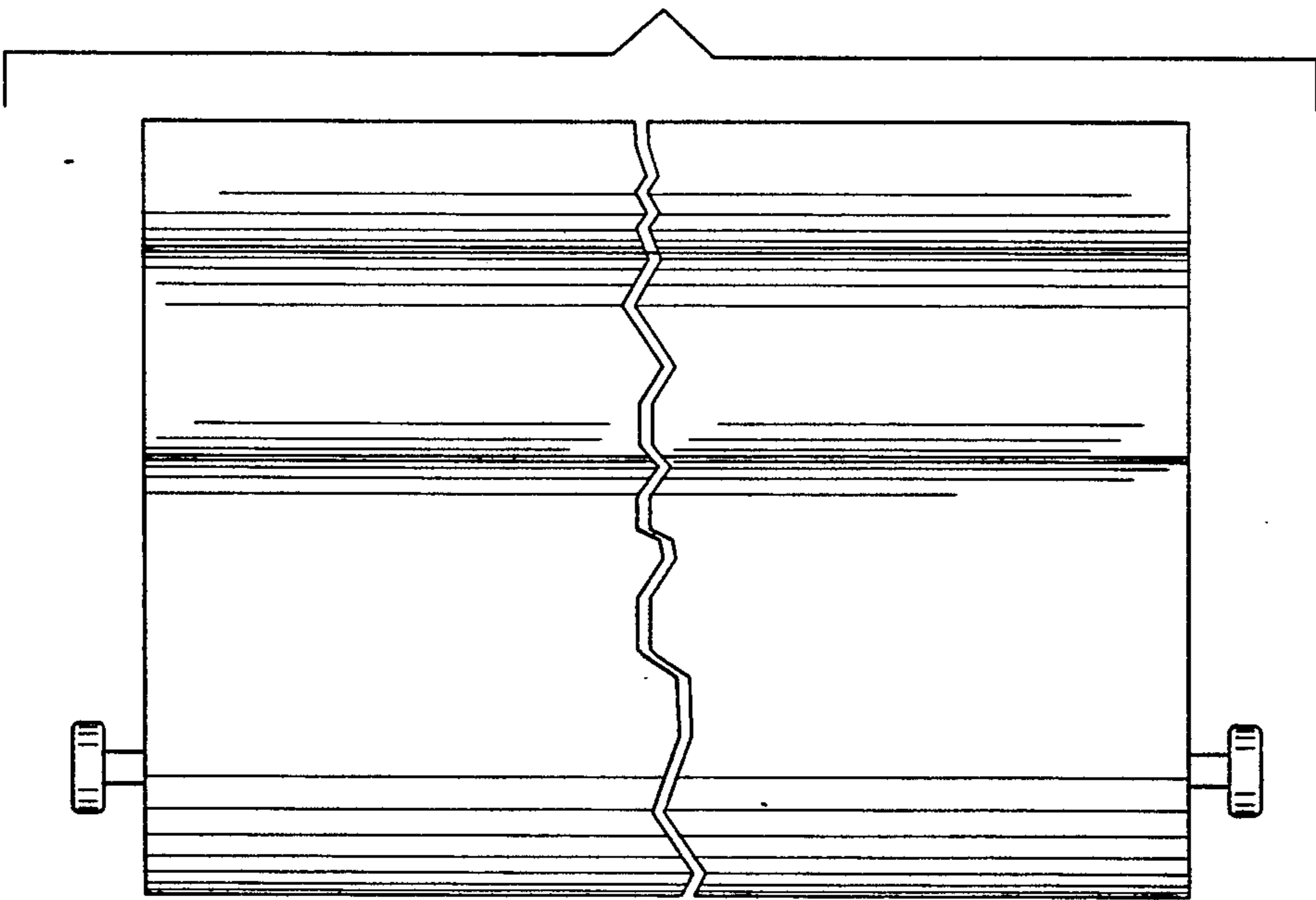

FIG. 7

