



US00D330650S

United States Patent [19]

[11] Patent Number: **Des. 330,650**

Staubitz et al.

[45] Date of Patent: **** Nov. 3, 1992**

[54] **DISPLAY RACK**

[75] Inventors: **Robert B. Staubitz**, Collinsville;
Kenneth D. Harris, Jr., Winstead;
Timothy C. Repp, Avon, all of Conn.

[73] Assignee: **Ingersoll-Rand Company**, Woodcliff Lake, N.J.

[**] Term: **14 Years**

[21] Appl. No.: **646,327**

[22] Filed: **Jan. 28, 1991**

[52] U.S. Cl. **D6/467**

[58] Field of Search **D6/449, 466-469, D6/475, 476; D34/40, 42, 46; D9/341, 342, 455, 457; D8/71; D19/75, 78, 85; 211/13, 69, 69.5, 70.6**

[56] **References Cited**

U.S. PATENT DOCUMENTS

- D. 209,642 12/1967 Goldberg D6/476 X
- D. 269,836 7/1983 Pruzan D6/467

- D. 282,579 2/1986 Juergens D6/469 X
- D. 289,863 5/1987 Pecoff D6/469 X
- D. 291,513 8/1987 Gingher, Jr. D6/467
- D. 303,447 9/1989 Ayres D34/42
- D. 320,619 10/1991 Schleeh D19/85 X
- D. 323,441 1/1992 Waldeck D6/476 X
- D. 323,782 2/1992 McQuarrie D9/341 X

Primary Examiner—Nelson C. Holtje
Assistant Examiner—Jeffrey Asch
Attorney, Agent, or Firm—Walter C. Vliet

[57] CLAIM

The ornamental design for a display rack, as shown and described.

DESCRIPTION

FIG. 1 is a front elevational view of a display rack showing our design;
FIG. 2 is a top plan view;
FIG. 3 is a rear elevational view;
FIG. 4 is a bottom plan view;
FIG. 5 is a left side elevational view; and,
FIG. 6 is a right side elevational view thereof.

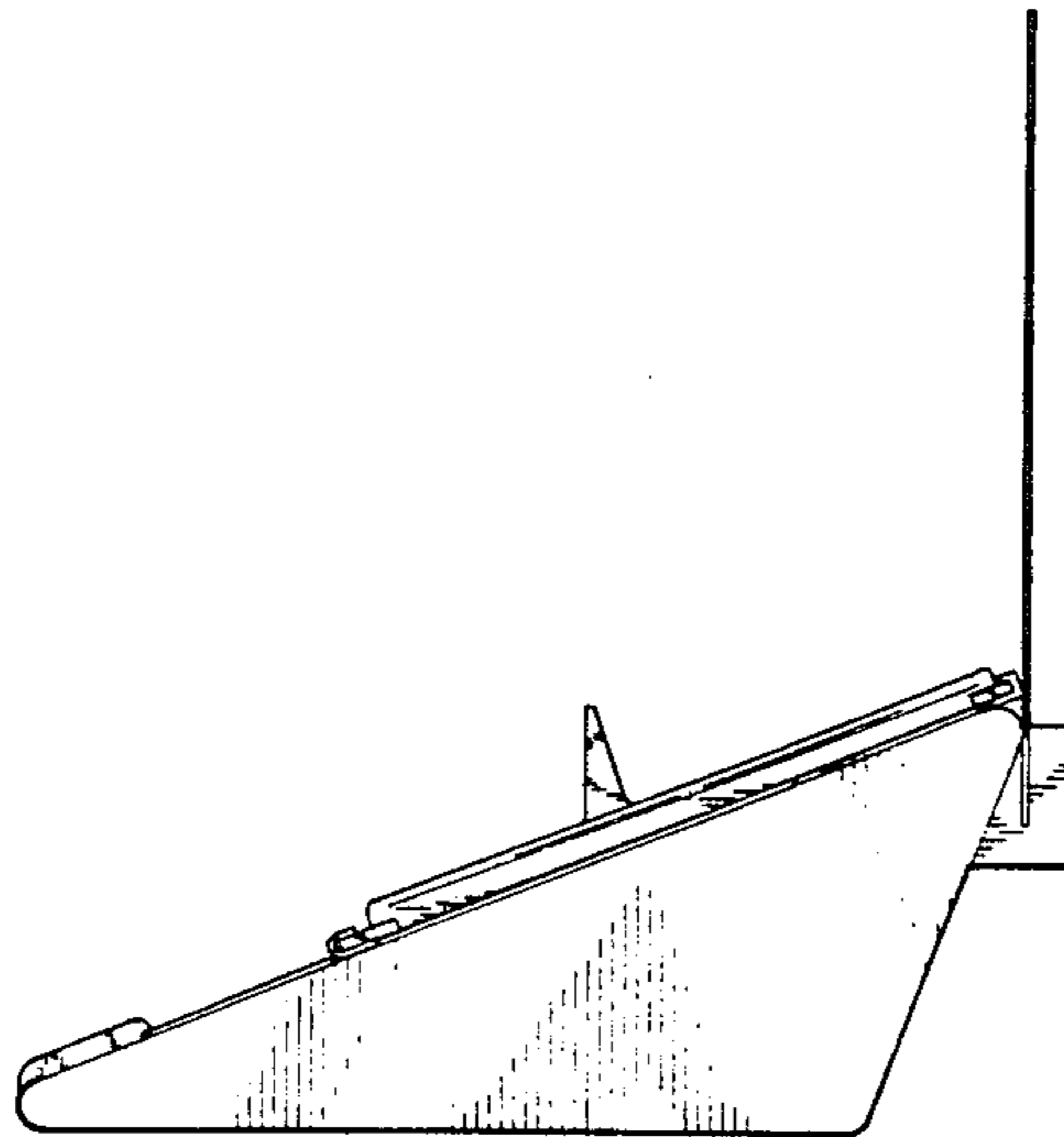
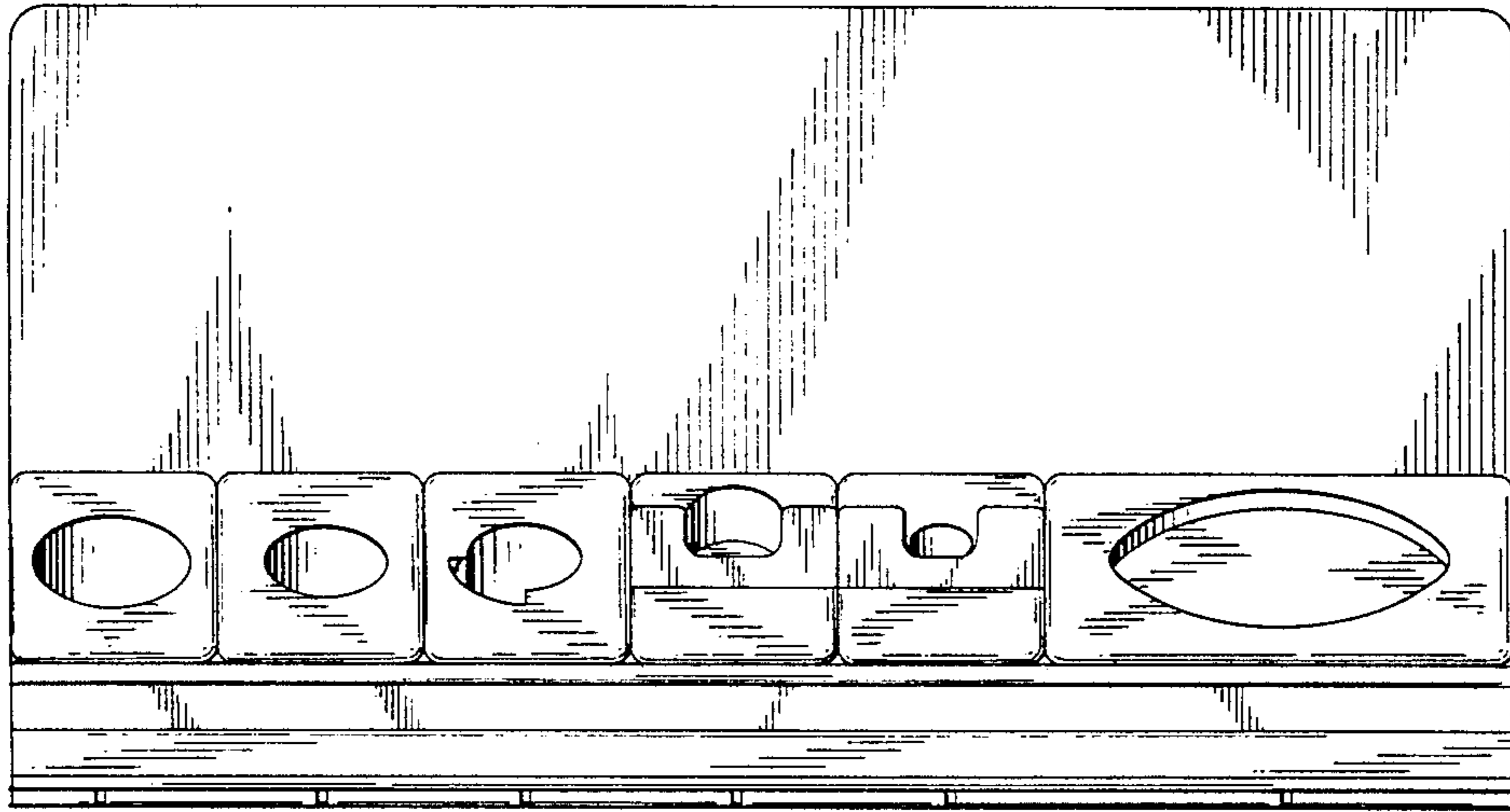

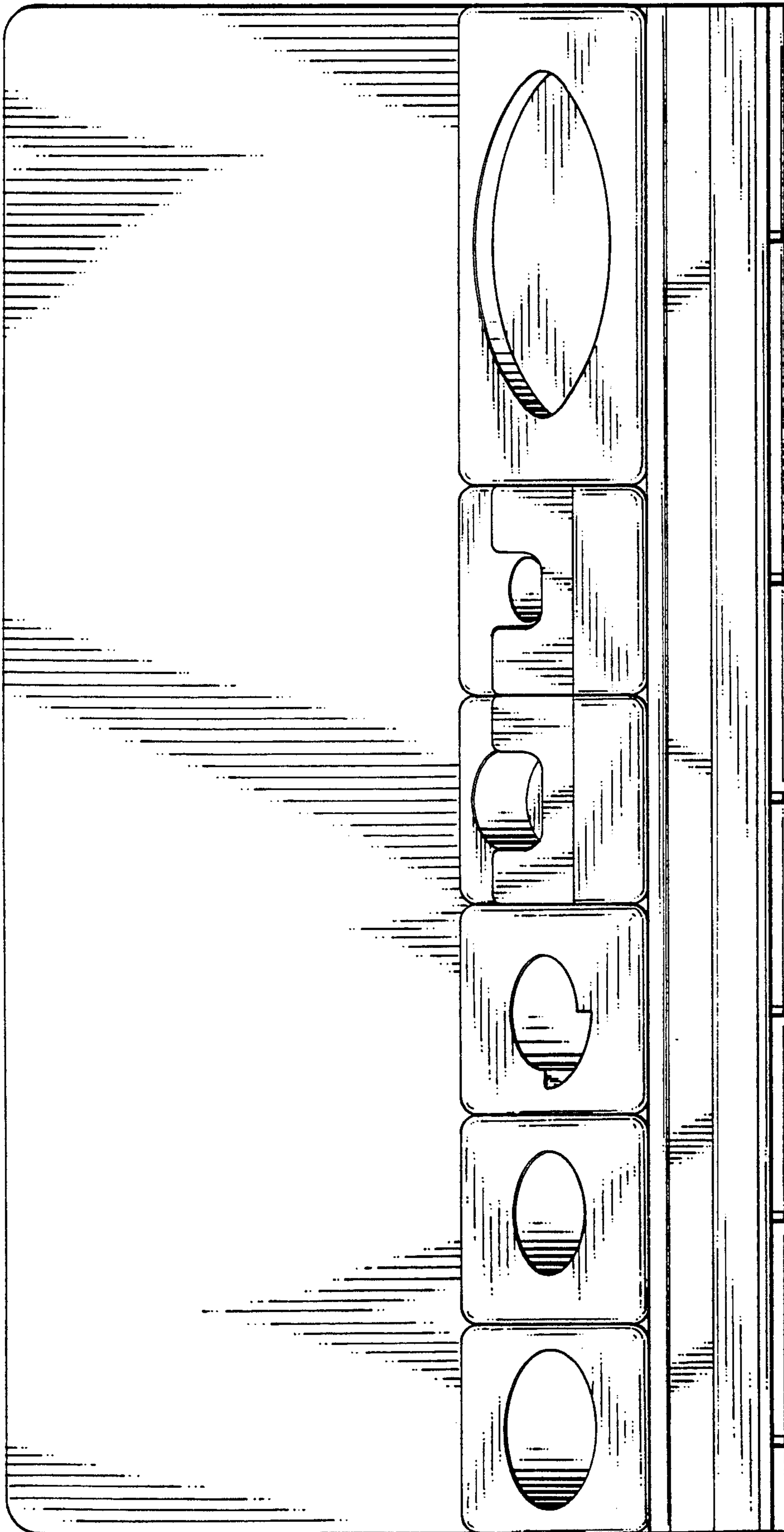

FIG. 1

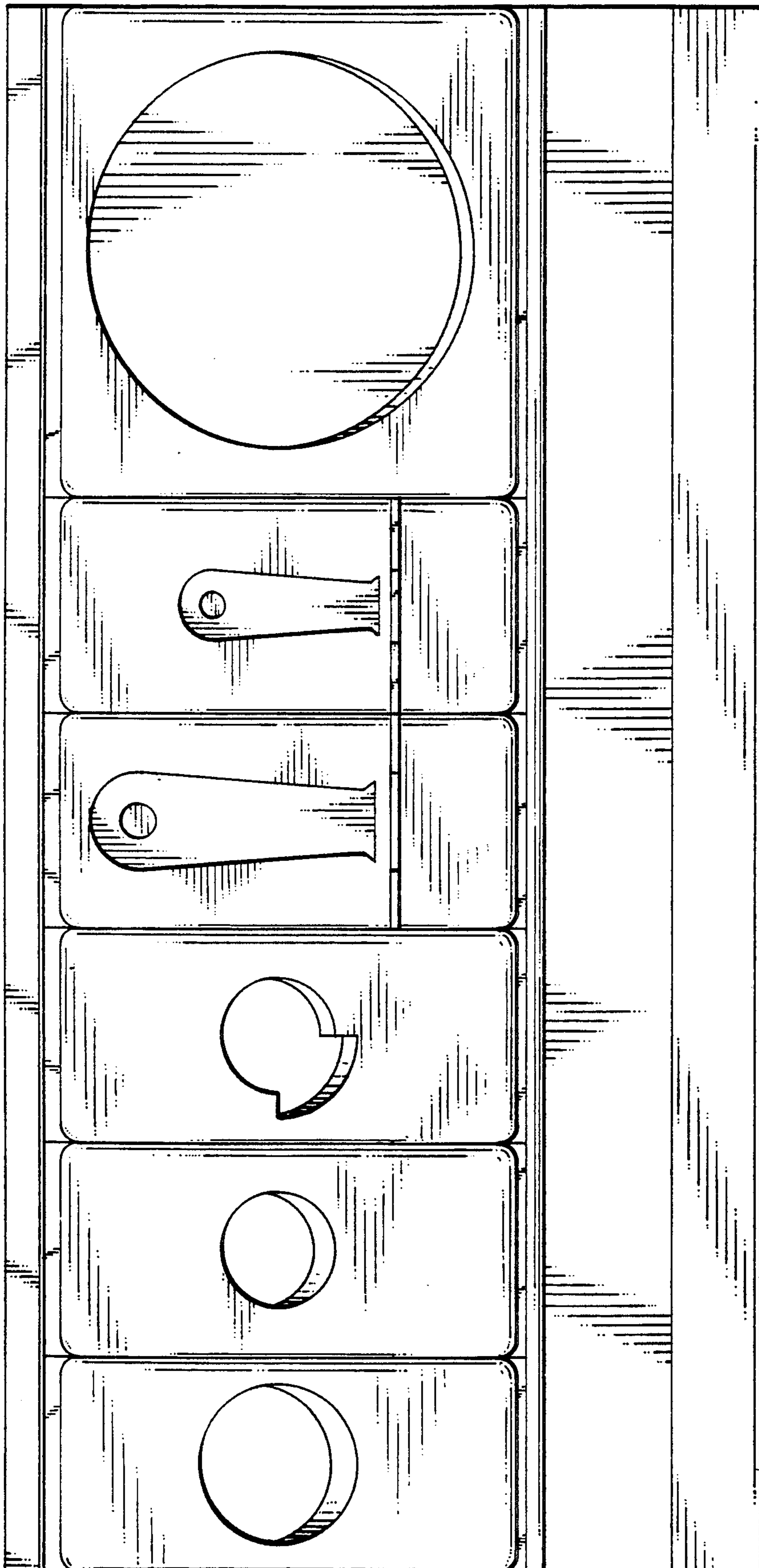

FIG. 2

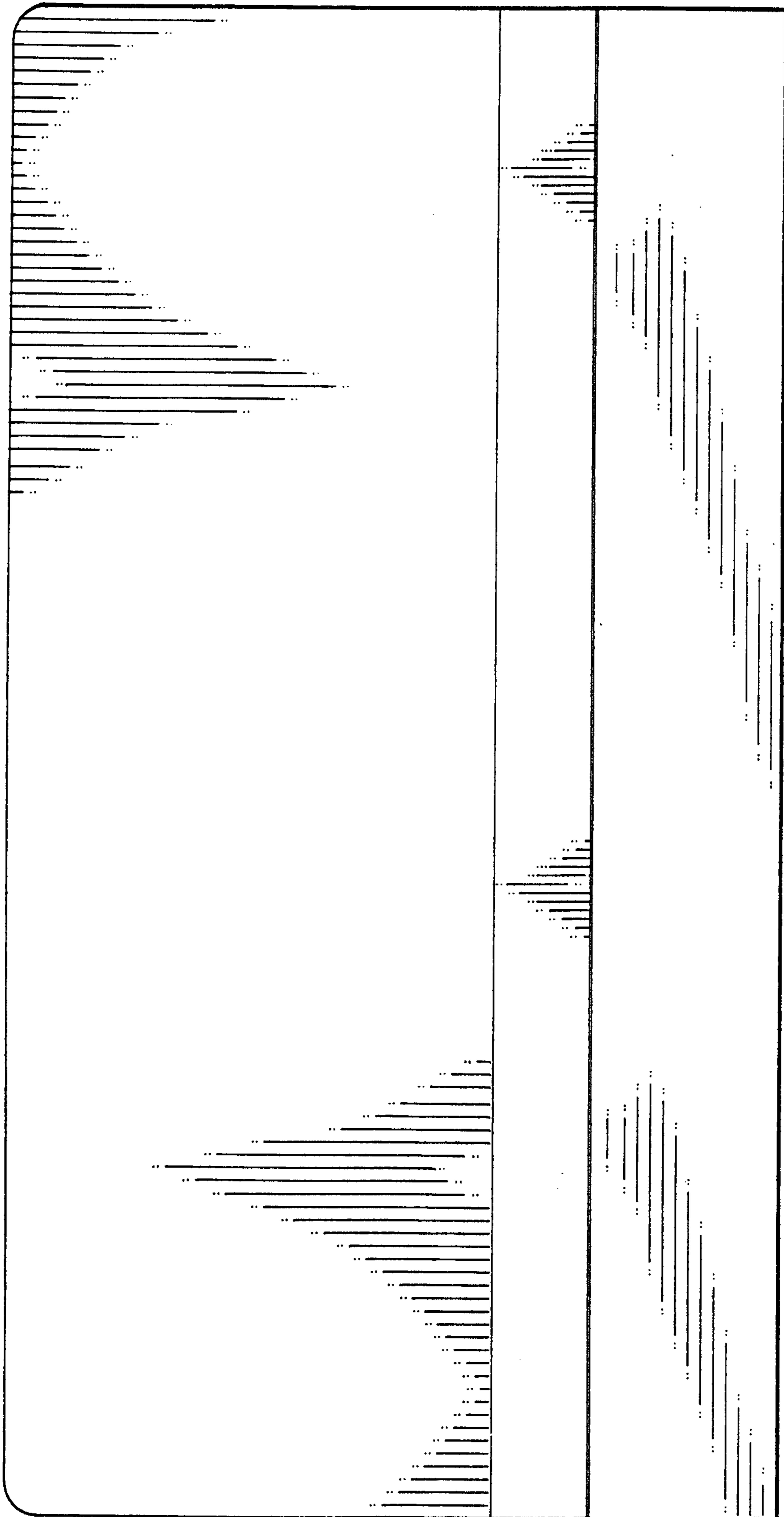

FIG. 3

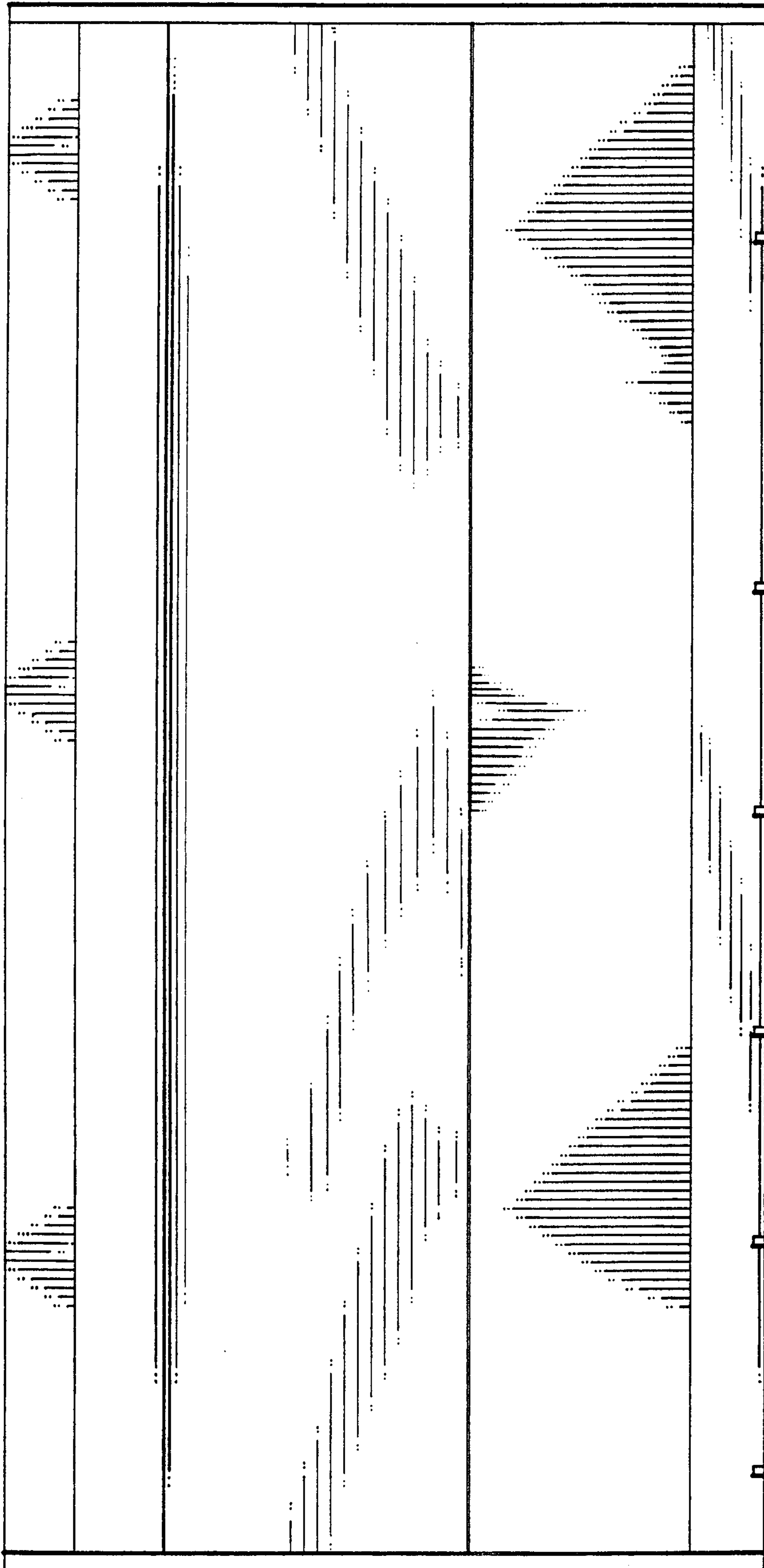

FIG. 4

FIG. 5

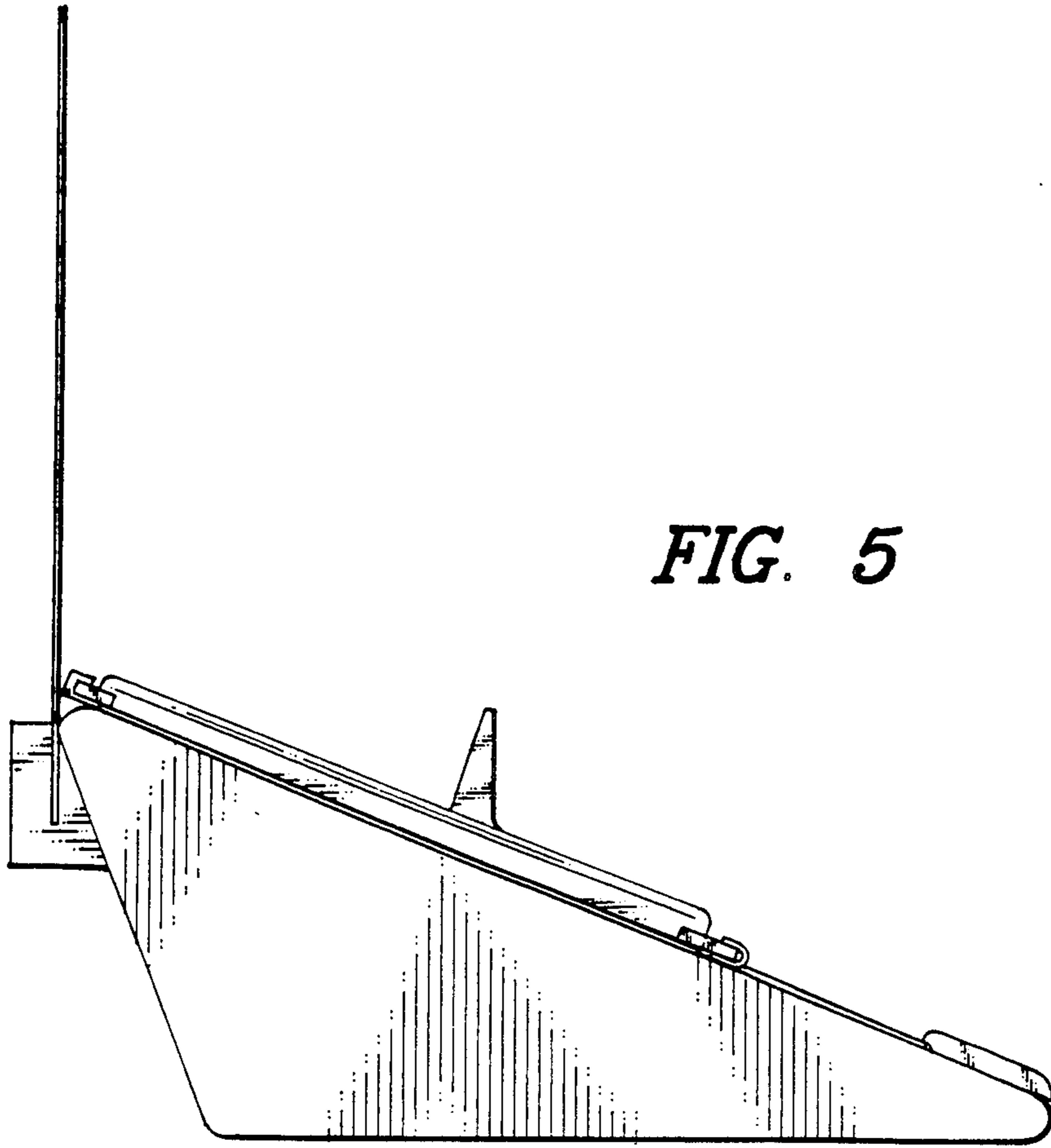

FIG. 6

