



US00D330606S

United States Patent [19]

[11] Patent Number: **Des. 330,606**

Lee

[45] Date of Patent: **** Oct. 27, 1992**

[54] **ADJUSTABLE LAMP**

[76] Inventor: **Stanley Lee**, No. 3, Lane 645,
Ta-Tong Rd., Pei-Kan Chen,
Yun-Lin Hsien, Taiwan

[**] Term: **14 Years**

[21] Appl. No.: **672,606**

[22] Filed: **Mar. 20, 1991**

[52] U.S. Cl. **D26/63; D26/64**

[58] Field of Search **D26/60-66;**
362/269, 277, 285, 413, 418, 419, 427, 401, 402

[56] **References Cited**

U.S. PATENT DOCUMENTS

D. 165,806	1/1952	Watrous	D26/63
D. 207,734	5/1967	Fralick	D26/64
2,299,683	10/1942	Curtis	362/413 X
3,382,356	5/1968	Eyth	D26/64 X

FOREIGN PATENT DOCUMENTS

798713 3/1936 France 362/419

Primary Examiner—Susan J. Lucas
Attorney, Agent, or Firm—Bacon & Thomas

[57] **CLAIM**

The ornamental design for an adjustable lamp, as shown and described.

DESCRIPTION

FIG. 1 is a front perspective view of an adjustable lamp showing my new design;
FIG. 2 is a front elevational view thereof;
FIG. 3 is a rear elevational view thereof;
FIG. 4 is a left side elevational view thereof;
FIG. 5 is a right side elevational view thereof;
FIG. 6 is a top plan view thereof; and,
FIG. 7 is a bottom plan view thereof.

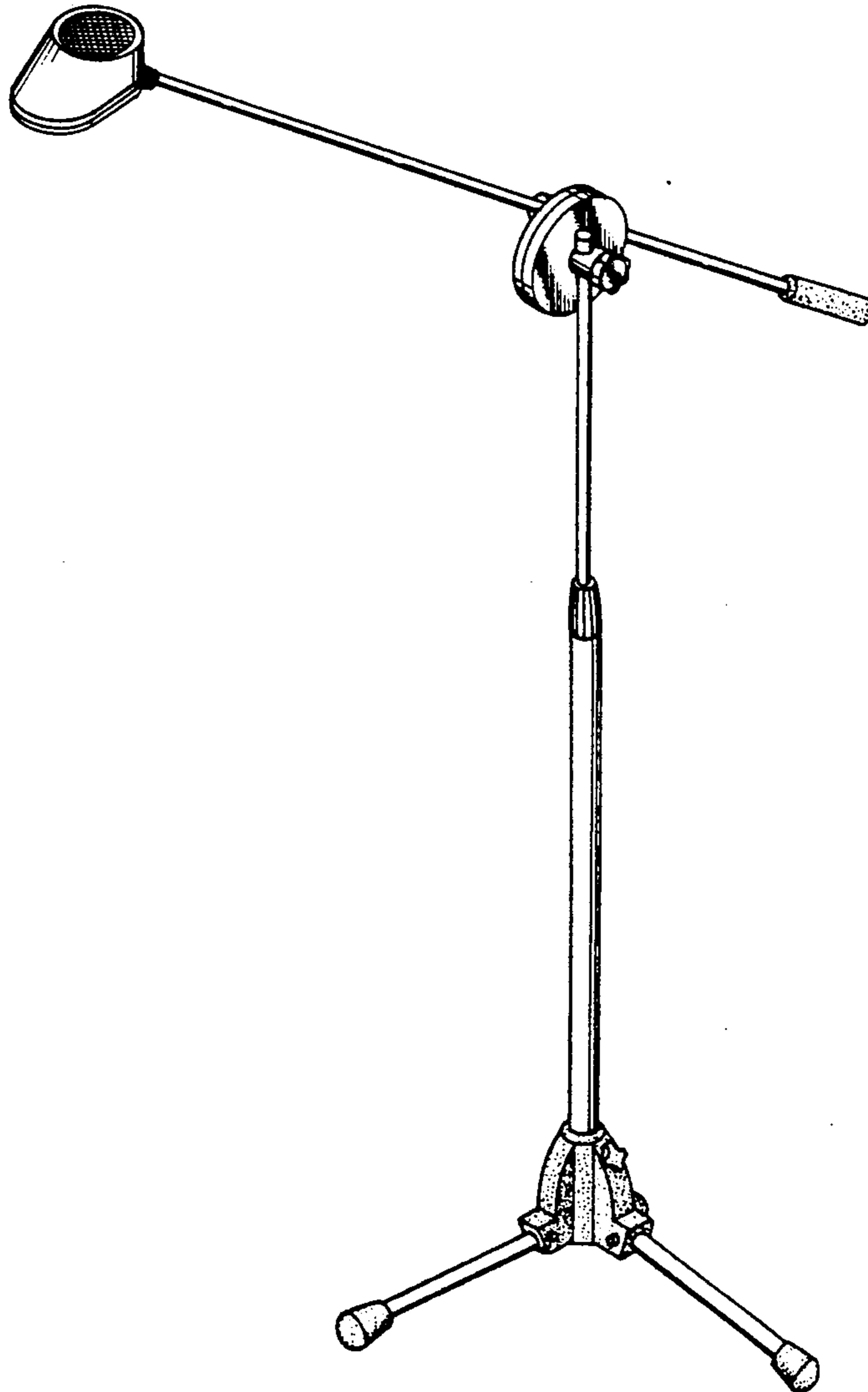

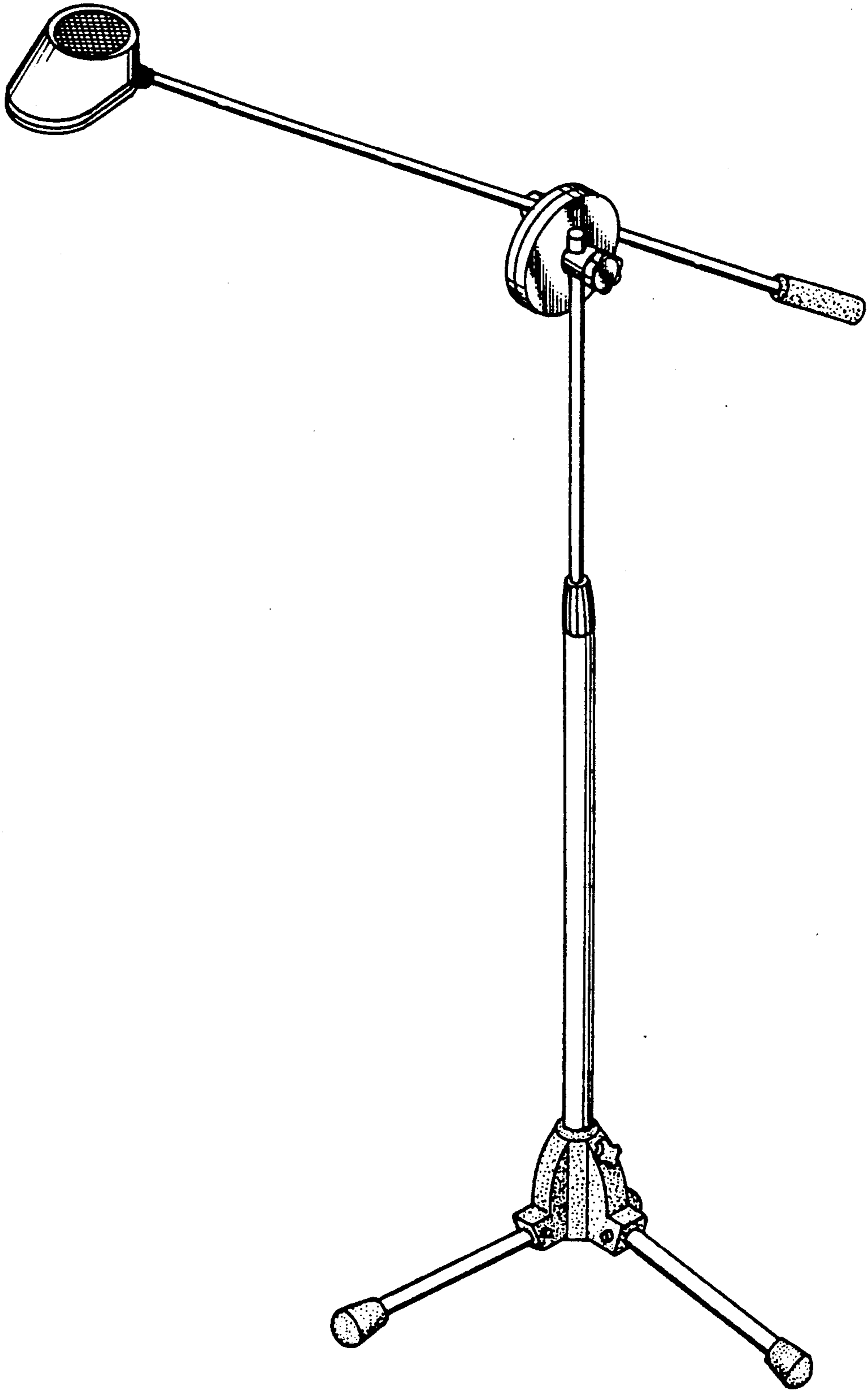

Fig. 1

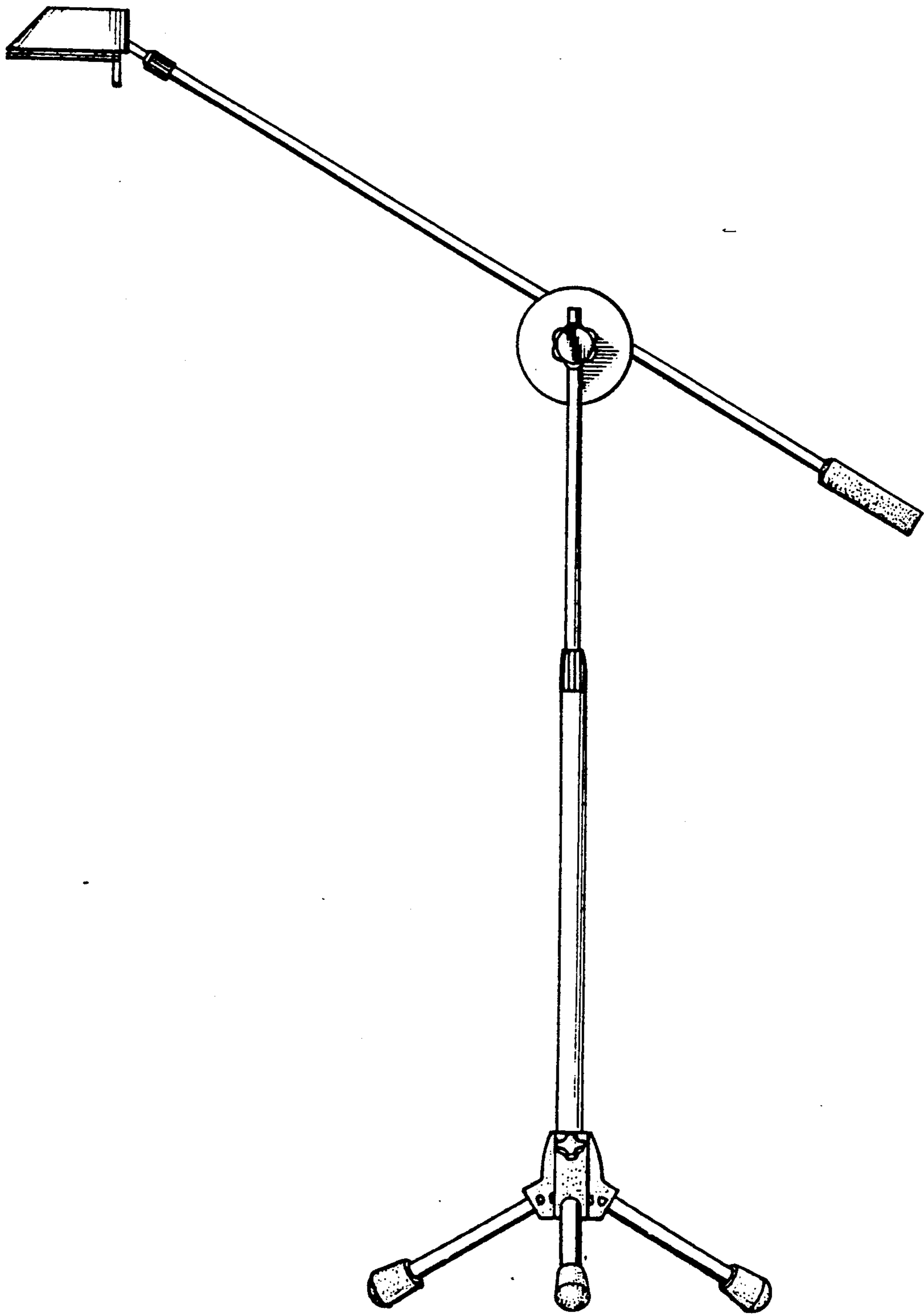

Fig. 2

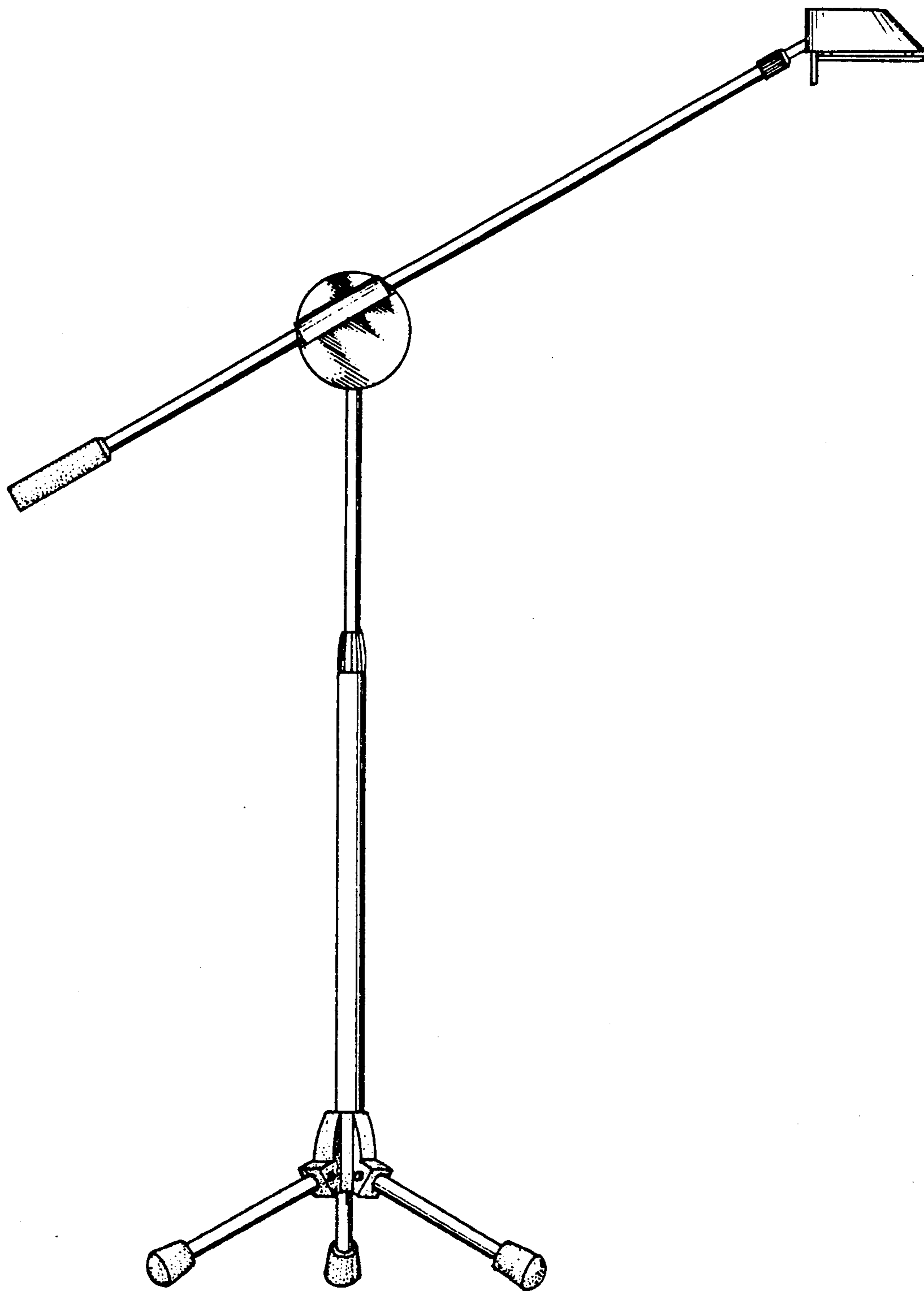

Fig. 3

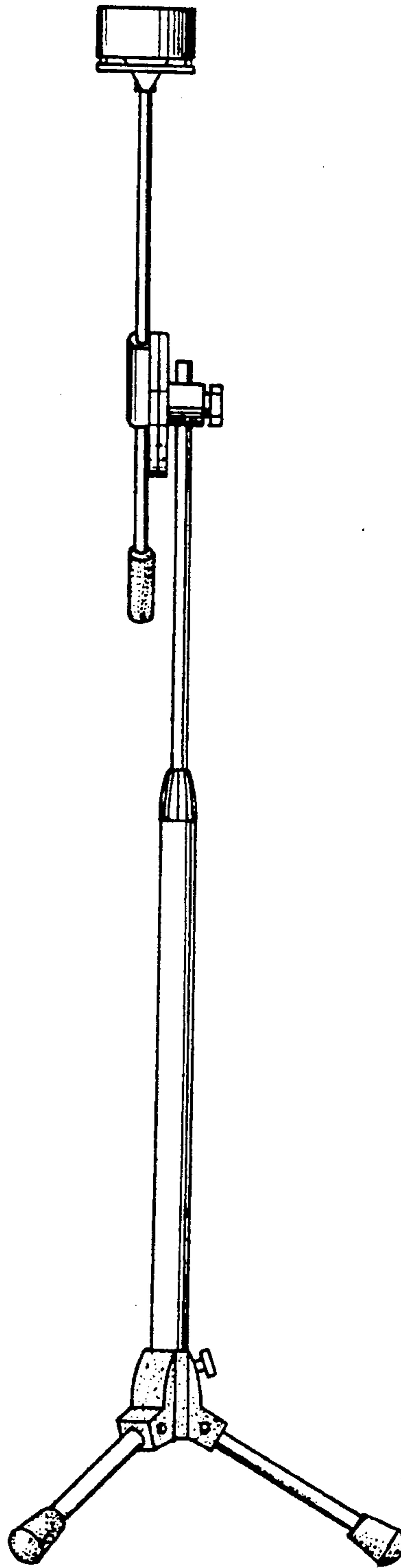

Fig. 4

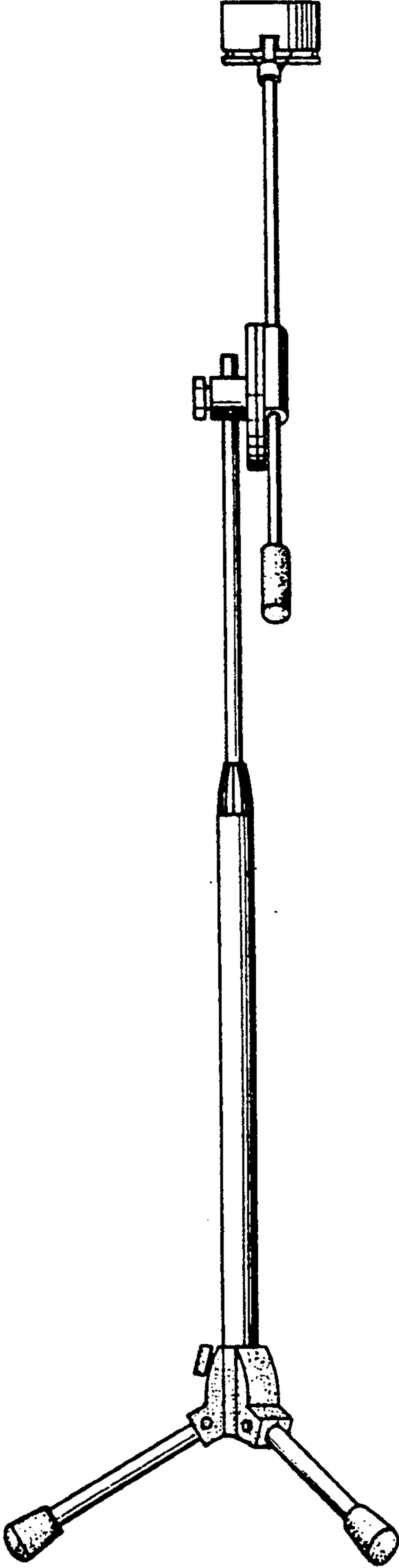

Fig. 5

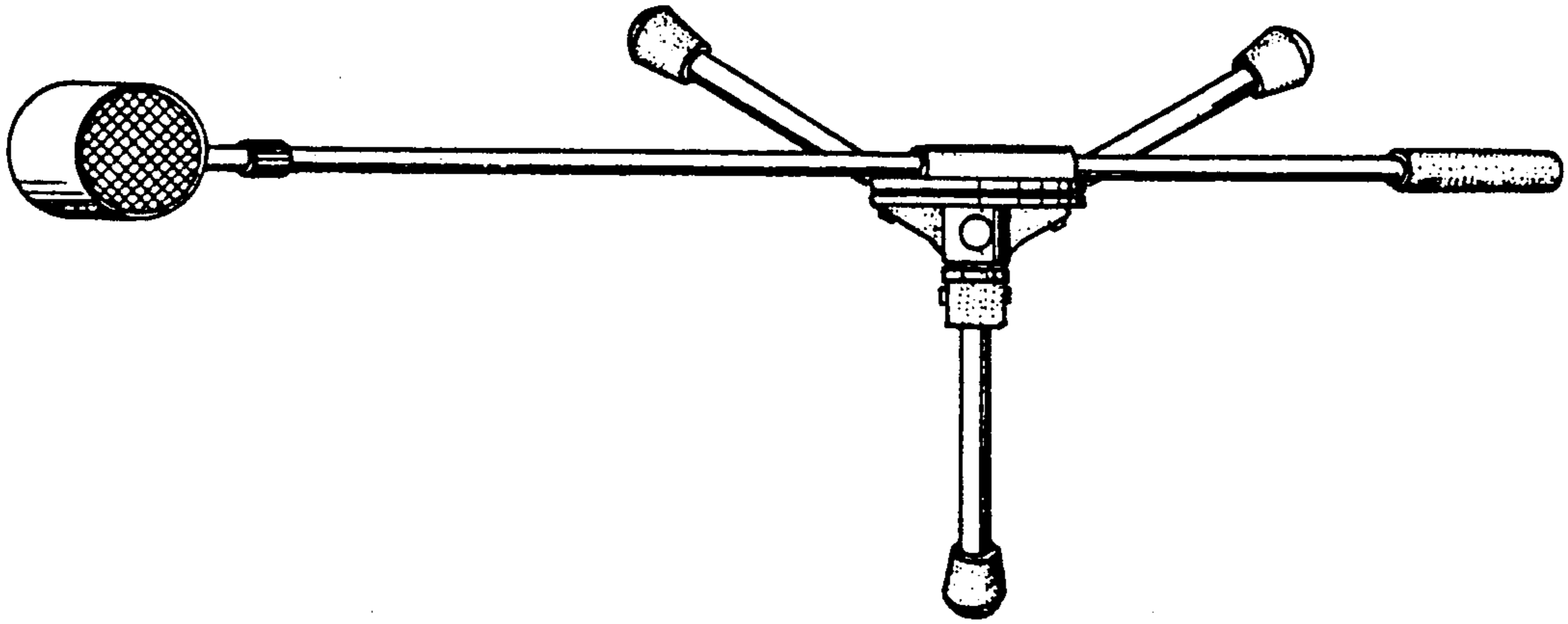

Fig. 6

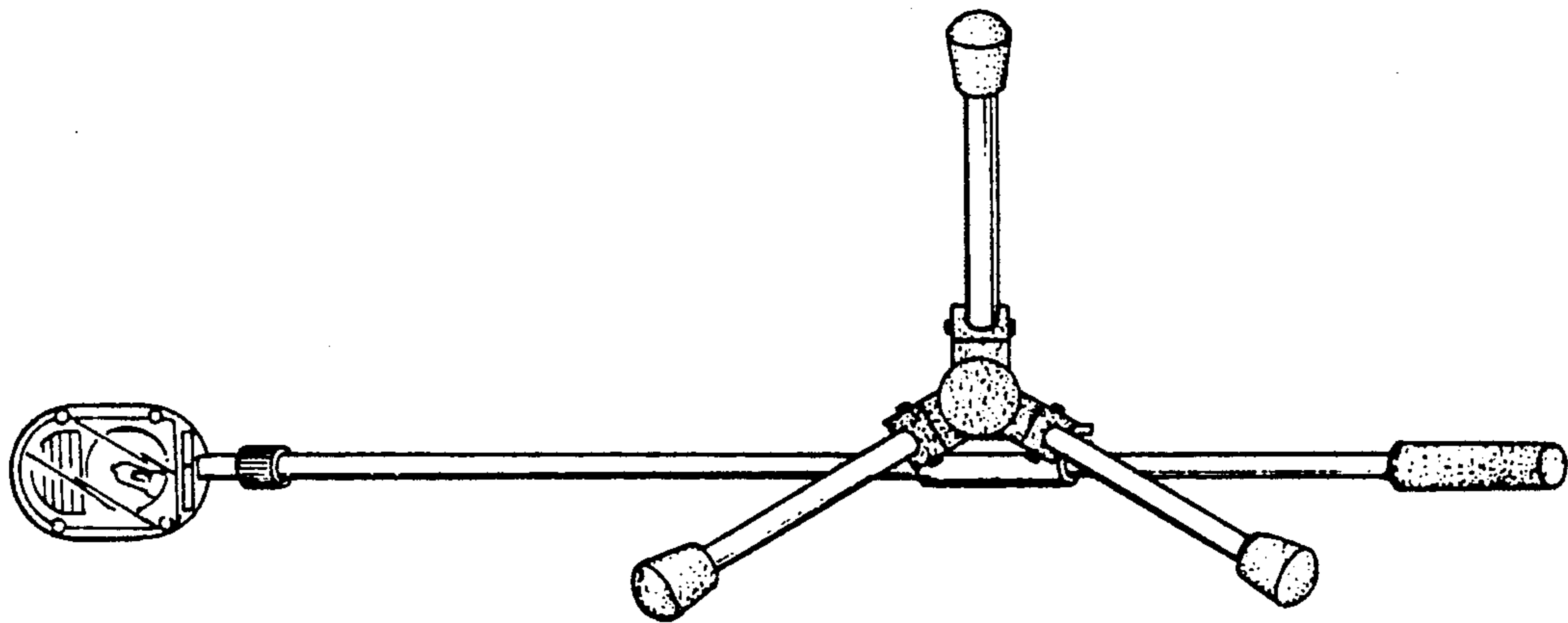

Fig. 7