



US00D330478S

# United States Patent [19]

[11] Patent Number: **Des. 330,478**

**Wogoman et al.**

[45] Date of Patent: **\*\* Oct. 27, 1992**

[54] SEAT

[75] Inventors: **Steven S. Wogoman, Elkhart, Ind.;**  
**Robert G. Martinez, Akron, Ohio**

[73] Assignee: **Harter Corporation, Sturgis, Mich.**

[\*\*] Term: **14 Years**

[21] Appl. No.: **364,184**

[22] Filed: **Jun. 9, 1989**

[52] U.S. Cl. .... **D6/500**

[58] Field of Search ..... **D6/491, 500-503,**  
**D6/509-511, 364-366, 379, 380; 297/418**

[56] **References Cited**

**U.S. PATENT DOCUMENTS**

D. 274,675	7/1984	Diffrient	.....	D6/366
D. 277,143	1/1985	Helmholdt	.....	D6/366
D. 279,332	6/1985	Diffrient	.....	D6/364 X
D. 292,655	11/1987	Hendrick	.....	D6/366
D. 309,385	7/1990	Buhk	.....	D6/501 X

**OTHER PUBLICATIONS**

*Interiors*, Feb. 1984, p. 26, Anthropom Chair center of page.

*Primary Examiner*—Nelson C. Holtje  
*Assistant Examiner*—Janice E. Seeger  
*Attorney, Agent, or Firm*—Renner, Kenner, Greive,  
Bobak, Taylor & Weber

[57] **CLAIM**

The ornamental design for a seat, as shown and described.

**DESCRIPTION**

FIG. 1 is a perspective view of a seat, showing our new design, the broken lines are for illustrative purposes only and form no part of the claimed design;  
FIG. 2 is a left side elevational view, the right side being a mirror image thereof;  
FIG. 3 is a top perspective view;  
FIG. 4 is a front perspective view;  
FIG. 5 is a rear perspective view;  
FIG. 6 is a bottom plan view;  
FIG. 7 is a left side elevational view of an alternate embodiment of our new design, the right side being a mirror image thereof;  
FIG. 8 is a front perspective view of the alternate embodiment; and,  
FIG. 9 is a top perspective view of the alternate embodiment.

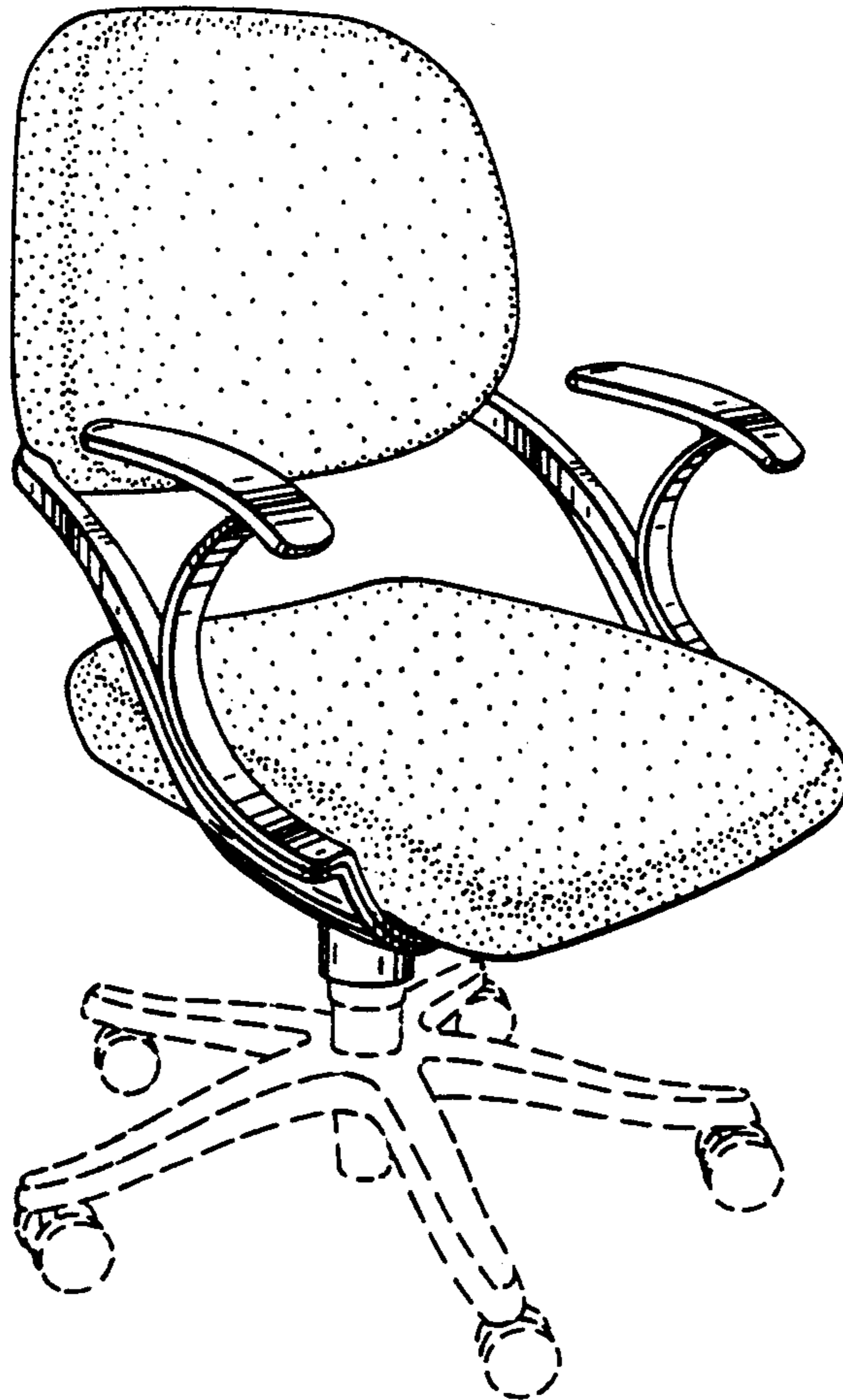

FIG. 1

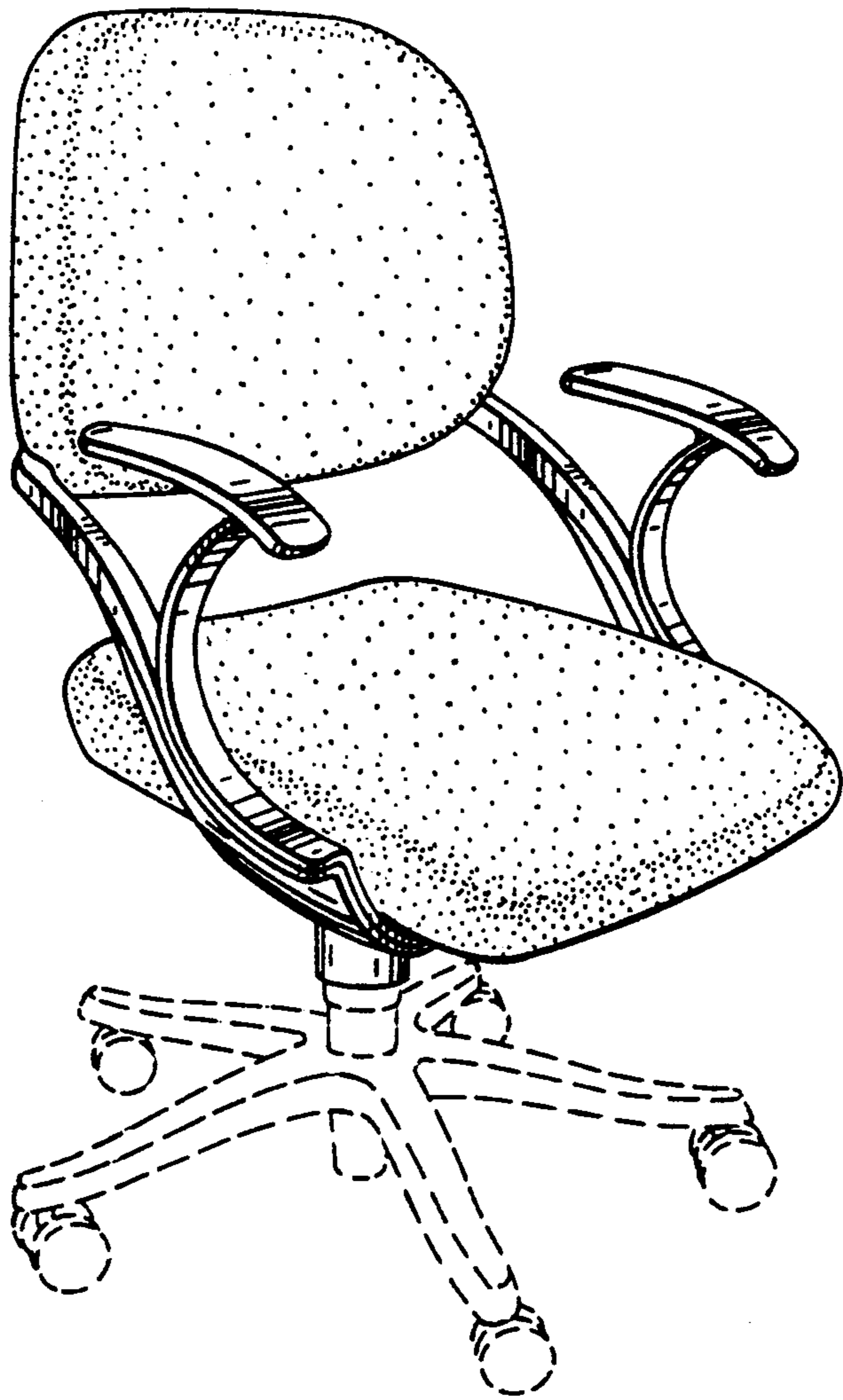
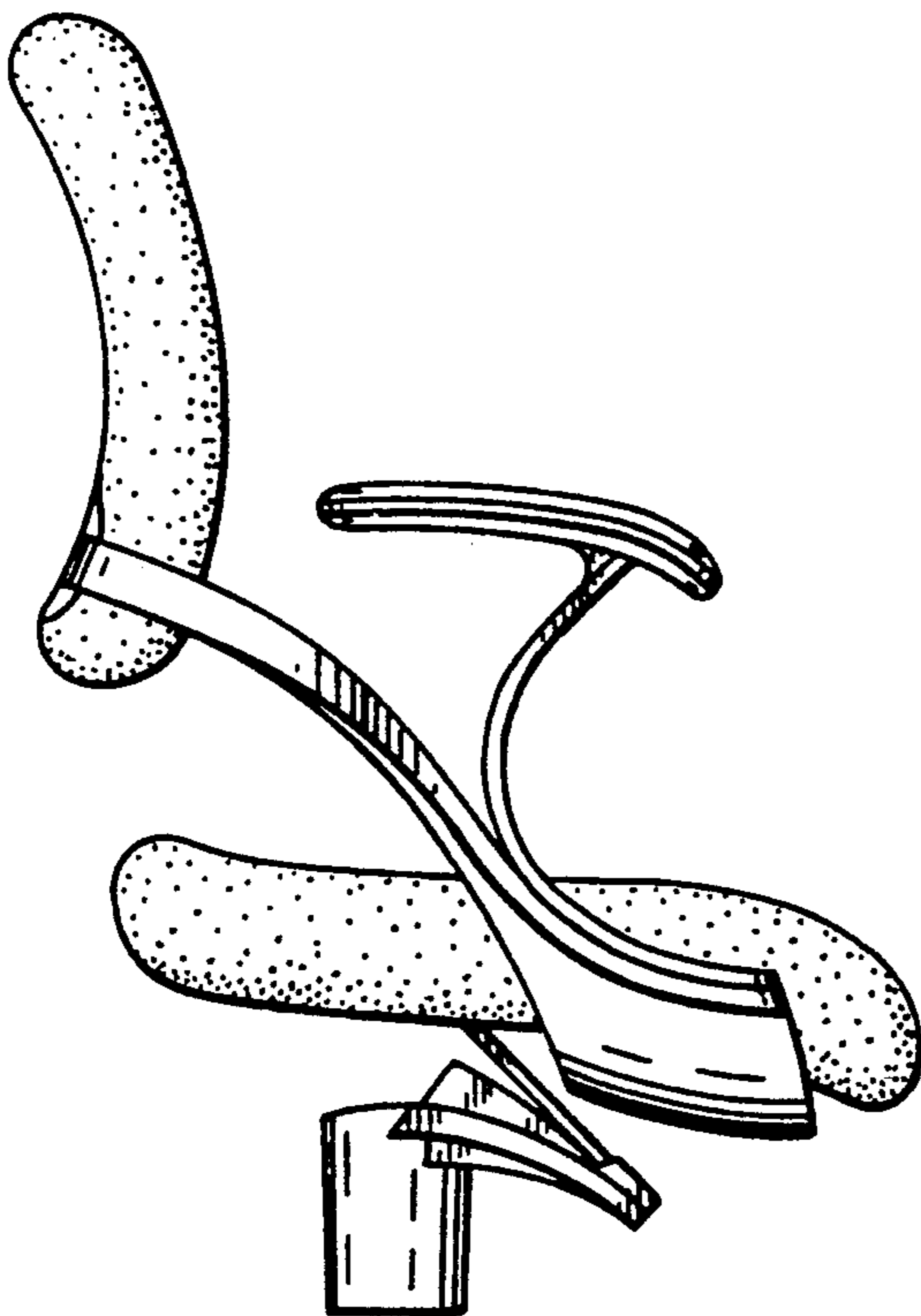

FIG. 2



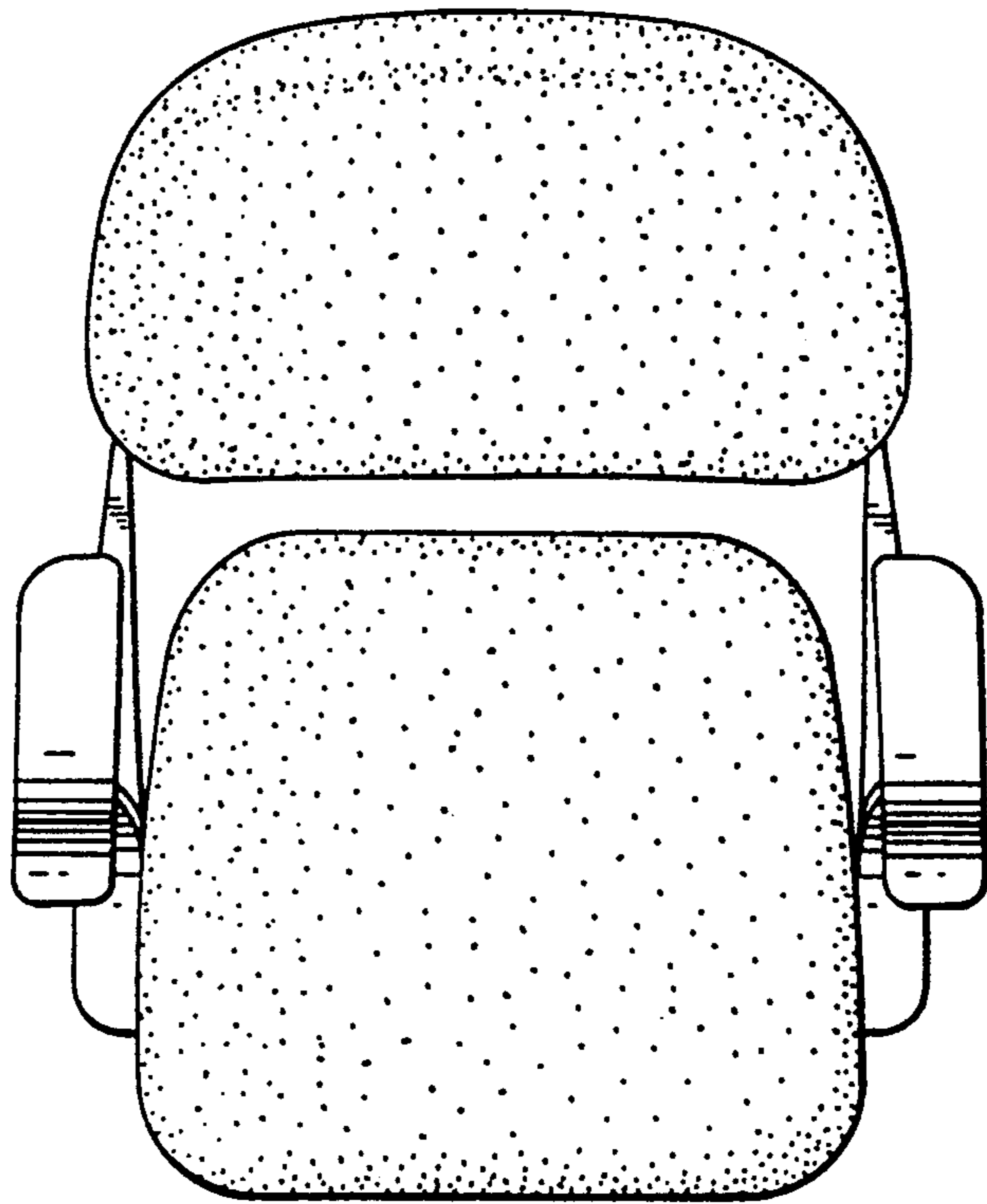

FIG. 3

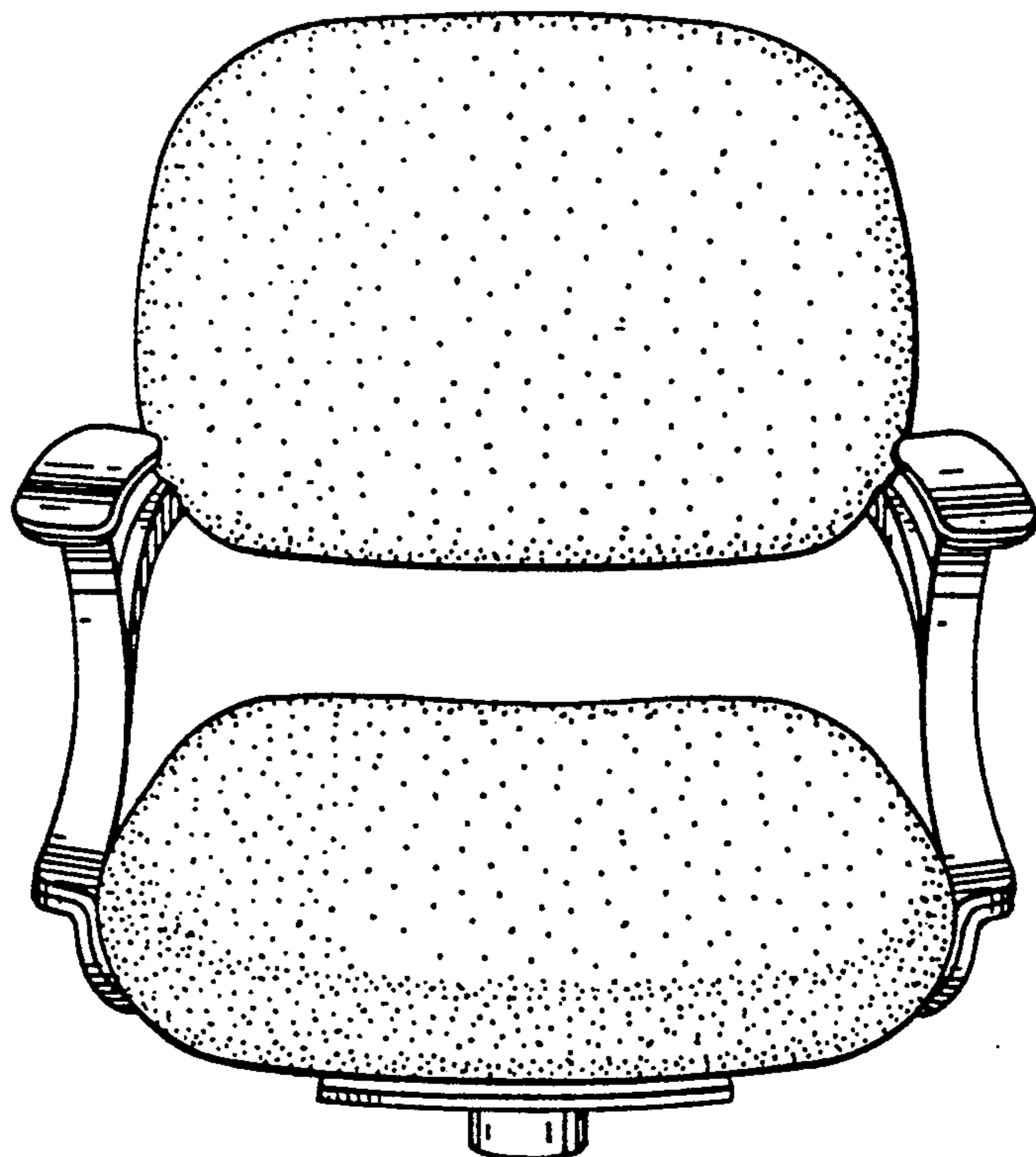

FIG. 4

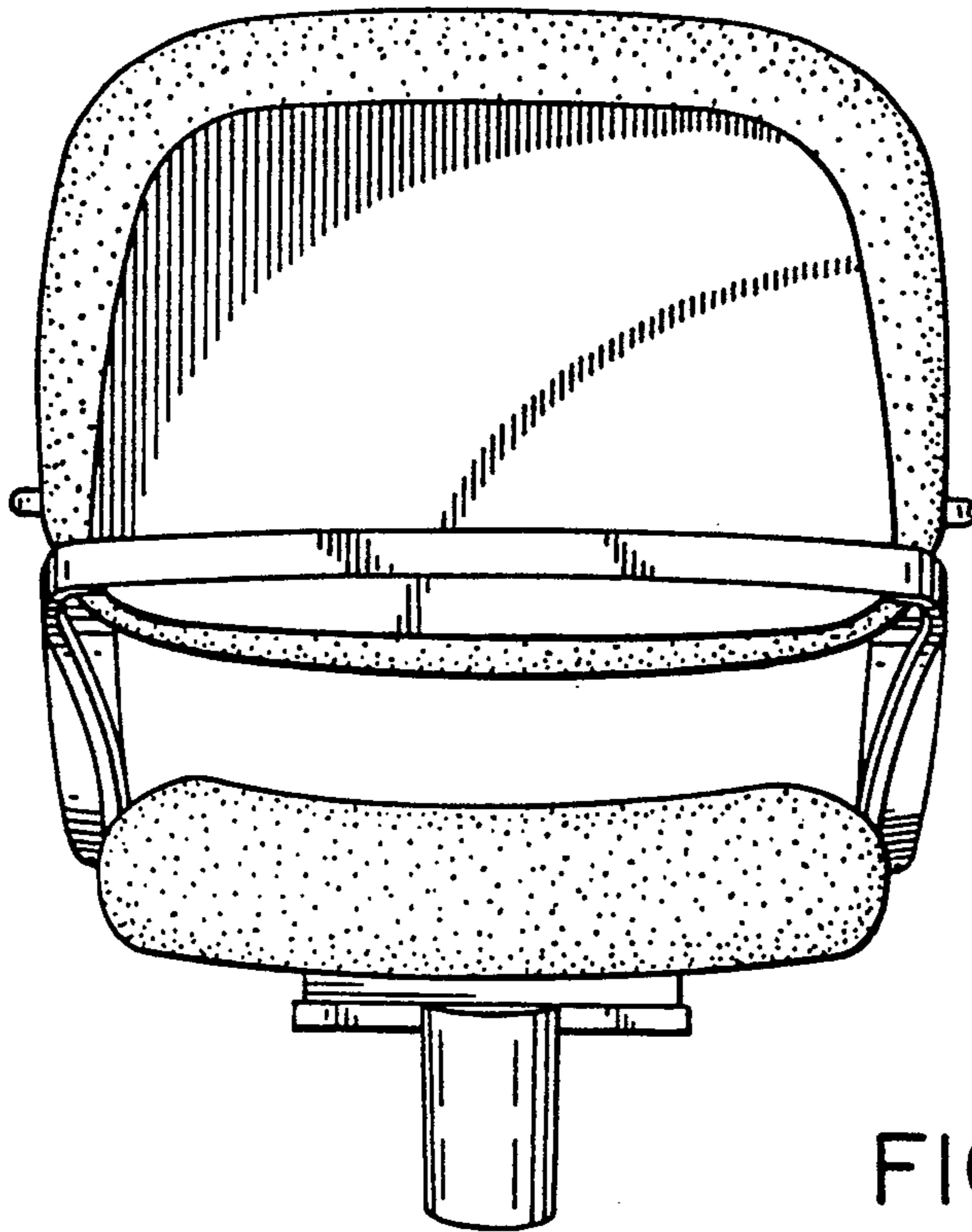

FIG. 5

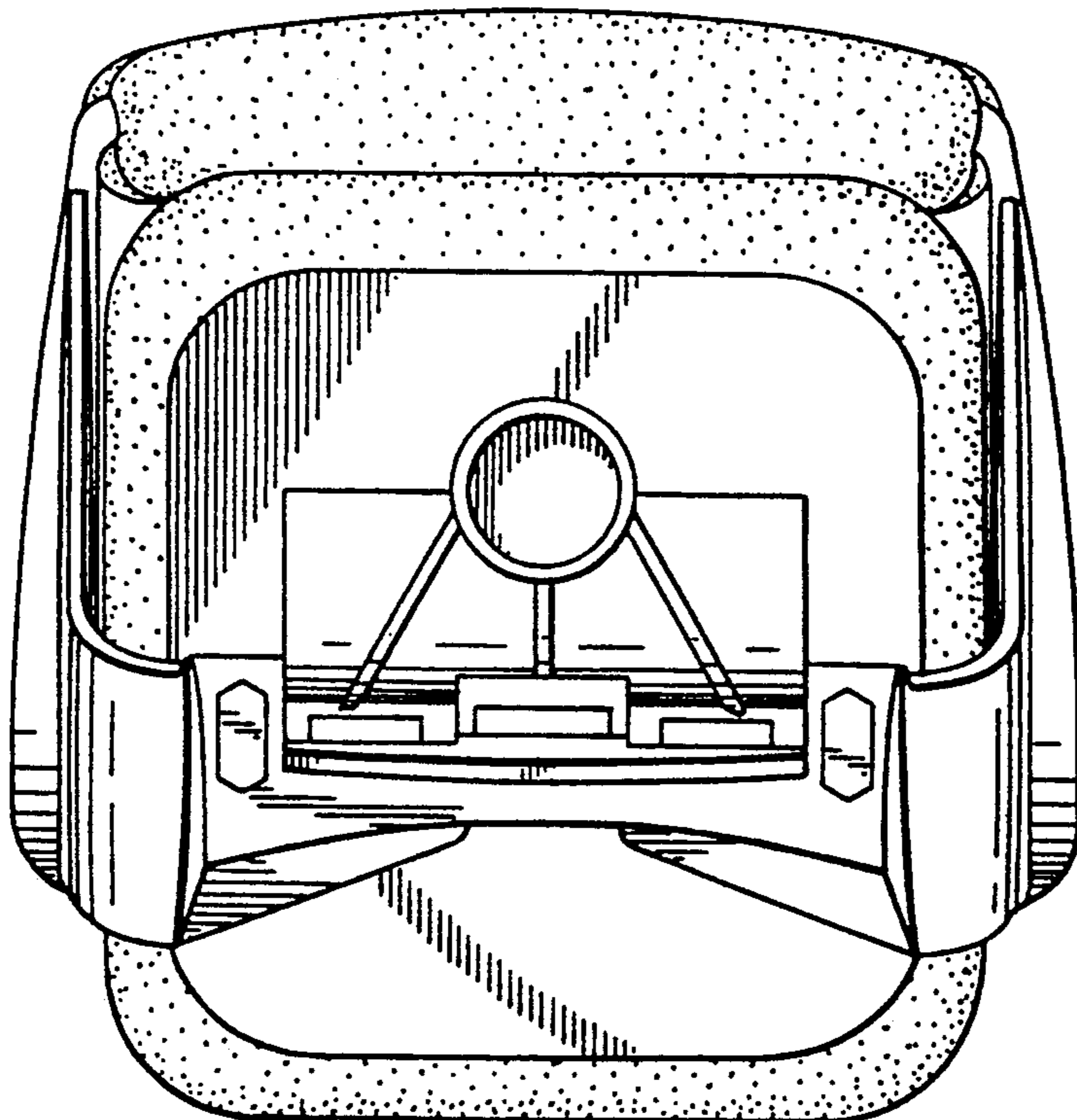

FIG. 6

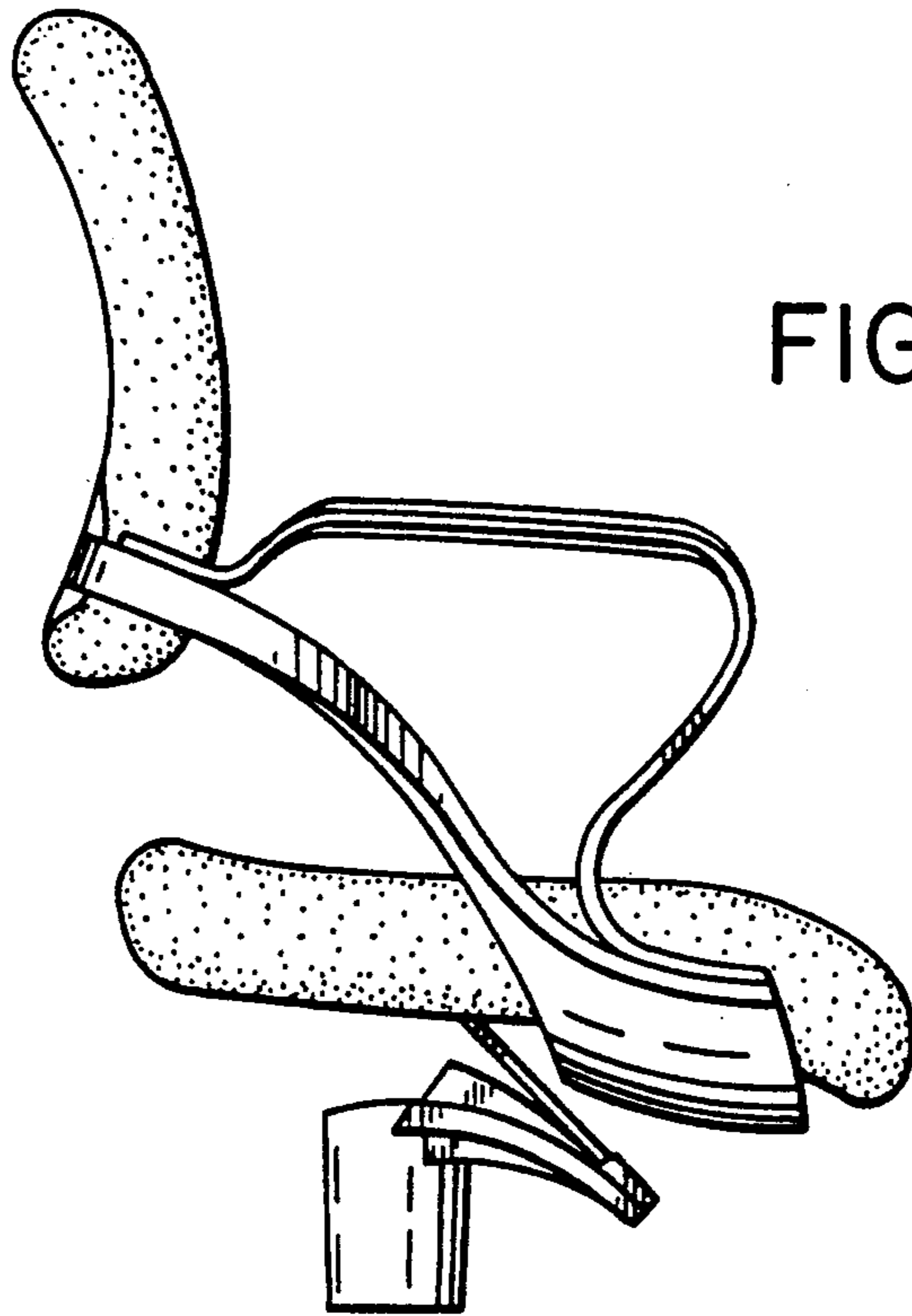

FIG. 7

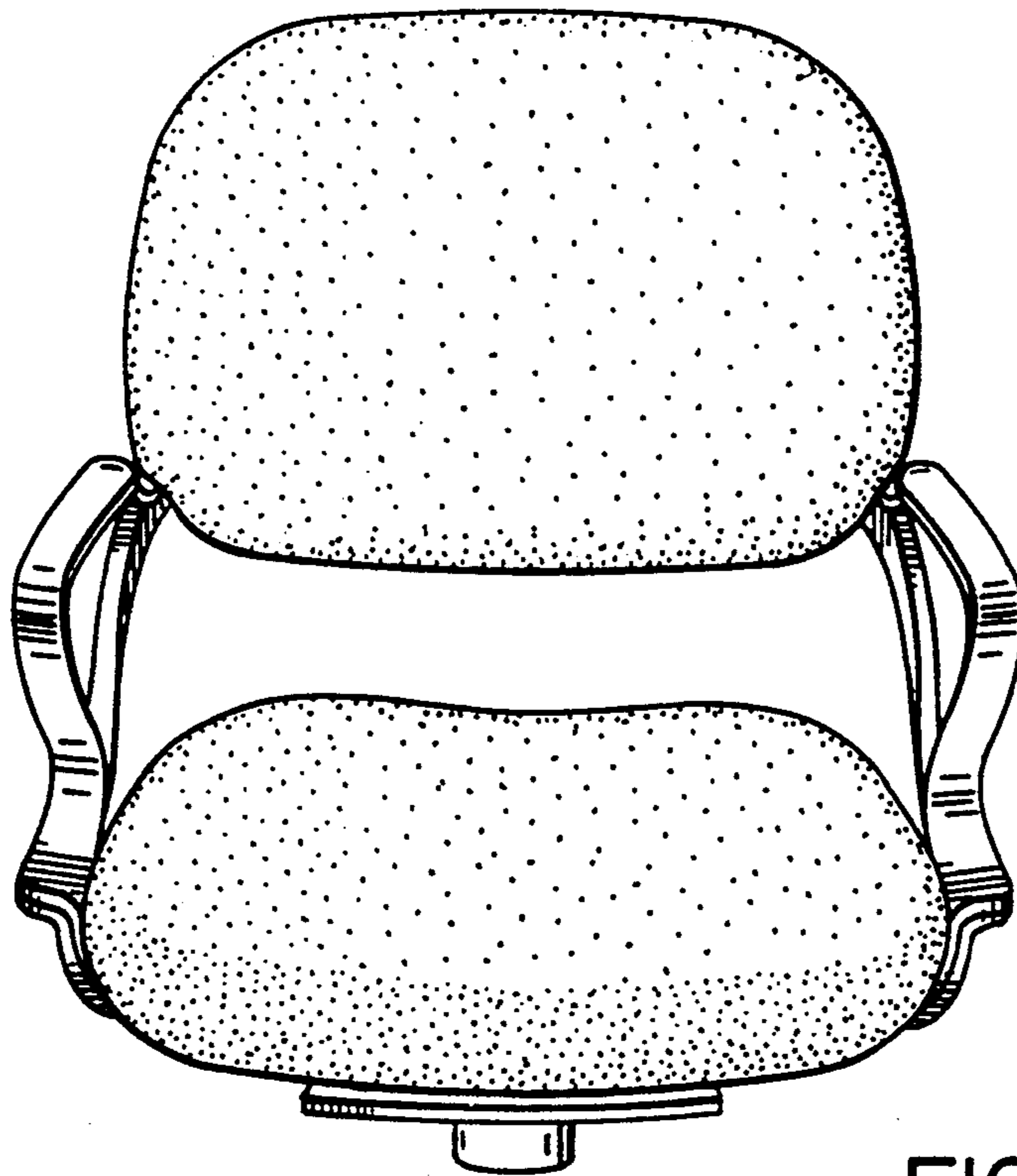

FIG. 8

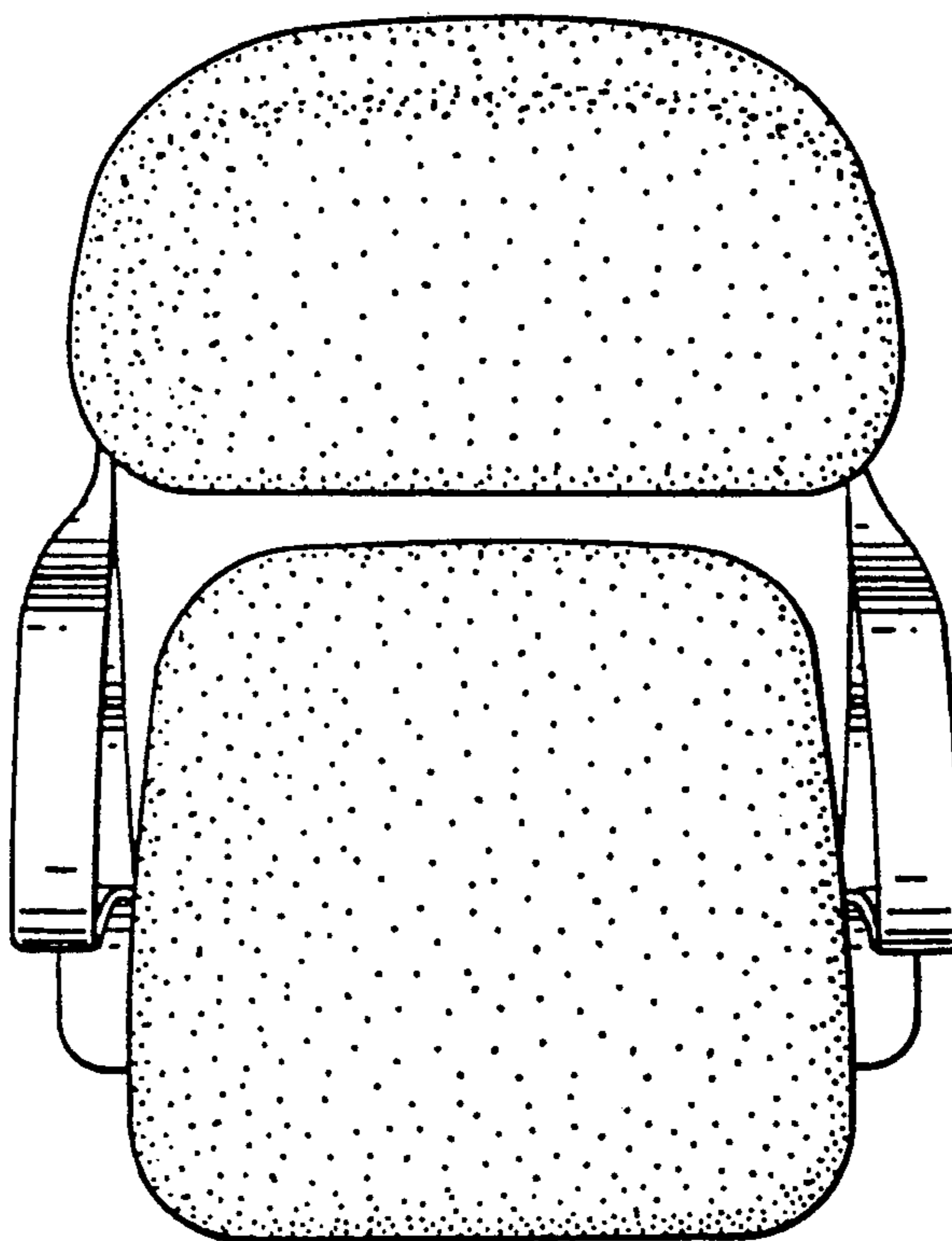

FIG. 9