



US00D330441S

**United States Patent** [19]  
**Cury**

[11] **Patent Number: Des. 330,441**

[45] **Date of Patent: \*\* Oct. 20, 1992**

[54] **CIGARETTE LIGHTER**

[76] **Inventor: Brian L. Cury, 87 Maple St., Teaneck, N.J. 07666**

[\*\*] **Term: 14 Years**

[21] **Appl. No.: 741,832**

[22] **Filed: Aug. 7, 1991**

[52] **U.S. Cl. .... D27/157; D27/154**

[58] **Field of Search .... D27/141-160, D27/139-140; D28/88-90; 431/124-141**

[56] **References Cited**

**U.S. PATENT DOCUMENTS**

- D. 180,040 4/1957 Slater ..... D28/90
- D. 305,268 12/1989 Cheng ..... D28/88
- D. 306,775 3/1990 Ichikawa ..... D27/154 X

**FOREIGN PATENT DOCUMENTS**

781354 11/1989 Japan .

**OTHER PUBLICATIONS**

Benjamin Allen Catalog, 1956, p. 90-R, lighter, item A at left of page.

The Gift & Art Buyer, Aug. 1948, p. 212, lighter, located on bottom left hand side.

*Primary Examiner*—Wallace R. Burke

*Assistant Examiner*—H. Baynham

*Attorney, Agent, or Firm*—Fitzpatrick, Cella, Harper & Scinto

[57] **CLAIM**

The ornamental design for a cigarette lighter, as shown and described.

**DESCRIPTION**

FIG. 1 is a front elevational view of a cigarette lighter showing my new design;

FIG. 2 is a right side elevational view thereof;

FIG. 3 is a left side elevational view thereof;

FIG. 4 is a top plan view thereof;

FIG. 5 is a bottom plan view thereof;

FIG. 6 is a front elevational view thereof with the lid in an opened position;

FIG. 7 is a right side elevational view thereof;

FIG. 8 is a top plan view thereof; and,

FIG. 9 is a perspective view thereof.

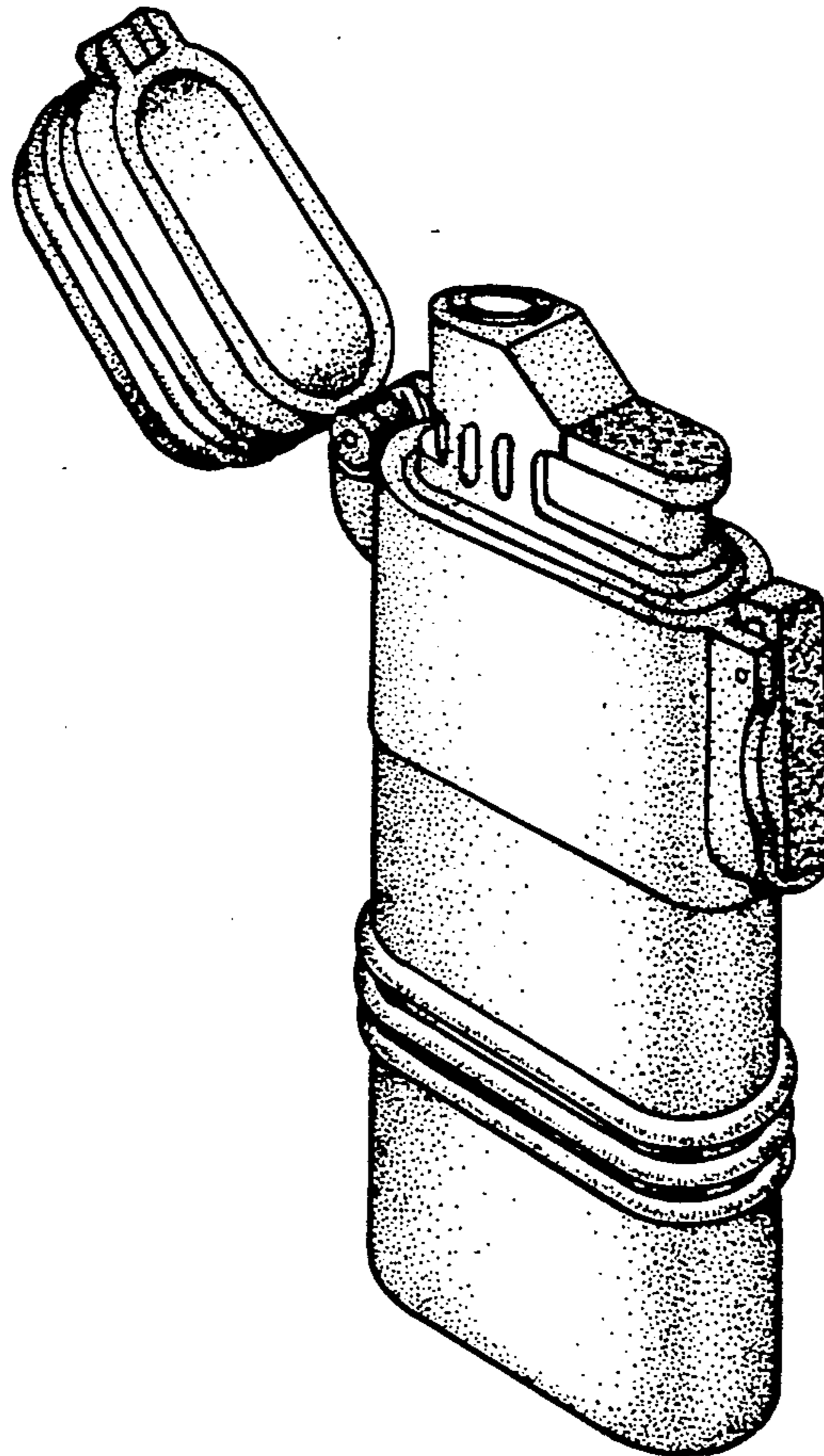

Fig. 1.

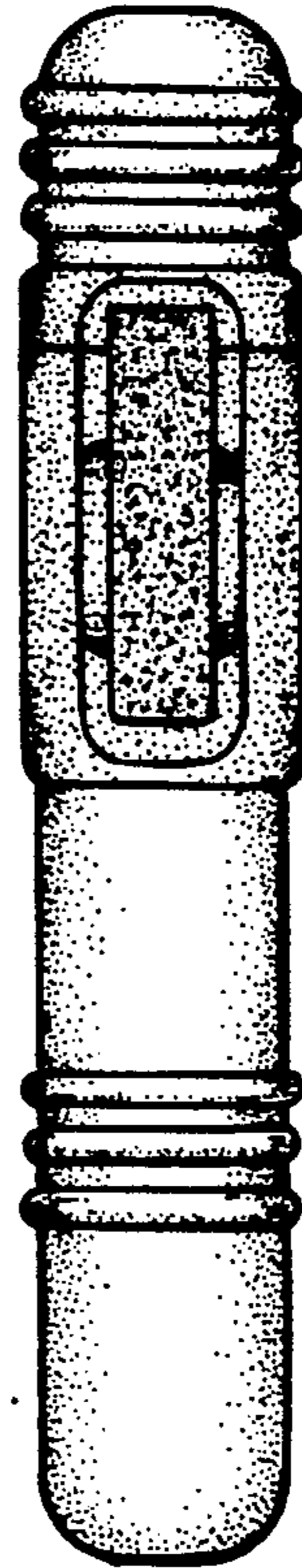
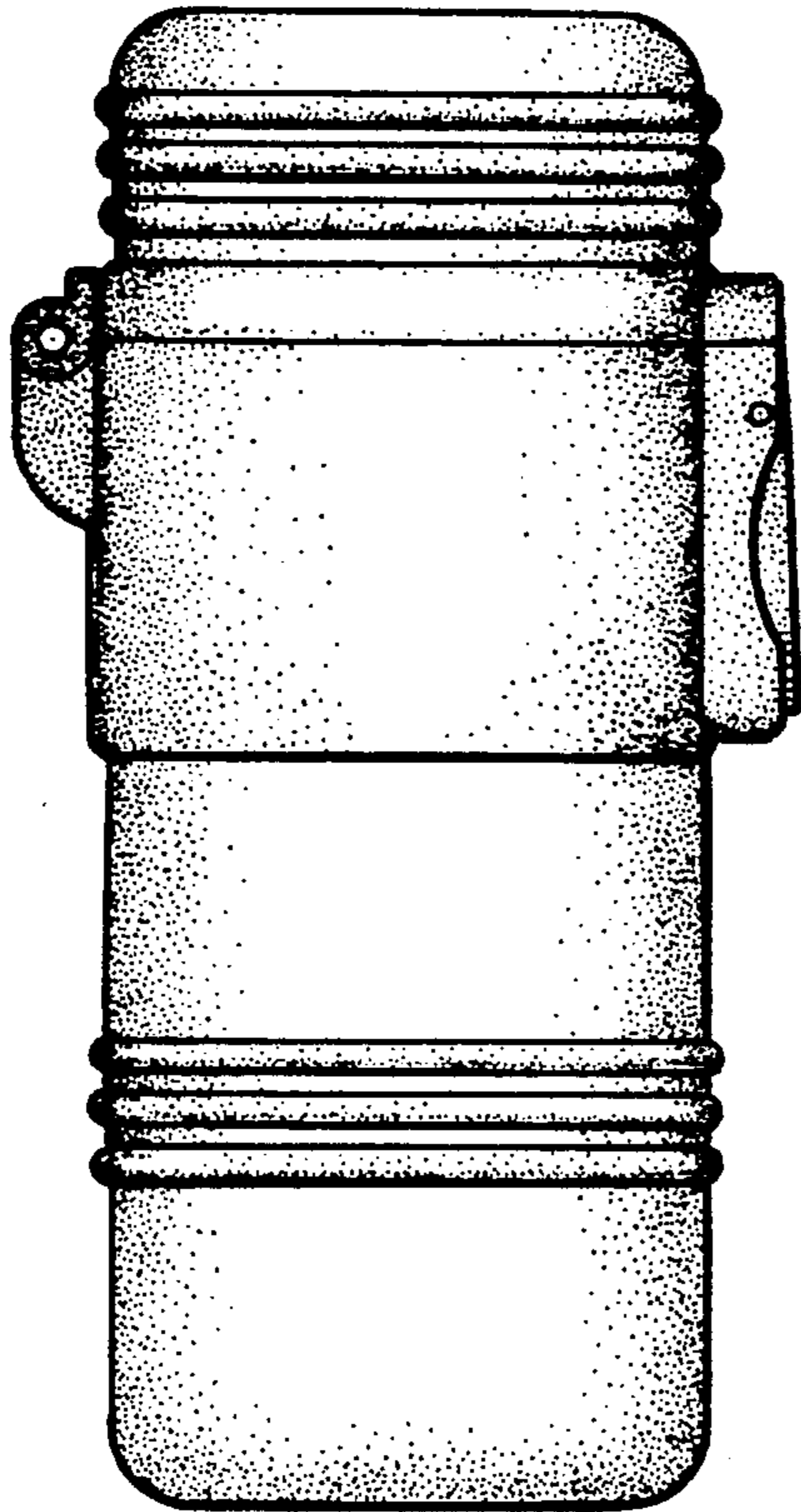

Fig. 2

Fig. 3.

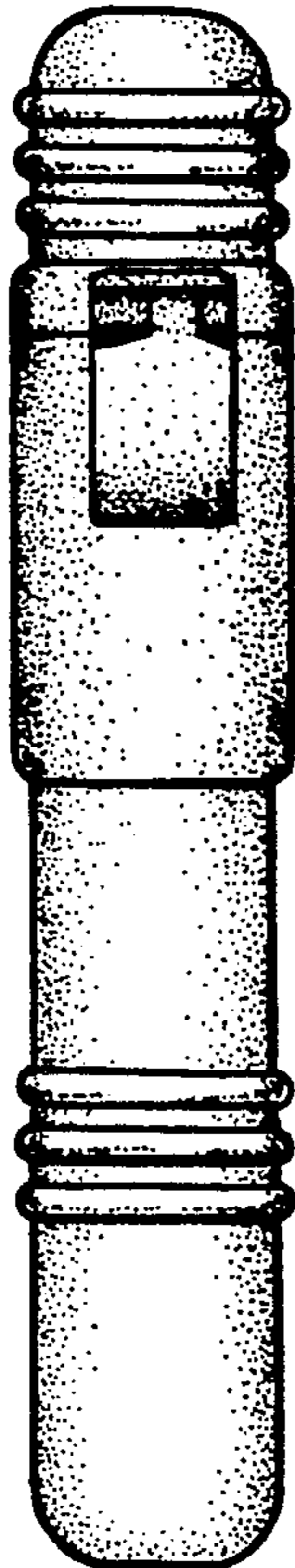

Fig. 4.

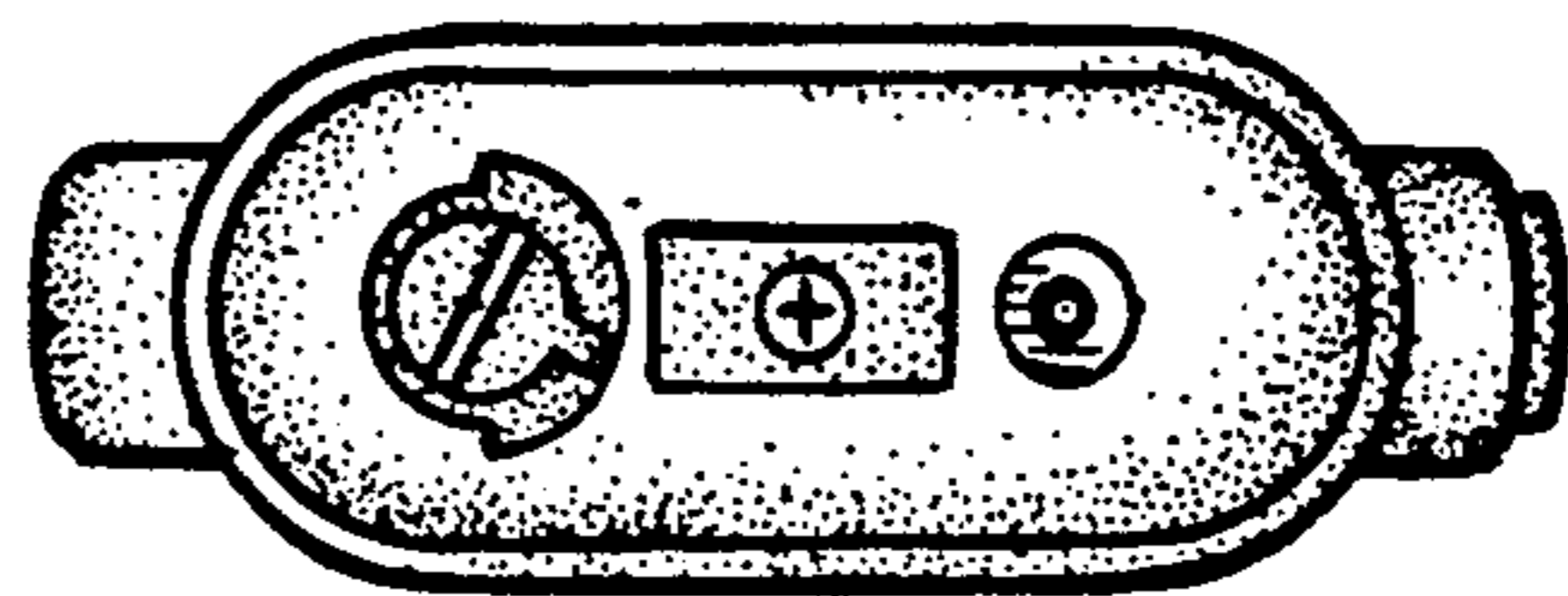

Fig. 5.

Fig. 6.

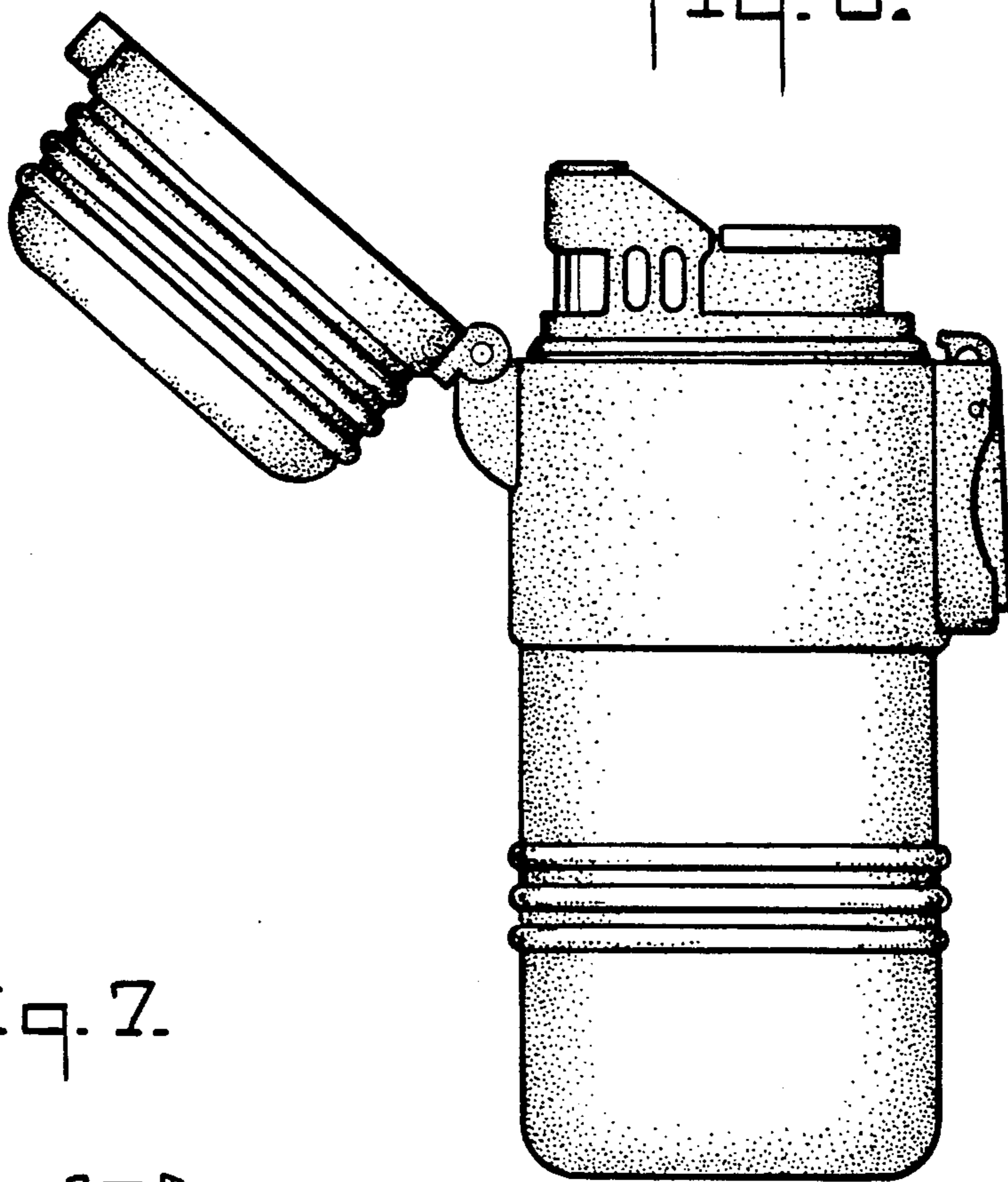

Fig. 7.

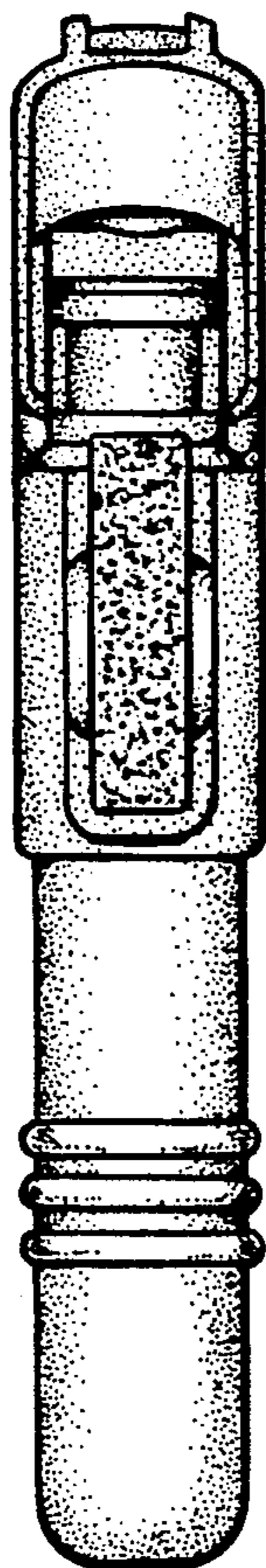
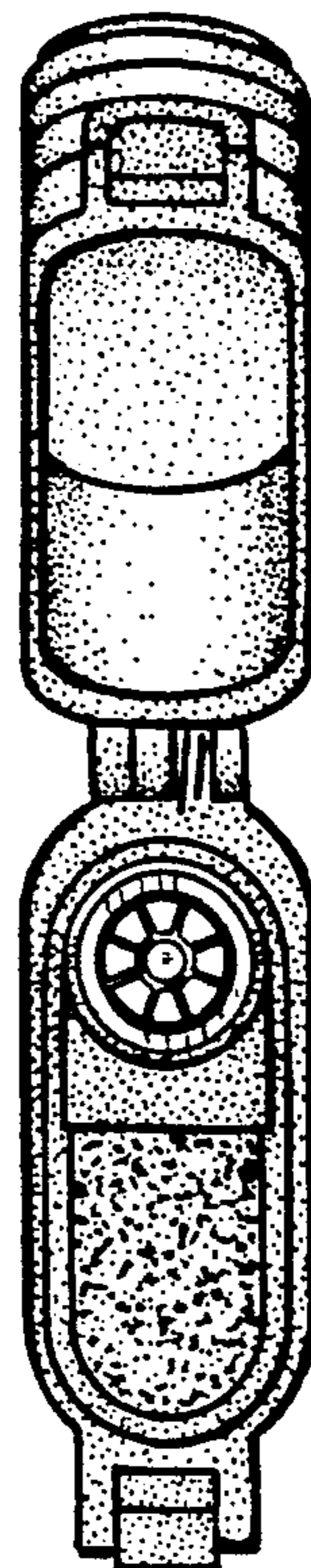

Fig. 8.



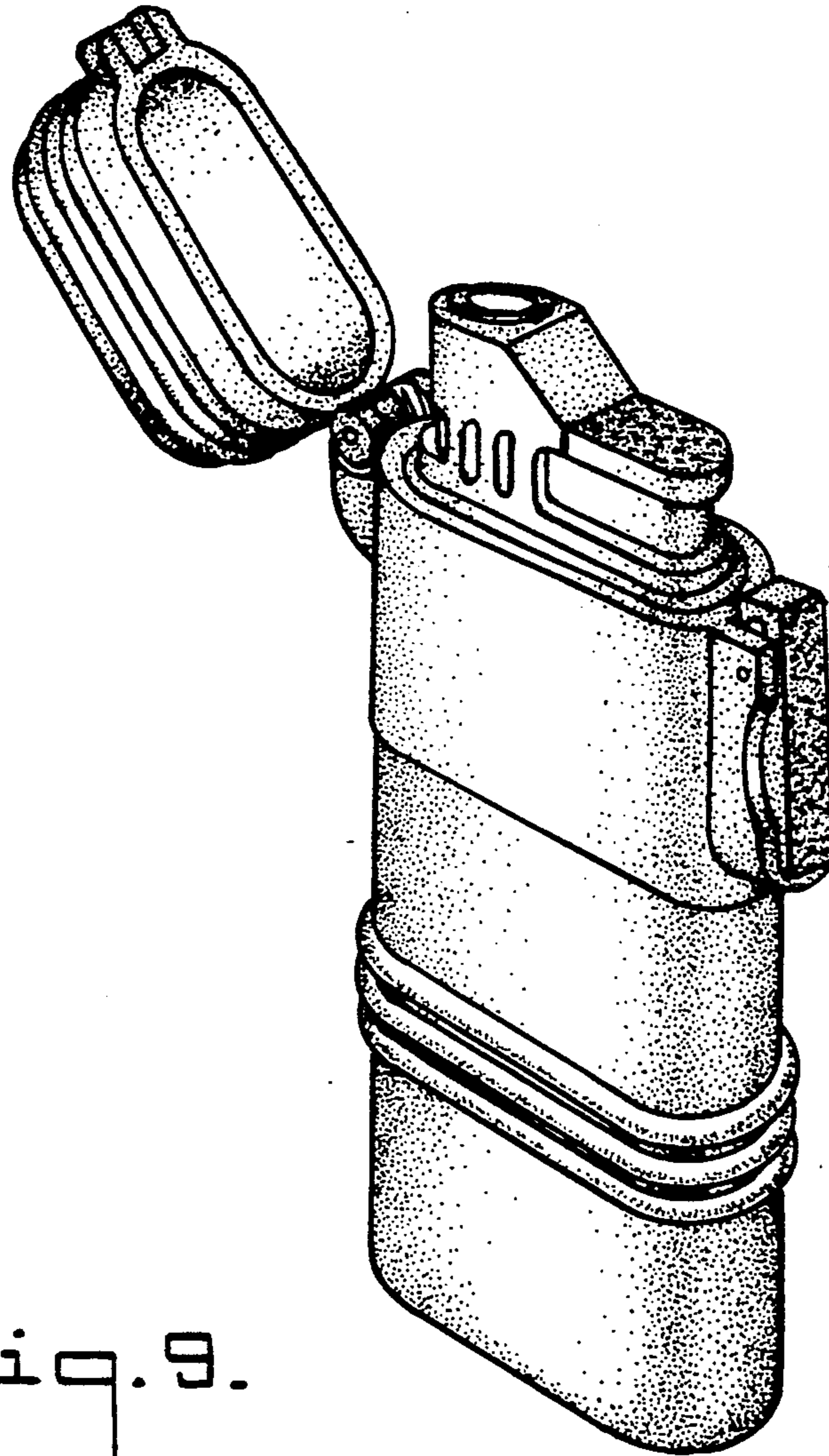

Fig. 9.

UNITED STATES PATENT AND TRADEMARK OFFICE  
CERTIFICATE OF CORRECTION

PATENT NO. : Des. 330,441  
DATED : October 20, 1992  
INVENTOR(S) : BRIAN L. CURY

It is certified that error appears in the above-identified patent and that said Letters Patent is hereby corrected as shown below: Title page:

AT [56] REFERENCES CITED

U.S. Patent Documents, insert		
-- 2,461,890	2/1949	Fox..... 67
2,692,490	10/1954	Florman..... 67
D. 152,642	2/1949	Nathan et al.....D48
D. 226,581	3/1973	Goto.....D27
D. 243,863	3/1977	Lowenthal.....D27
D. 246,997	1/1978	Nitta.....D27
D. 248,409	7/1978	Spreter.....D27
D. 251,072	2/1979	Steutzer.....D27
D. 260,942	9/1981	Steutzer.....D27
D. 261,814	11/1981	Spreter.....D27
D. 269,211	5/1983	Steutzer et al.....D27--.

Foreign Patent Documents, insert  
--781353 11/1989 Japan--.

Signed and Sealed this  
Ninth Day of November, 1993



BRUCE LEHMAN

Commissioner of Patents and Trademarks

Attest:

Attesting Officer