



US00D330414S

United States Patent [19]

[11] Patent Number: **Des. 330,414**

Creswell

[45] Date of Patent: **** Oct. 20, 1992**

[54] **ROOM AIR FRESHENER**

[76] Inventor: **Joe P. Creswell, Rte. 6 Box 431, Lebanon, Tenn. 37087**

[**] Term: **14 Years**

[21] Appl. No.: **497,150**

[22] Filed: **Mar. 22, 1990**

[52] U.S. Cl. **D23/368**

[58] Field of Search D23/200, 207-208, D23/213, 366-369; 4/223-224, 227-228, 231; 422/5, 123, 174, 305; 261/DIG. 65; 239/55, 57, 59

4,261,957 4/1981 Schimanski 4/228 X
4,280,649 7/1981 Montealegre 239/57 X
4,777,670 10/1988 Klinkhammer et al. 4/223 X
4,950,457 8/1990 Weick 239/59 X

Primary Examiner—Susan J. Lucas
Assistant Examiner—M. H. Tung
Attorney, Agent, or Firm—Leon Gilden

[57] **CLAIM**

The ornamental design for a room air freshener, as shown and described.

DESCRIPTION

FIG. 1 is a front elevational view of the room air freshener showing my new design;
FIG. 2 is a rear elevational view thereof;
FIG. 3 is a left side elevational view thereof;
FIG. 4 is a right side elevational view thereof;
FIG. 5 is a top plan view thereof;
FIG. 6 is a bottom plan view thereof; and,
FIG. 7 is a top perspective view thereof.

[56] **References Cited**

U.S. PATENT DOCUMENTS

D. 242.621 12/1976 Curran D23/366
D. 246.319 11/1977 Rabussier et al. D23/369
D. 304.758 11/1989 Glucksman et al. D23/366
2,579,045 12/1951 Levit D23/368 X
3,694,354 9/1972 Nolte, Jr. D23/208 X

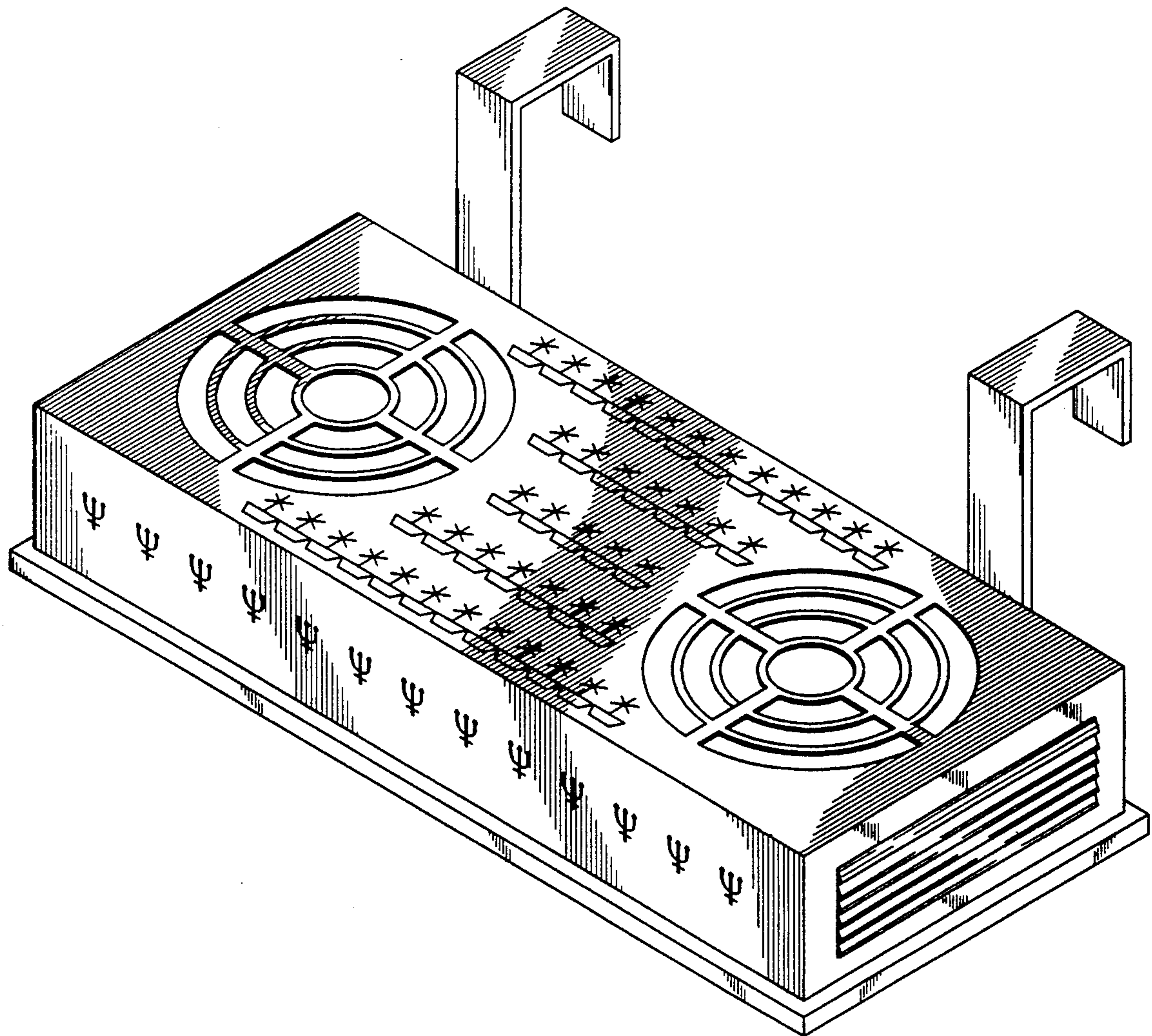

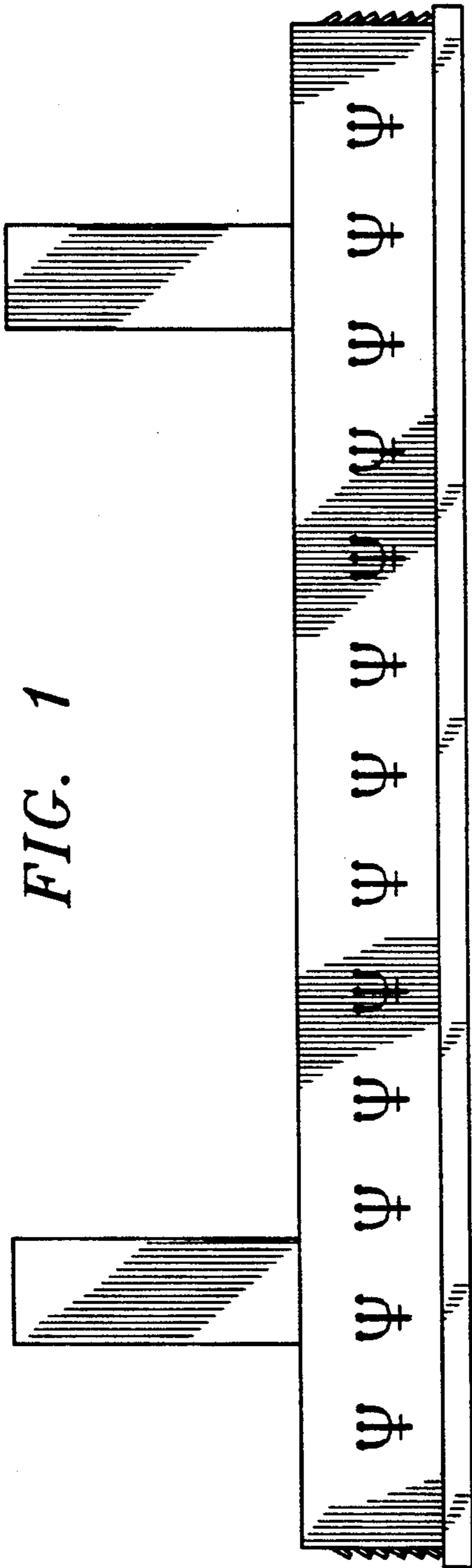

FIG. 1

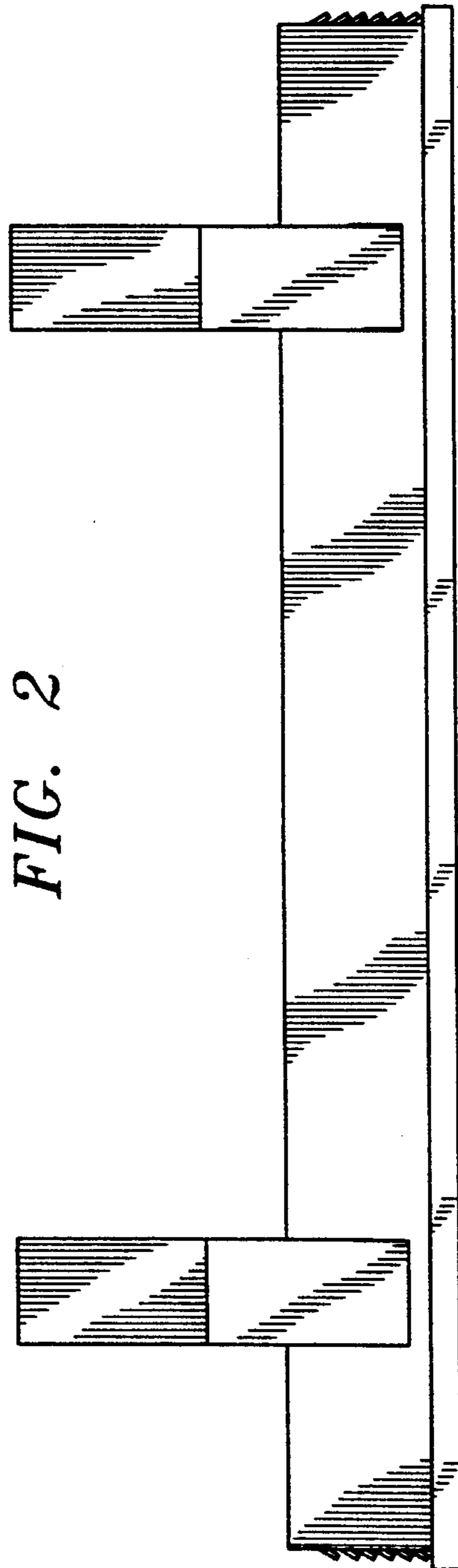

FIG. 2

FIG. 3

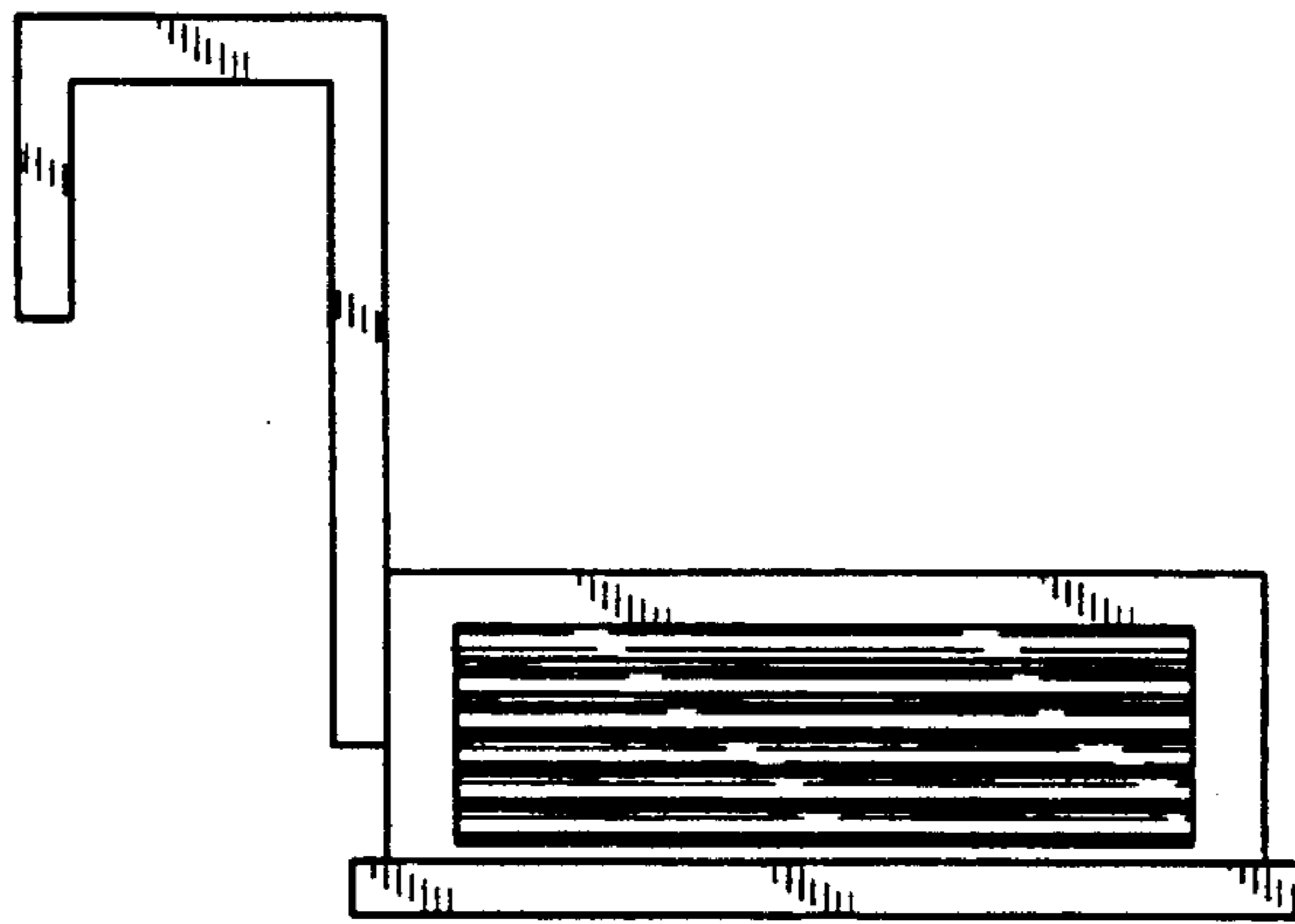

FIG. 4

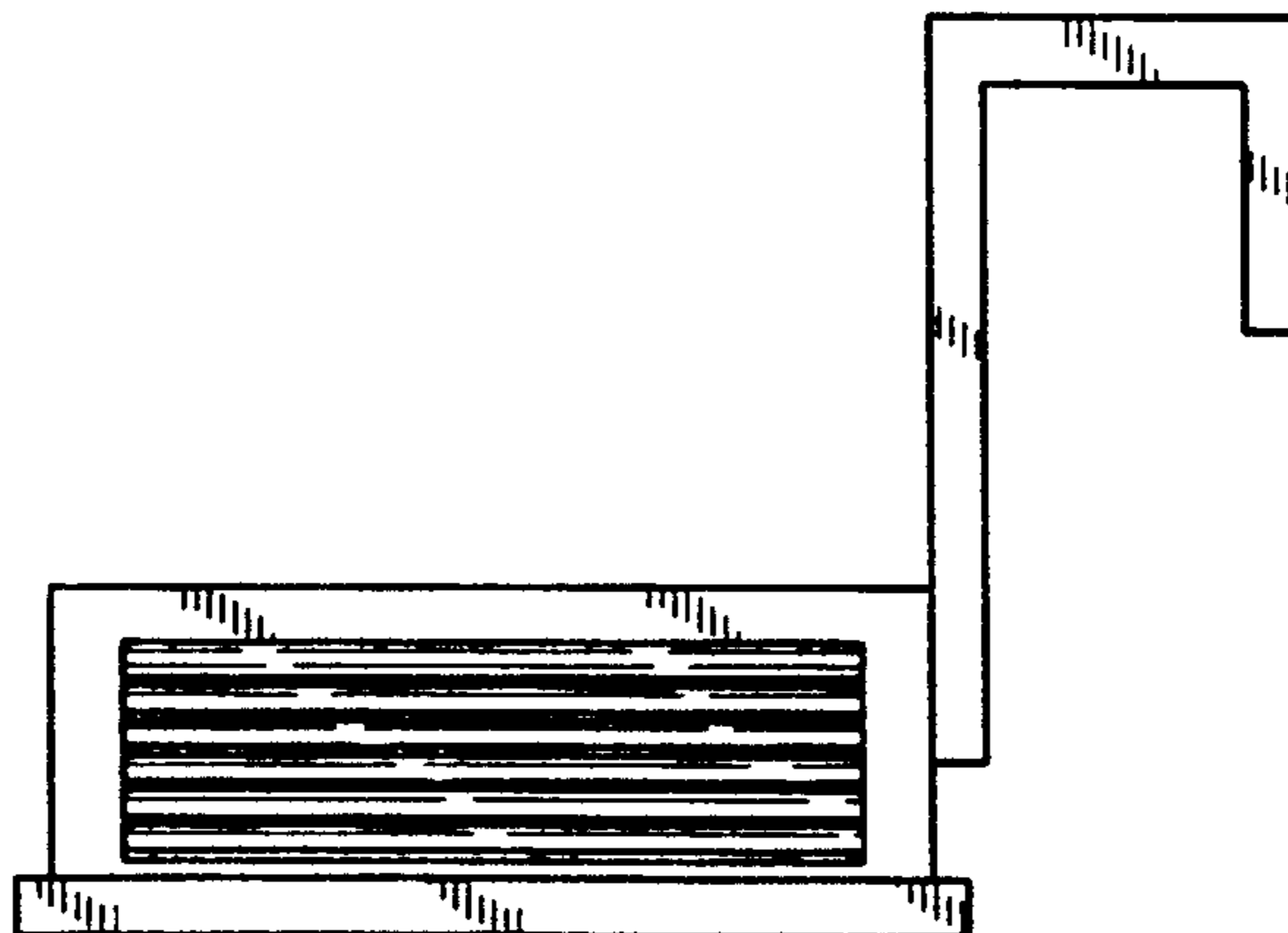

FIG. 5

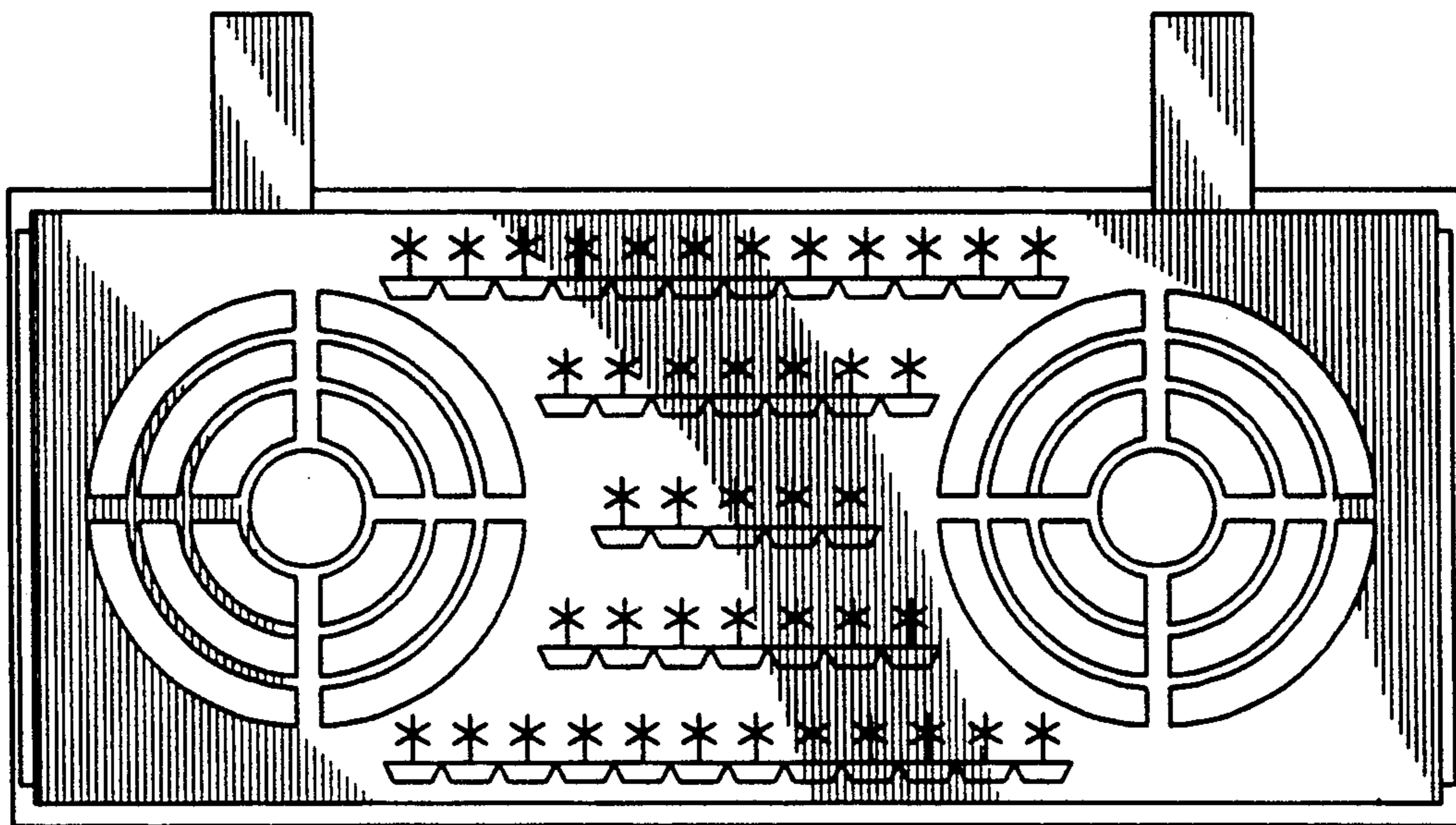

FIG. 6

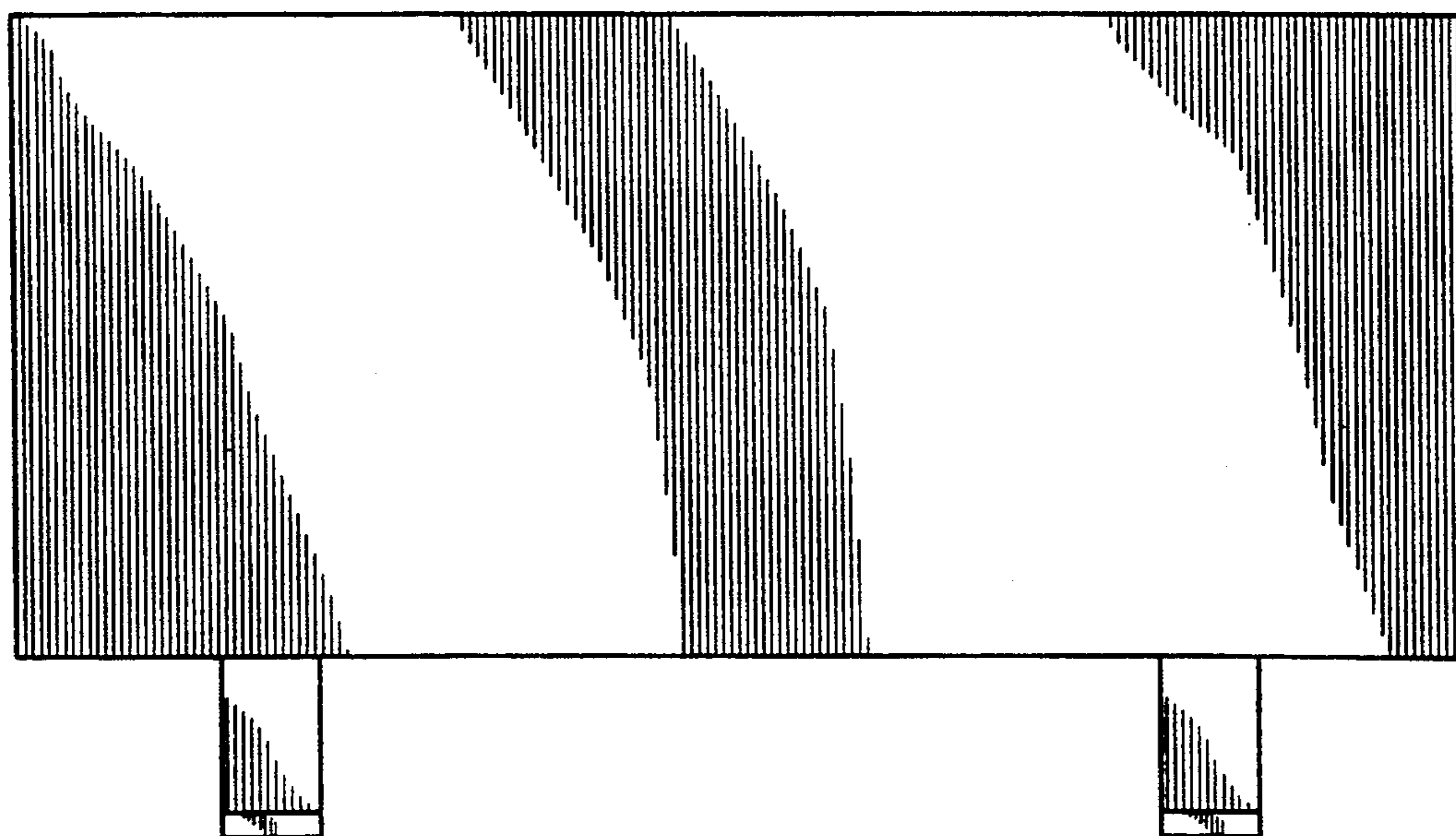

FIG. 7

