



US00D330168S

# United States Patent [19]

[11] Patent Number: Des. 330,168

Stoian

[45] Date of Patent: \*\* Oct. 13, 1992

[54] GAME APPARATUS

[76] Inventor: Michael J. Stoian, Box 38, Mazenod, Saskatchewan, Canada, S0H 2Y0

[\*\*] Term: 14 Years

[21] Appl. No.: 601,055

[22] Filed: Oct. 22, 1990

[30]

### Foreign Application Priority Data

May 25, 1990 [CA] Canada ..... 2505902

[52] U.S. Cl. .... D10/46.1

[58] Field of Search ..... D10/46.1; D21/41; 273/268; 235/90

[56] References Cited

### U.S. PATENT DOCUMENTS

D. 136,008 7/1943 Brooks ..... D10/46.1

D. 271,118 10/1983 Persch ..... D21/41

D. 311,707 10/1990 Clements ..... D10/46.1

D. 323,829 2/1992 Russell ..... D21/41

2,558,170 6/1951 Byrd, Jr. .... 235/90

3,989,243 11/1976 Breslow ..... 273/268 X

### FOREIGN PATENT DOCUMENTS

2282897 1/1991 United Kingdom ..... 273/268

Primary Examiner—Bernard Ansher  
Assistant Examiner—Prabhakar Deshmukh  
Attorney, Agent, or Firm—Murray E. Thrift; Adrian D. Battison; Stanley G. Ade

### [57] CLAIM

The ornamental design for a game apparatus, as shown.

### DESCRIPTION

FIG. 1 is a perspective view of a game apparatus showing my new design;  
FIG. 2 is a right side elevational view thereof;  
FIG. 3 is a left side elevational view thereof;  
FIG. 4 is a top plan view thereof;  
FIG. 5 is a rear elevational view thereof;  
FIG. 6 is a bottom plan view thereof; and,  
FIG. 7 is a front elevational view thereof.

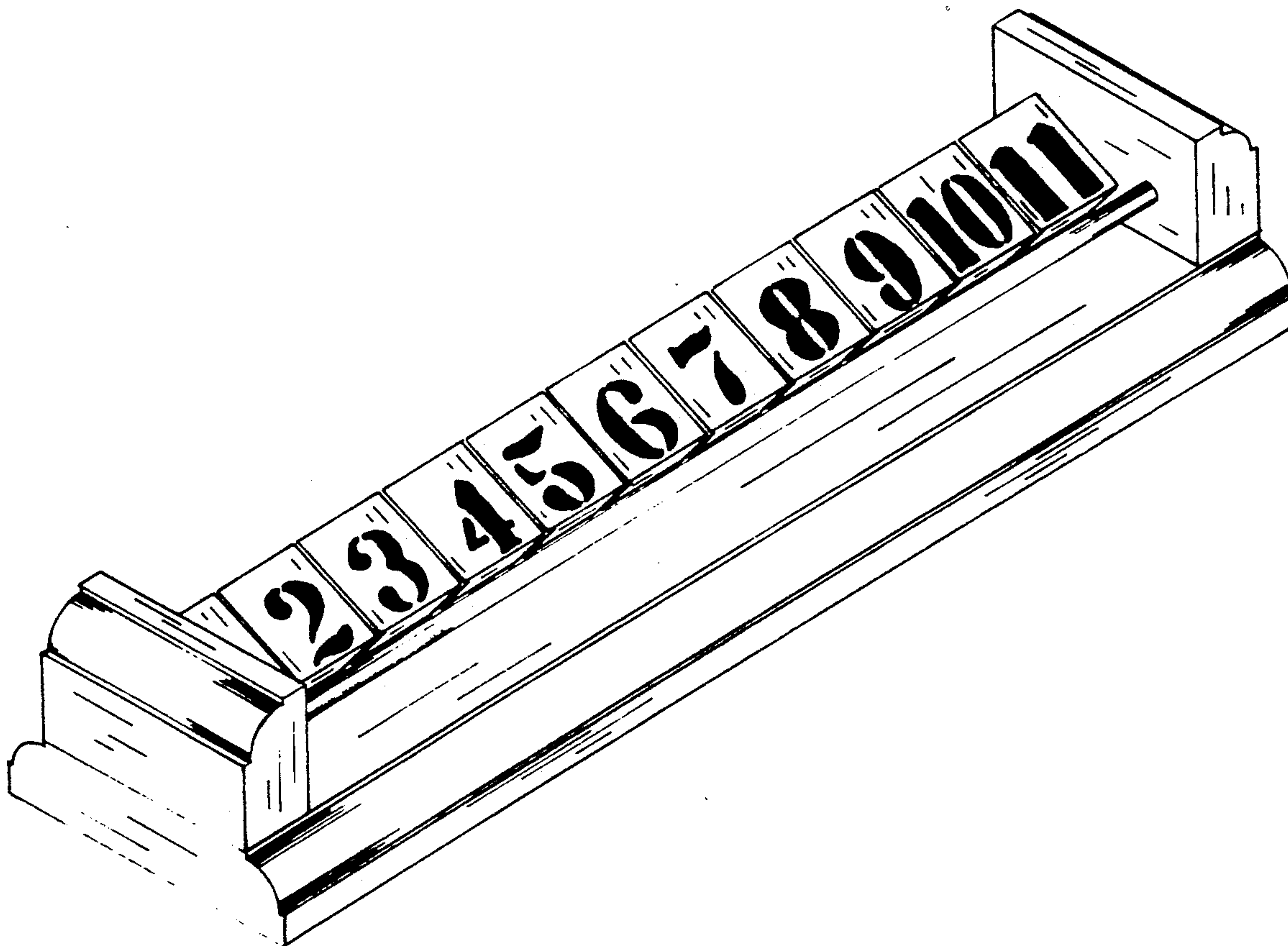

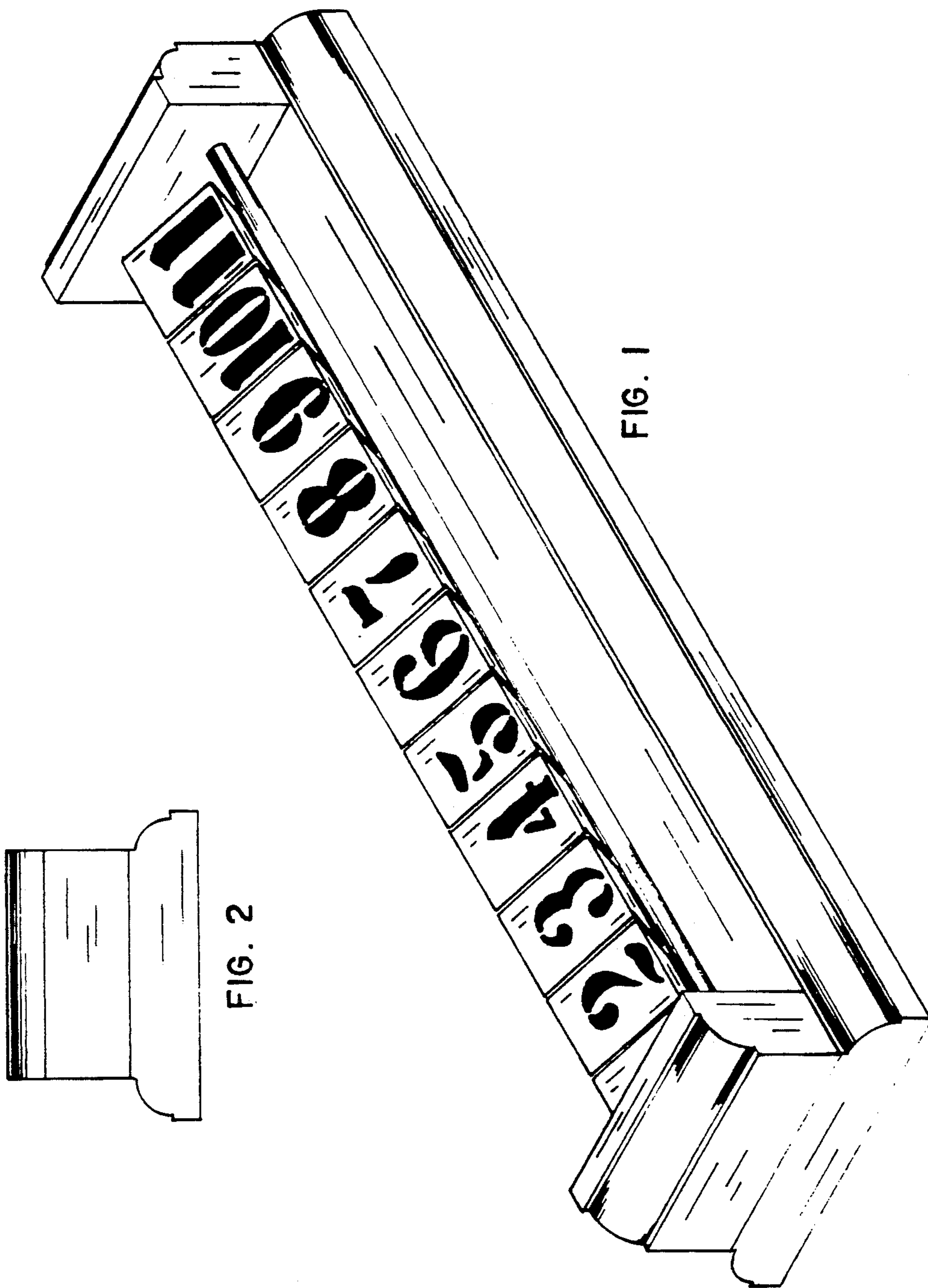

FIG. 1

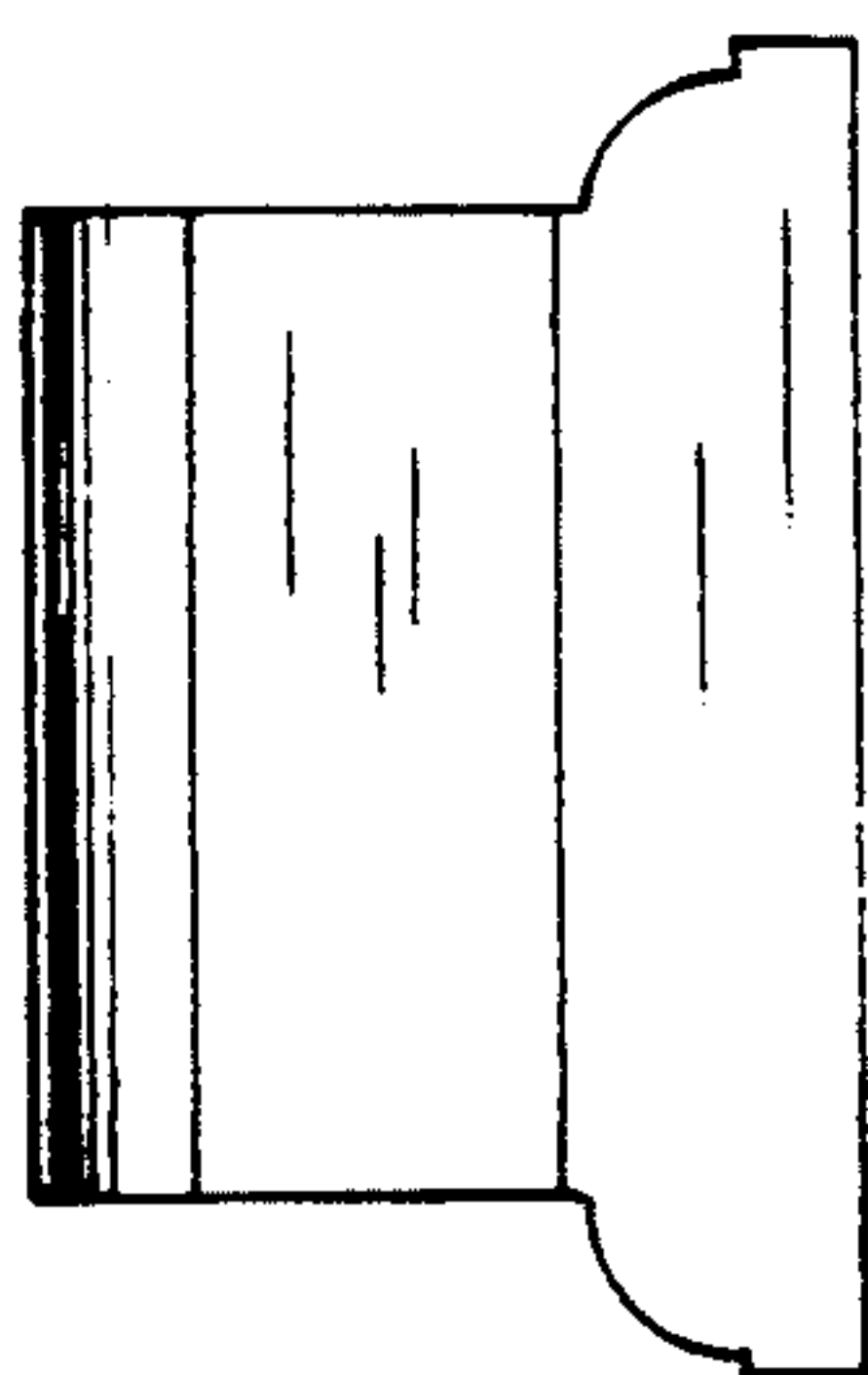

FIG. 2

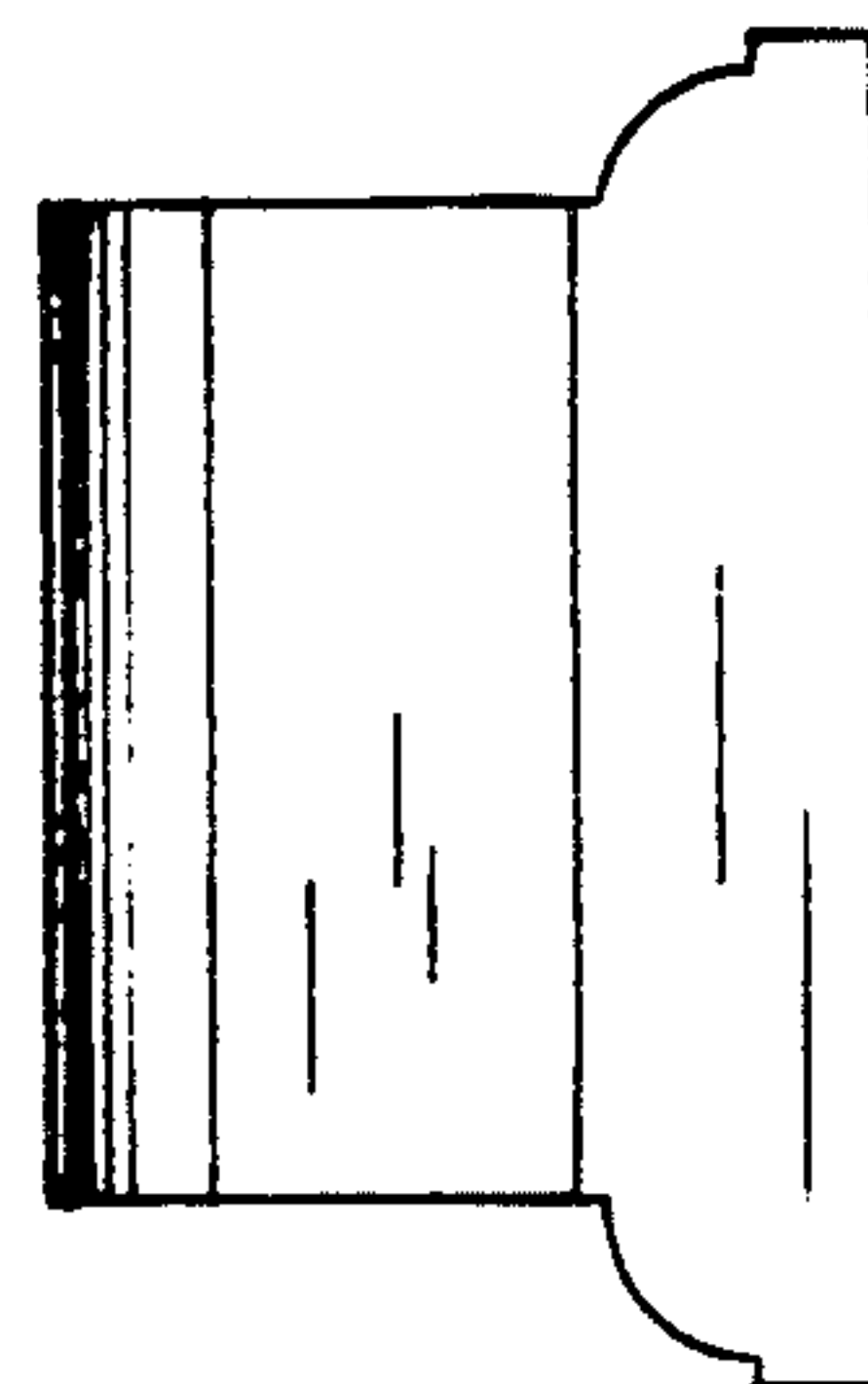

FIG. 3

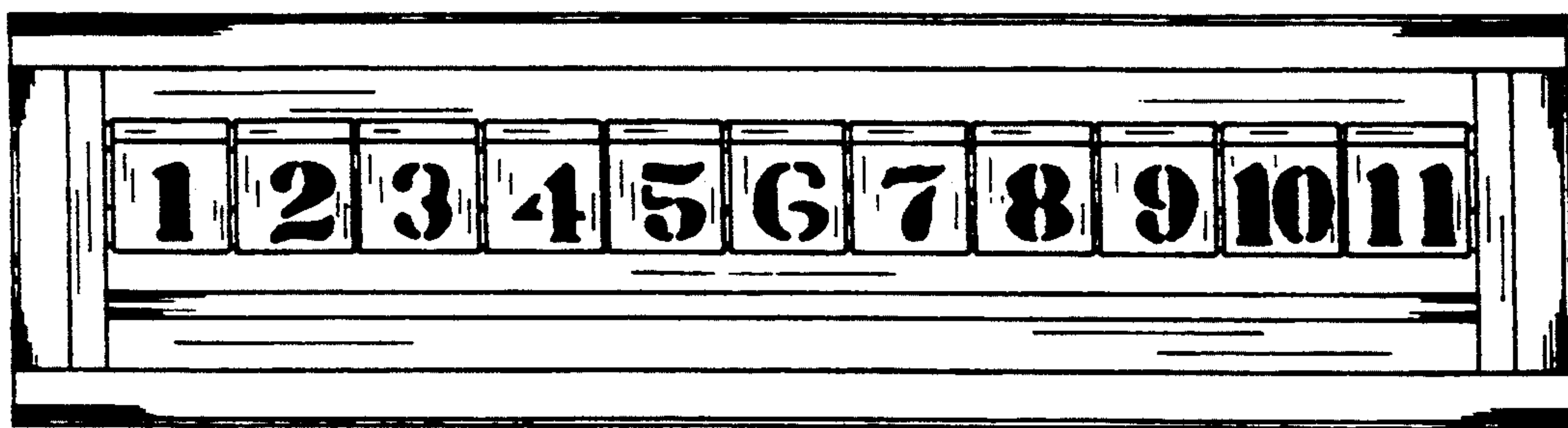

FIG. 4

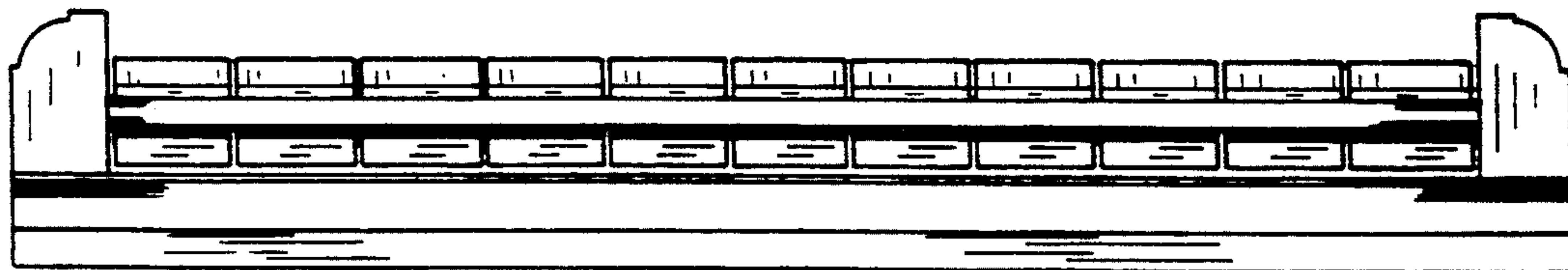

FIG. 5

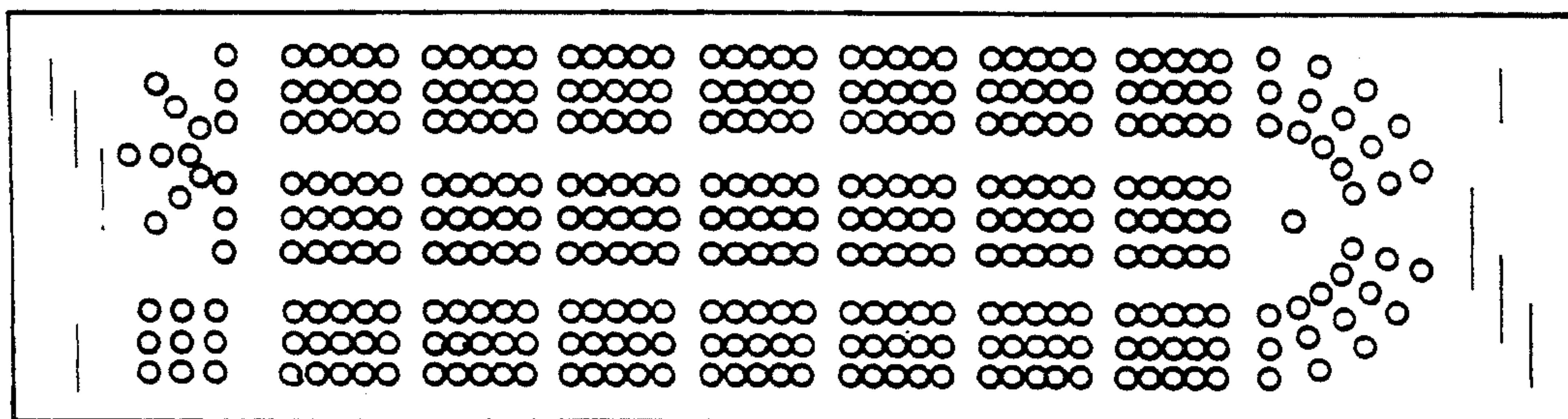

FIG. 6

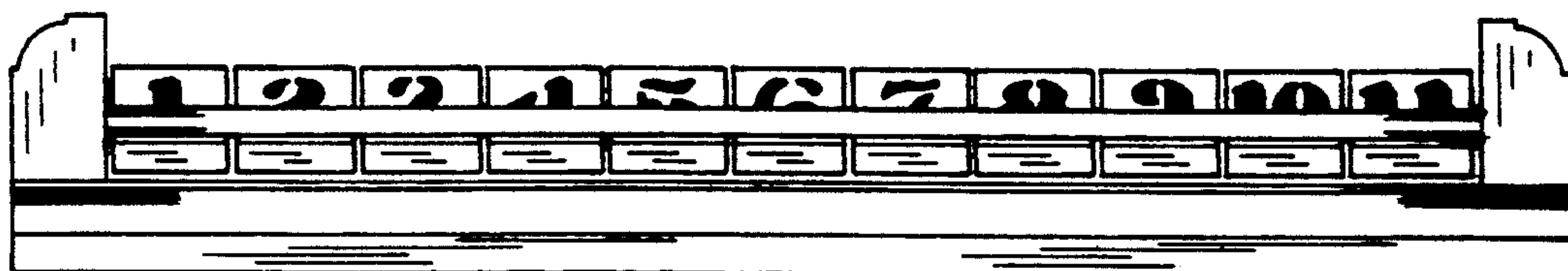

FIG. 7