



US00D330099S

United States Patent [19]

[11] Patent Number: **Des. 330,099**

Sutherland

[45] Date of Patent: **** Oct. 6, 1992**

[54] **PET WATERER**

2124881 2/1984 United Kingdom 119/52.1

[75] Inventor: **Robert G. Sutherland**, St. Paul, Minn.

OTHER PUBLICATIONS

[73] Assignee: **Kennel Spring Inc.**, St. Paul, Minn.

Omaha Vaccine Company; 1985; p. 109, Item Dog Feeder, No. 101, #08746.

[**] Term: **14 Years**

Pedigrees The Pet Catalog, item Pooch and Kitty Feeder #H30-0018.

[21] Appl. No.: **639,720**

Photographs which represent the closest prior art known to the applicant.

[22] Filed: **Jan. 10, 1991**

[52] U.S. Cl. **D30/132**

[58] Field of Search 119/17, 18, 24-26, 119/51.1, 51.03, 51.5, 51.11-51.12, 51.14-51.15, 52.1, 52.3-52.4, 53, 56.1-56.2, 57.1, 57.6-57.7, 61, 63, 72, 72.5; D30/119, 121-122, 124-133; 222/650; 220/525, 502, 254

Primary Examiner—A. Hugo Word

Assistant Examiner—Cathy Anne MacCormac

Attorney, Agent, or Firm—Merchant, Gould, Smith, Edell, Welter & Schmidt

[56] References Cited

U.S. PATENT DOCUMENTS

- D. 195,165 5/1963 Johnson D30/121
- D. 196,170 9/1963 Fenton D30/121
- D. 209,972 1/1968 Furman D30/121
- D. 278,169 3/1985 Cargile, Jr. D30/124
- D. 299,072 12/1988 Daniels D30/101
- 430,195 6/1890 Reimers 119/61
- 1,398,041 11/1921 Pfeifer 119/52.1
- 1,450,258 4/1923 Jacobus et al. D30/121
- 1,469,013 9/1923 Jacobus 119/52.1
- 4,722,300 2/1988 Walker et al. 222/650

FOREIGN PATENT DOCUMENTS

- 3146181 5/1983 Fed. Rep. of Germany ... 119/51.03

[57] CLAIM

The ornamental design for a pet waterer, as shown and described.

DESCRIPTION

FIG. 1 is a top, front, and left side perspective view of a pet waterer showing my new design;

FIG. 2 is a top, rear and right side perspective view thereof;

FIG. 3 is a front elevational view thereof;

FIG. 4 is a rear elevational view thereof;

FIG. 5 is a right side elevational view thereof;

FIG. 6 is a left side elevational view thereof;

FIG. 7 is a top plan view thereof; and,

FIG. 8 is a bottom plan view thereof.

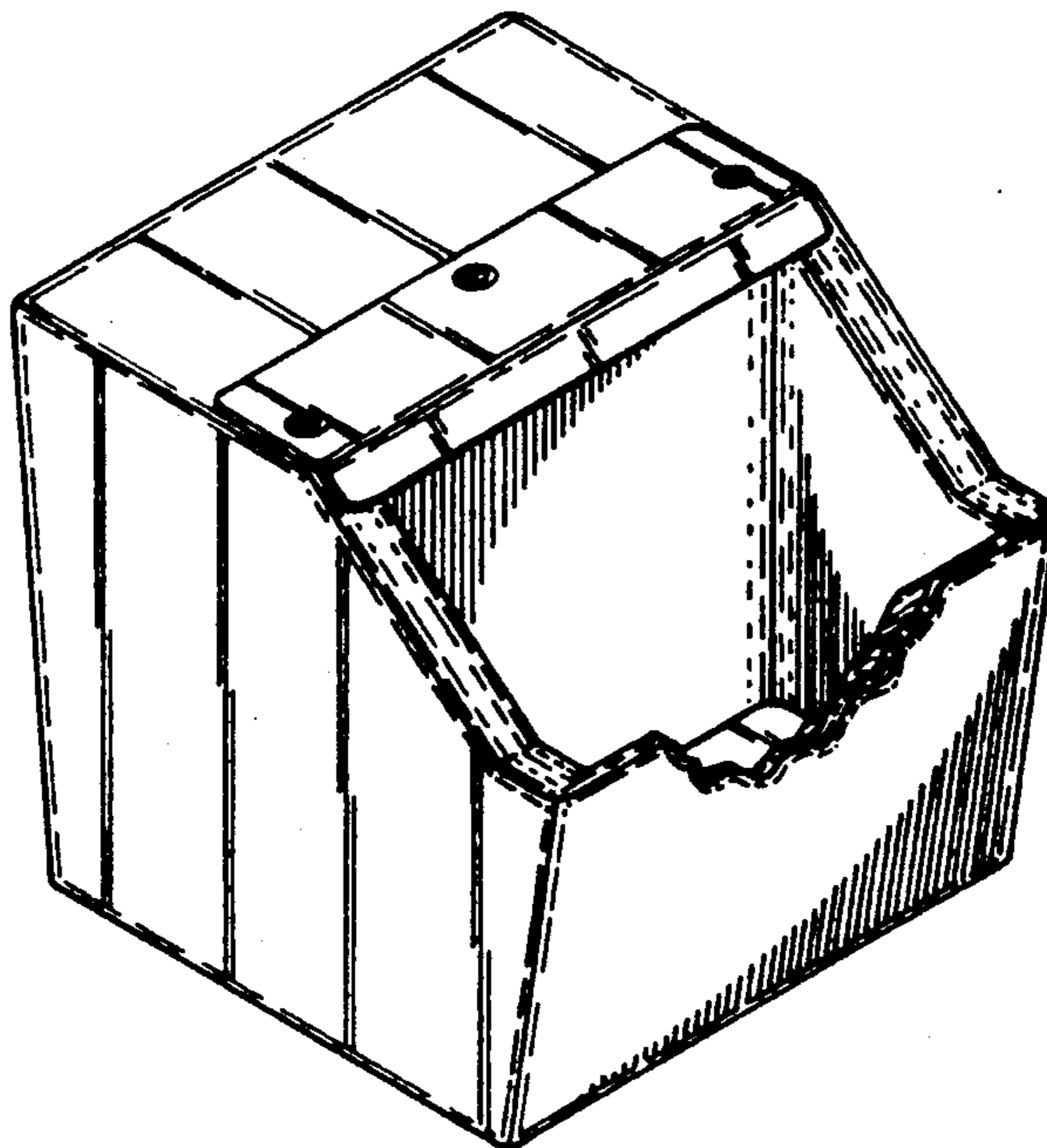

FIG. 1

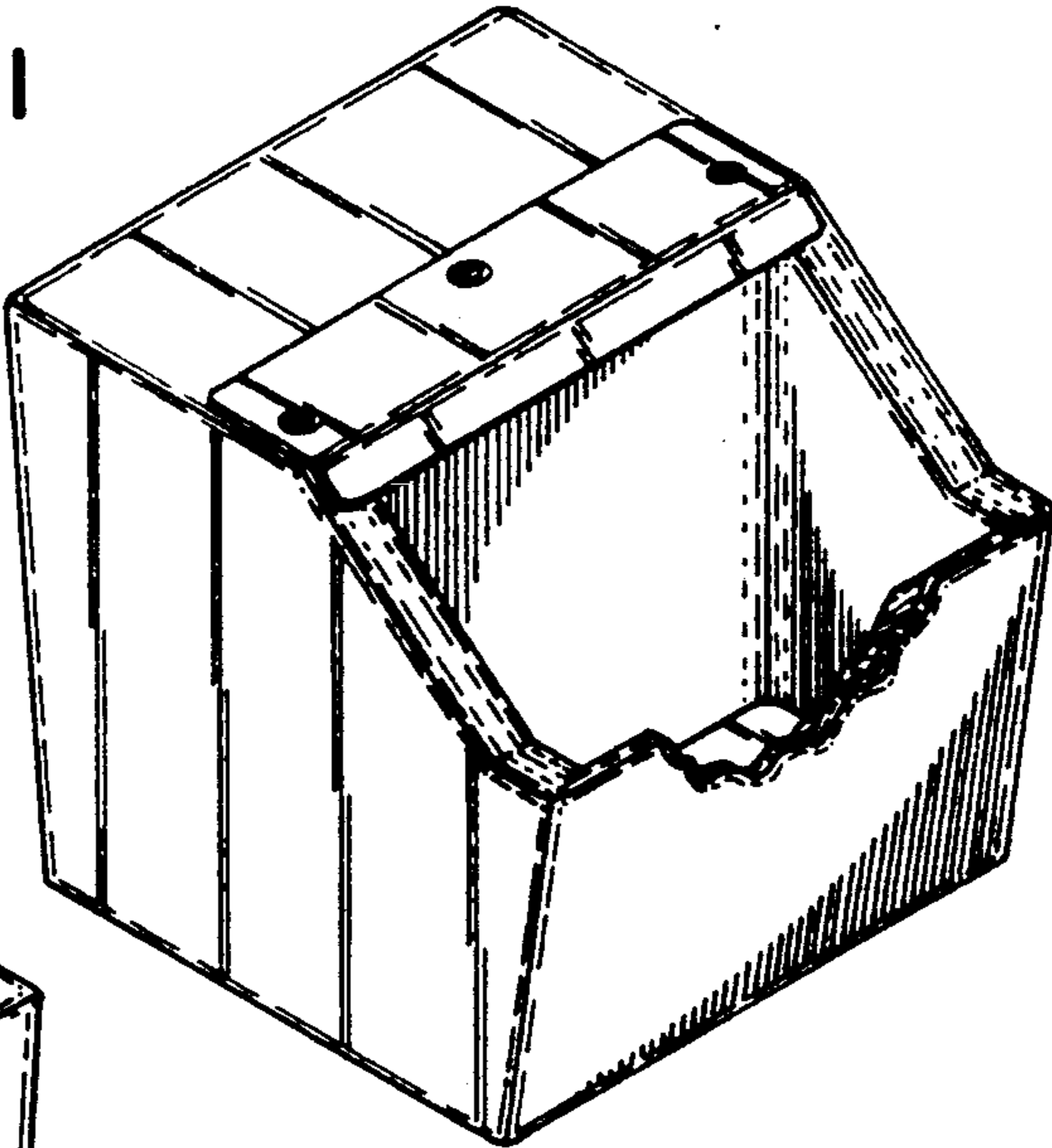

FIG. 2

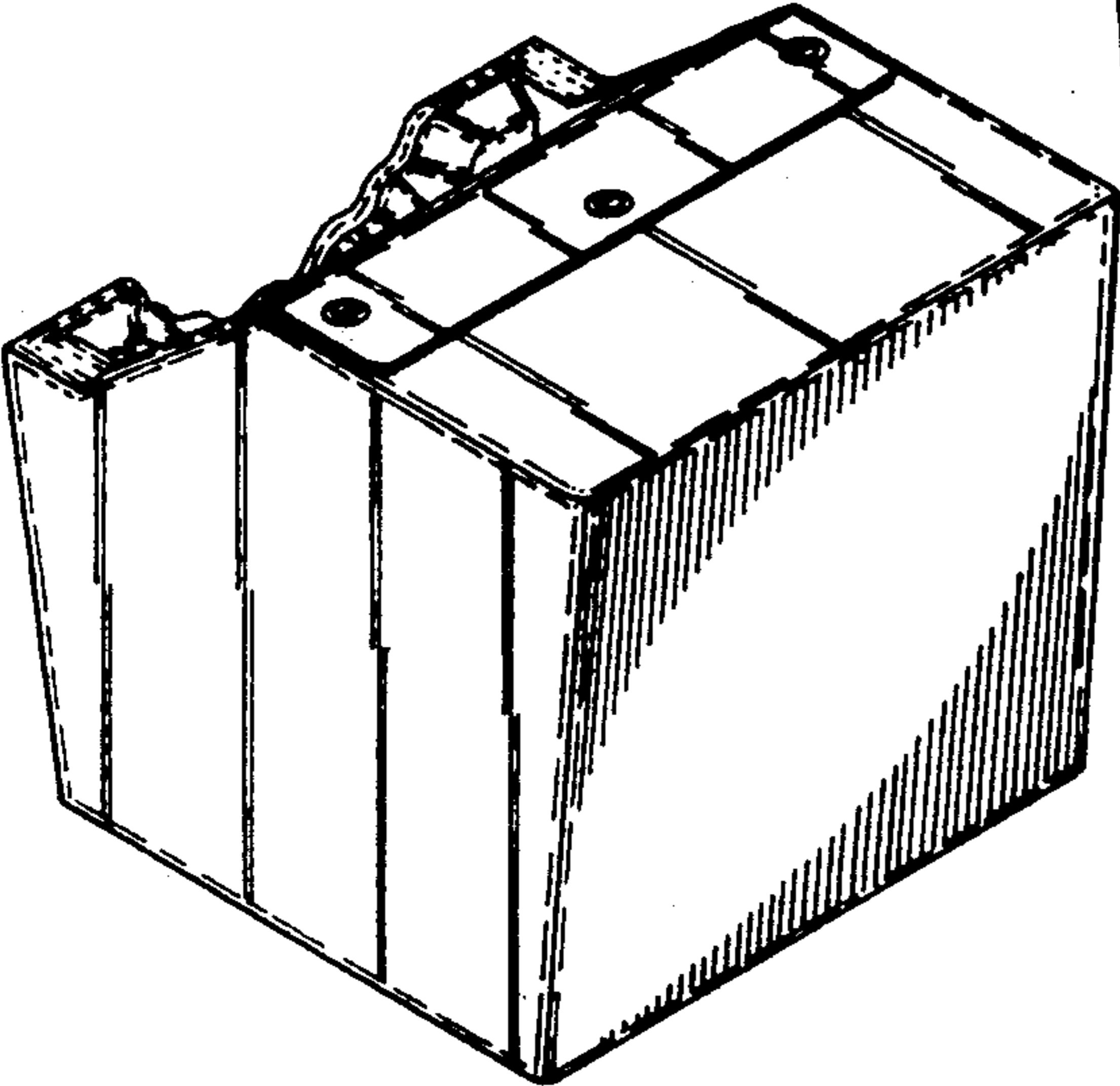

FIG. 3

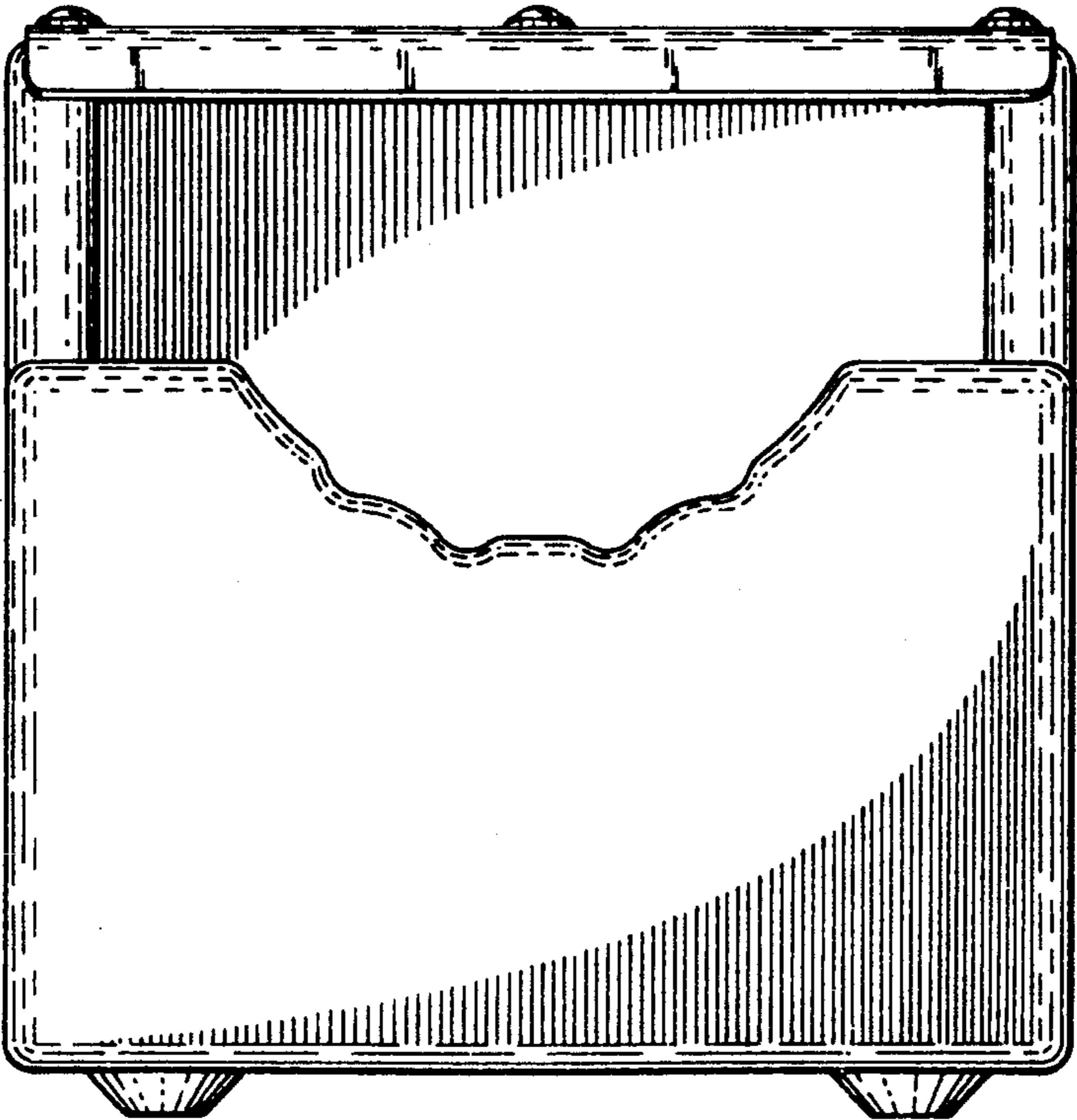

FIG. 4

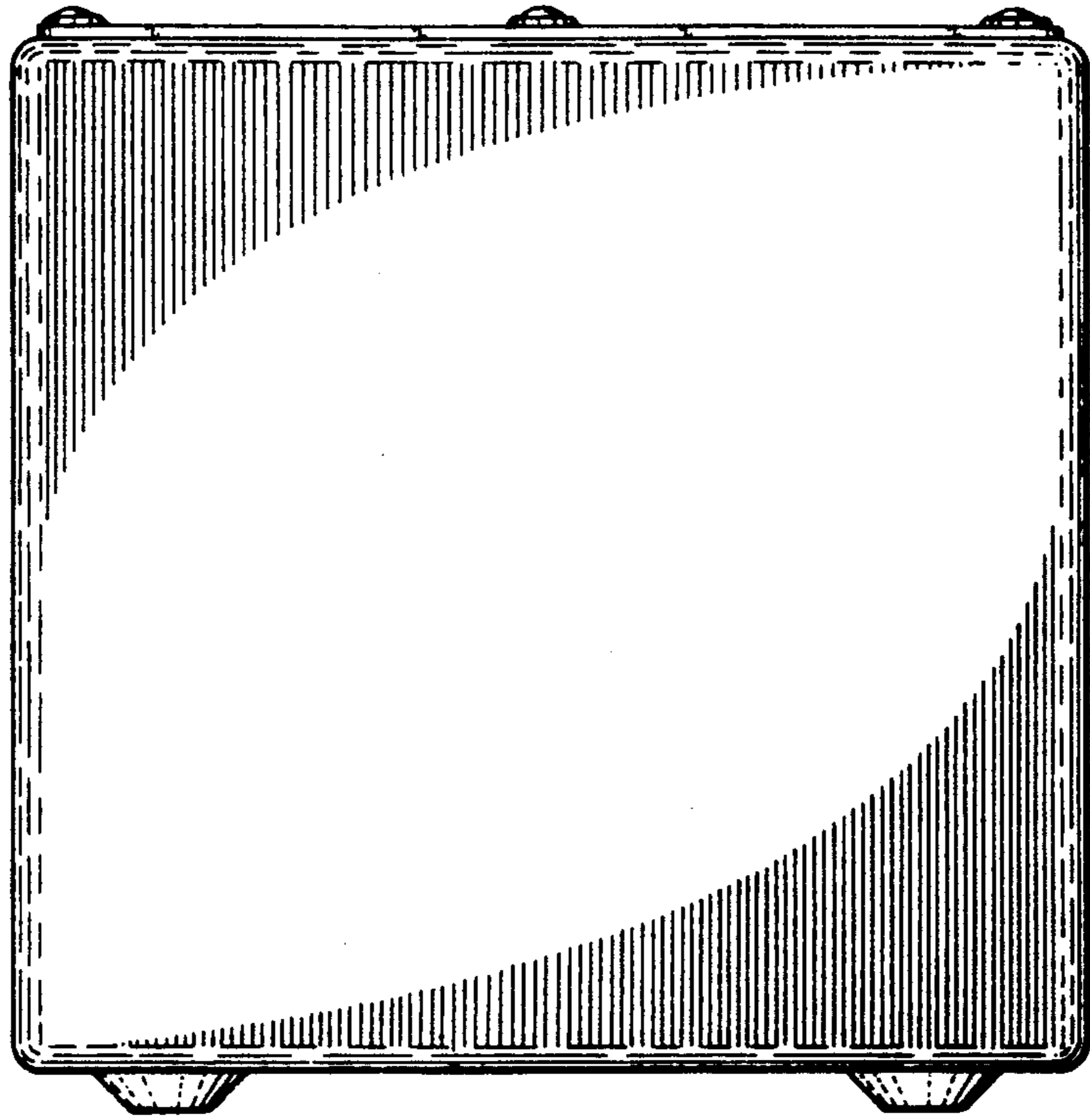
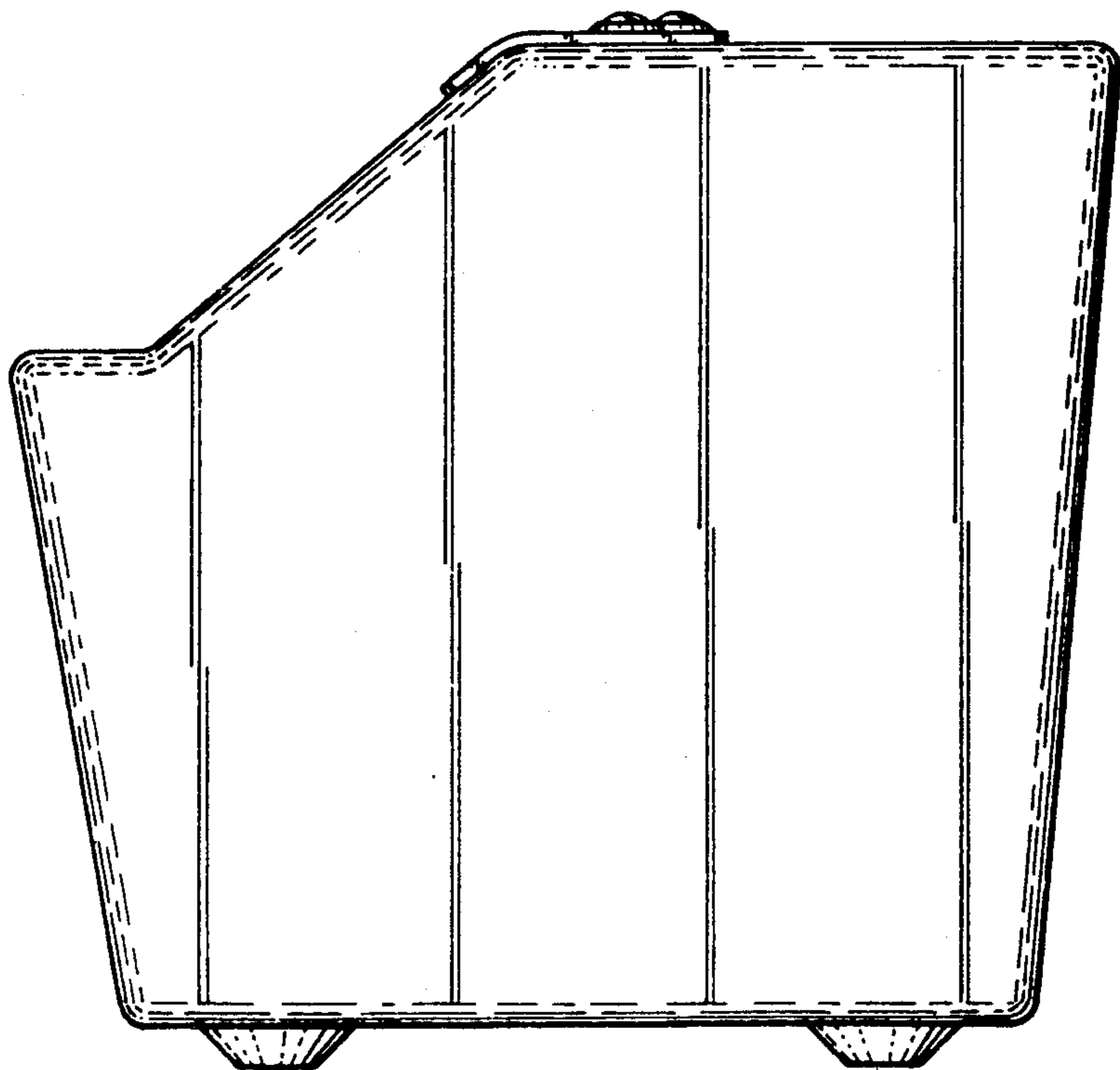

FIG. 5



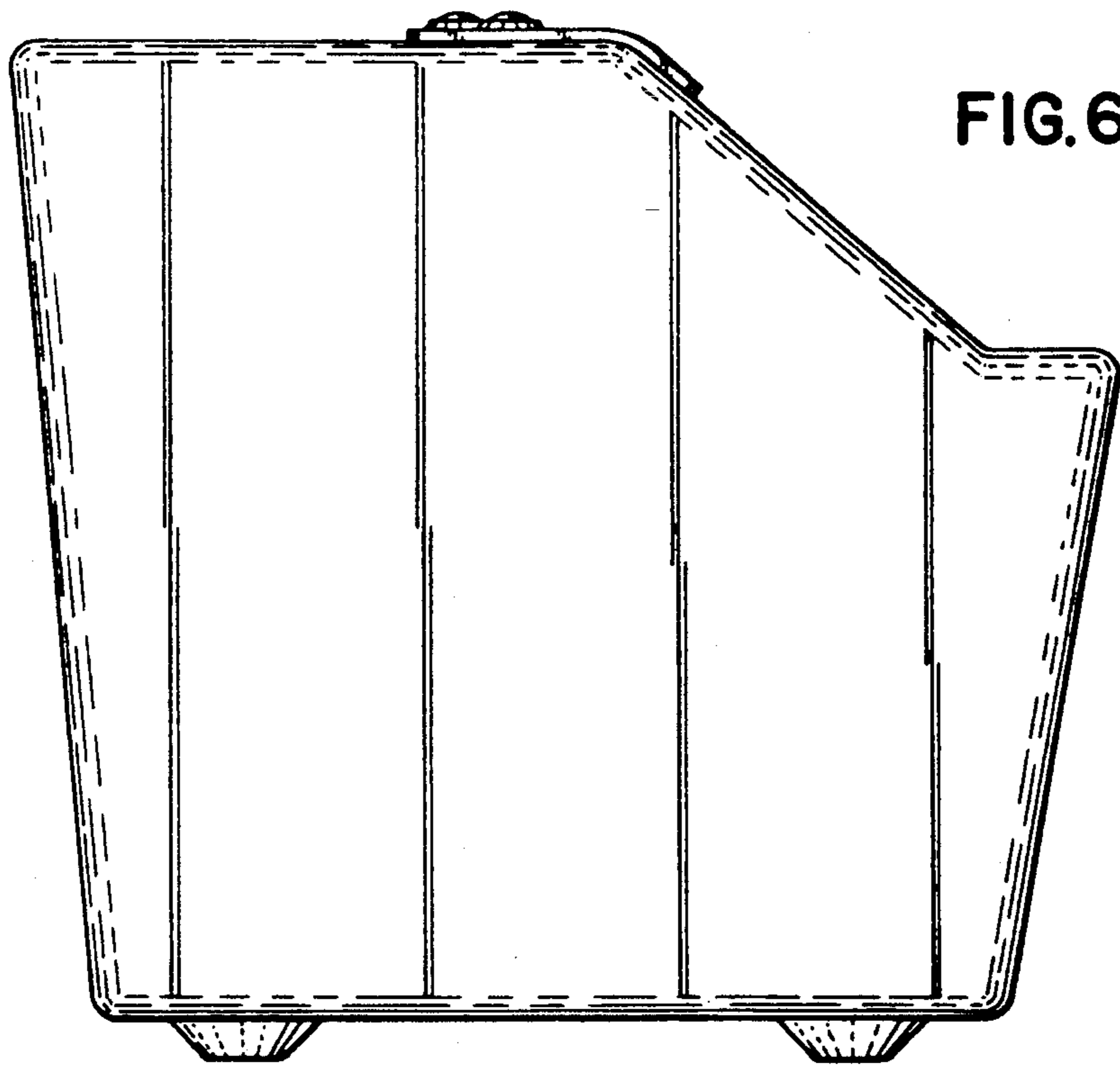

FIG. 7

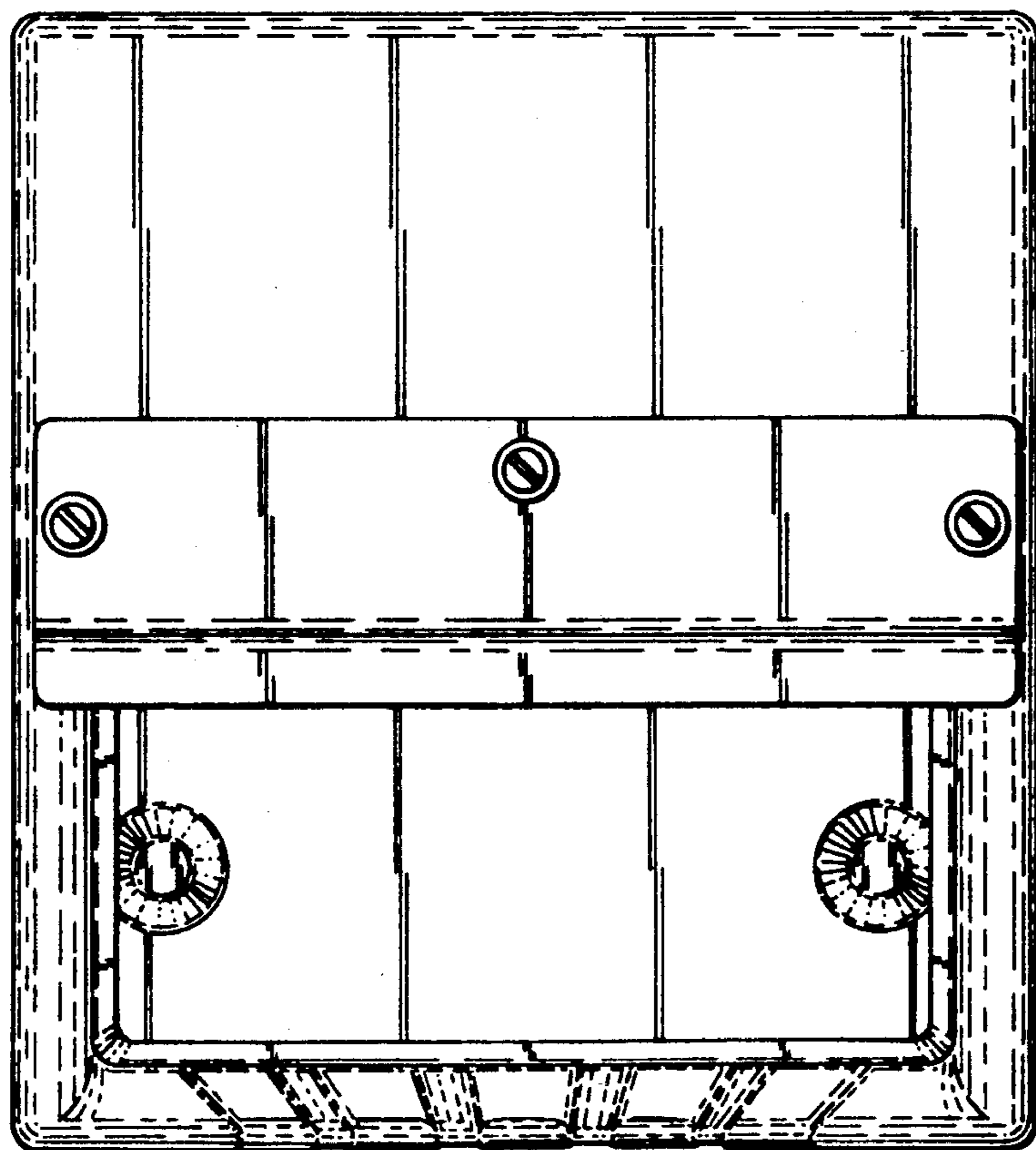

FIG. 8

