



US00D330090S

United States Patent [19]

[11] Patent Number: **Des. 330,090**

Walter et al.

[45] Date of Patent: **** Oct. 6, 1992**

[54] **COMBINED SHELF AND FLUORESCENT LIGHTING FIXTURE**

[75] Inventors: **Herbert Walter, Muellheim, Fed. Rep. of Germany; Peter Fuchs, Muttenz, Switzerland**

[73] Assignee: **Fehlbaum & Co., Riehen, Switzerland**

[**] Term: **14 Years**

[21] Appl. No.: **571,882**

[22] Filed: **Aug. 23, 1990**

[30] **Foreign Application Priority Data**

Feb. 26, 1990 [IB] Int'l Pat. Institute **DM/015991**

[52] U.S. Cl. **D26/51; D6/511; D26/76**

[58] Field of Search **D26/72, 74-92; 362/374, 147, 33, 222, 223, 404-408, 362, 367, 432, 127; D6/399, 511, 553, 567, 574**

[56] **References Cited**

U.S. PATENT DOCUMENTS

D. 79,072 7/1929 Green **D26/51**

D. 146,982	6/1947	Phillips	D26/51
D. 148,208	12/1947	Arenberg	D26/51
D. 205,192	7/1966	Shearin	D26/51
D. 268,367	3/1983	Paquette et al.	D26/76
4,323,955	4/1982	Mark	362/223 X
4,689,726	8/1987	Kretzschmar	362/127

Primary Examiner—Susan J. Lucas
Attorney, Agent, or Firm—Ralph W. Selitto, Jr.

[57] **CLAIM**

The ornamental design for a combined shelf and fluorescent lighting fixture, as shown and described.

DESCRIPTION

FIG. 1 is a top perspective view of a combined shelf and fluorescent lighting fixture showing our new design, environmental structure in the form of a support rack being shown in phantom for informational purposes only;

FIG. 2 is a bottom perspective view thereof;

FIG. 3 is a top plan view thereof;

FIG. 4 is a right side elevational view thereof, the left side being a mirror image;

FIG. 5 is a bottom plan view thereof;

FIG. 6 is a front elevational view thereof; and,

FIG. 7 is a rear elevational view thereof.

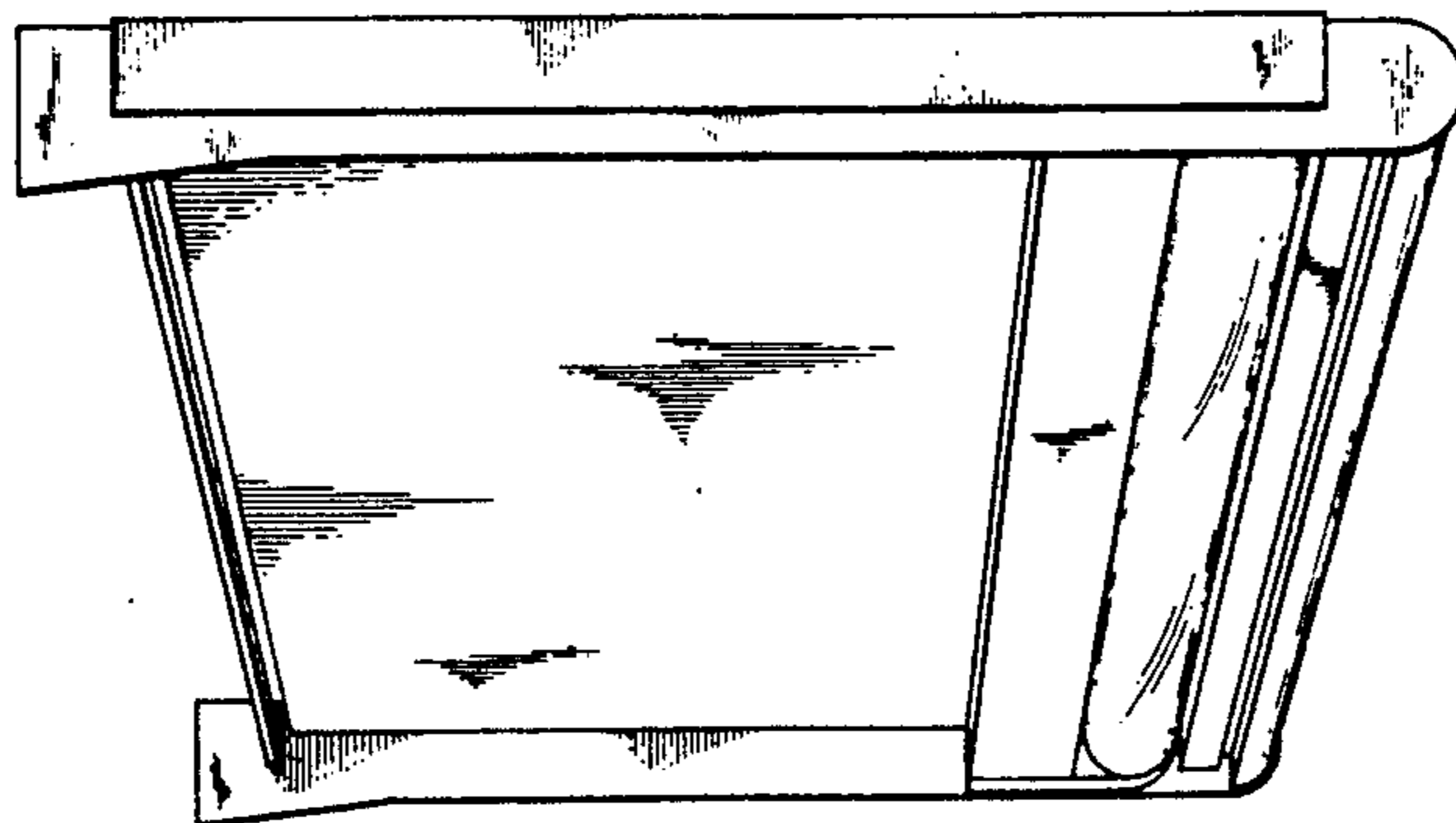
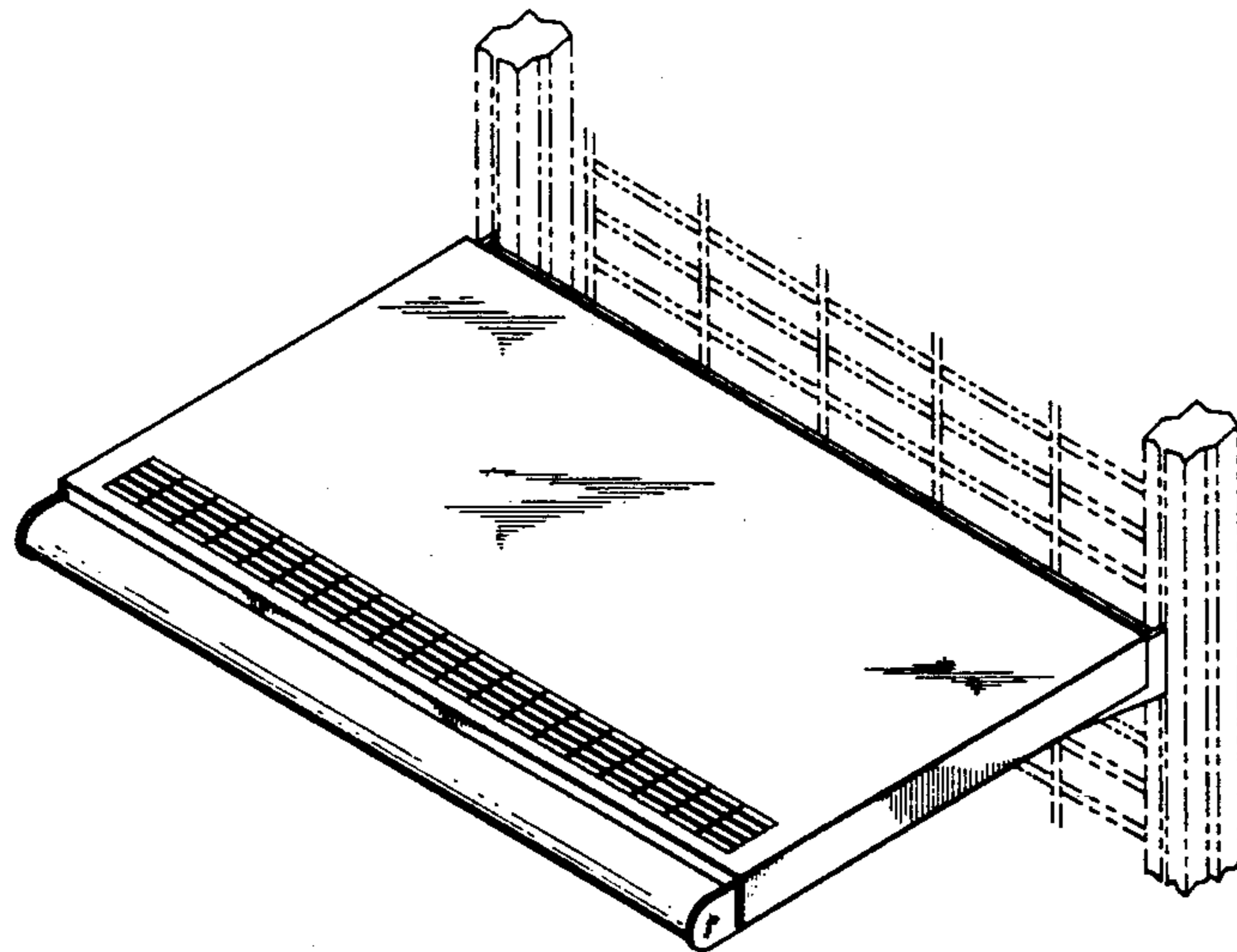

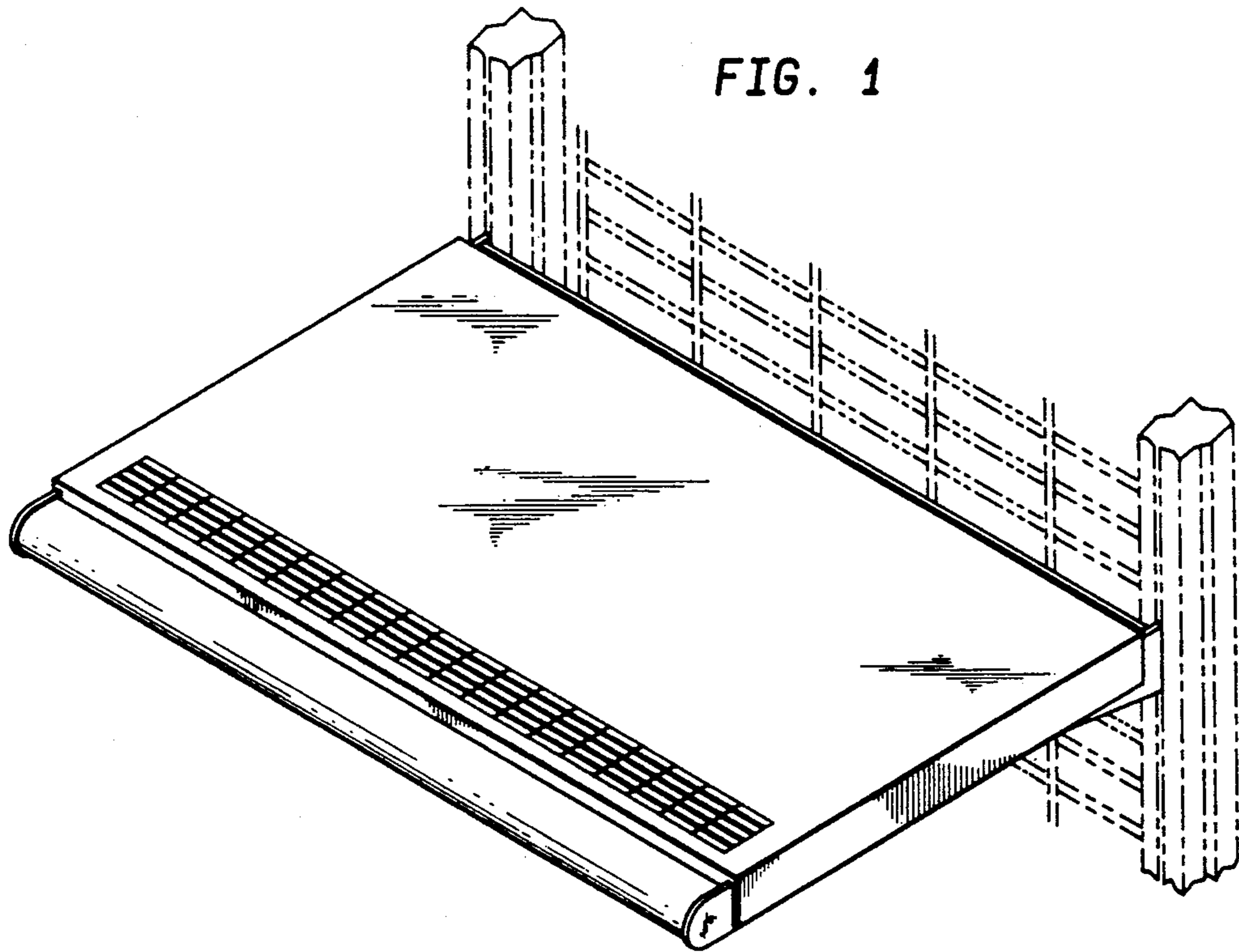

FIG. 2

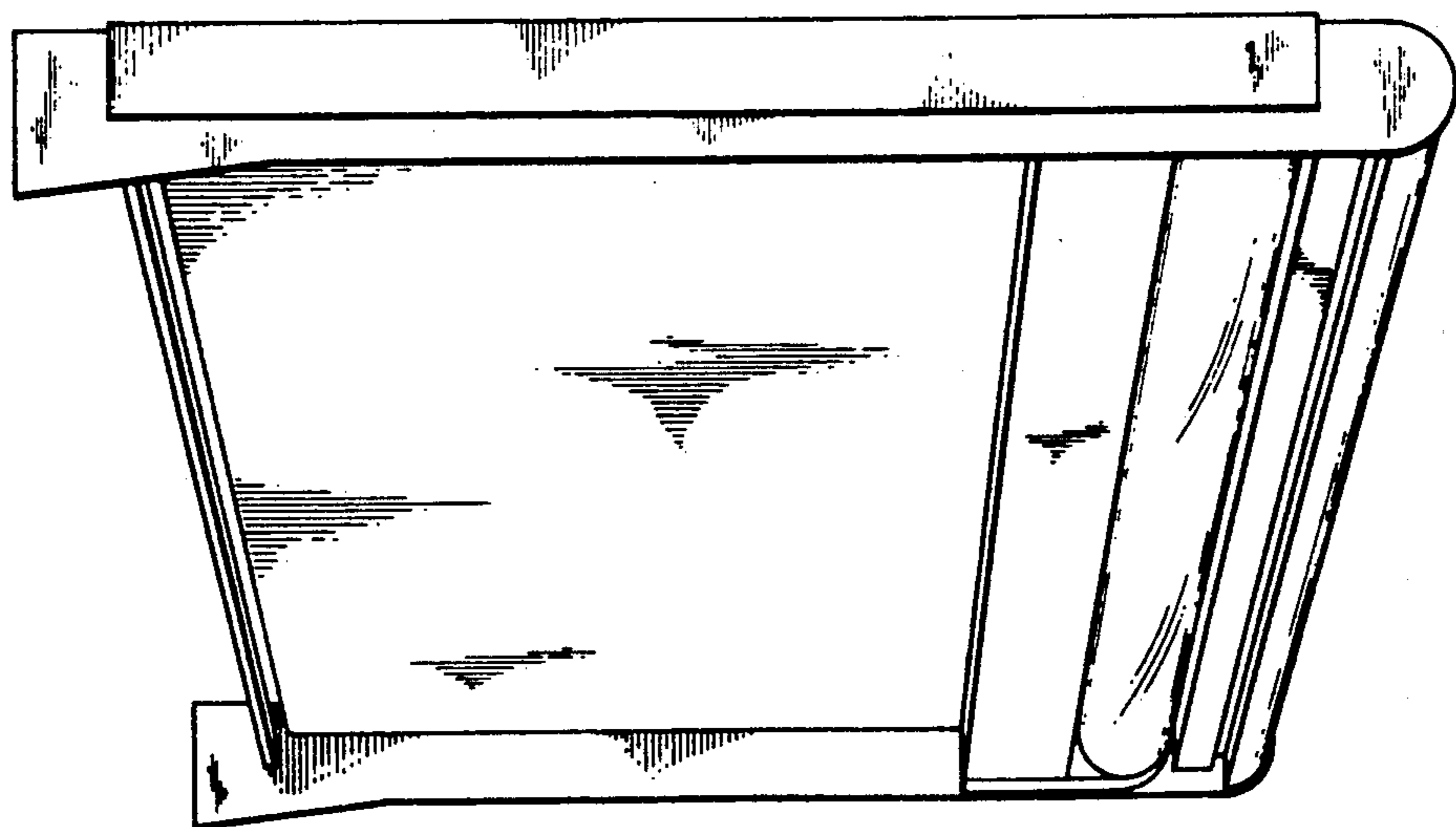

FIG. 3

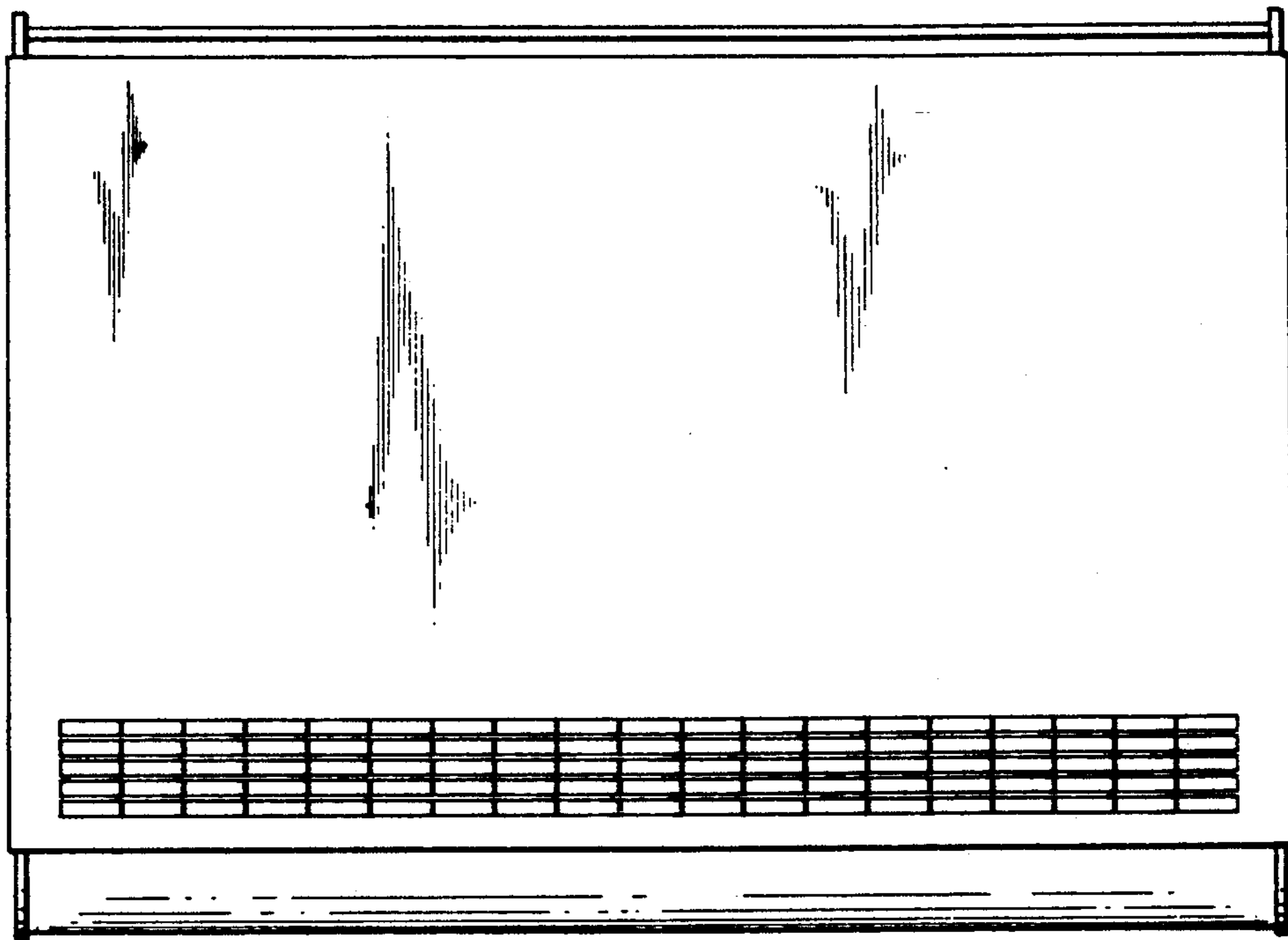

FIG. 4

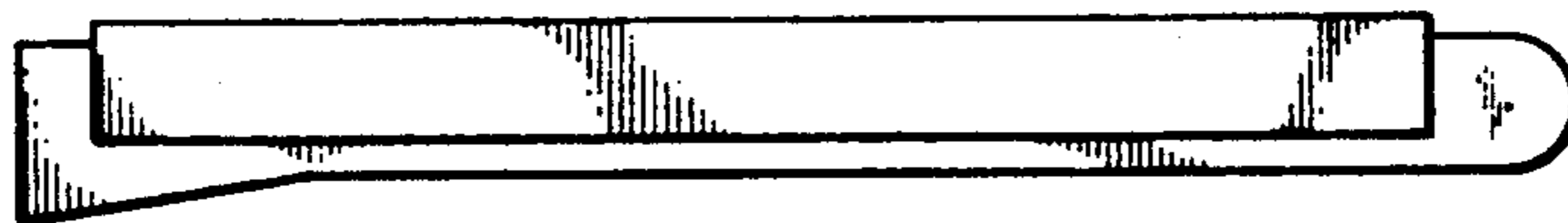

FIG. 5

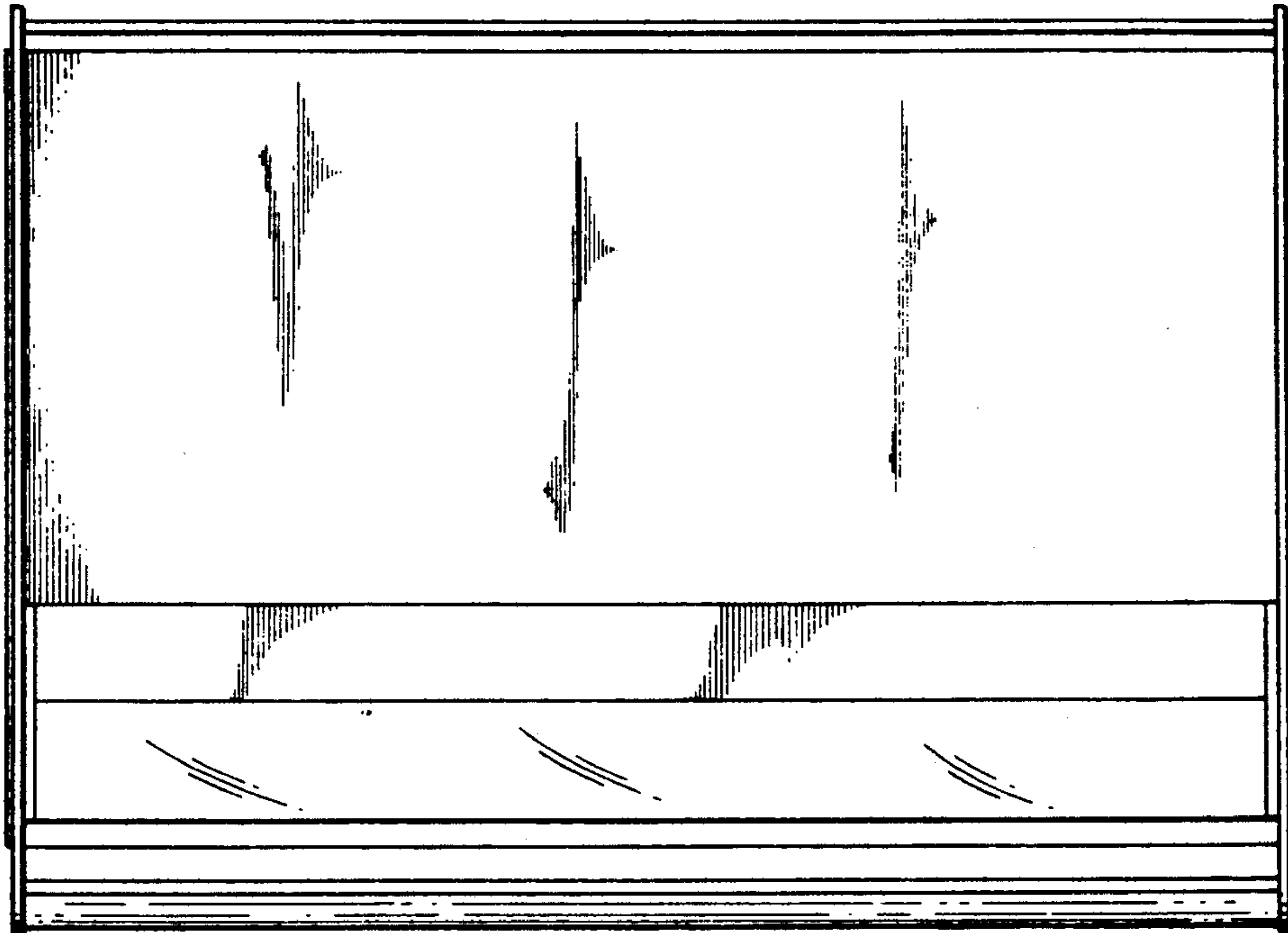

FIG. 6

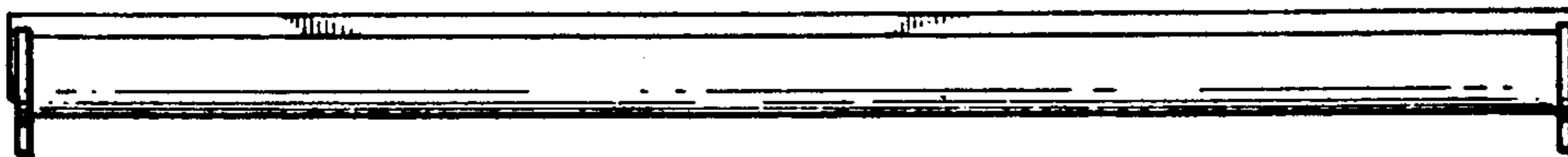

FIG. 7

