



US00D330041S

United States Patent [19]

[11] Patent Number: **Des. 330,041**

Link

[45] Date of Patent: **** Oct. 6, 1992**

[54] **DRUMHEAD**

[75] Inventor: **Horst Link**, Bad Berleburg, Fed. Rep. of Germany

[73] Assignee: **Johs. Link GmbH & Co. KG**, Bad Berleburg, Fed. Rep. of Germany

[**] Term: **14 Years**

[21] Appl. No.: **381,021**

[22] Filed: **Jul. 17, 1989**

[30] **Foreign Application Priority Data**

Jan. 26, 1989 [DE] Fed. Rep. of Germany 8900575

[52] U.S. Cl. **D17/22**

[58] Field of Search D17/22, 99; 84/411, 84/414, 415-420

[56] **References Cited**

U.S. PATENT DOCUMENTS

2,830,484	4/1958	Erwin	84/414
4,254,685	3/1981	Rose	84/414
4,706,540	11/1987	Donohoe	84/414
4,798,121	1/1989	Donohoe	84/414

FOREIGN PATENT DOCUMENTS

1583781	2/1981	United Kingdom	84/414
---------	--------	----------------	--------

OTHER PUBLICATIONS

Tonga Catalog, 1980 (2 pages).
Music Trades, Jan. 1989 p. 39 (Remo Drumheads).

Primary Examiner—Bernard Ansher
Assistant Examiner—Adir Aronovich
Attorney, Agent, or Firm—Anderson Kill Olick & Oshinsky

[57] **CLAIM**

The ornamental design for drumhead, as shown.

DESCRIPTION

FIG. 1 is a top plan view of a drumhead showing my new design;
 FIG. 2 is a top, front perspective view thereof;
 FIG. 3 is a top plan view of a second embodiment of the drumhead disclosed in FIG. 1;
 FIG. 4 is a top, front perspective view thereof;
 FIG. 5 is a top, plan view of a third embodiment of the drumhead disclosed in FIG. 1;
 FIG. 6 is a top, front perspective view thereof;
 FIG. 7 is a top plan of a fourth embodiment of the drumhead disclosed in FIG. 1;
 FIG. 8 is a top, front perspective view thereof;
 FIG. 9 is a fifth embodiment of the drumhead disclosed in FIG. 1;
 FIG. 10 is a top, front perspective view thereof; and,
 FIG. 11 is a side elevational view thereof.

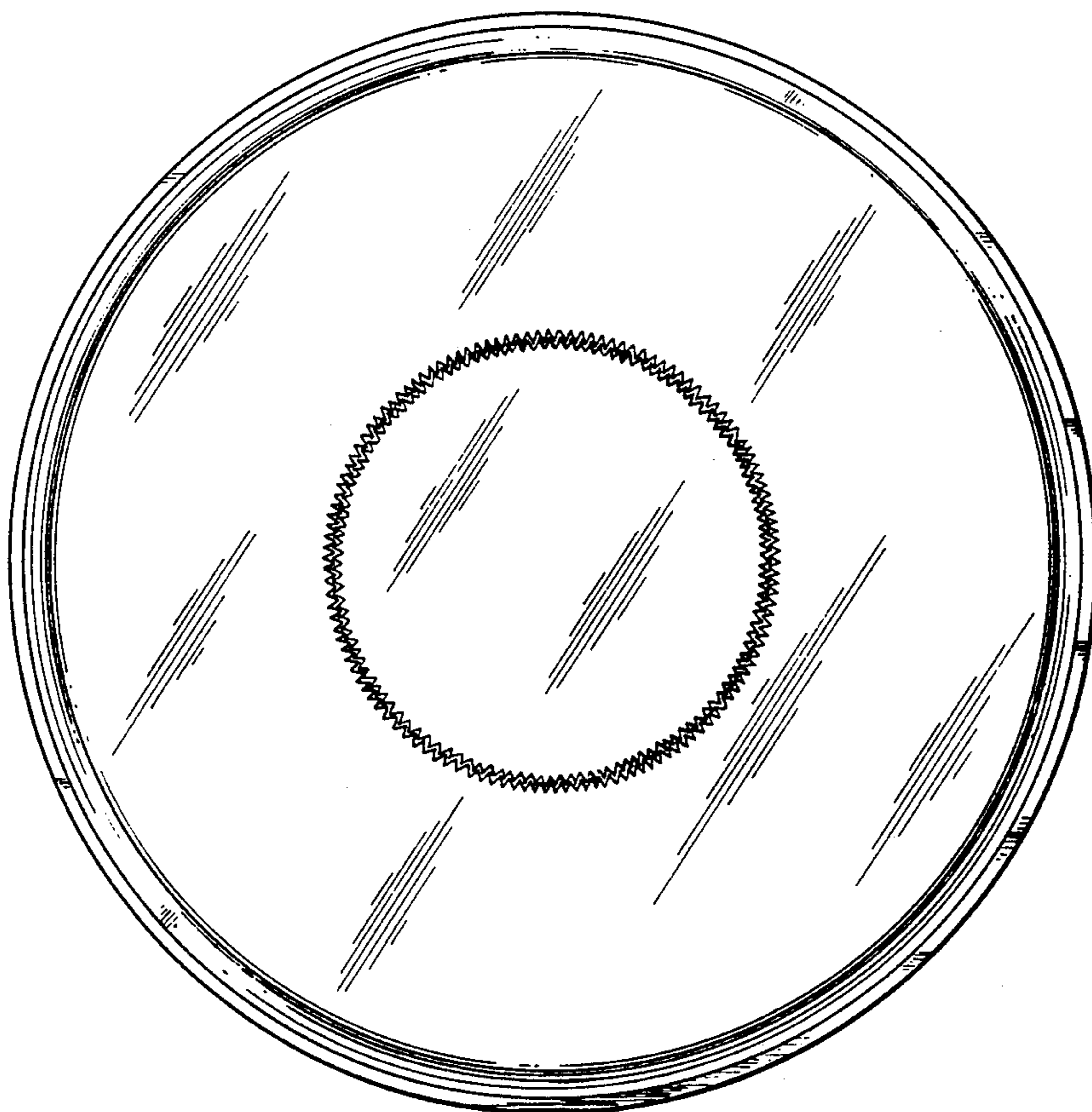

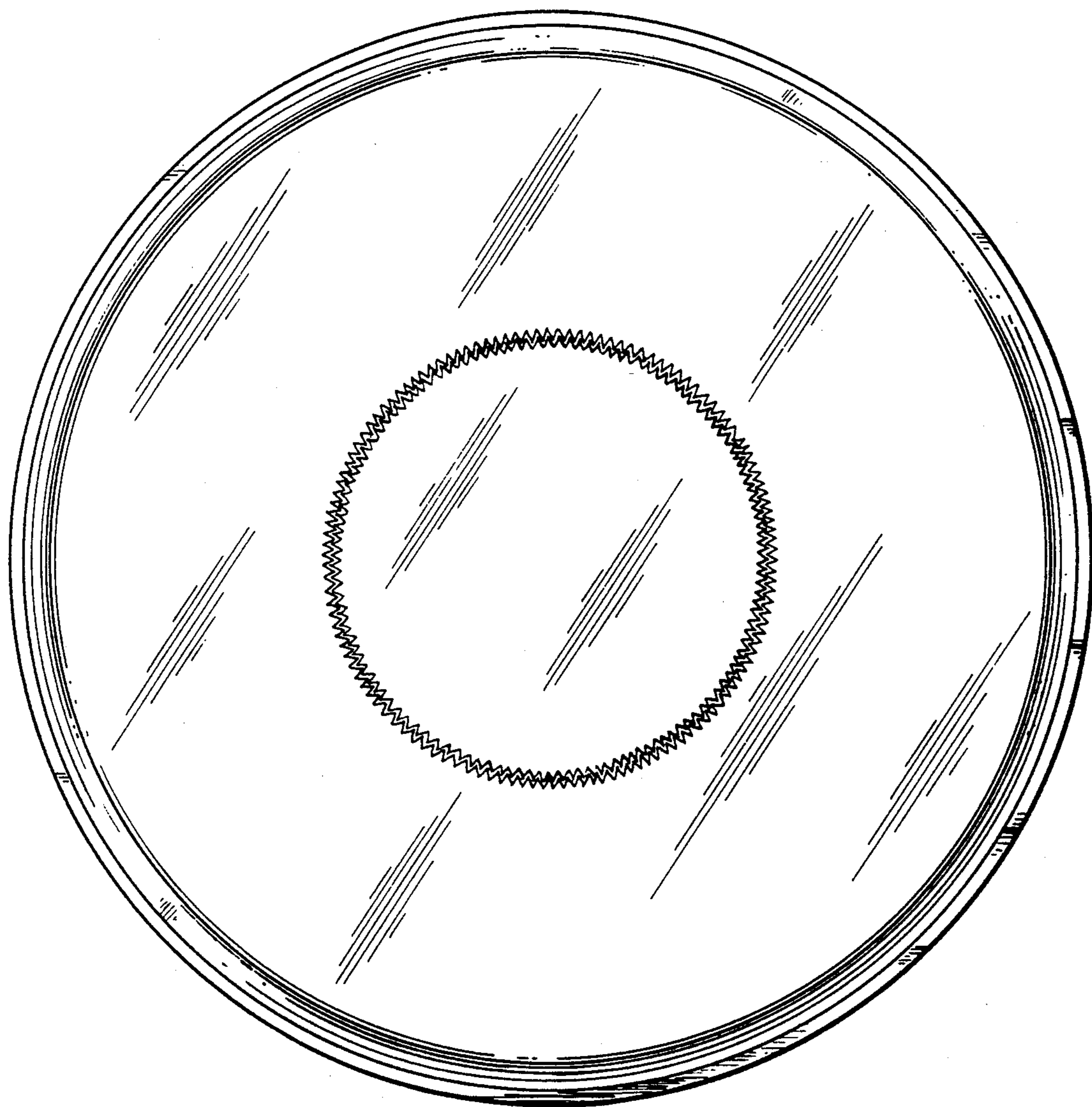

FIG. 1

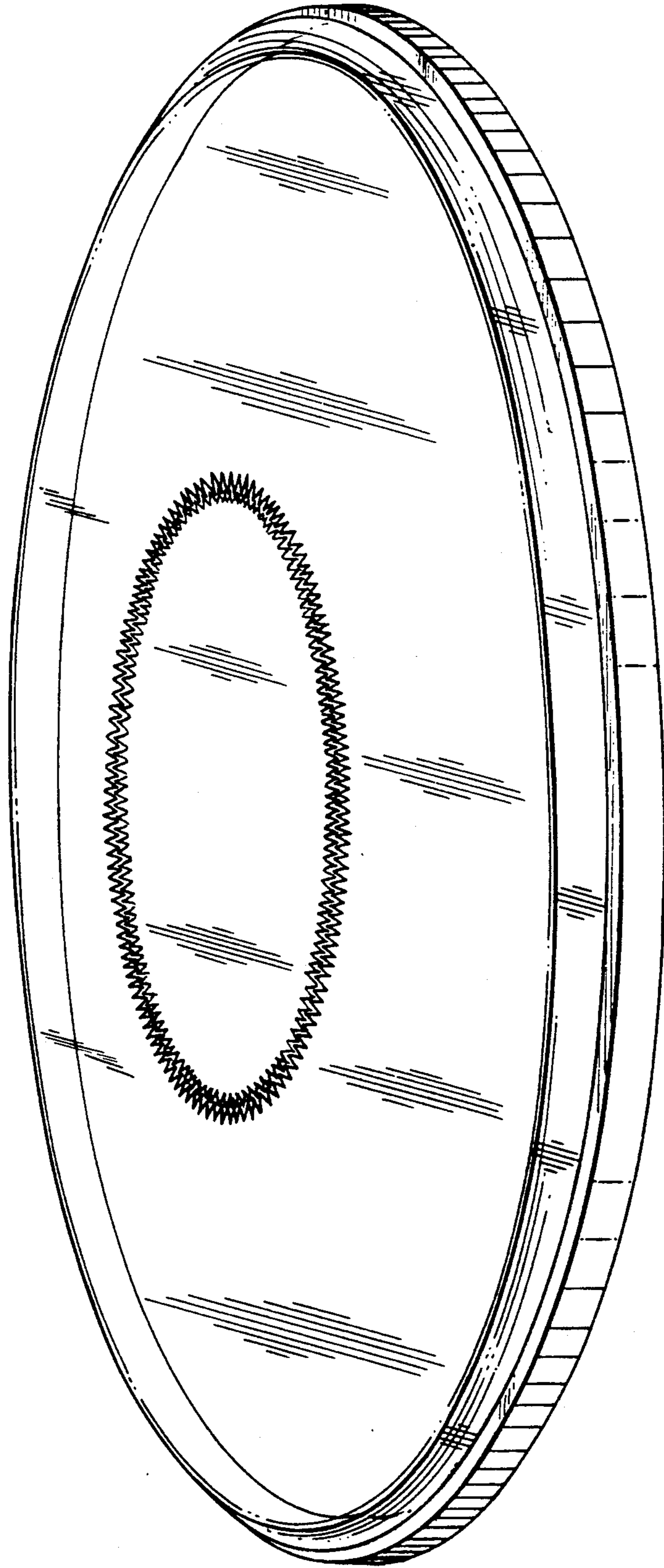

FIG. 2

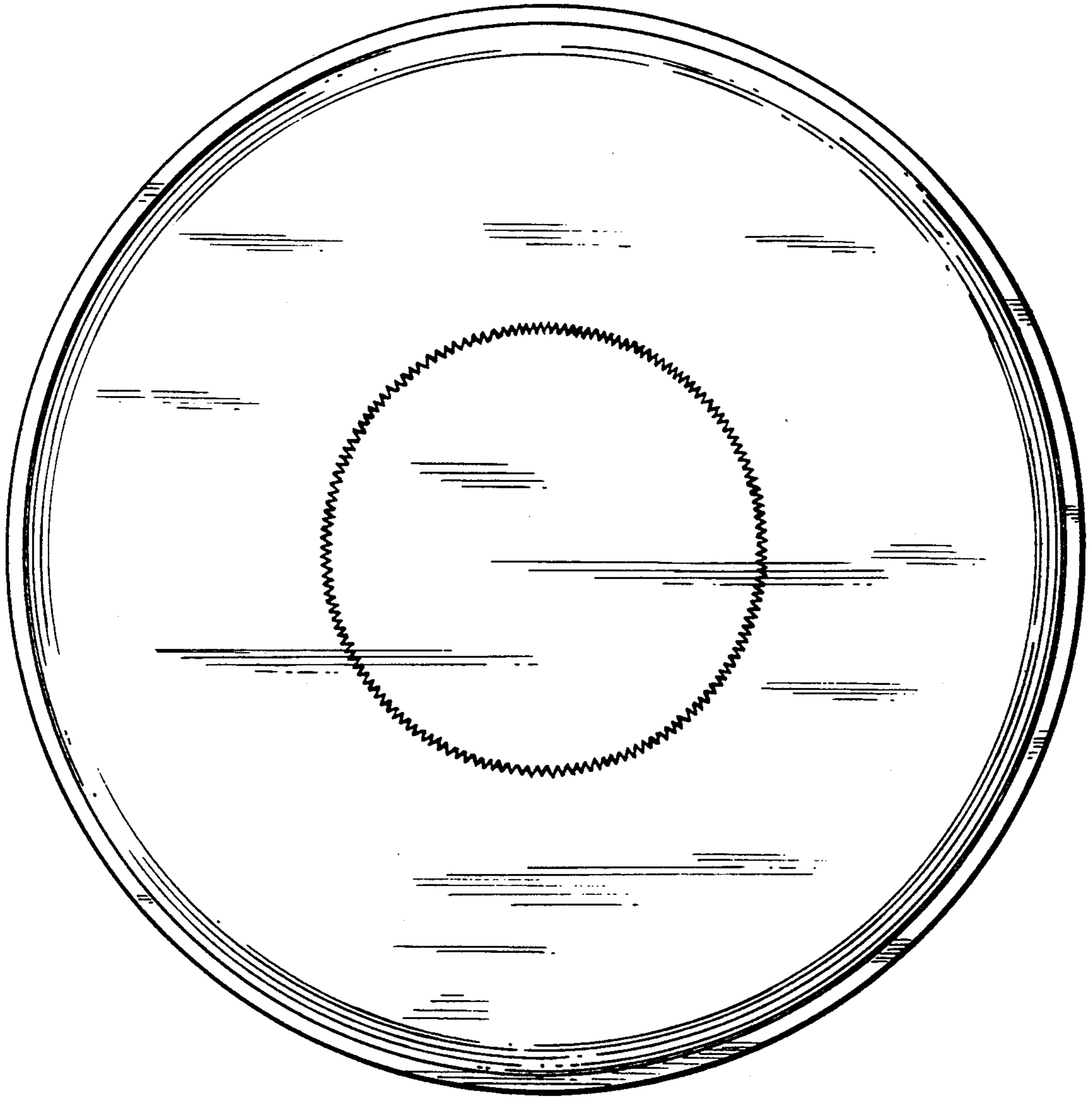

FIG. 3

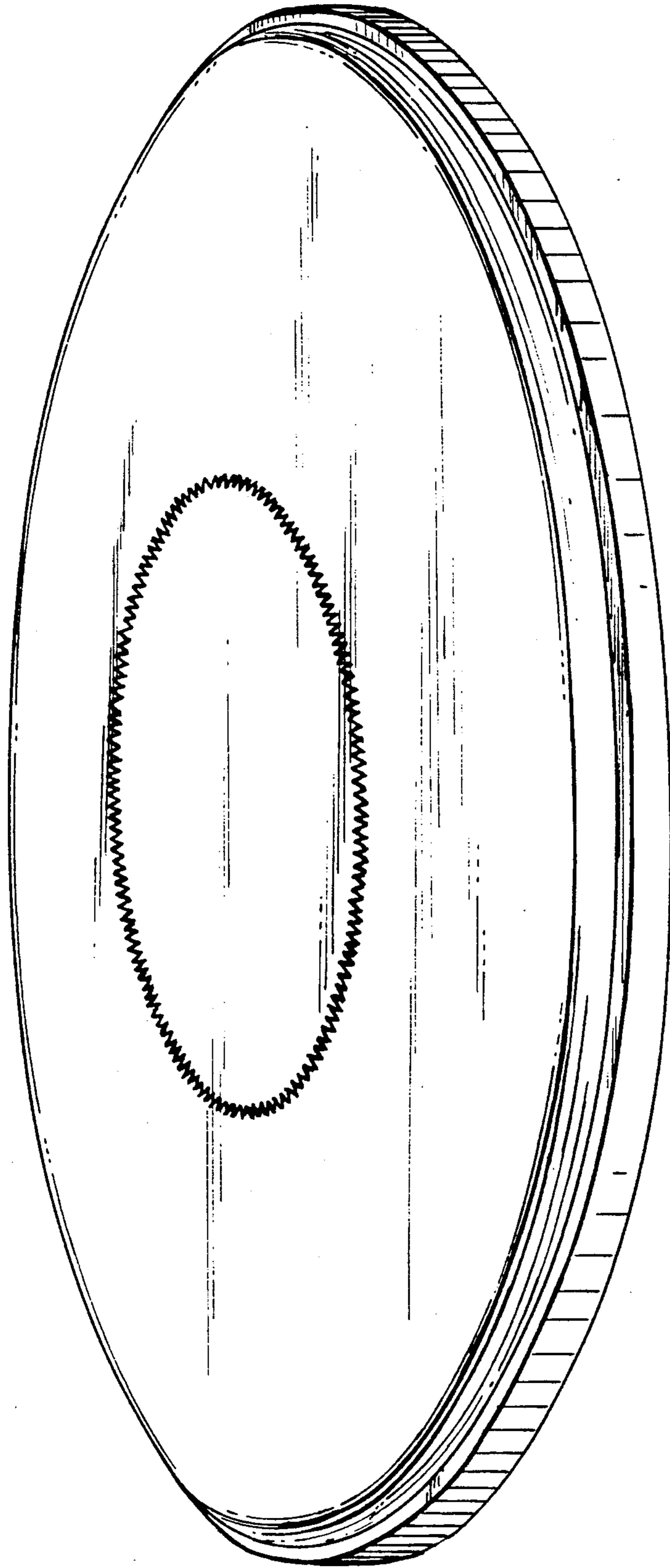

FIG. 4

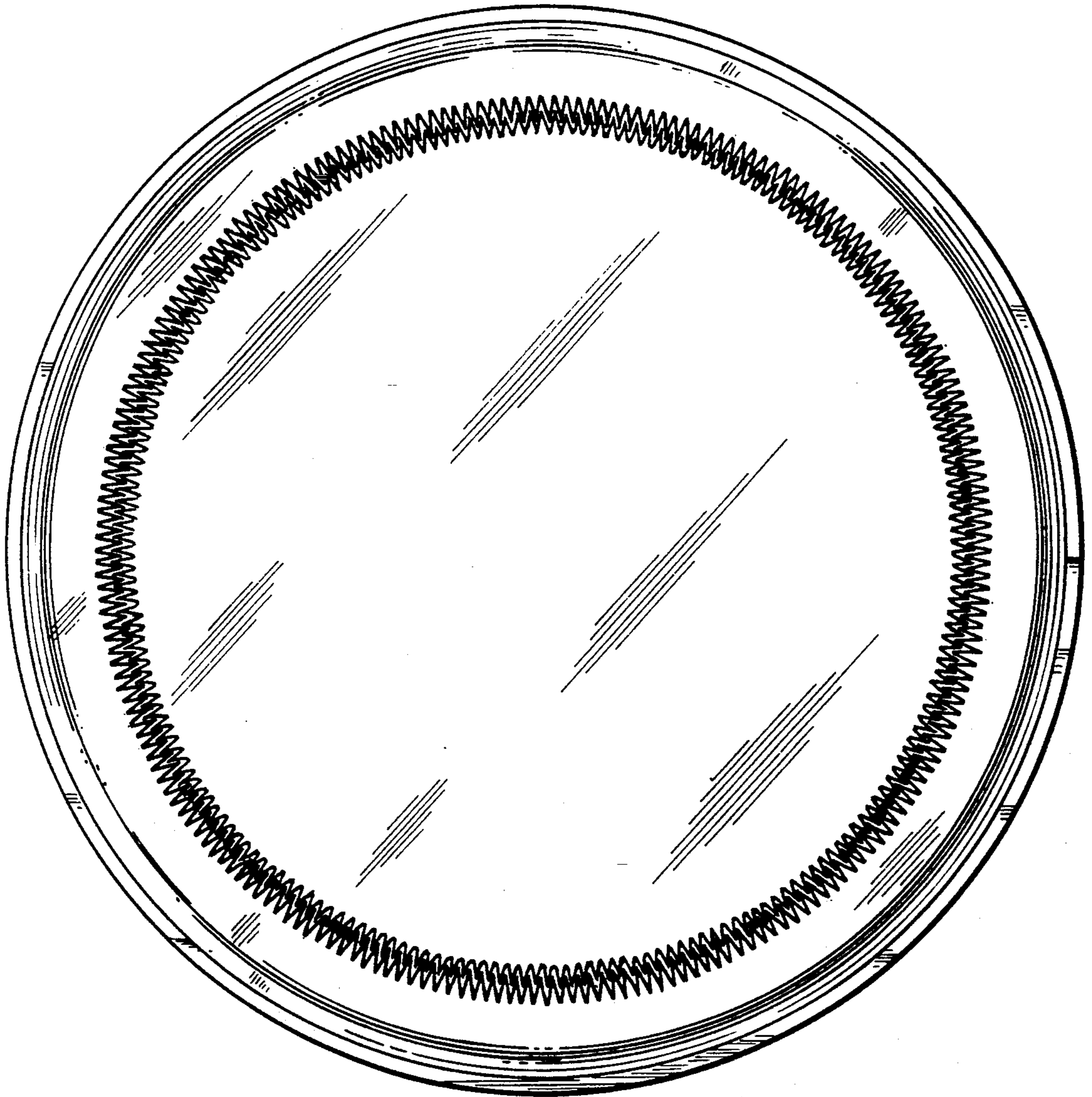

FIG. 5

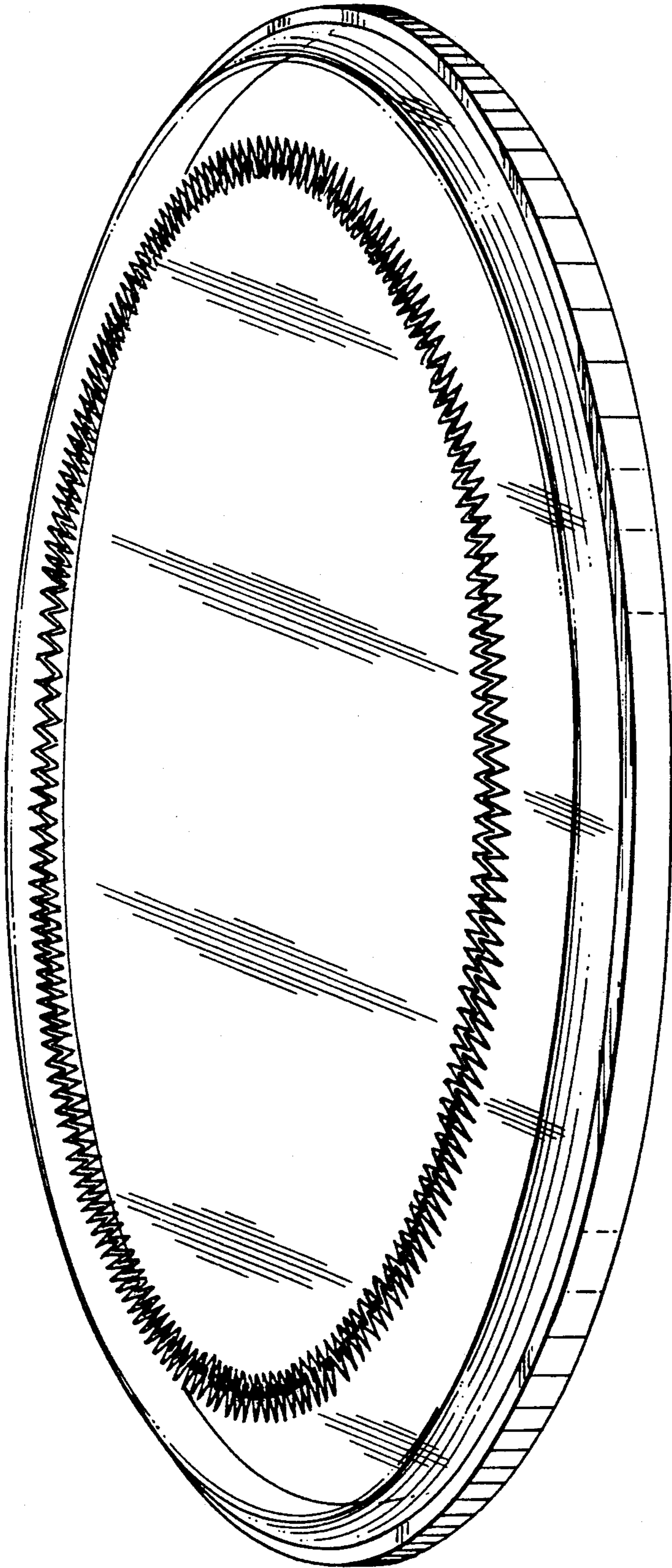

FIG. 6

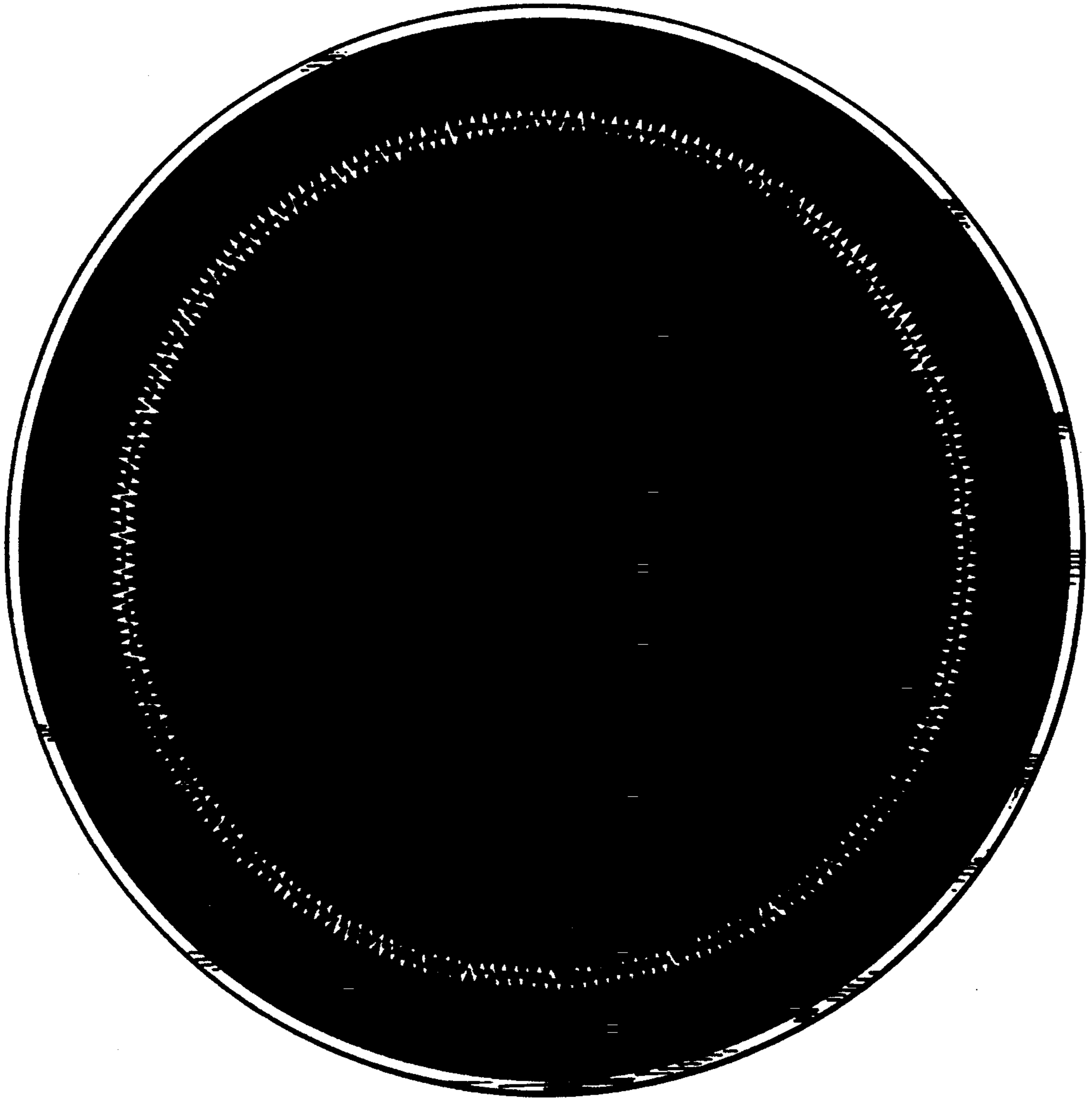

FIG. 7

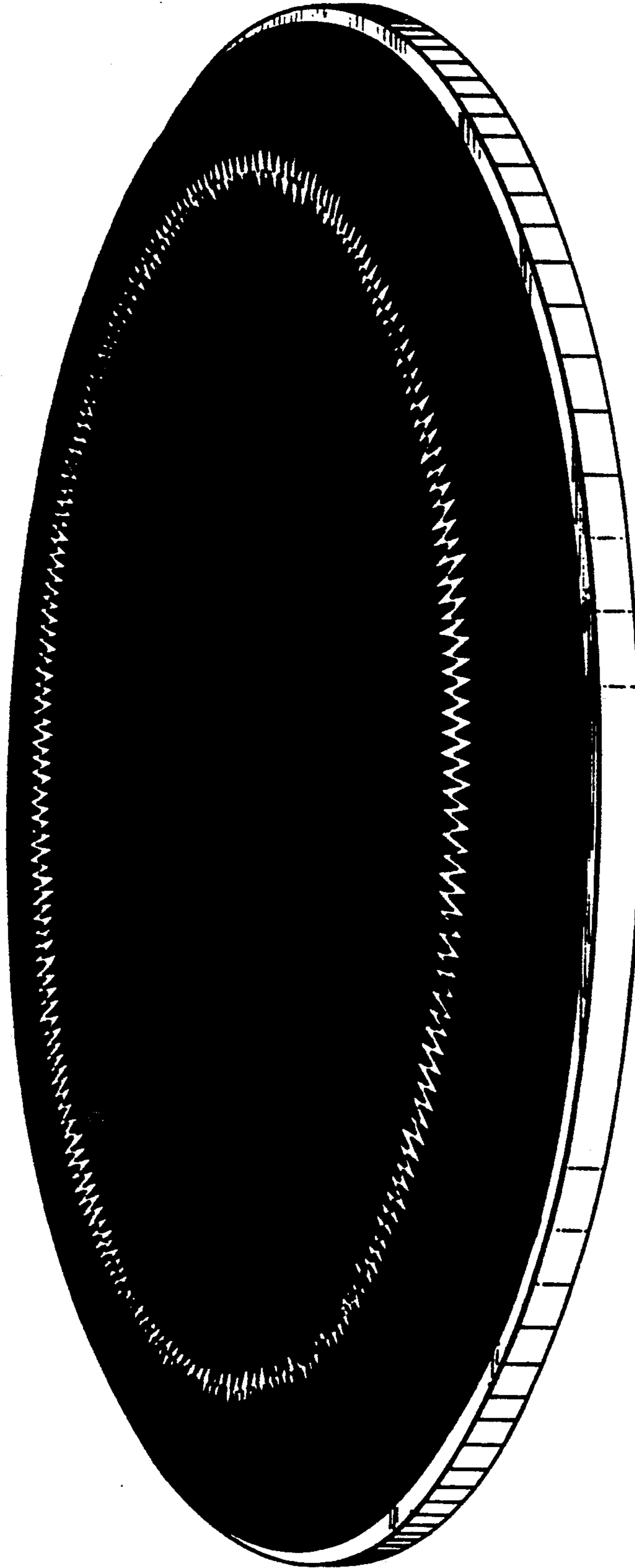

FIG. 8

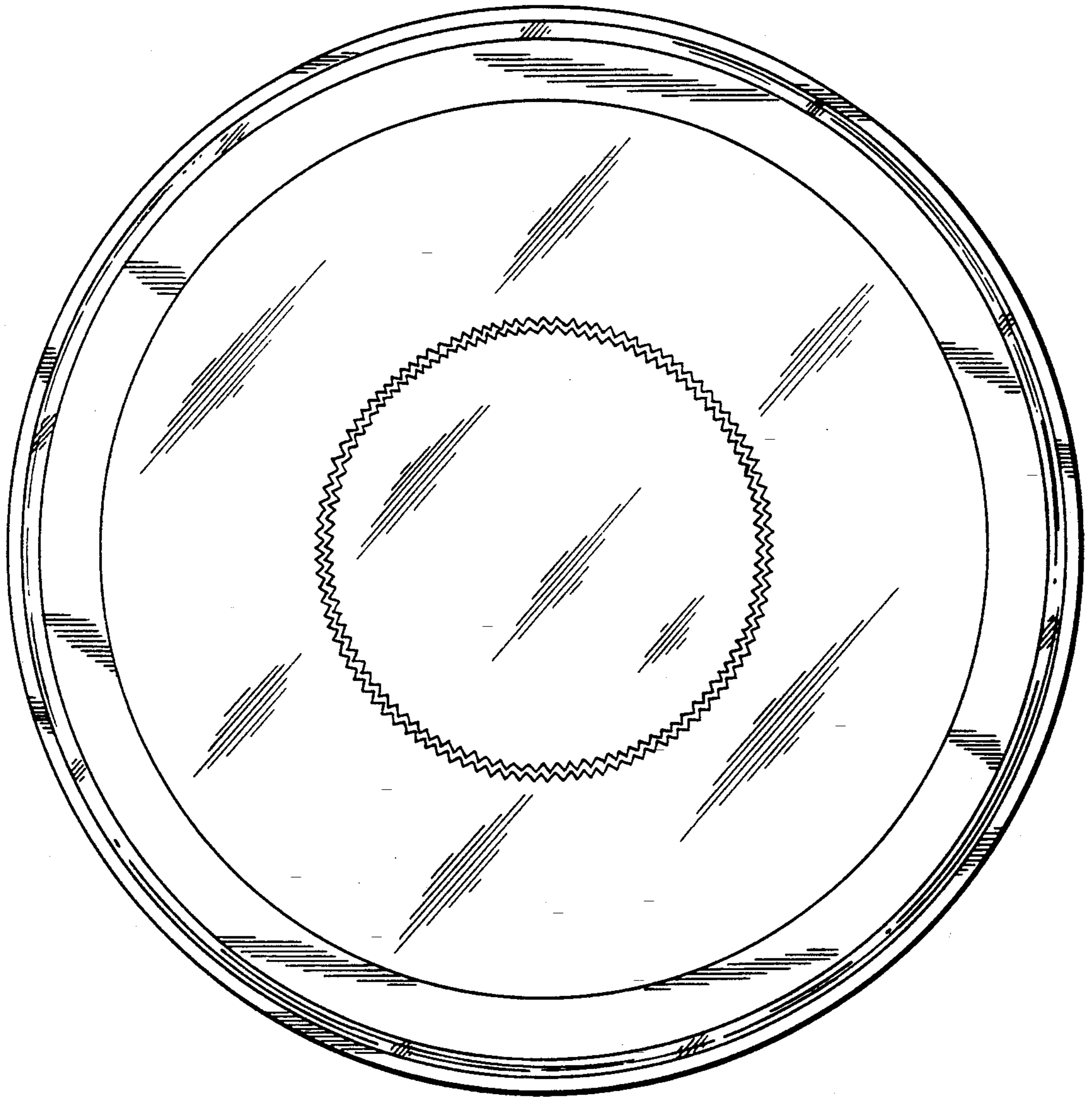

FIG. 9

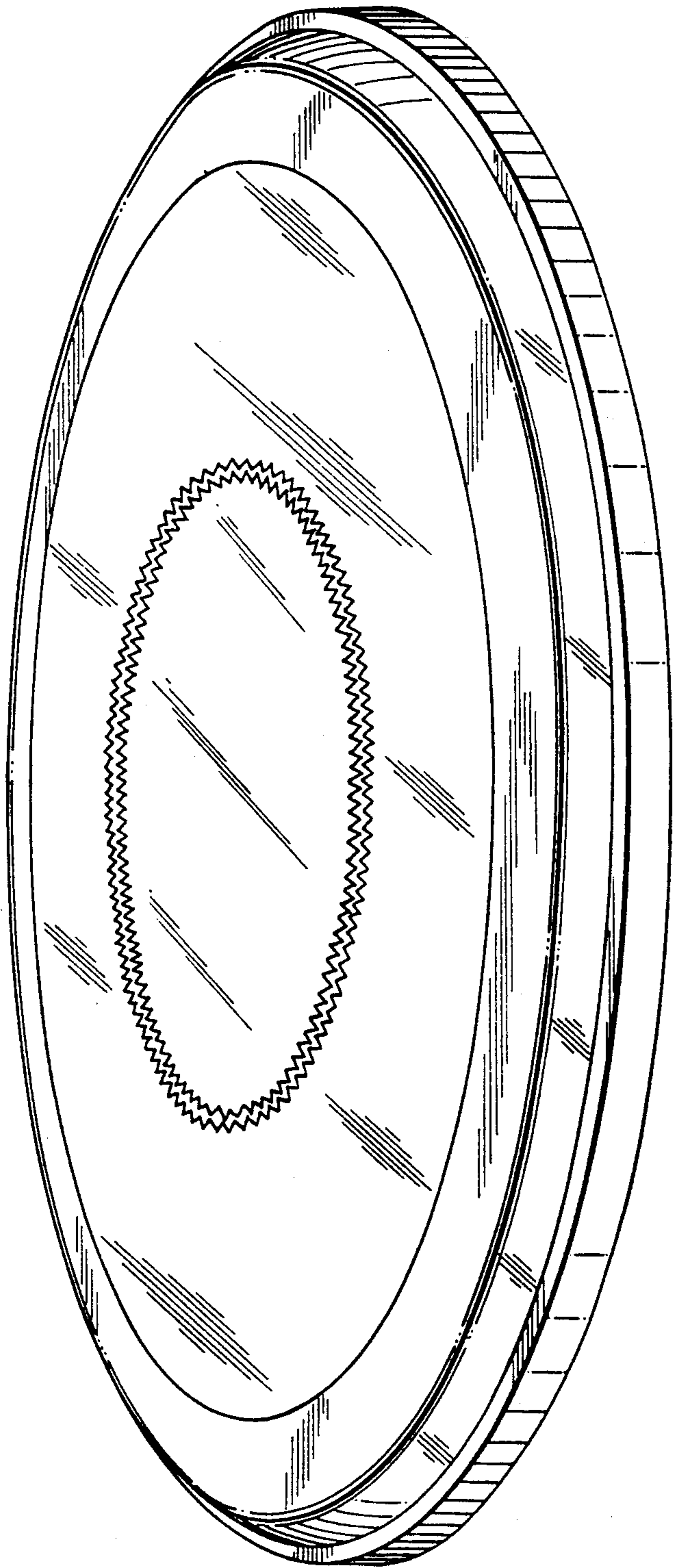

FIG. 10



FIG. 11