



US00D330037S

United States Patent [19]

[11] Patent Number: **Des. 330,037**

Wakayama et al.

[45] Date of Patent: **** Oct. 6, 1992**

[54] FOLDING BINOCULARS

[75] Inventors: **Shouji Wakayama; Akio Akiyama,**
both of Tokyo, Japan

[73] Assignee: **Young Optical Co., Ltd., Tokyo,**
Japan

[**] Term: **14 Years**

[21] Appl. No.: **445,343**

[22] Filed: **Dec. 4, 1989**

[52] U.S. Cl. **D16/133**

[58] Field of Search **D16/133; 350/545, 546,**
350/140, 145, 146, 250, 551, 552, 555

[56] References Cited

U.S. PATENT DOCUMENTS

91,969	6/1869	Saxton	350/546
D. 305,902	2/1990	Wakayama et al.	D16/133
D. 310,675	9/1990	Lu Huan	D16/133
D. 311,013	10/1990	Wakayama et al.	D16/133
567,890	9/1896	Densmore et al.	350/546
1,024,730	4/1912	Levy	350/546
2,002,782	5/1935	Lester	350/546
2,334,483	11/1943	Dennis	350/140
3,005,378	10/1961	Golden	350/140

FOREIGN PATENT DOCUMENTS

372907	4/1923	Fed. Rep. of Germany	350/546
423739	4/1911	France	350/546
9889	of 1904	United Kingdom	350/546

Primary Examiner—A. Hugo Word
Assistant Examiner—Doris V. Coles
Attorney, Agent, or Firm—Felfe & Lynch

[57] CLAIM

The ornamental design for folding binoculars, as shown and described.

DESCRIPTION

FIG. 1 is a front elevational view of folding binoculars in the folded position, showing our new design; FIG. 2 is a rear elevational view thereof; FIG. 3 is a top plan view thereof; FIG. 4 is a bottom plan view thereof; FIG. 5 is a left side elevational view thereof; FIG. 6 is a right side elevational view thereof; FIG. 7 is a top view in the open position; FIG. 8 is a bottom plan view thereof; FIG. 9 is a front elevational view thereof; FIG. 10 is a rear elevational view thereof; FIG. 11 is a left side elevational view thereof; FIG. 12 is a right side elevational view thereof; and, FIG. 13 is a perspective view in the open position.

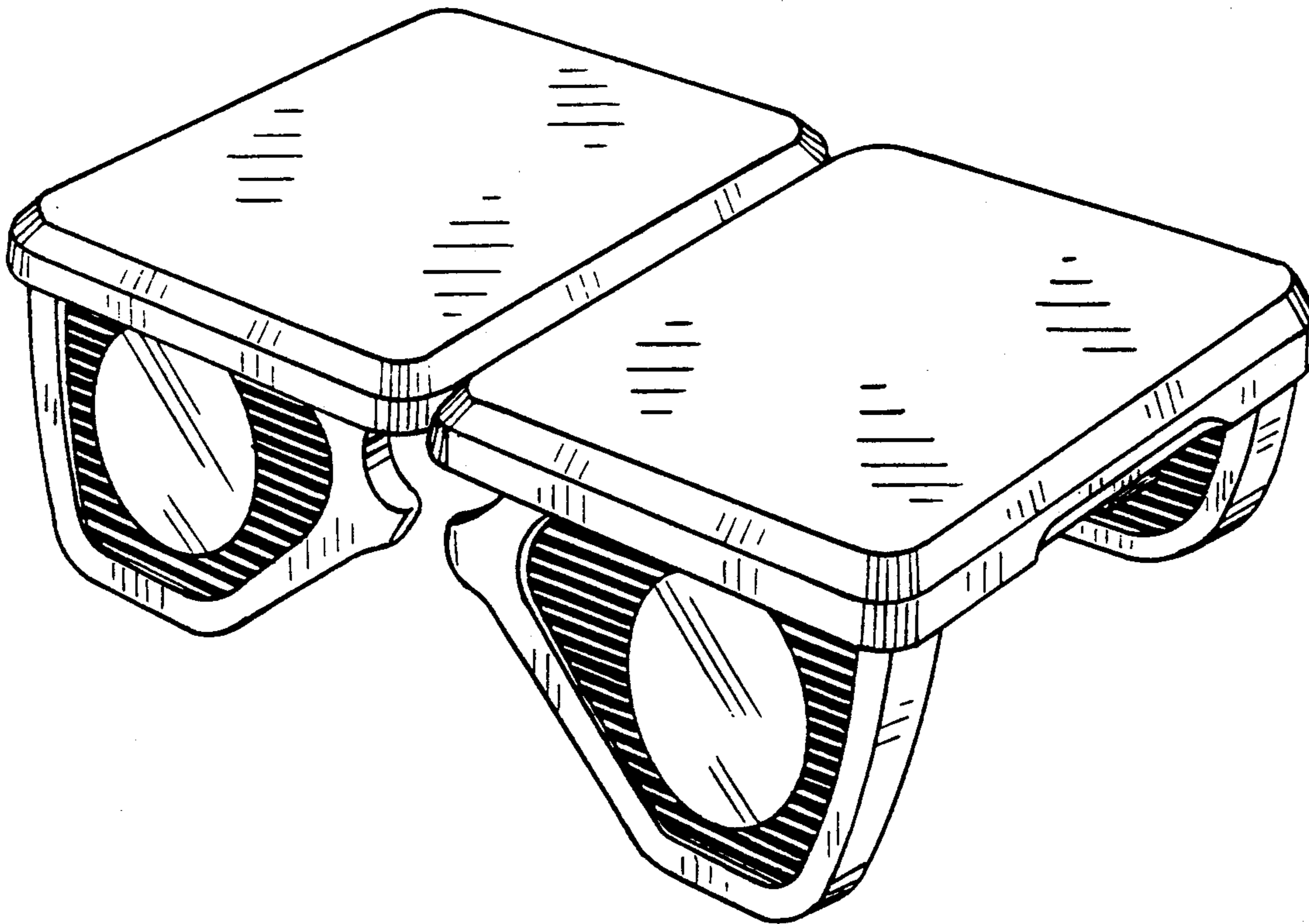

FIG. 1

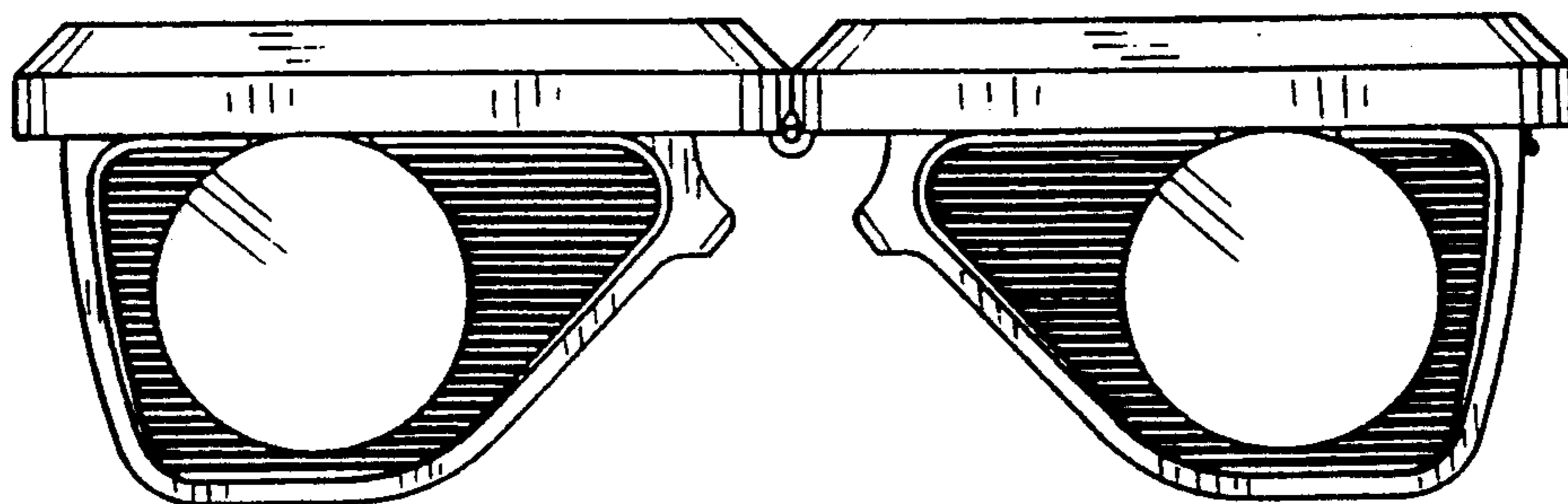

FIG. 3

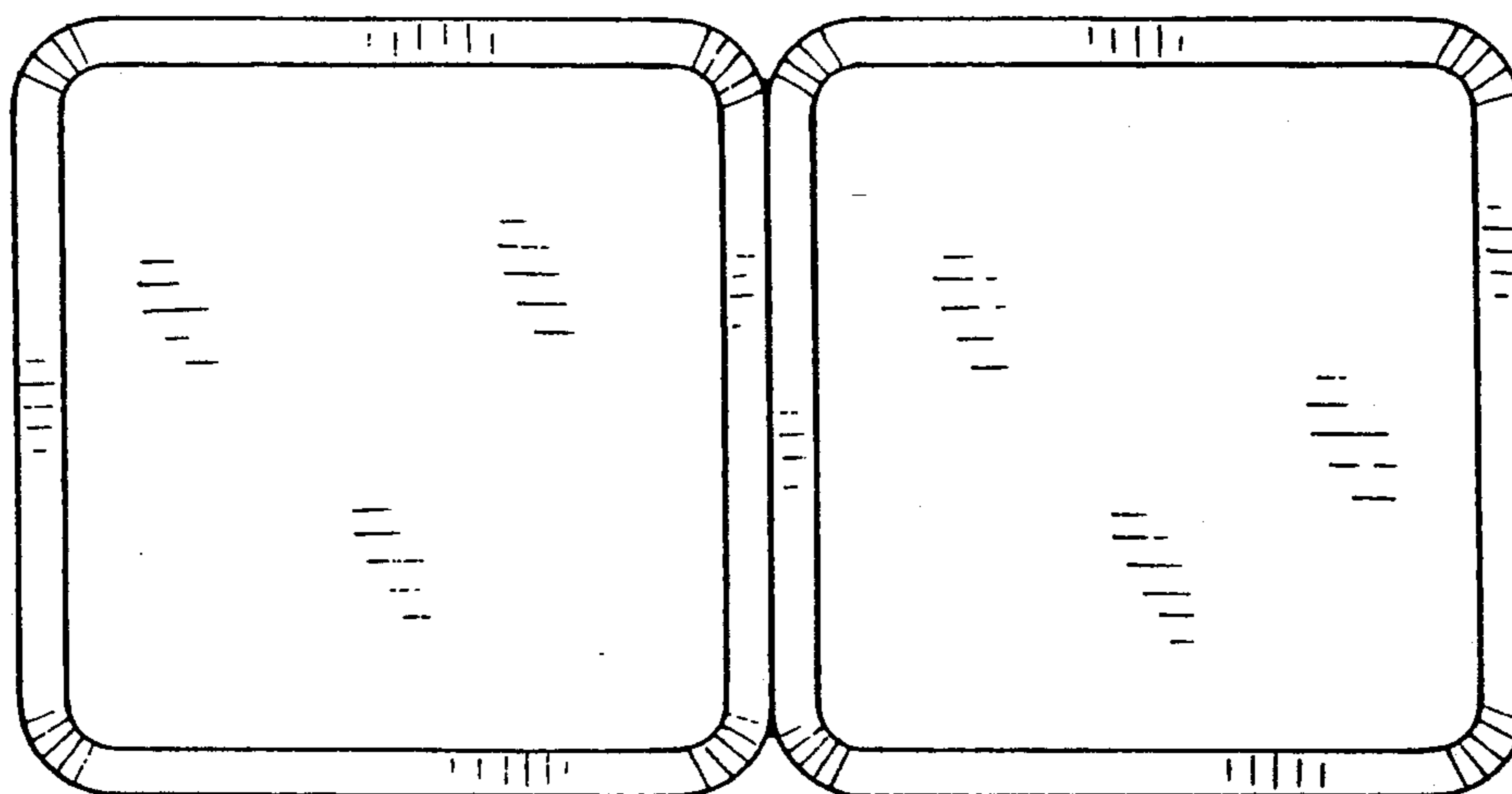

FIG. 5

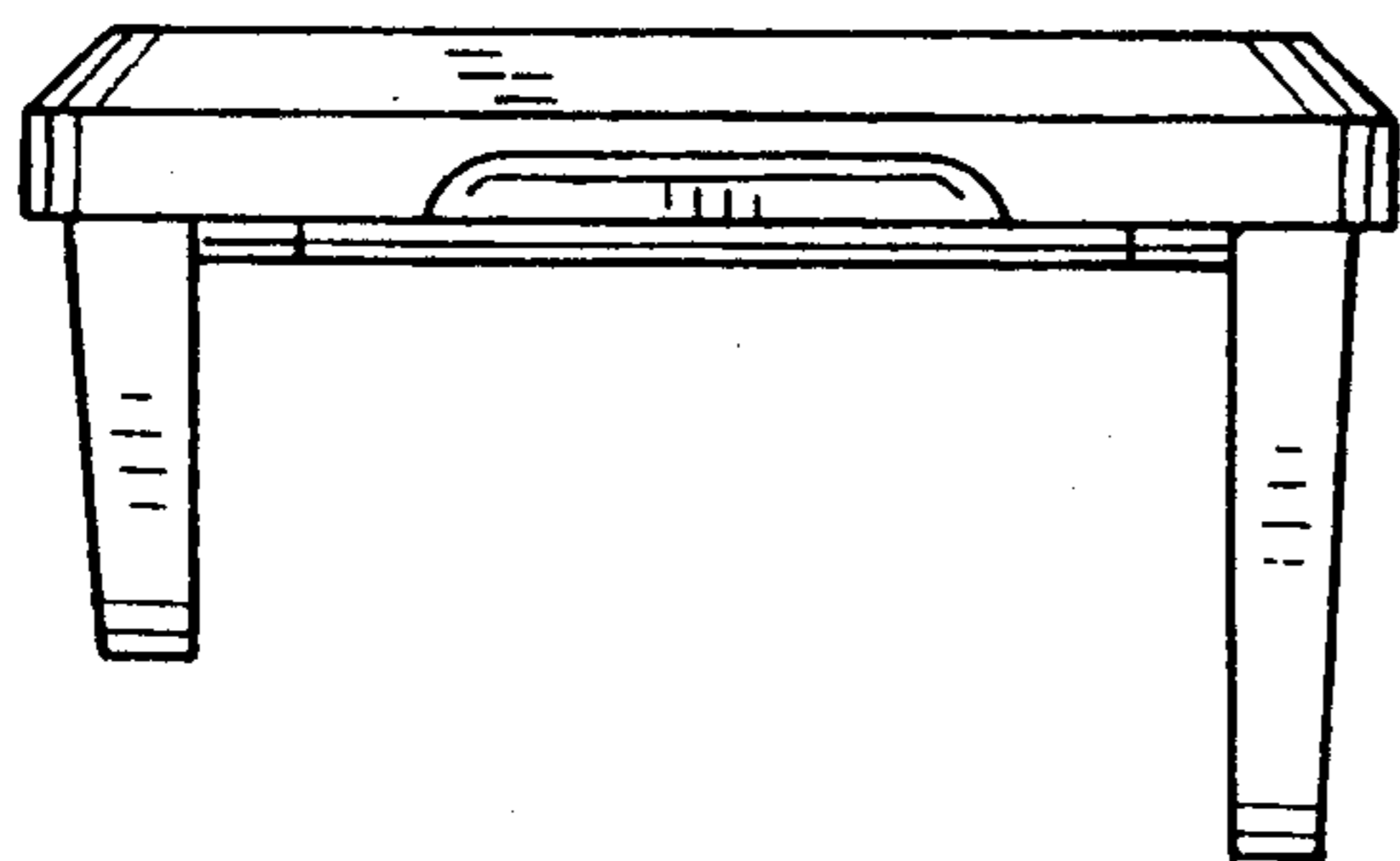

FIG. 6

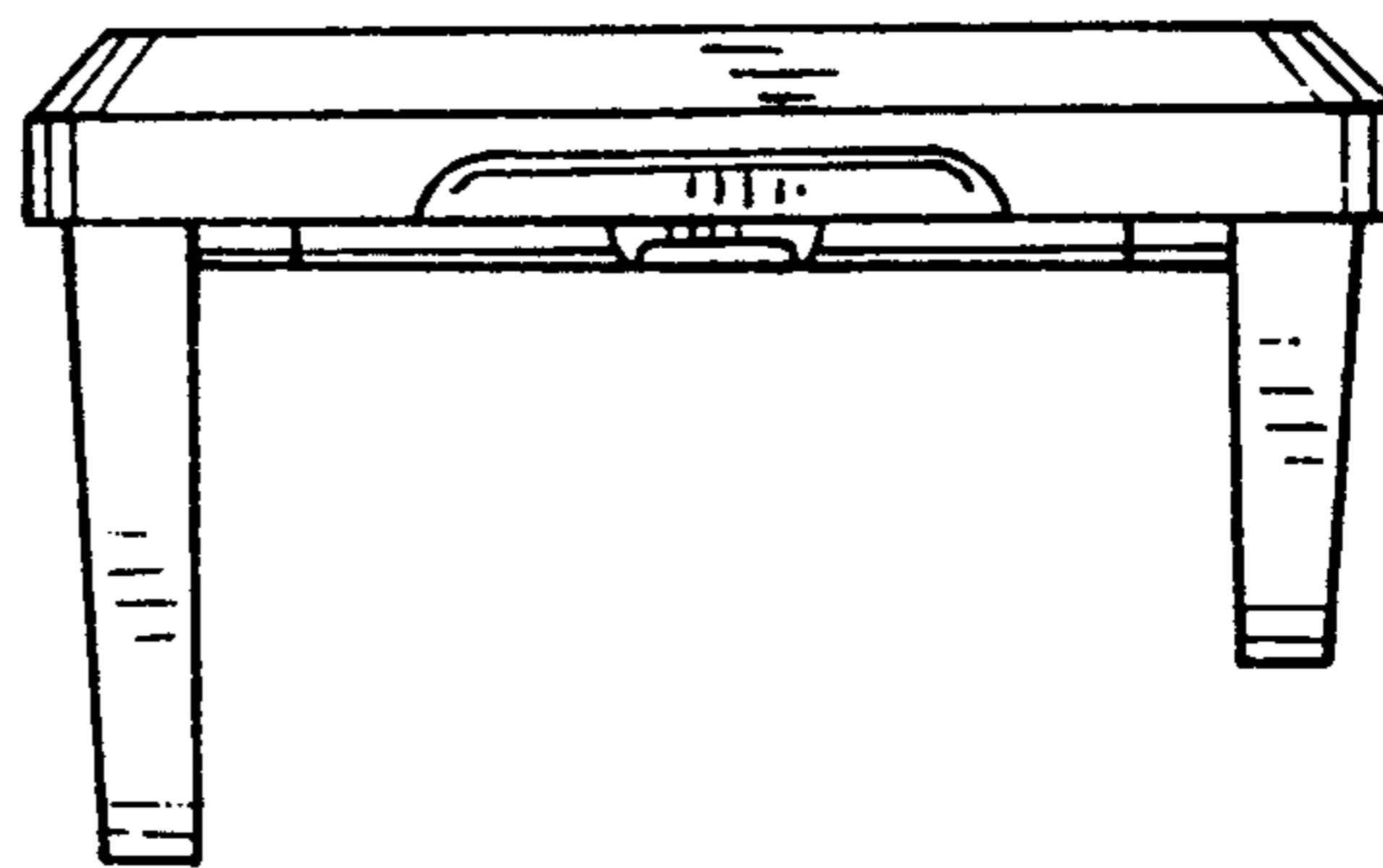

FIG. 2

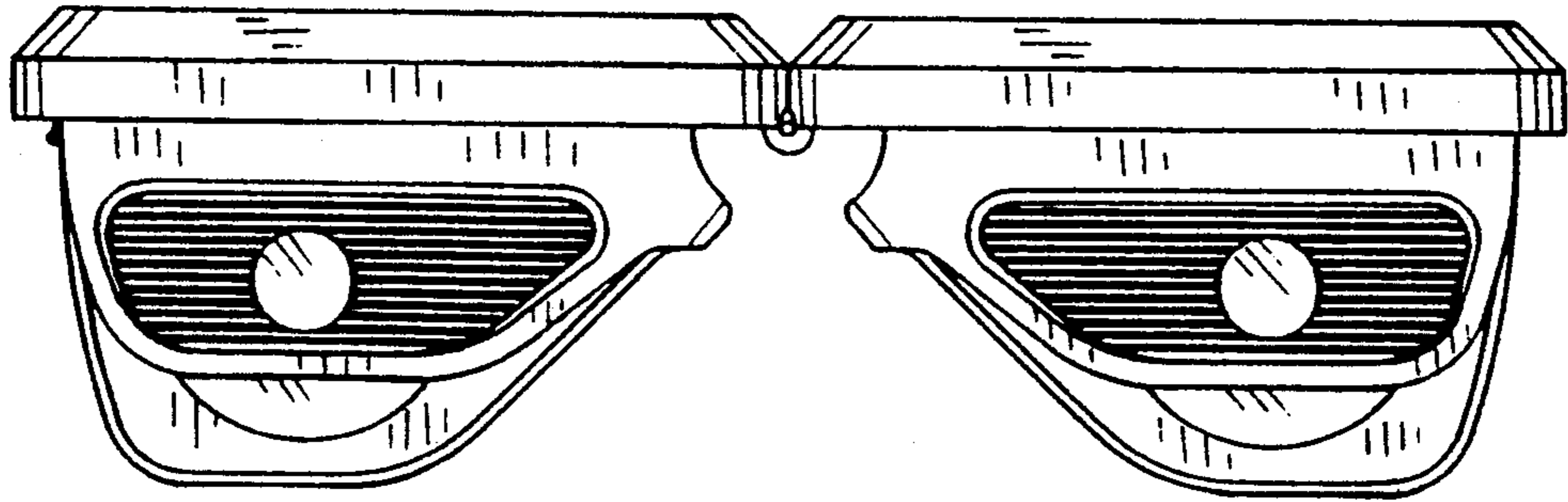

FIG. 4

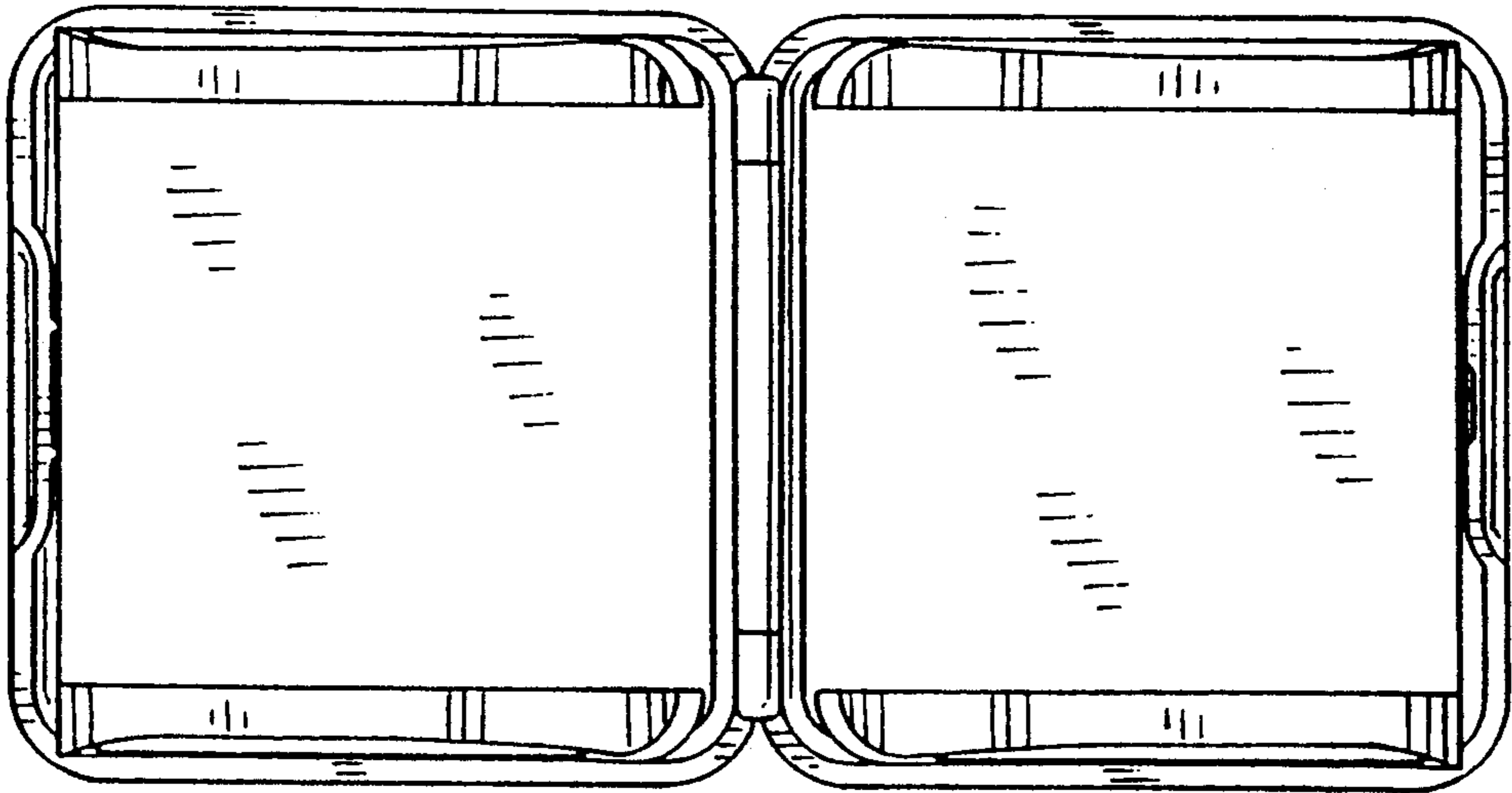

FIG. 7

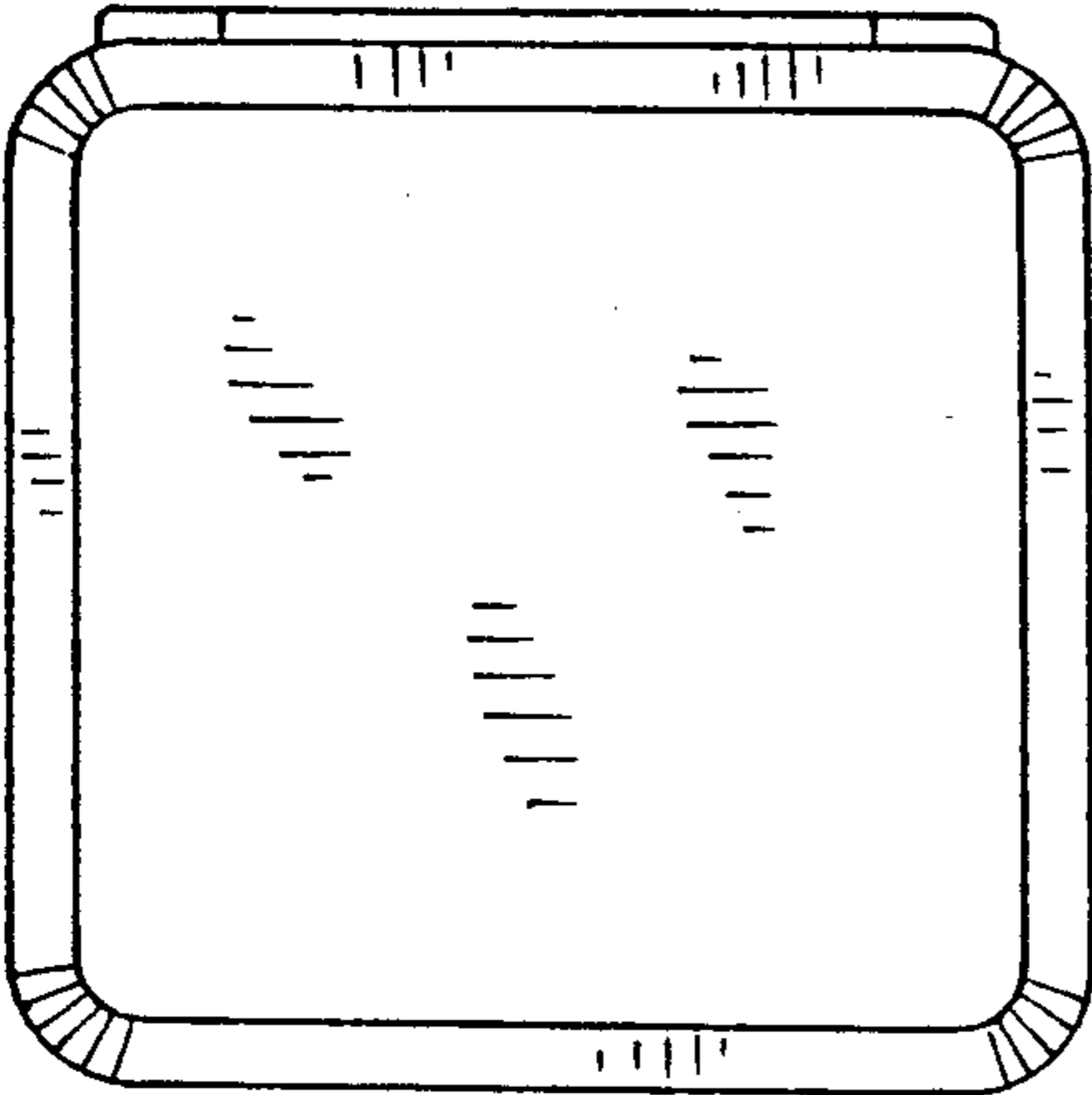

FIG. 8

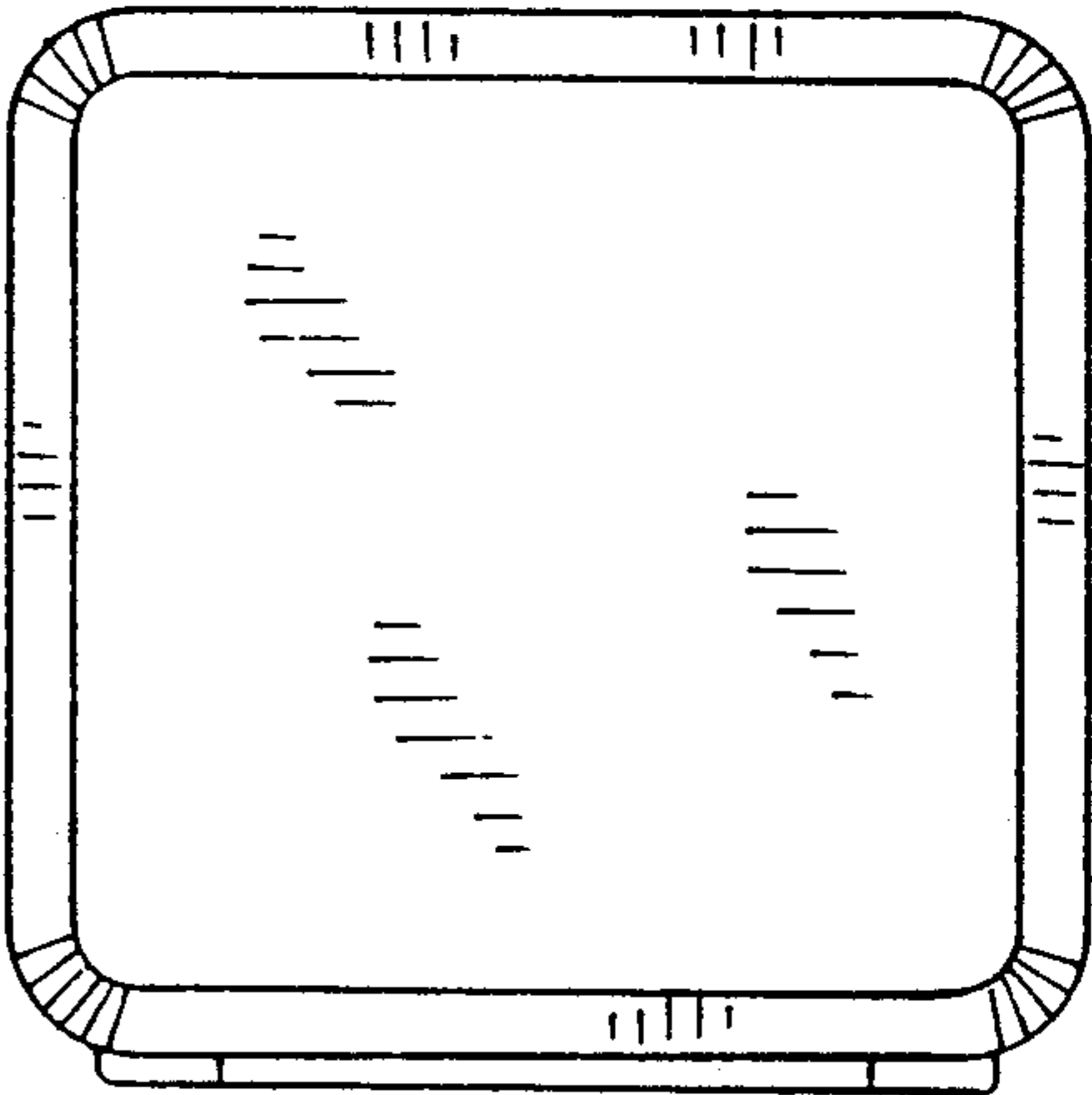

FIG. 9

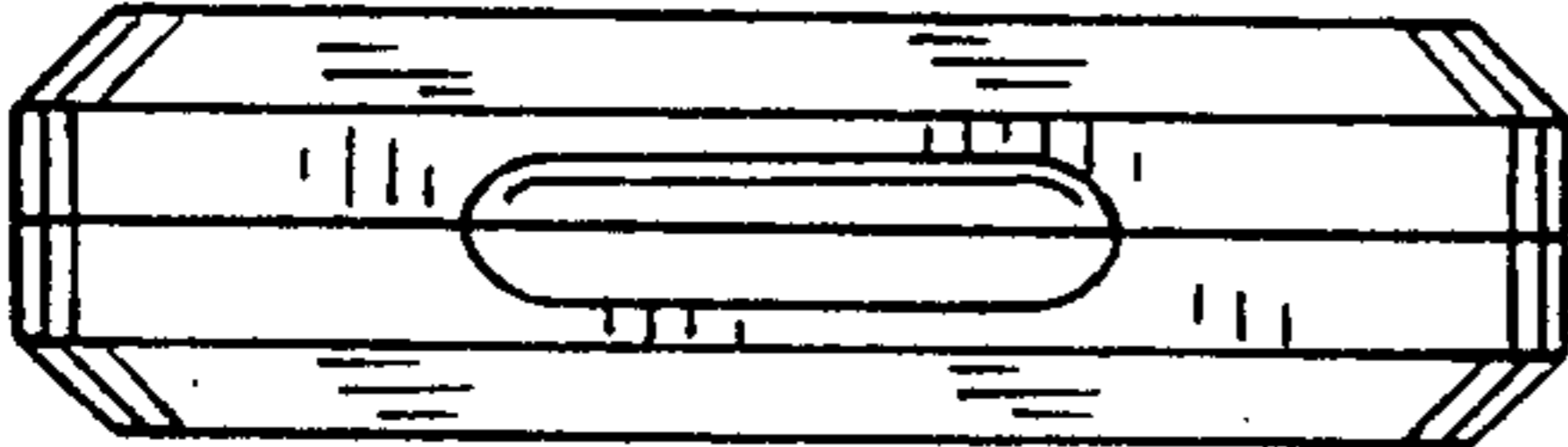

FIG. 10

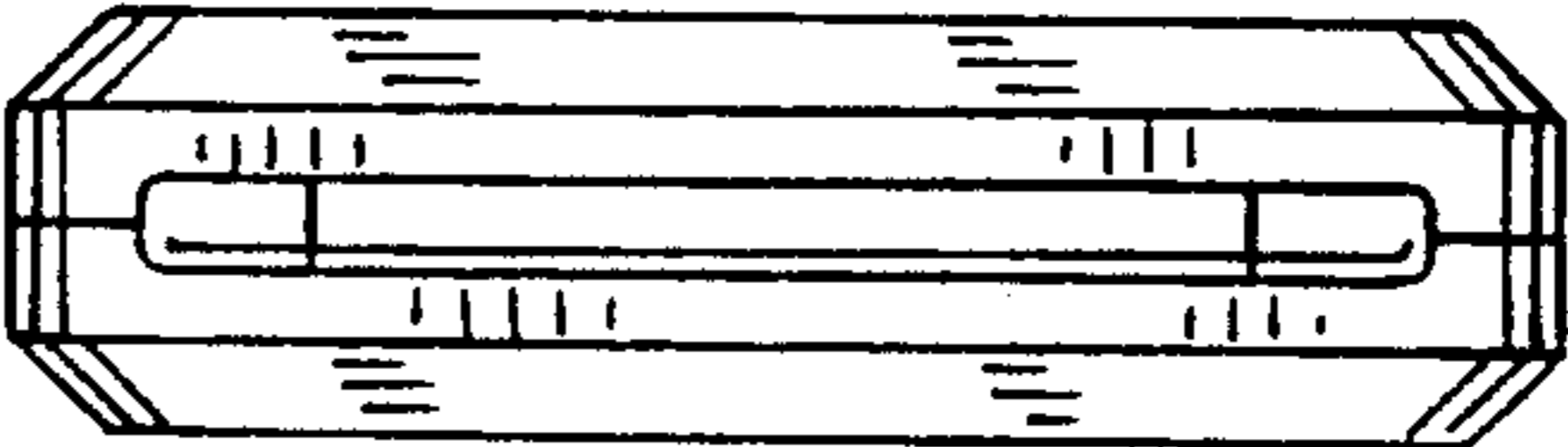

FIG. 11

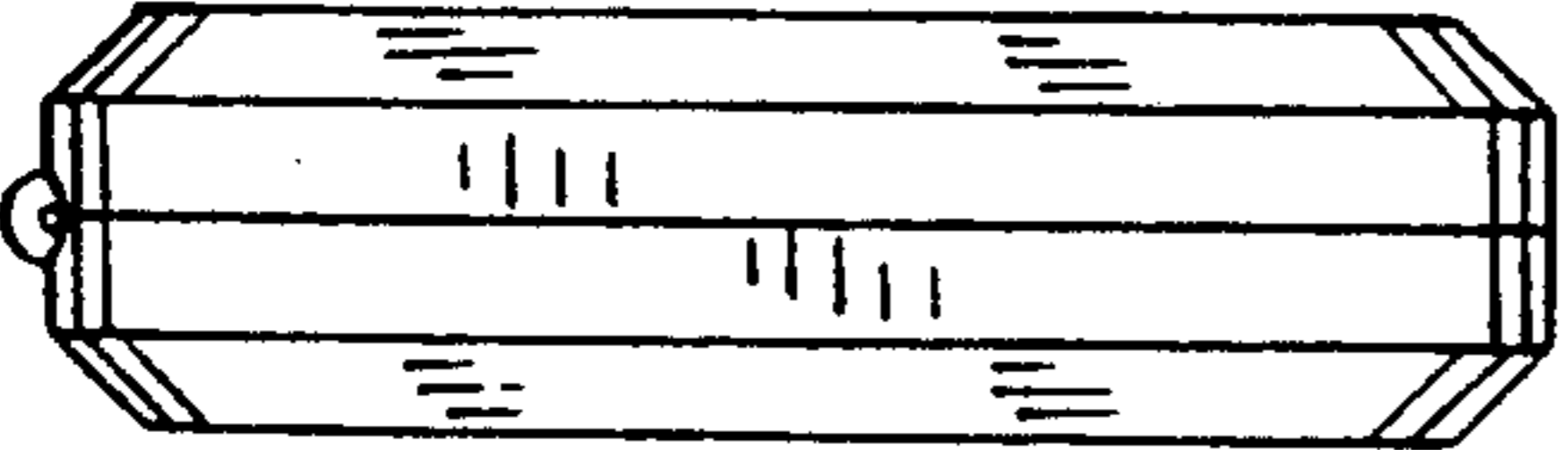
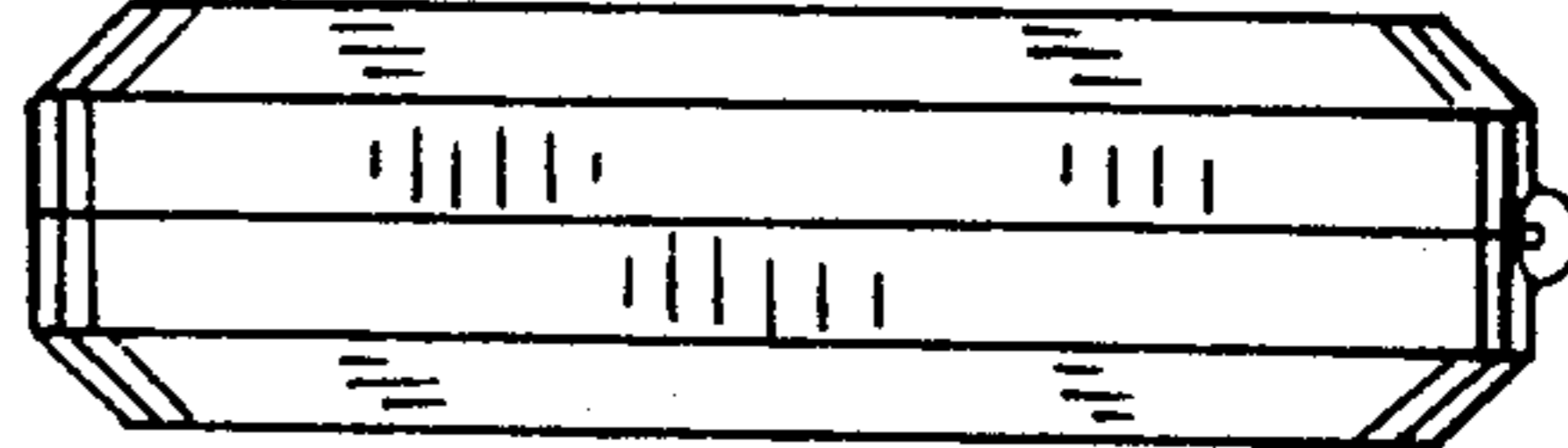

FIG. 12



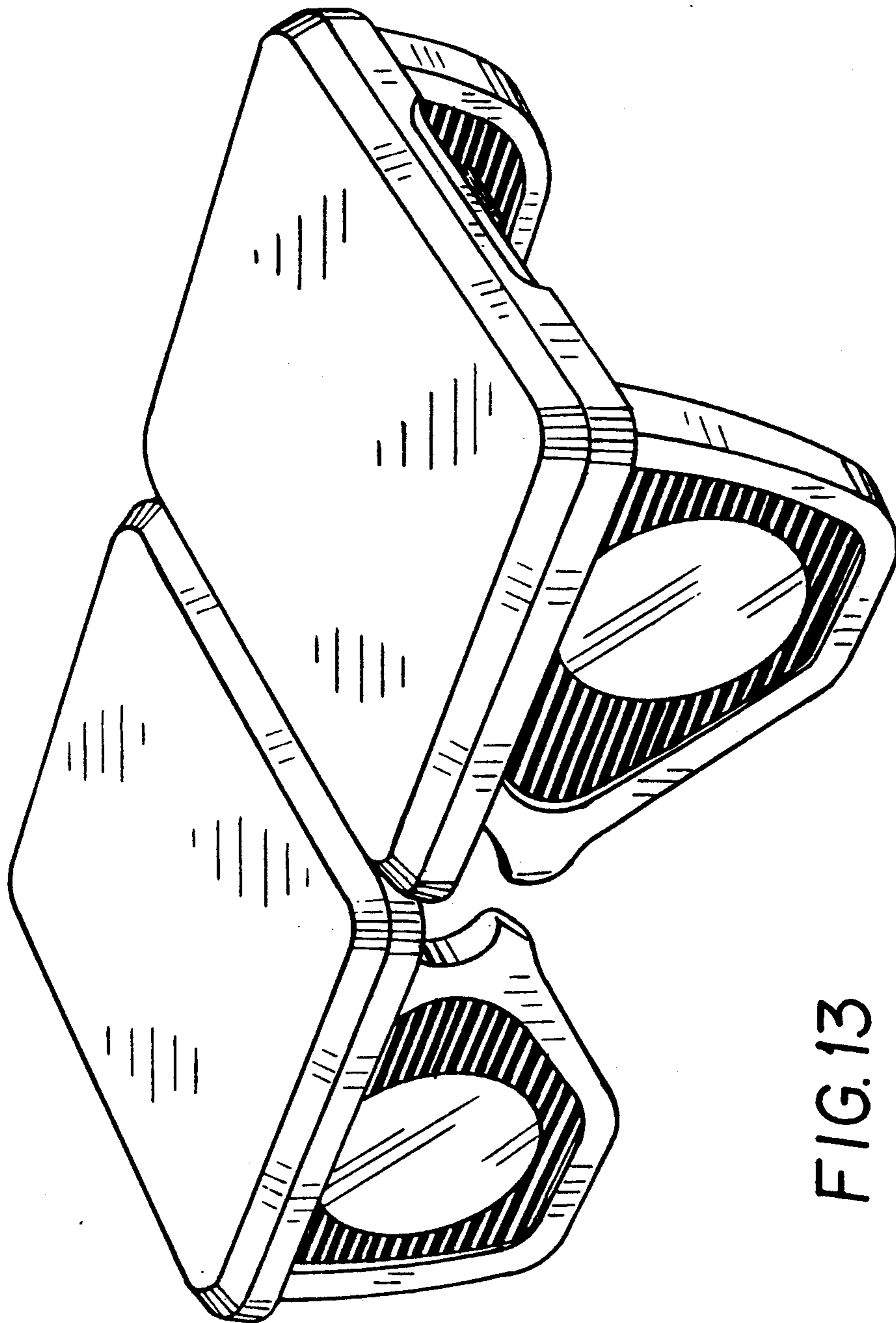

FIG. 13