



US00D329994S

United States Patent [19]

[11] Patent Number: **Des. 329,994**

Webster

[45] Date of Patent: **** Oct. 6, 1992**

[54] ANTI-SMOKING NOVELTY

1,992,294	2/1935	Eyclebhymer	43/82
4,360,986	11/1982	Dushey	43/82
4,517,557	5/1985	Agron et al.	43/82 X

[76] Inventor: **Christopher A. Webster**, 2230 George Marshall Dr., Apt. 215, Falls Church, Va. 22043

Primary Examiner—Bernard Ansher
Assistant Examiner—Dominic Simone

[**] Term: **14 Years**

[57] **CLAIM**

[21] Appl. No.: **533,720**

The ornamental design for an anti-smoking novelty, as shown and described.

[22] Filed: **Jun. 6, 1990**

[52] U.S. Cl. **D11/157; D22/119**

DESCRIPTION

[58] Field of Search **D11/131, 157; D22/119; D27/102, 106; 43/82; D21/188**

FIG. 1 is a top front perspective view of an anti-smoking novelty showing my new design, the ash tray showing in broken lines forming no part of the claimed design;

[56] **References Cited**

U.S. PATENT DOCUMENTS

D. 175,531	9/1955	Brinton	D21/188 X
D. 262,275	12/1981	Pulise	D11/157
D. 281,059	10/1985	Lenine	D11/157
580,694	4/1897	Hooker et al.	43/82
1,722,857	7/1929	Ramsey et al.	43/82

FIG. 2 is a top plan view thereof;

FIG. 3 is a bottom plan view thereof;

FIG. 4 is a front elevational view thereof, the rear being a mirror image;

FIG. 5 is a right side elevational view thereof; and,

FIG. 6 is a left side elevational view thereof.

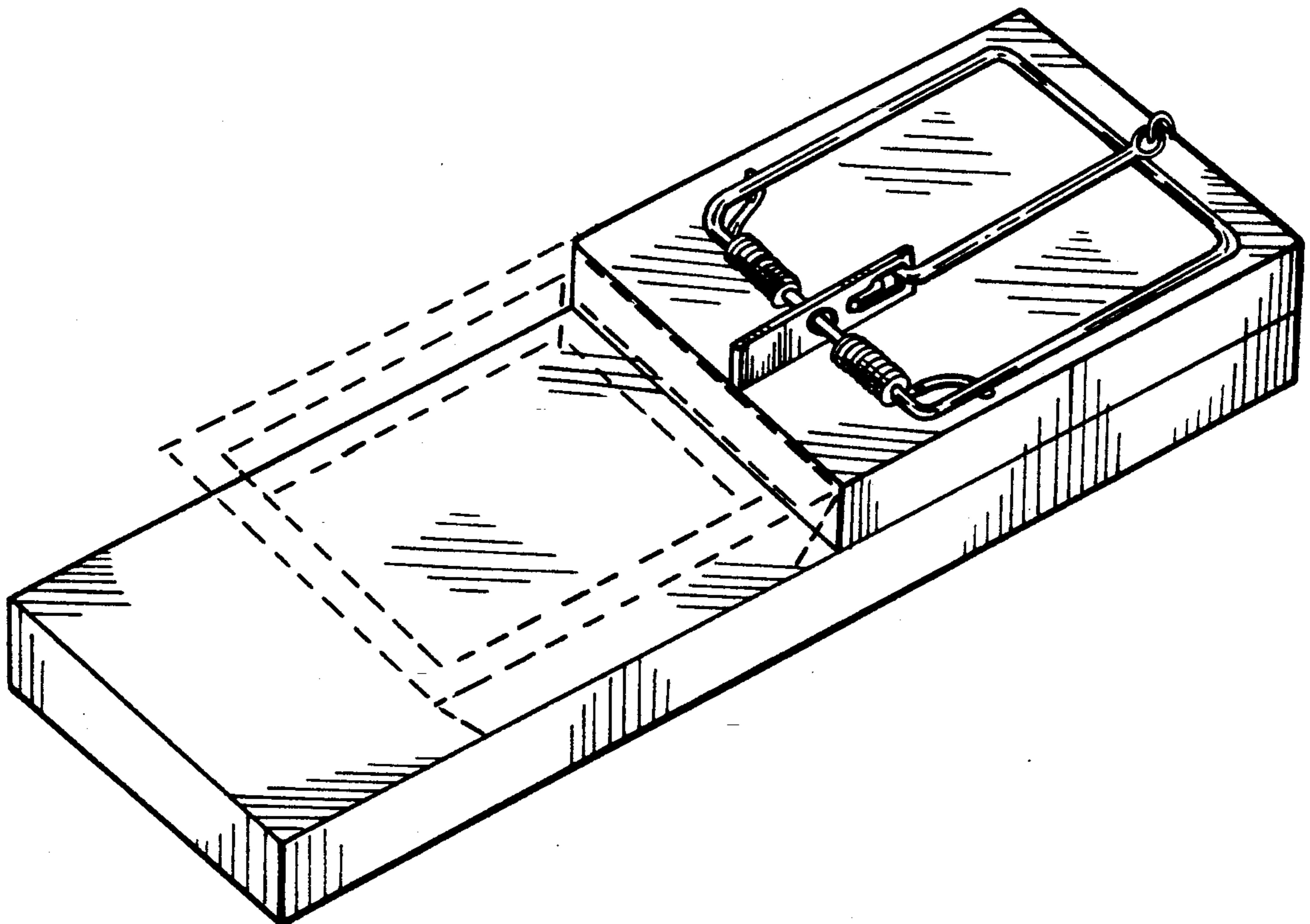

FIG. 1

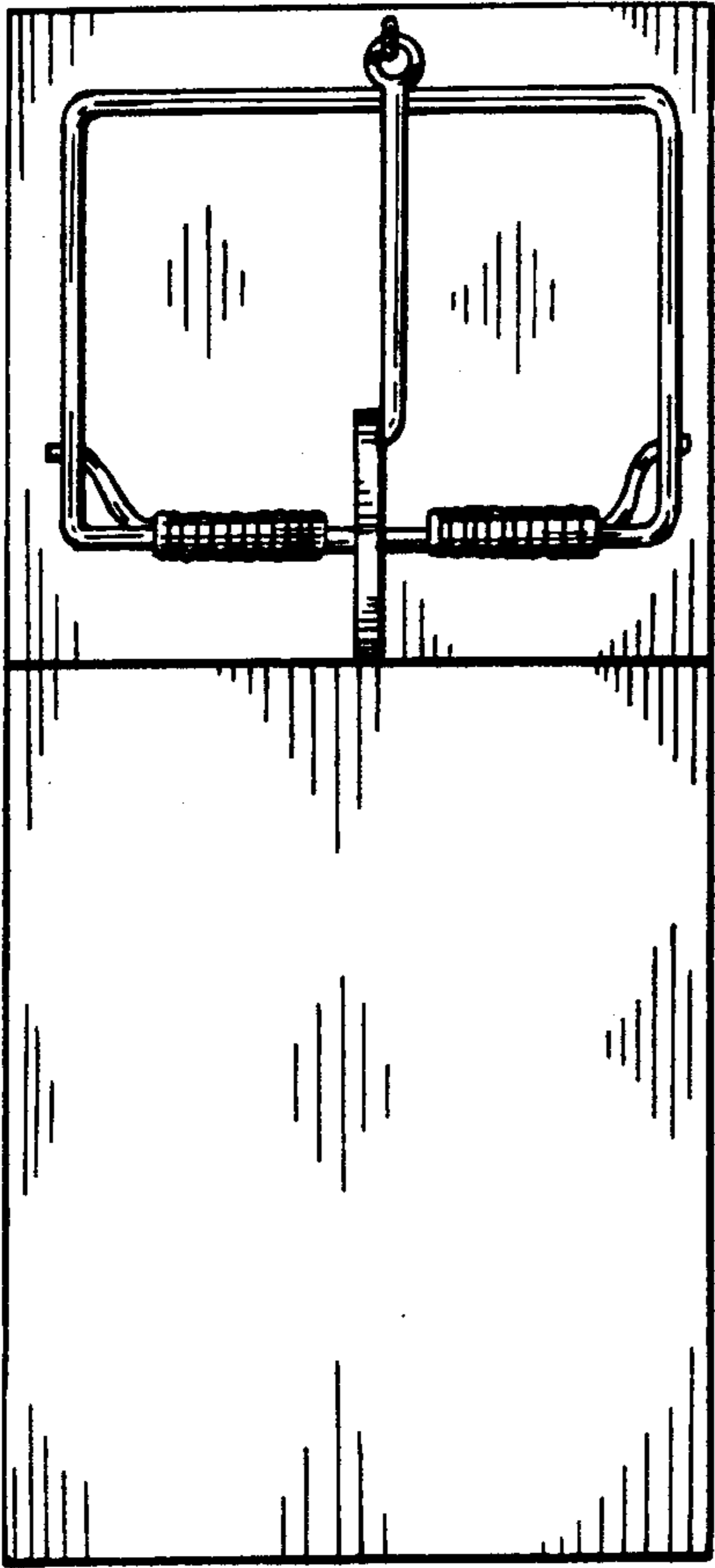
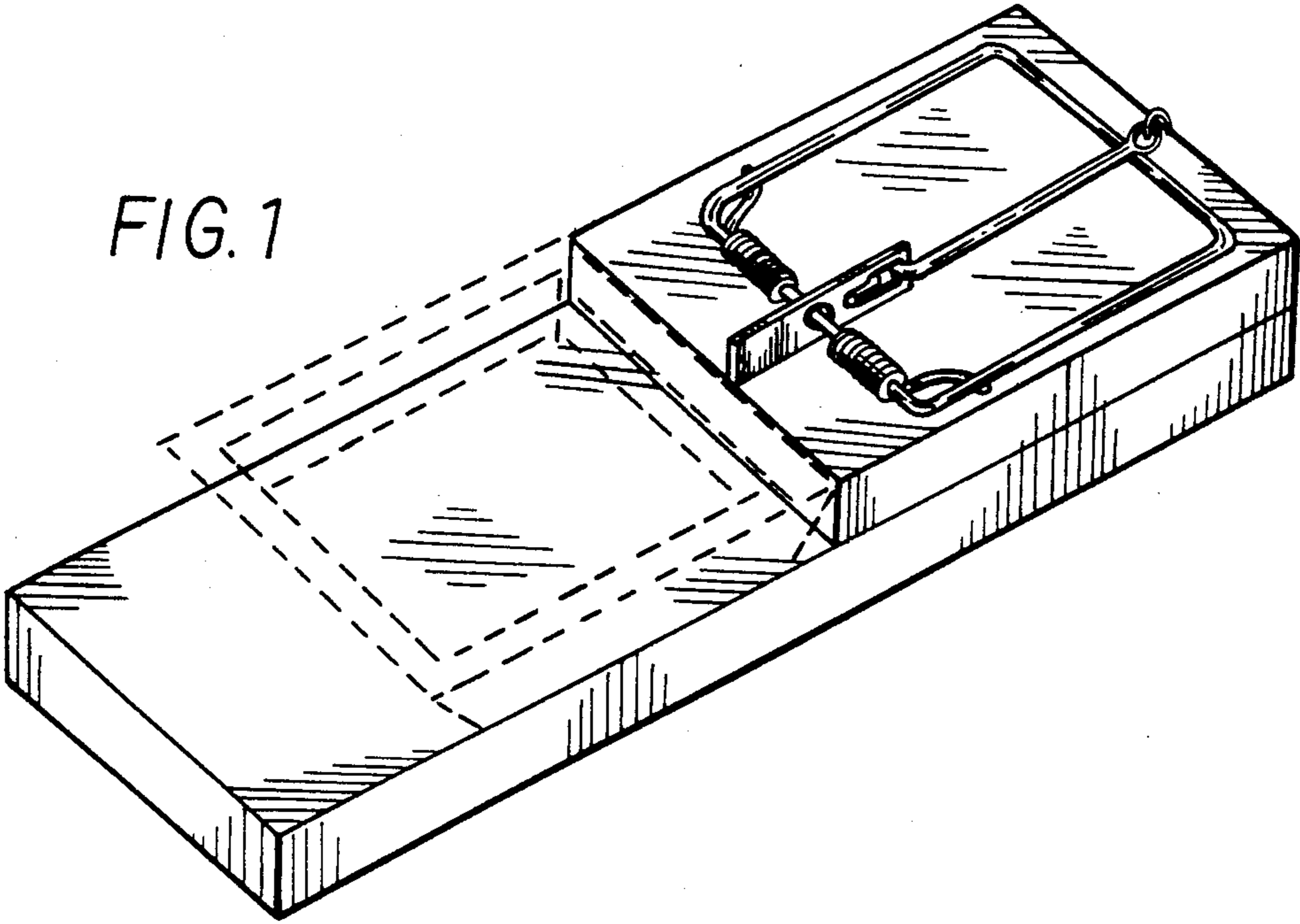

FIG. 2

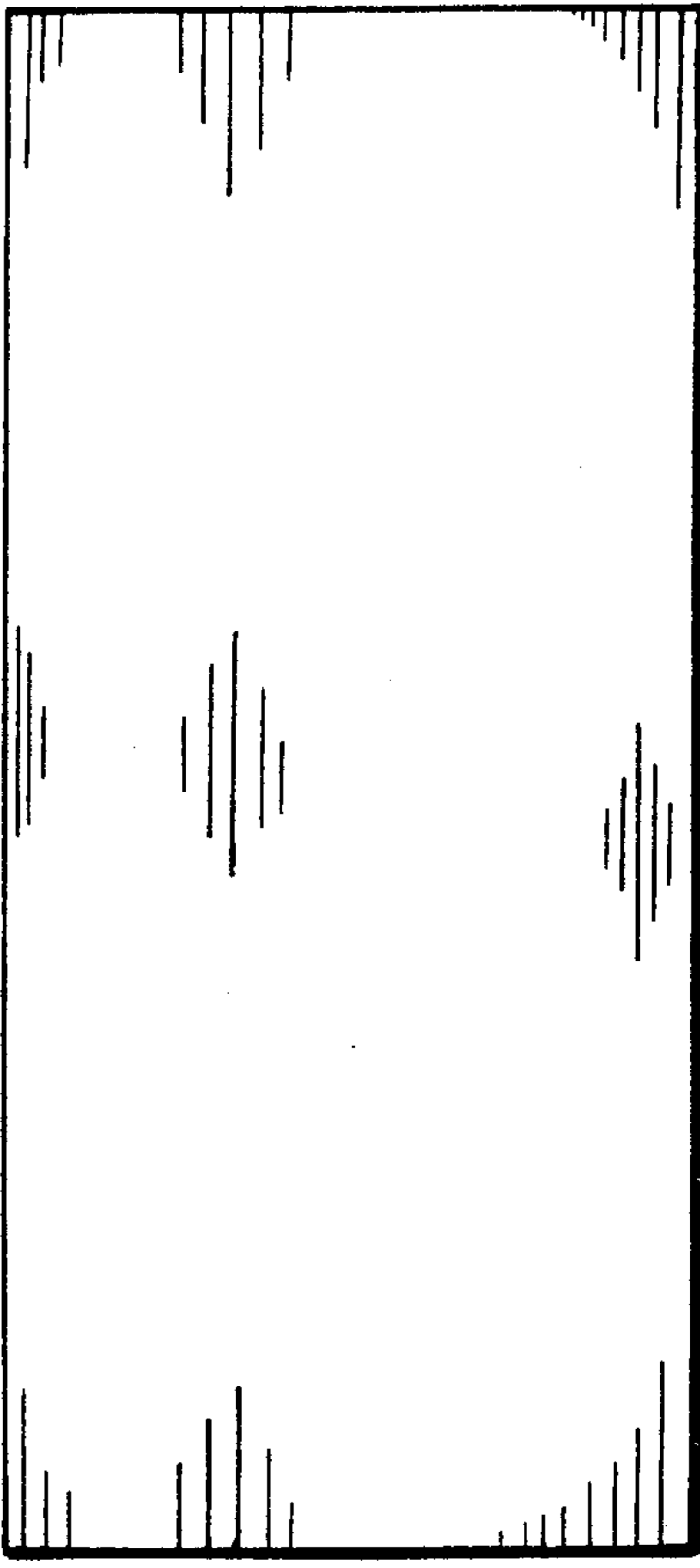

FIG. 3

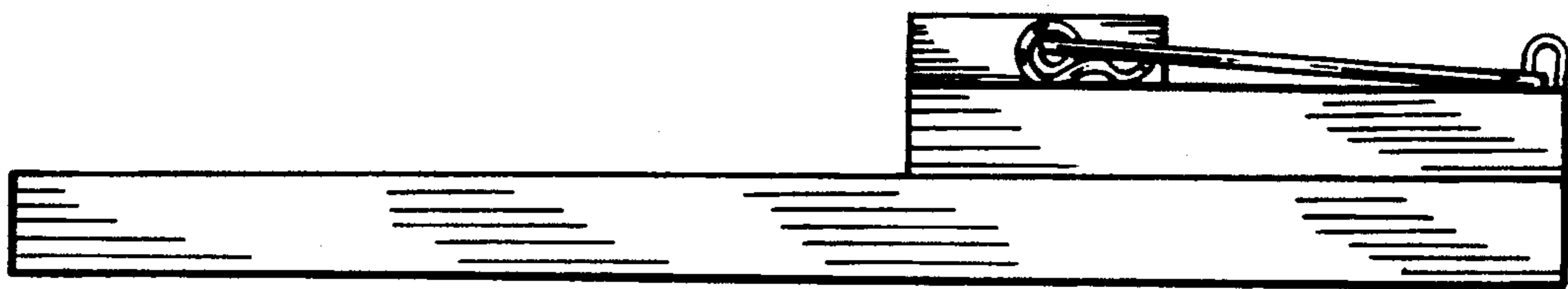

FIG. 4

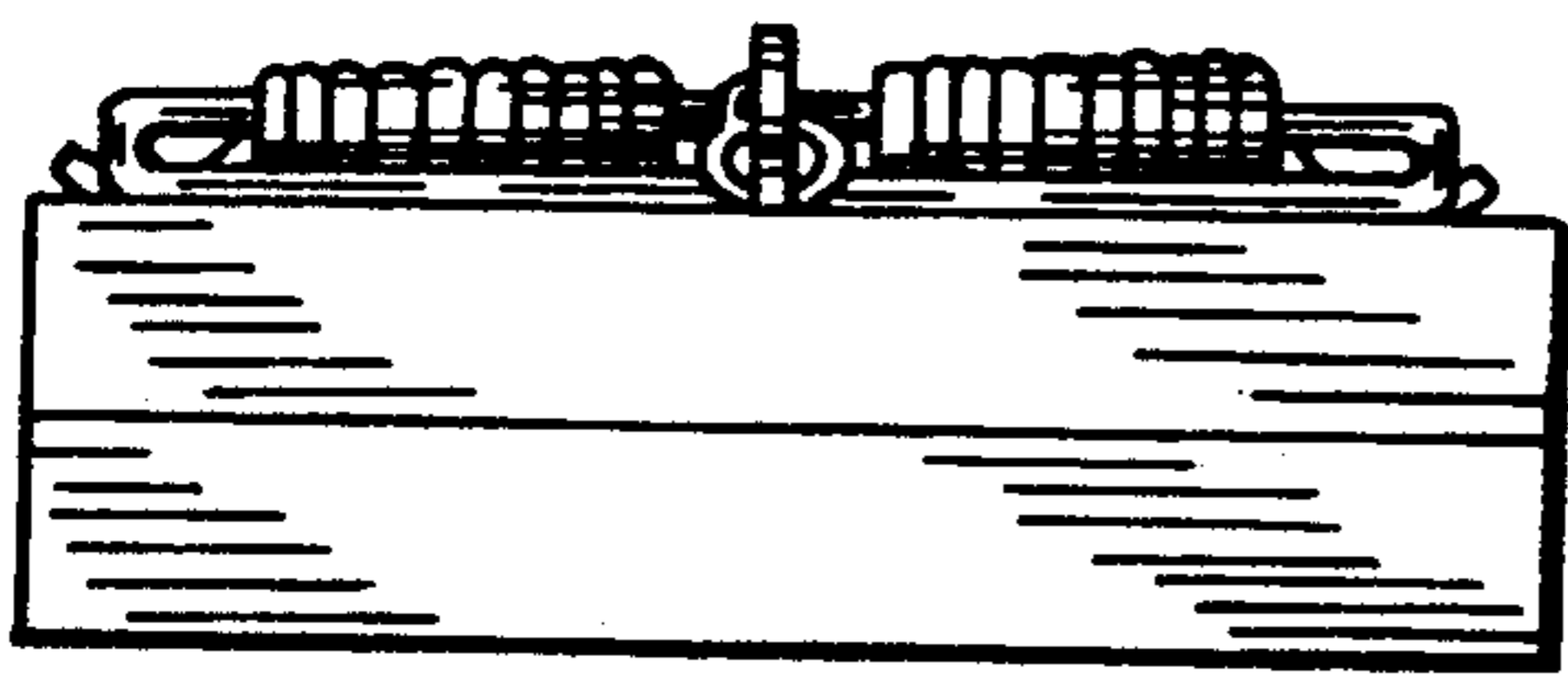

FIG. 5

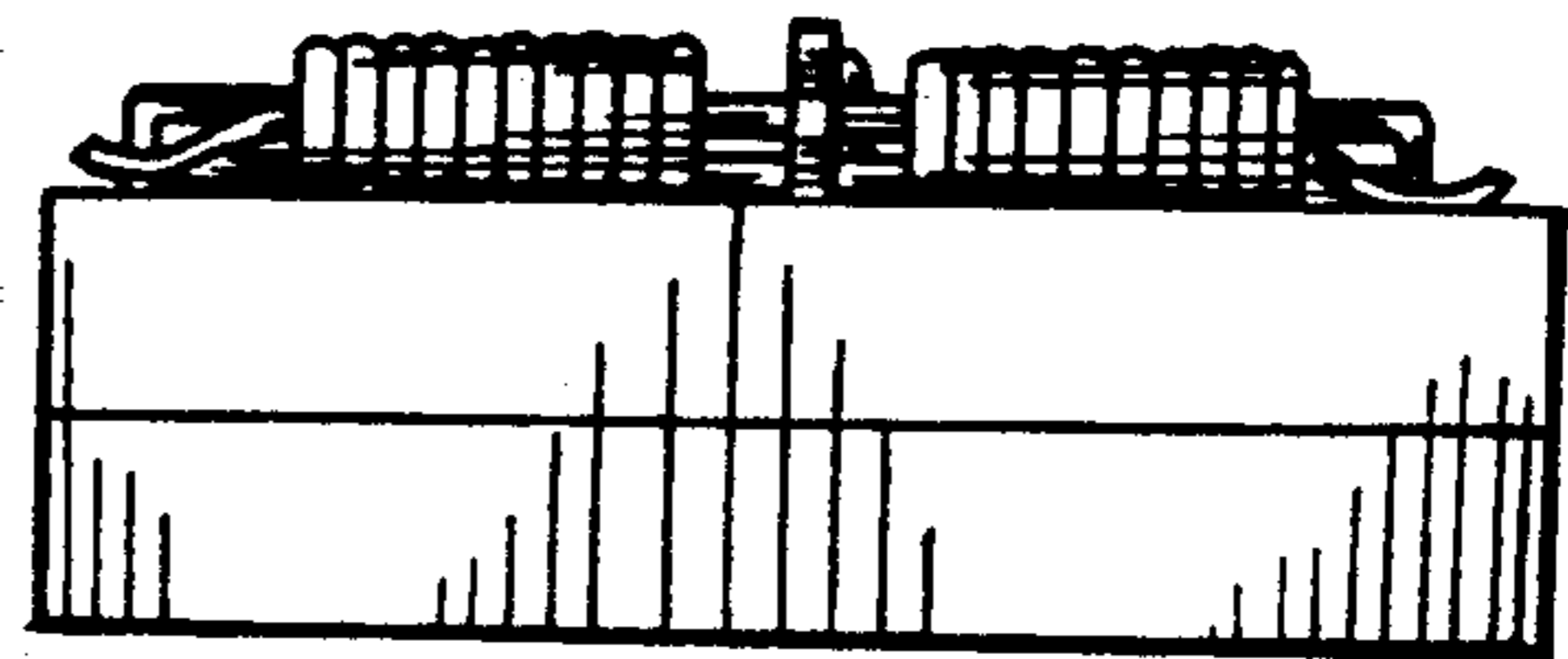

FIG. 6