



US00D329946S

United States Patent [19]

[11] Patent Number: **Des. 329,946**

Curtis et al.

[45] Date of Patent: **** Oct. 6, 1992**

[54] SET OF BRISTLES FOR A TOOTHBRUSH

[75] Inventors: **John P. Curtis**, Bloomsbury; **Kedar N. Rustogi**, Kendall Park, both of N.J.; **John C. Crawford**, Lake Mahopac, N.Y.; **James H. Kemp**, Piscataway, N.J.; **Thomas E. Mintel**, Rahway, N.J.; **Bert D. Heinzelman**, Tenafly, N.J.; **Donald R. Lamond**, Lynbrook; **Laura H. Edelman**, New York, both of N.Y.

3,359,588	12/1967	Kobler	15/167.1
3,722,020	3/1973	Hills	15/167.1
4,010,509	3/1977	Huish	15/167.1
4,033,008	7/1977	Warren et al.	15/167.1
4,051,571	10/1977	Ayers	15/167.1
4,268,933	5/1981	Papas	15/167.1
4,288,883	9/1981	Dolinsky	15/167.1
4,519,111	5/1985	Cavazza	15/167.1
4,706,322	11/1987	Nicolas	15/167.1
4,729,142	3/1988	Yoshioka	15/167.1
4,776,054	10/1988	Rauch	15/167.1
4,802,255	2/1989	Breuer et al.	15/159 A

[73] Assignee: **Colgate-Palmolive Company**, New York, N.Y.

FOREIGN PATENT DOCUMENTS

1139096	11/1962	Fed. Rep. of Germany	15/167.1
324623	11/1957	Switzerland .	

[**] Term: **14 Years**

Primary Examiner—Wallace R. Burke
Assistant Examiner—Lavone D. Tabor
Attorney, Agent, or Firm—Richard J. Ancel; Robert C. Sullivan

[21] Appl. No.: **501,628**

[22] Filed: **Mar. 29, 1990**

[52] U.S. Cl. **D4/104**

[58] Field of Search D4/101, 104-114, D4/130, 132, 134, 136, 199; D28/64; 15/22.1-22.2, 23-28, 159 R, 159 A, 160, 143 R, 167.1-167.3, 176.1, DIG. 5-6; 132/308-311

[57] **CLAIM**

The ornamental design for a set of bristles for a toothbrush, as shown and described.

DESCRIPTION

FIG. 1 is a top plan view of a set of bristles for a toothbrush showing our new design; FIG. 2 is a right side elevational view thereof; FIG. 3 is an elevational view as seen from the left end of FIG. 1; FIG. 4 is a right end elevational view thereof; FIG. 5 is a left side elevational view thereof; and, FIG. 6 is a perspective view thereof.

[56] **References Cited**

U.S. PATENT DOCUMENTS

D. 172,693	7/1954	Wibbelsman et al.	D4/104
1,382,681	6/1921	Segal	15/167.1
2,168,964	8/1939	Strasser	15/167.1
2,429,740	10/1947	Aufsesser	15/167.1
2,567,080	9/1951	Pifer	15/167.1
3,229,318	1/1966	Clemens	15/167.1

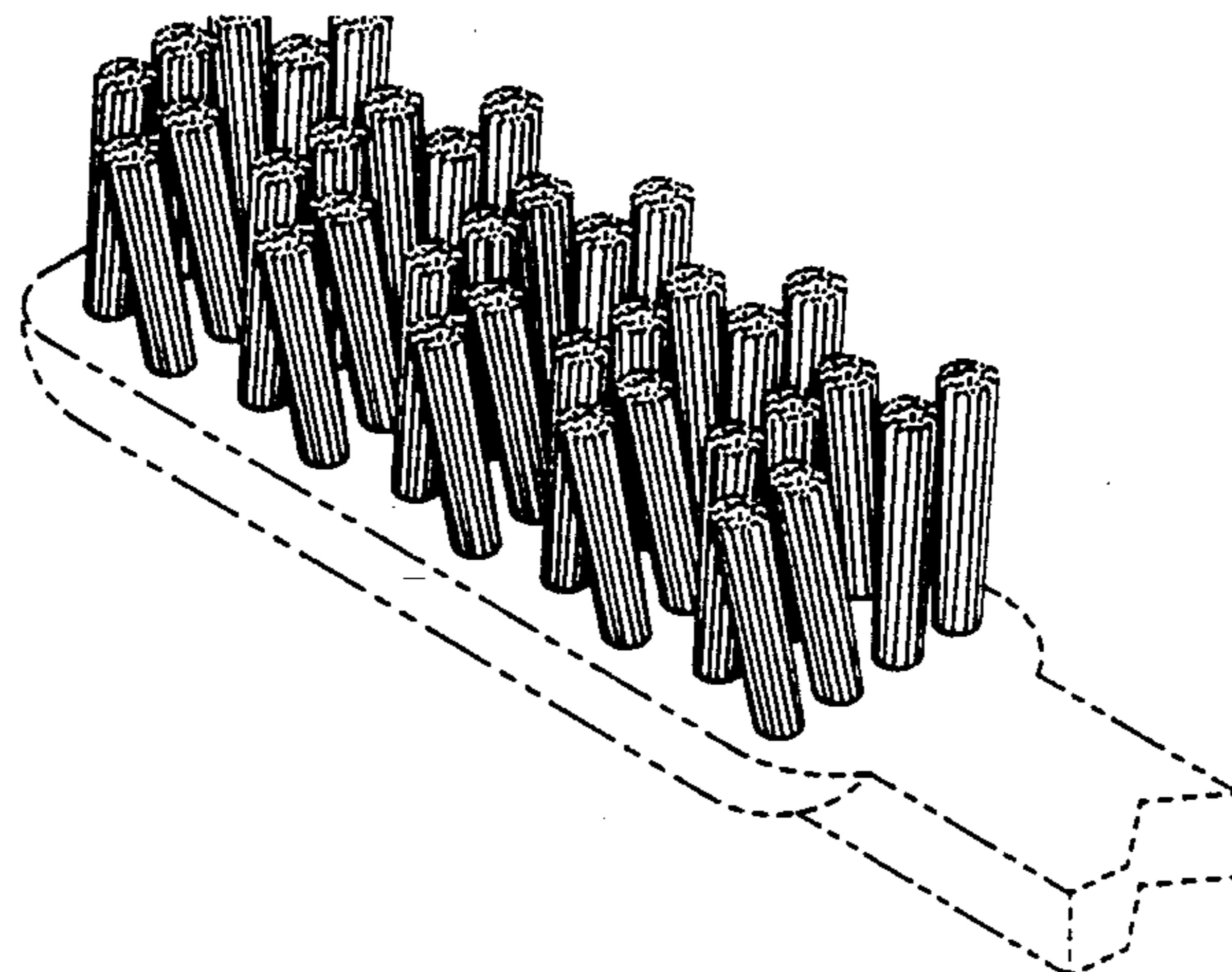
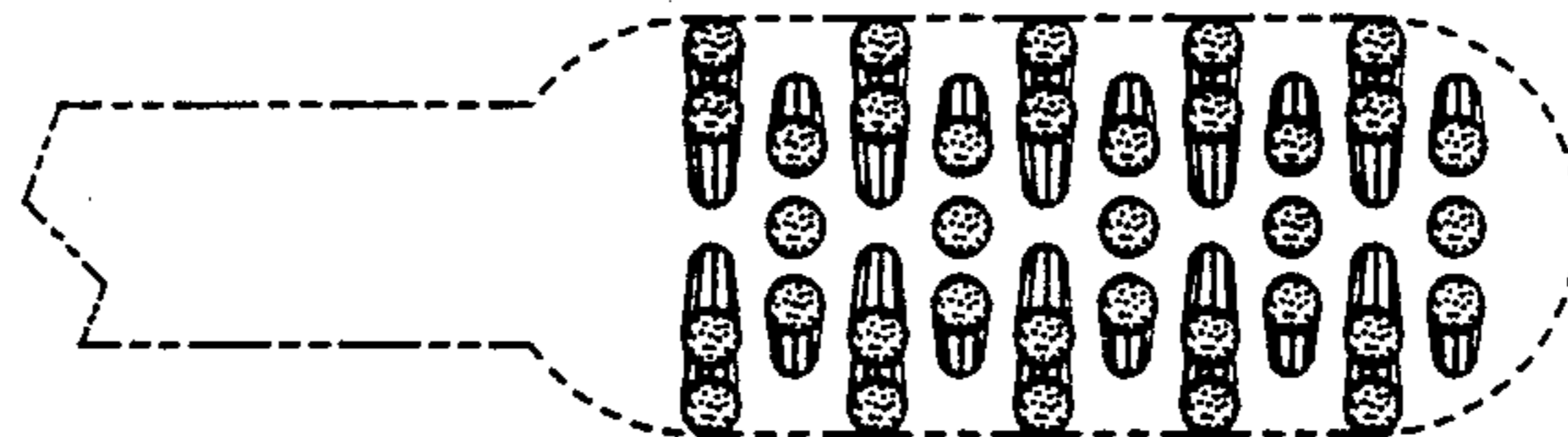

FIG. 1

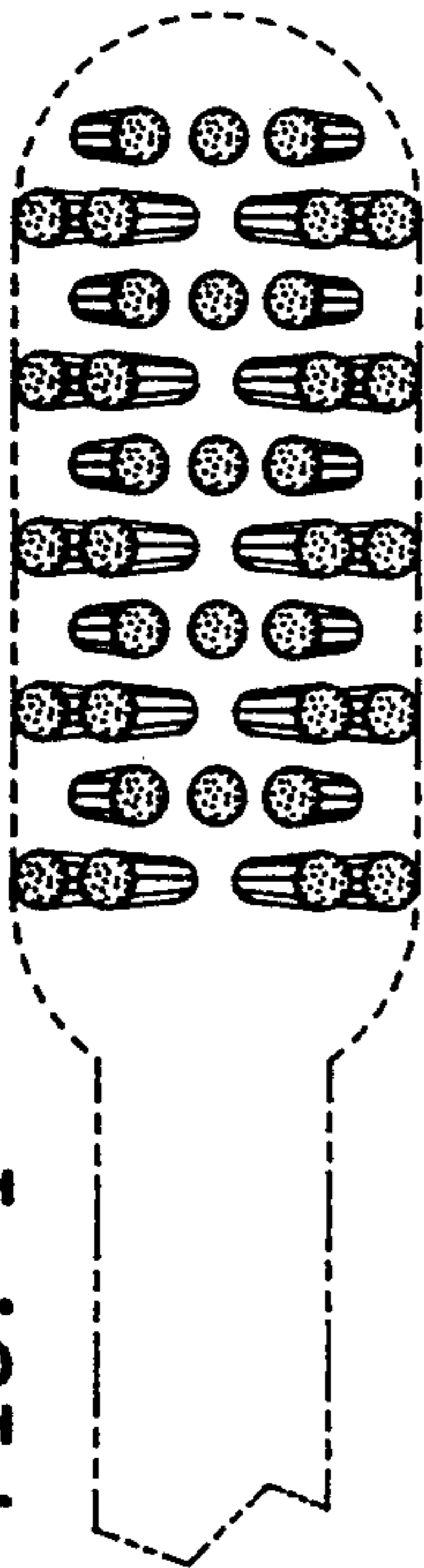

FIG. 4

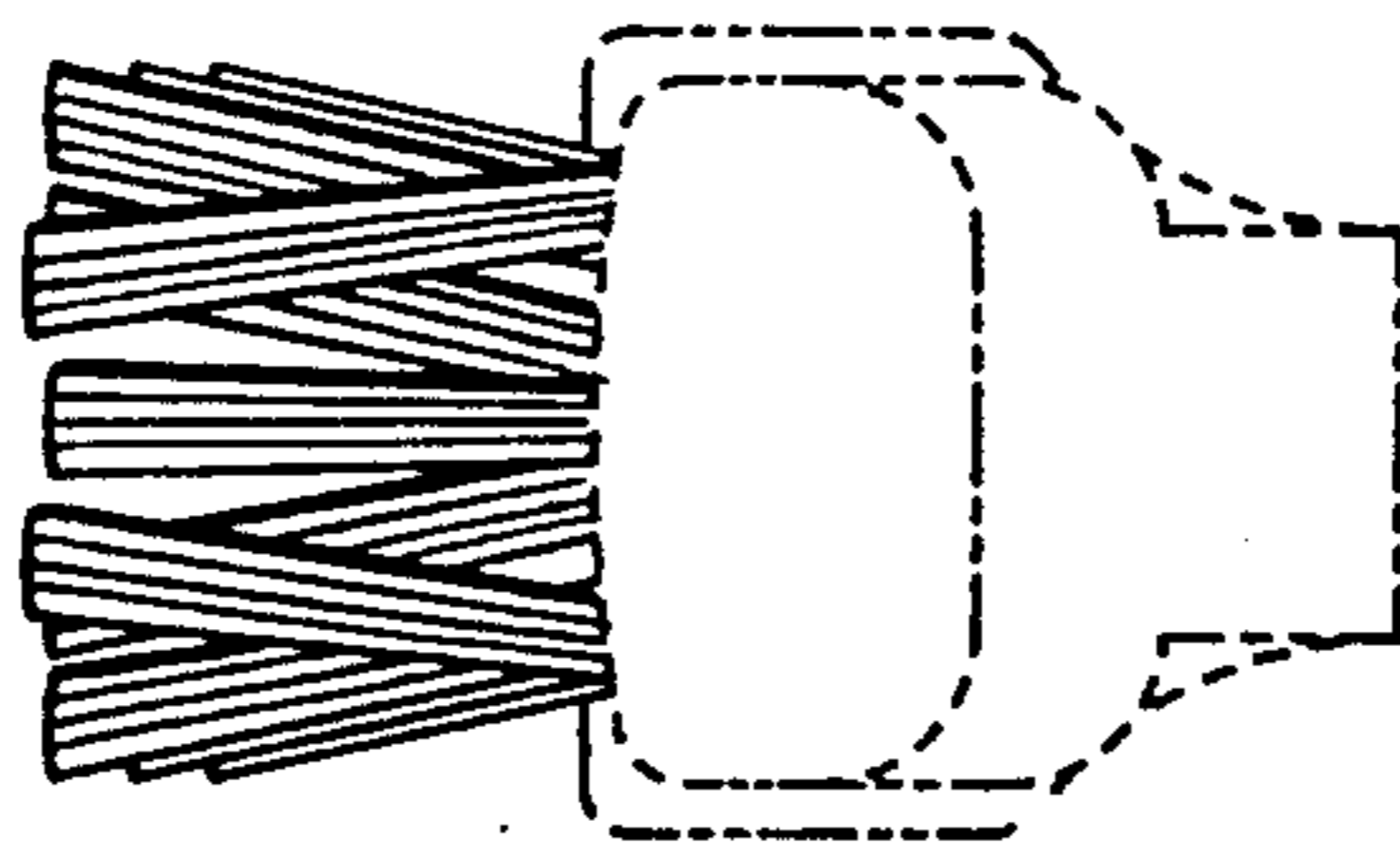

FIG. 2

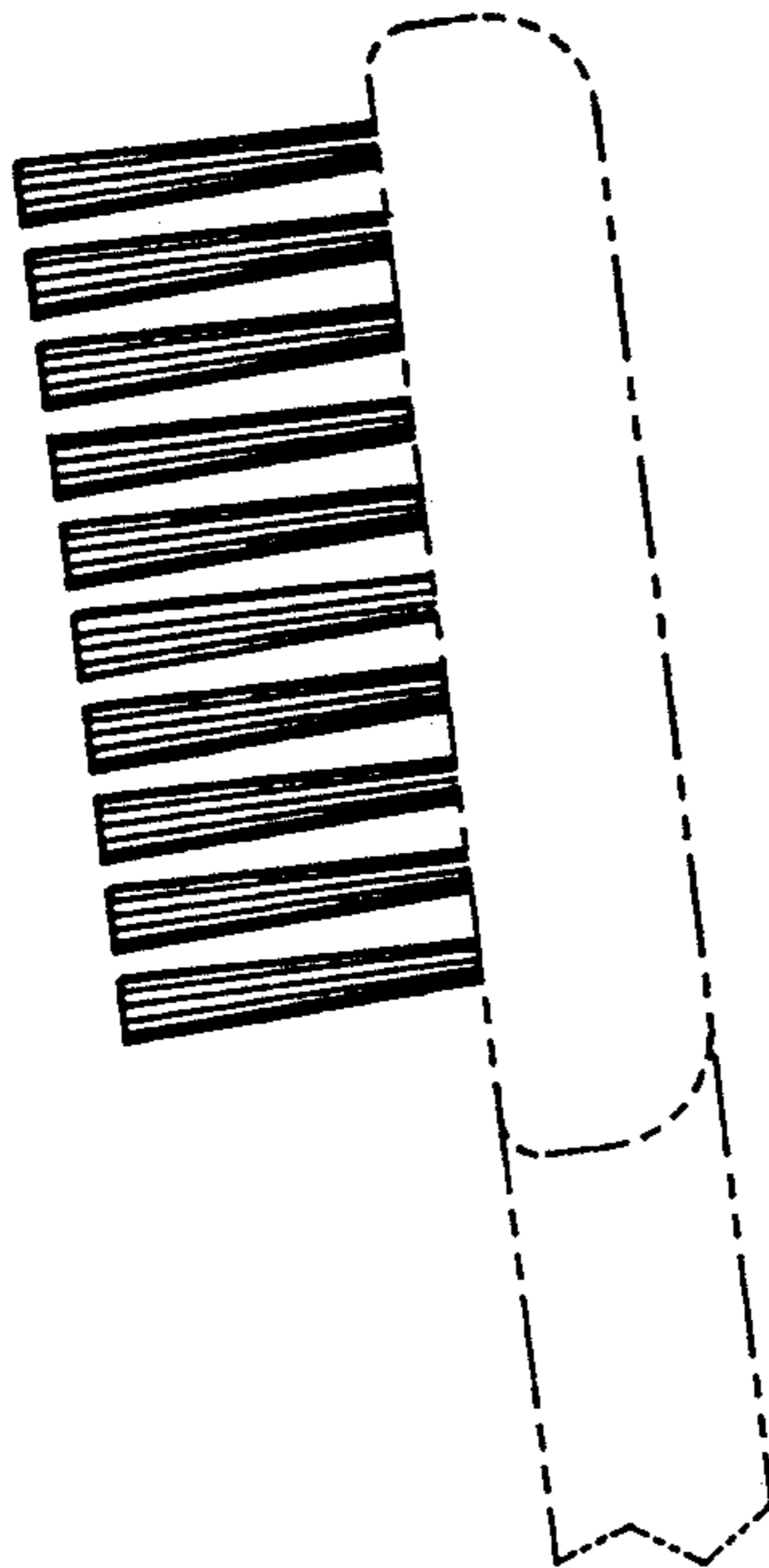

FIG. 5

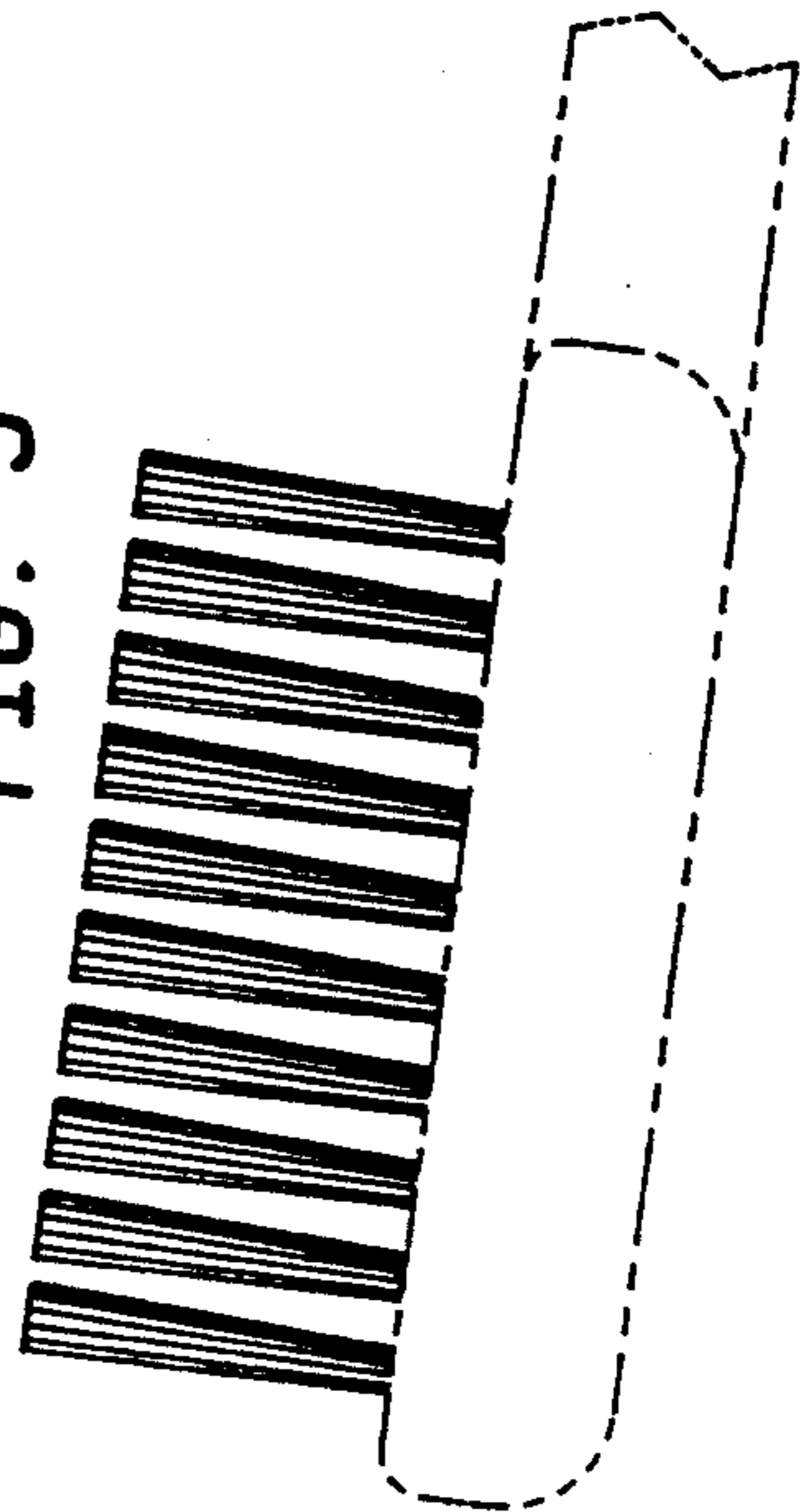

FIG. 6

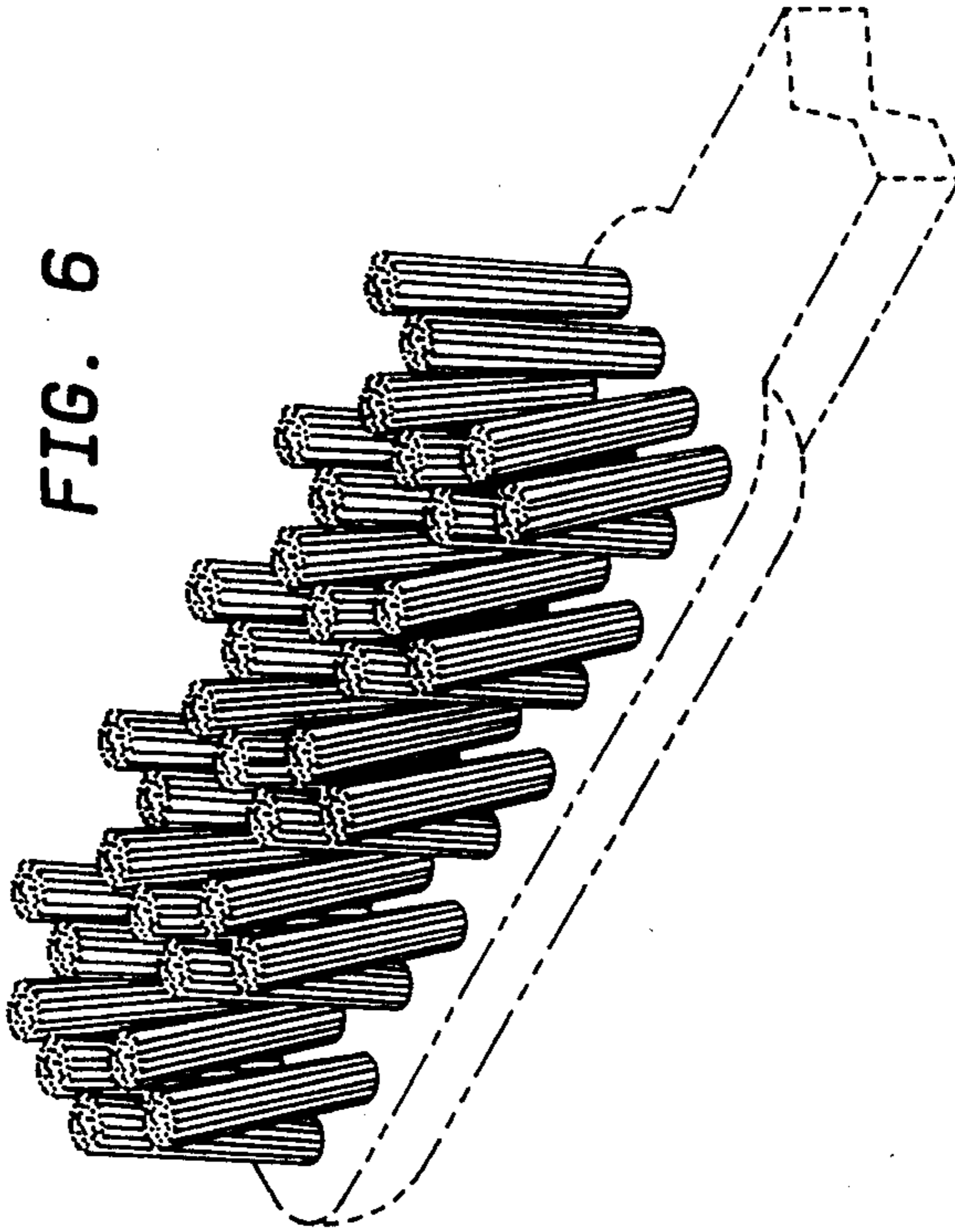

FIG. 3

