



US00D329912S

United States Patent [19] Grohe

[11] Patent Number: **Des. 329,912**

[45] Date of Patent: **** Sep. 29, 1992**

[54] FAUCET HANDLE

[75] Inventor: **Klaus Grohe, Schiltach, Fed. Rep. of Germany**

[73] Assignee: **Hans Grohe GmbH & Co. KG, Fed. Rep. of Germany**

[**] Term: **14 Years**

[21] Appl. No.: **350,536**

[22] Filed: **May 11, 1989**

[30] Foreign Application Priority Data

Nov. 14, 1988 [DE] Fed. Rep. of Germany M8803312.0

[52] U.S. Cl. **D23/252**

[58] Field of Search **D23/238-243, D23/250-259; D8/300, 307-312; 4/191, 192; 16/110, 118, 121**

[56] References Cited

U.S. PATENT DOCUMENTS

D. 254.088 1/1980 Haug D23/252
D. 291.238 8/1987 Haug et al. D23/252

D. 306,336 2/1990 Oberdorfer D23/252
1,701,776 2/1929 Hinman 16/121

OTHER PUBLICATIONS

Domestic Engineering Feb. 1987, p. 55, handle on left faucet.

Primary Examiner—James R. Largen
Attorney, Agent, or Firm—Eckert Seamans Cherin & Mellott

[57] CLAIM

The ornamental design for a faucet handle, as shown or described.

DESCRIPTION

FIG. 1 is a perspective view taken from the top, front and right side of a faucet handle showing my new design;
FIG. 2 is a top plan view thereof;
FIG. 3 is a right side elevational view thereof;
FIG. 4 is a rear elevational view thereof;
FIG. 5 is a front elevational view thereof;
FIG. 6 is a left side elevational view thereof; and,
FIG. 7 is a bottom plan view thereof.

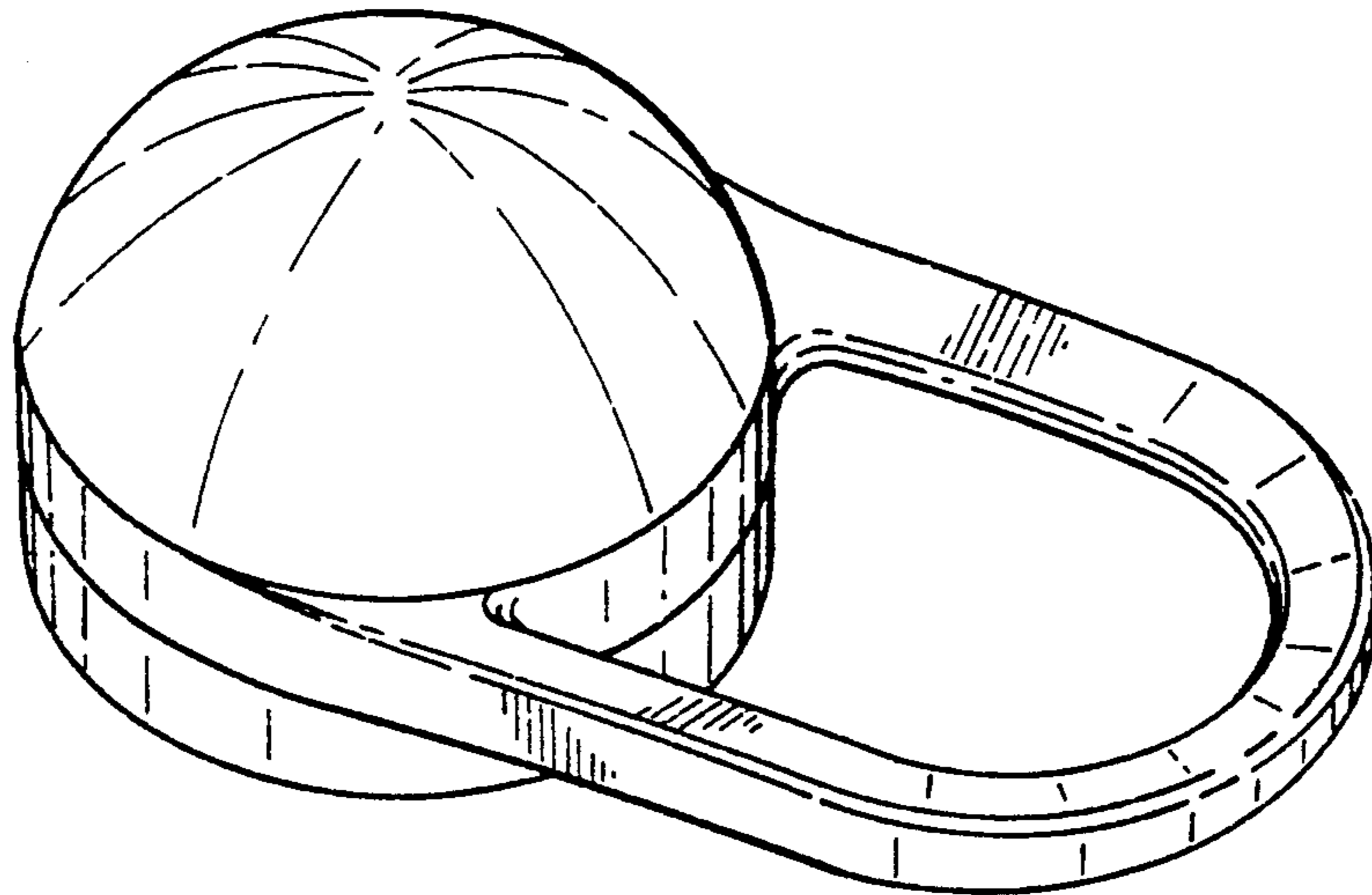
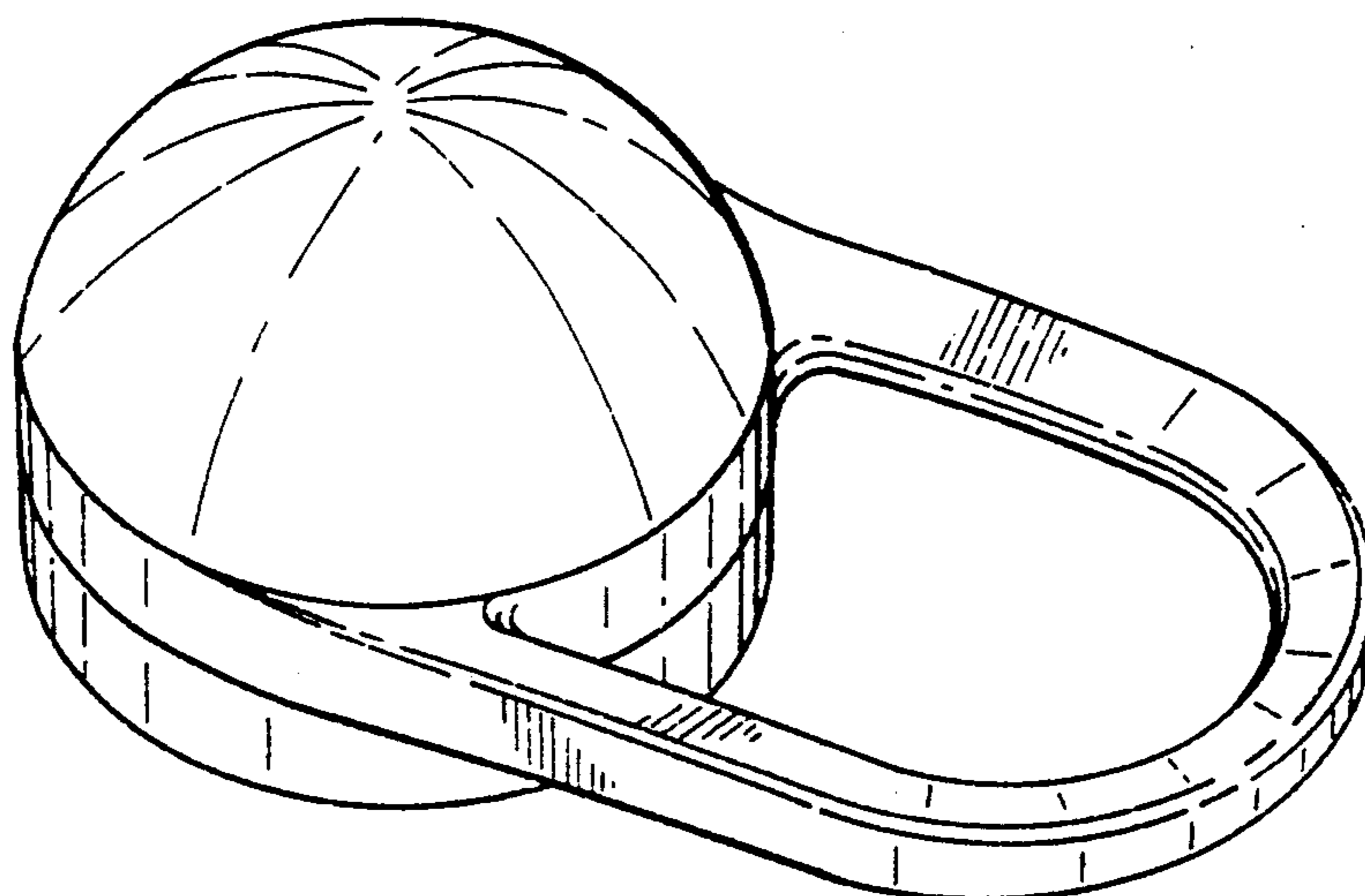

FIG. 1



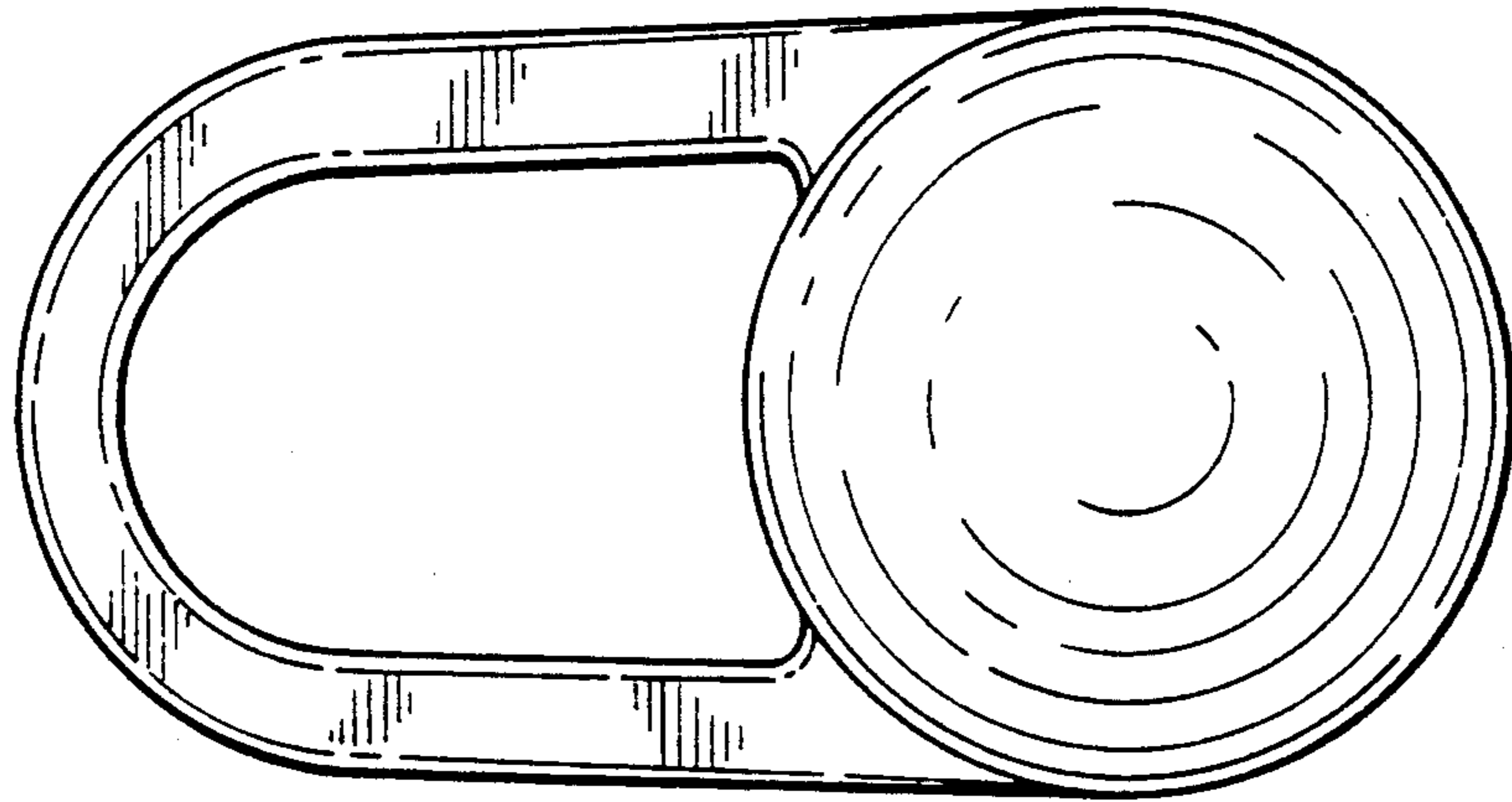

FIG. 2

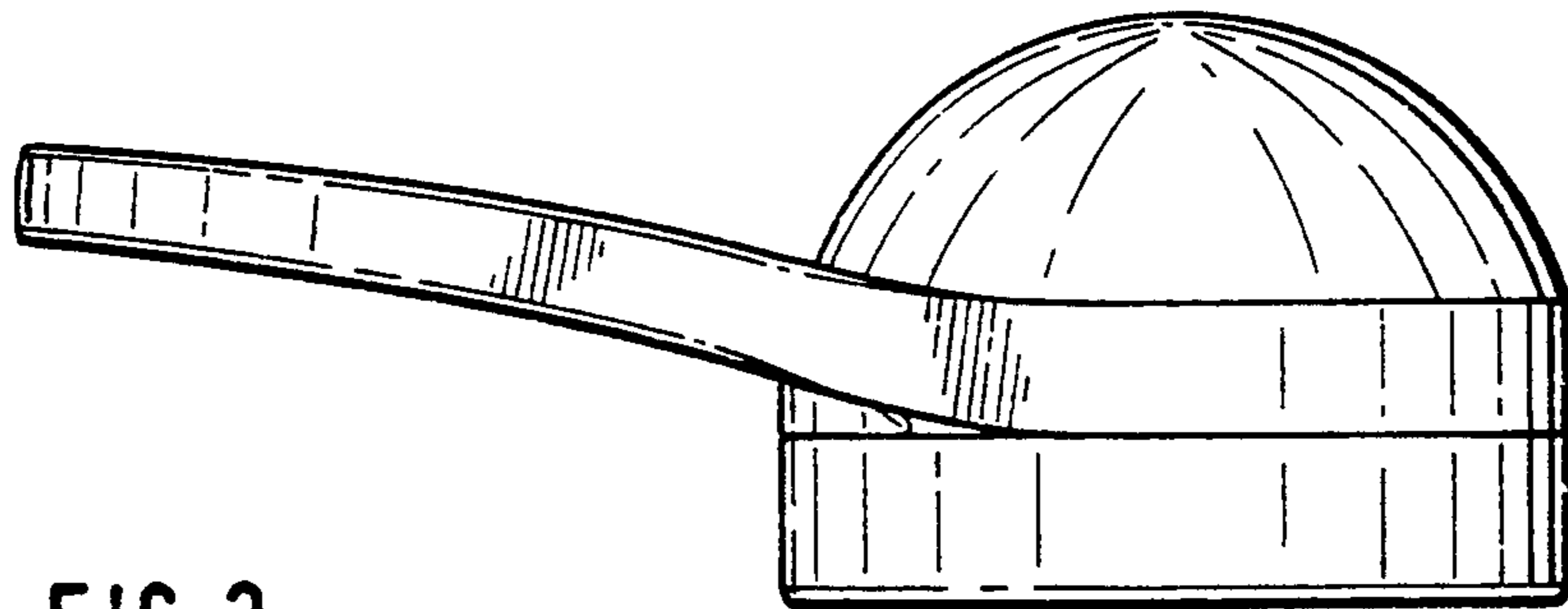

FIG. 3

FIG. 4

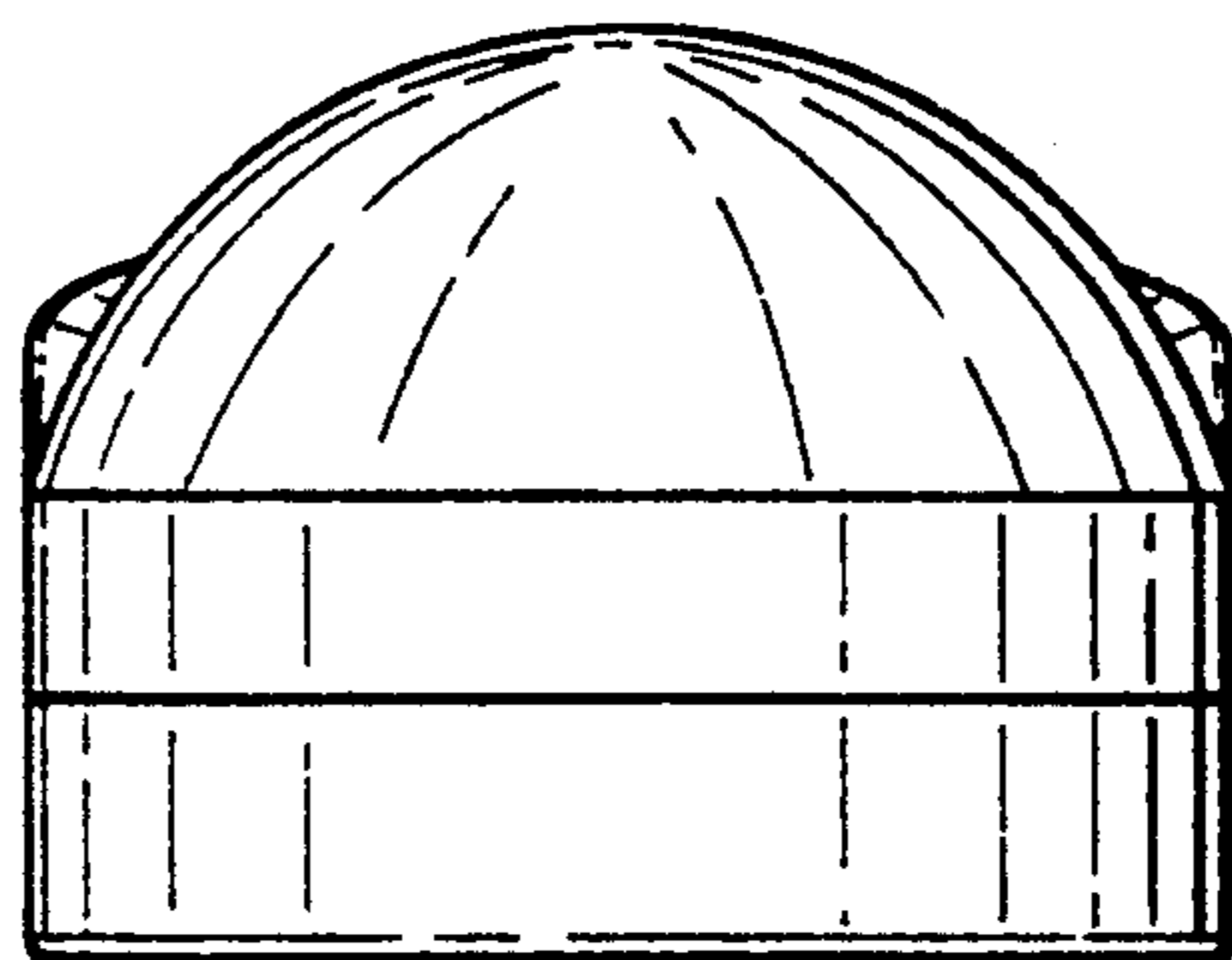

FIG. 5

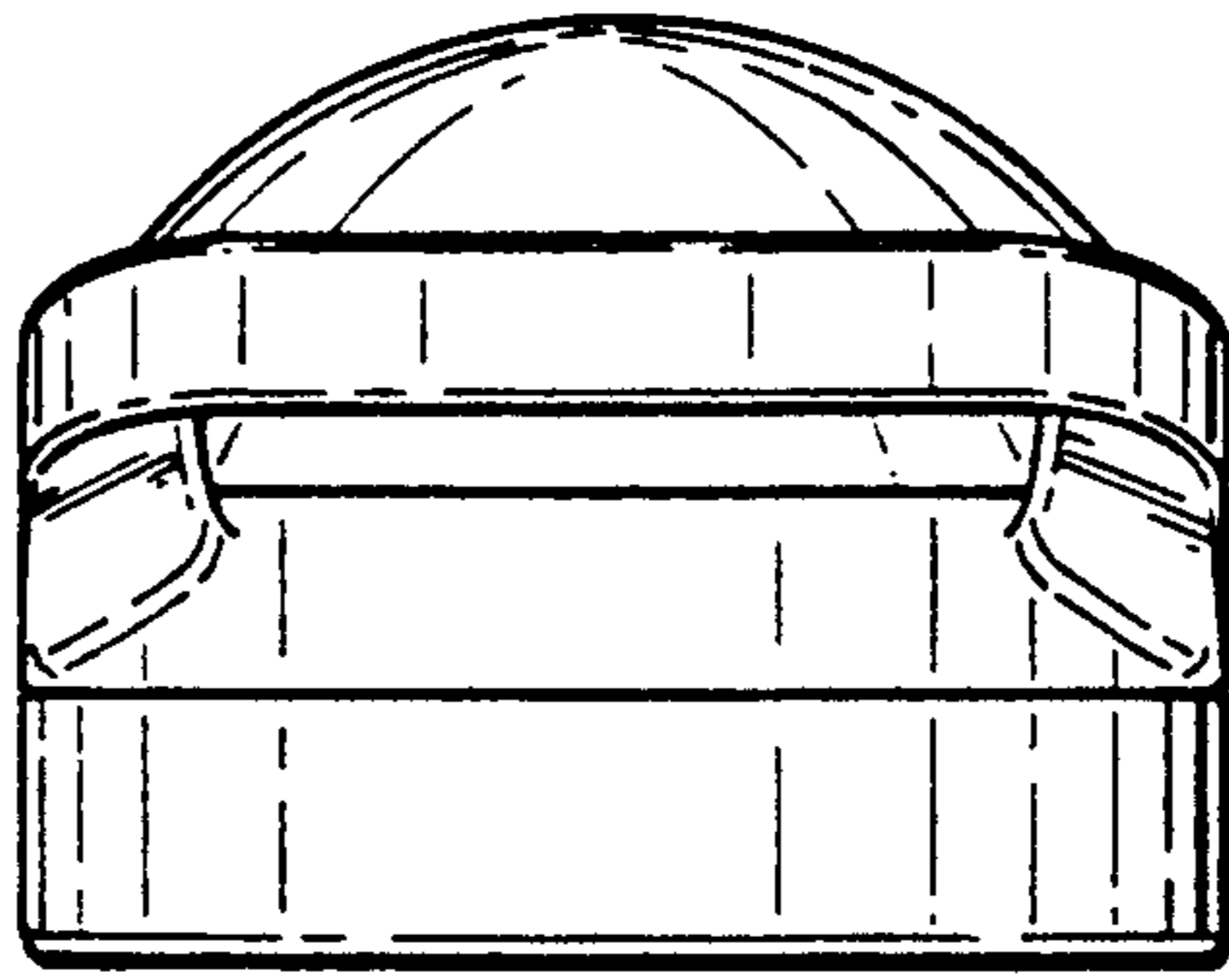

FIG. 6

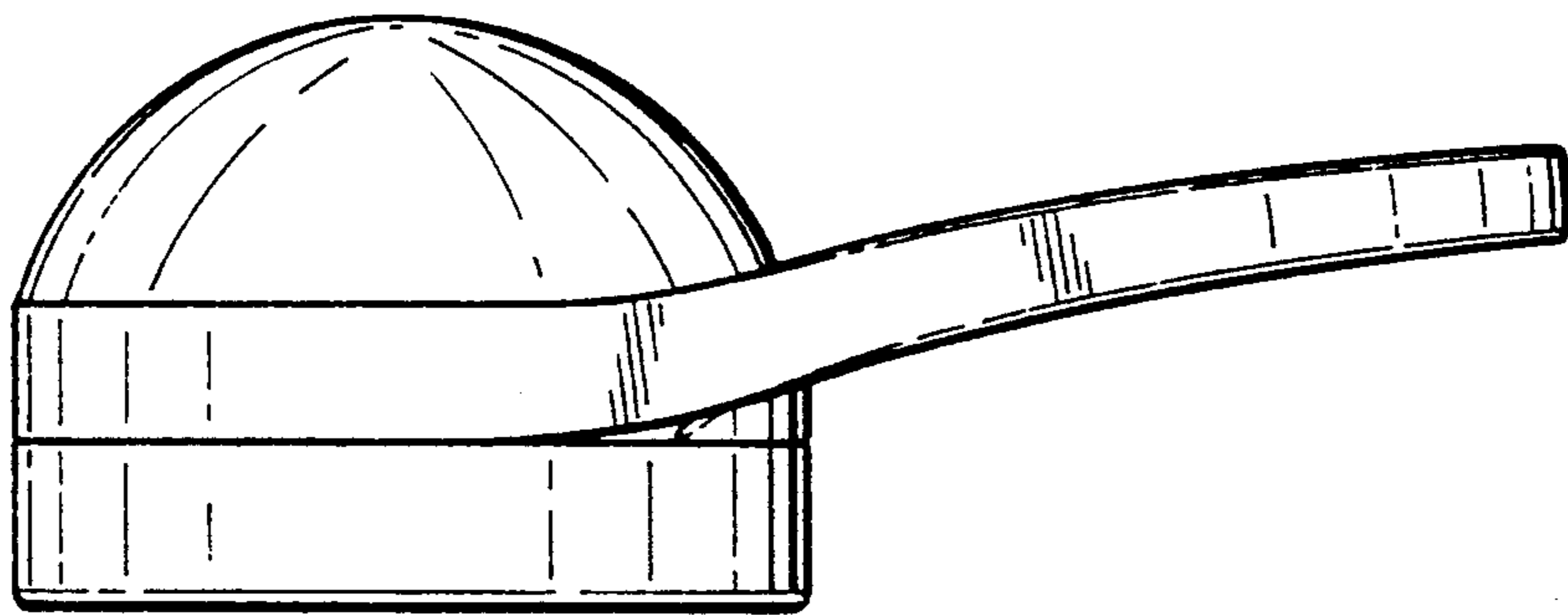
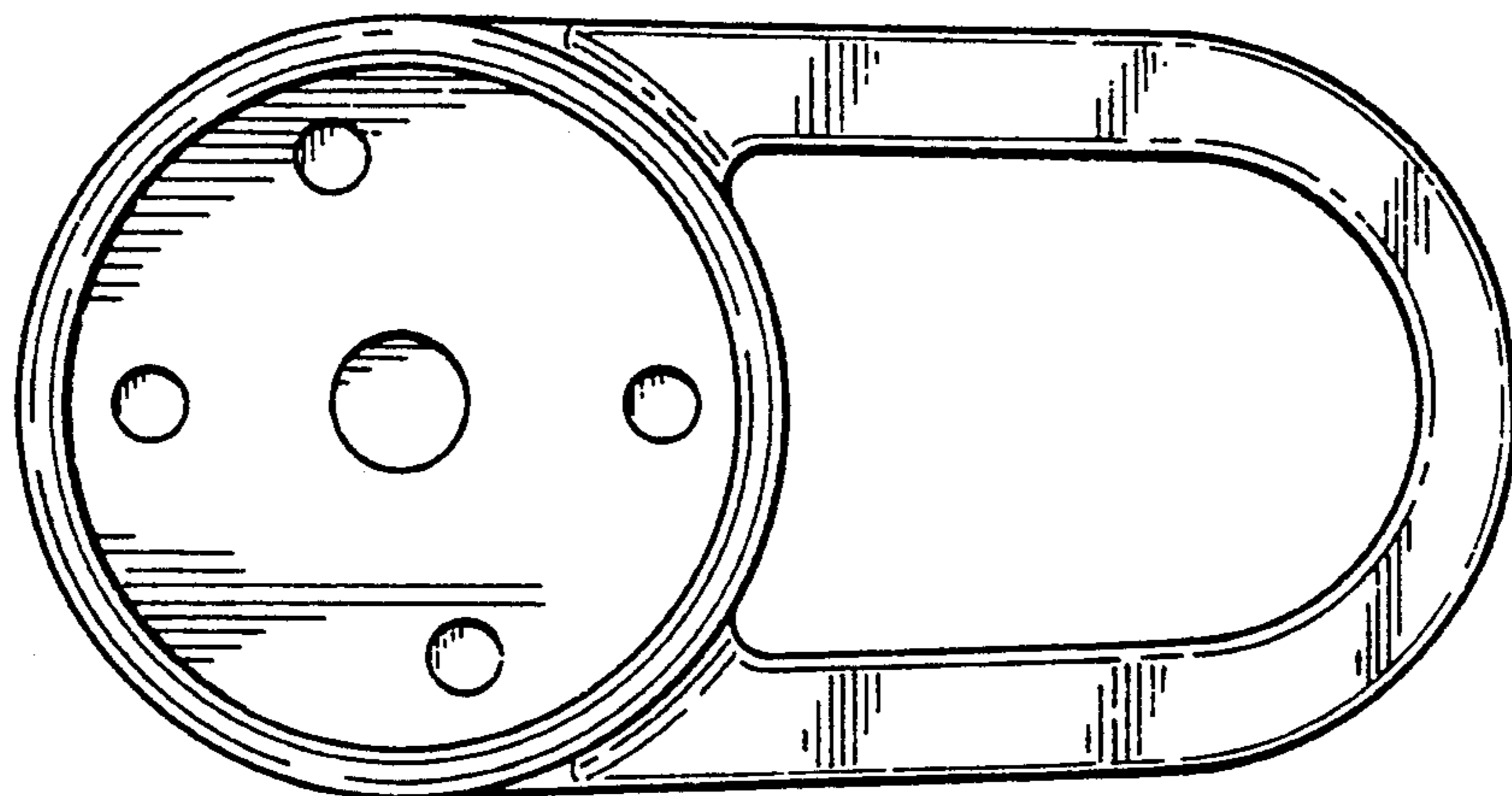

FIG. 7



UNITED STATES PATENT AND TRADEMARK OFFICE
CERTIFICATE OF CORRECTION

PATENT NO. : Des. 329,912
DATED : Sep. 29, 1992
INVENTOR(S) : Klaus Grohe

Page 1 of 5

It is certified that error appears in the above-identified patent and that said Letters Patent is hereby corrected as shown below:

The title page, should be deleted to be replaced with the attached title page.

The drawing sheets should be deleted to be replaced with the attached drawing sheets.

Signed and Sealed this
Third Day of May, 1994



BRUCE LEHMAN

Commissioner of Patents and Trademarks

Attest:

Attesting Officer

United States Patent [19]

Grohe

[11] **Patent Number: Des. 329,912**

[45] **Date of Patent: ** Sep. 29, 1992**

[54] **FAUCET HANDLE**

[75] **Inventor: Klaus Grohe, Schiltach, Fed. Rep. of Germany**

[73] **Assignee: Hans Grohe GmbH & Co. KG, Fed. Rep. of Germany**

[**] **Term: 14 Years**

[21] **Appl. No.: 350,536**

[22] **Filed: May 11, 1989**

[30] **Foreign Application Priority Data**

Nov 14, 1988 [DE] Fed Rep of Germany M8803312.0

[52] **U.S. Cl. D23/252**

[58] **Field of Search D23/238-243, D23/250-259, D8/300, 307-312, 4/191, 192, 16/110, 118, 121**

[56] **References Cited**

U.S. PATENT DOCUMENTS

D 254,088 1/1980 Haug D23/252
 D 291,238 8/1987 Haug et al D23/252

D. 306.336 2/1990 Oberdorfer D23/252
 1,701.776 2/1929 Hinman 16/121

OTHER PUBLICATIONS

Domestic Engineering Feb. 1987, p. 55, handle on left faucet.

Primary Examiner—James R. Largen
Attorney, Agent, or Firm—Eckert Seamans Cherin & Mellott

[57] **CLAIM**

The ornamental design for a faucet handle, as shown or described.

DESCRIPTION

FIG. 1 is a perspective view taken from the top, front and right side of a faucet handle showing my new design;

FIG. 2 is a top plan view thereof;

FIG. 3 is a right side elevational view thereof;

FIG. 4 is a rear elevational view thereof;

FIG. 5 is a front elevational view thereof;

FIG. 6 is a left side elevational view thereof; and,

FIG. 7 is a bottom plan view thereof.

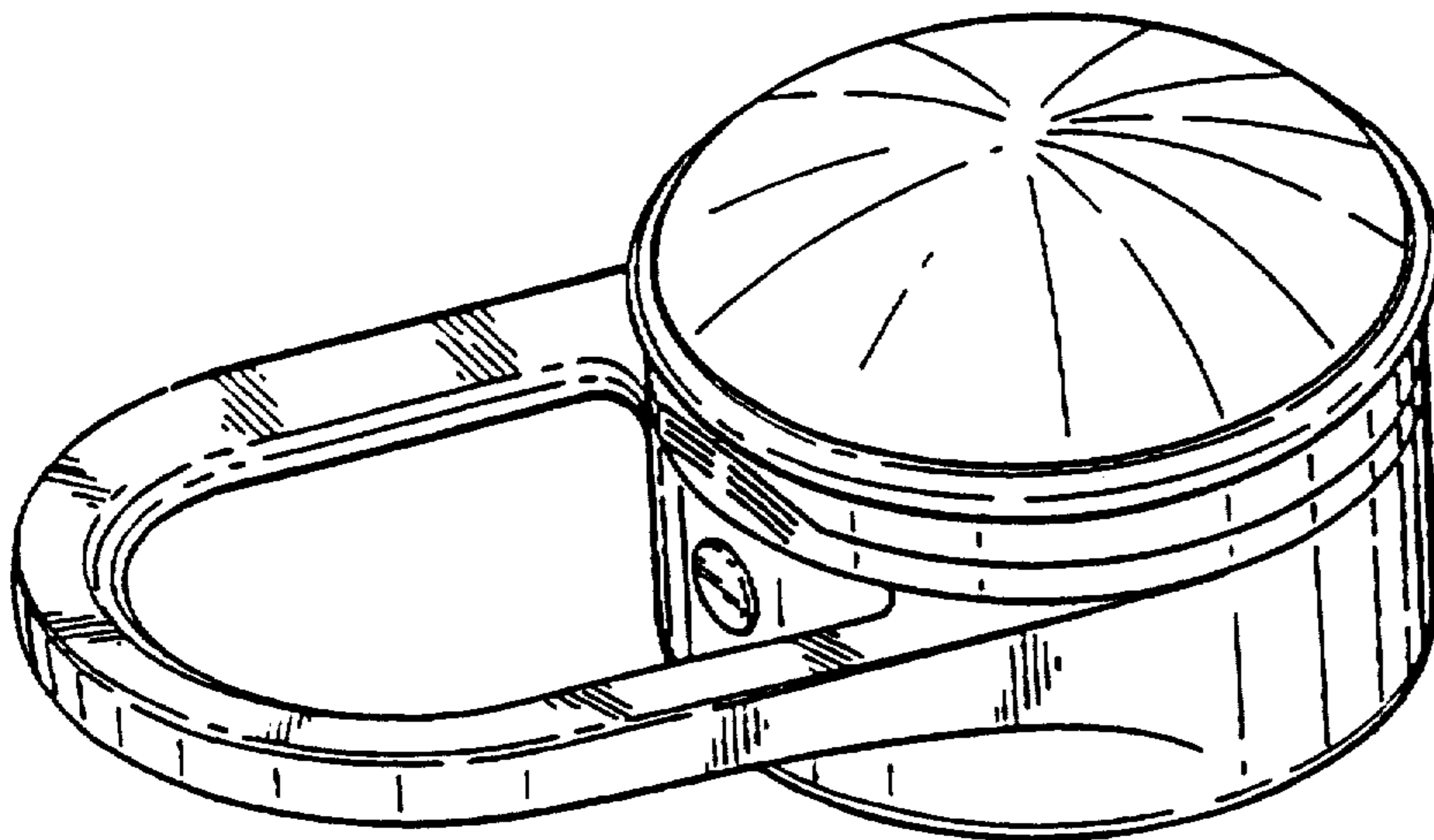
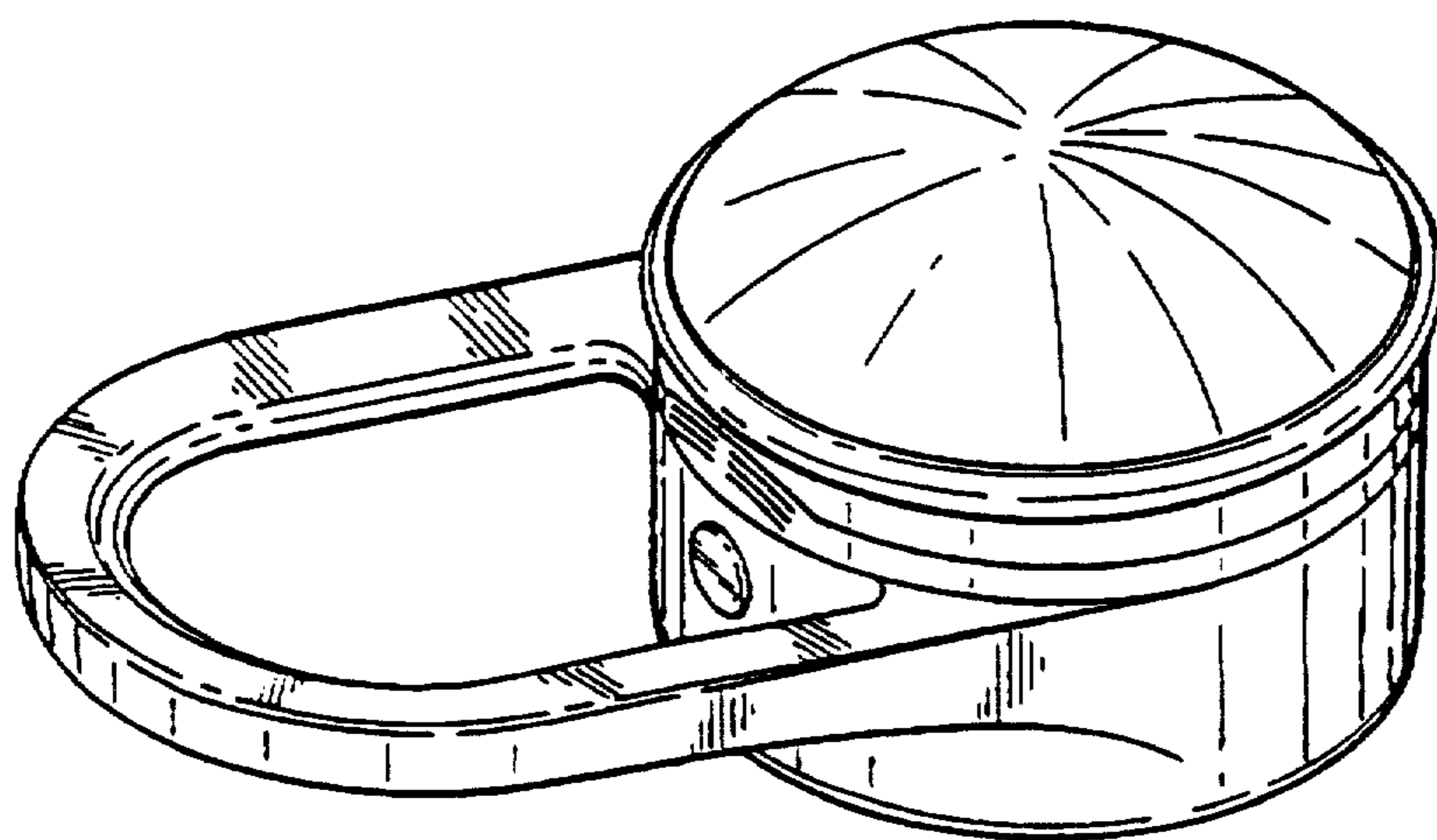

FIG. 1



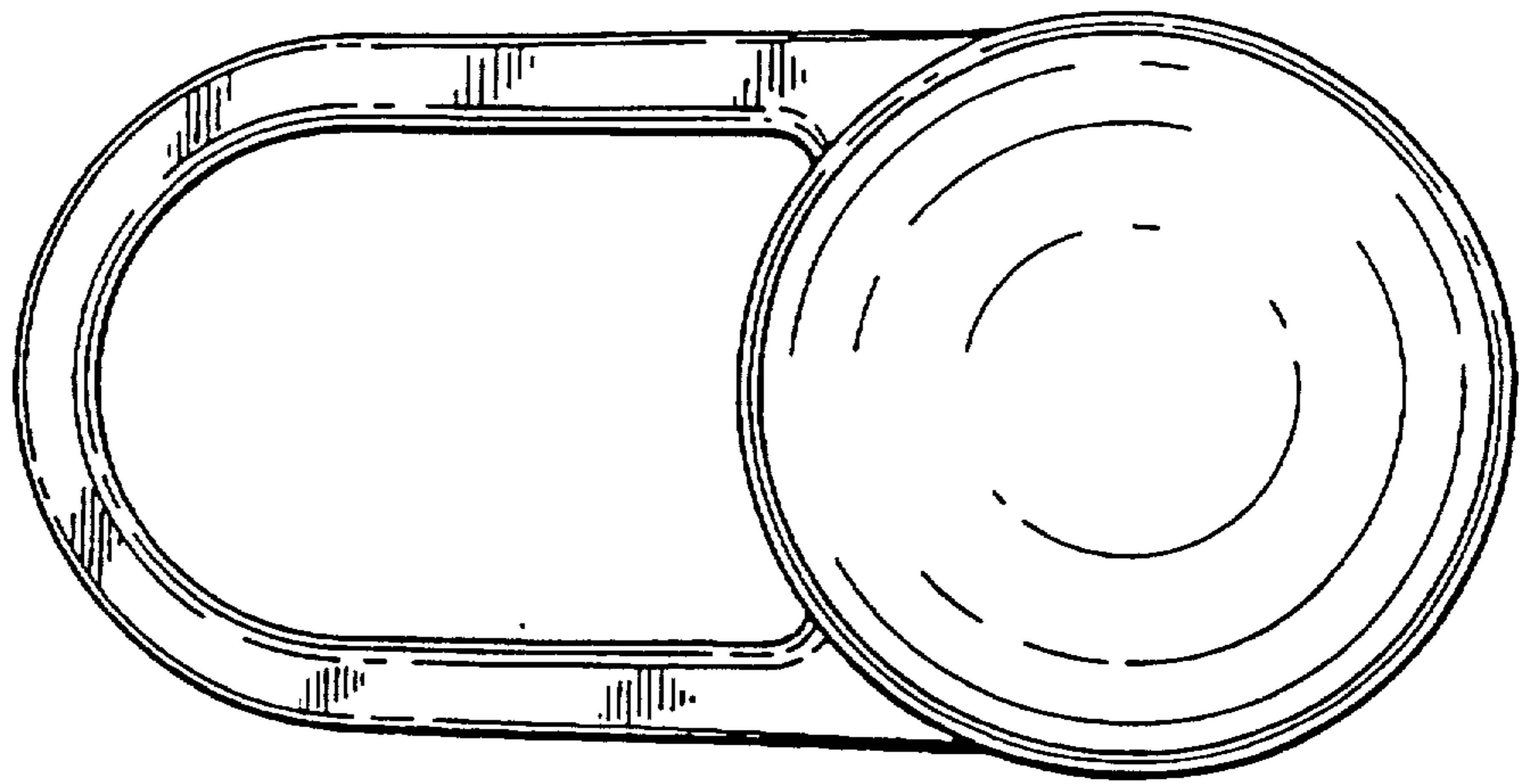

FIG. 2

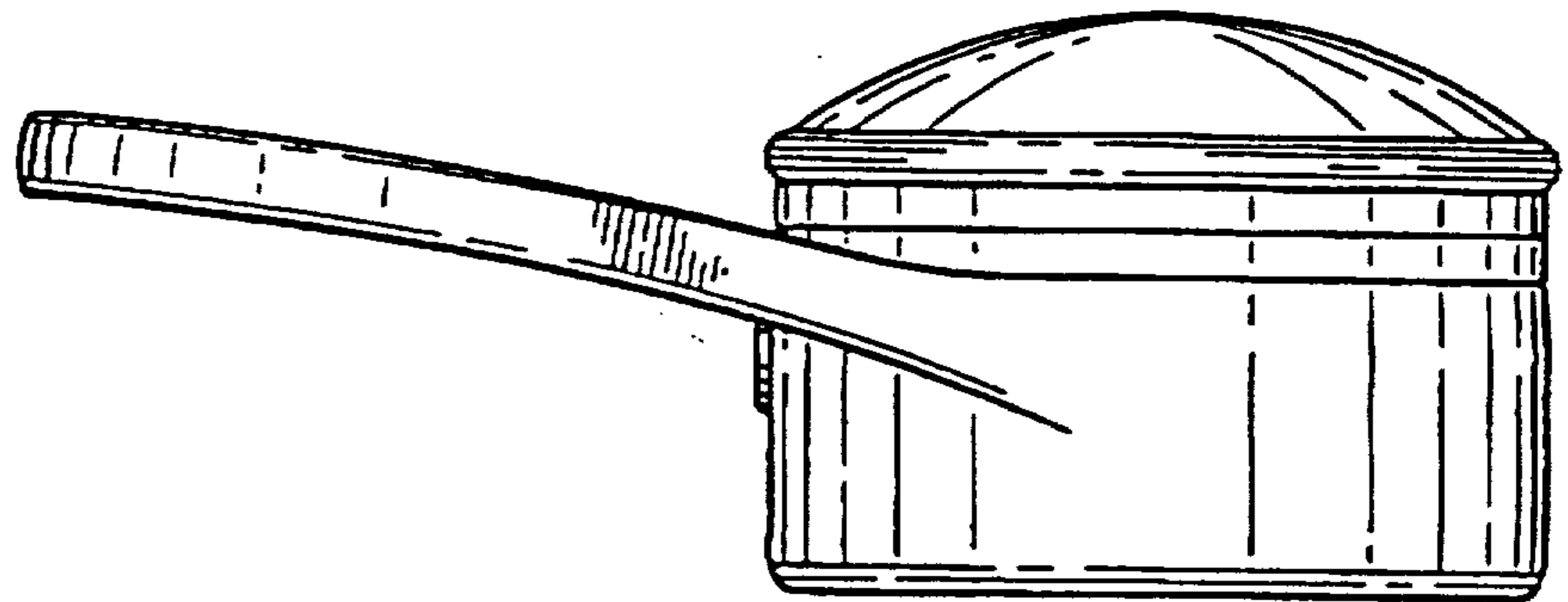

FIG. 3

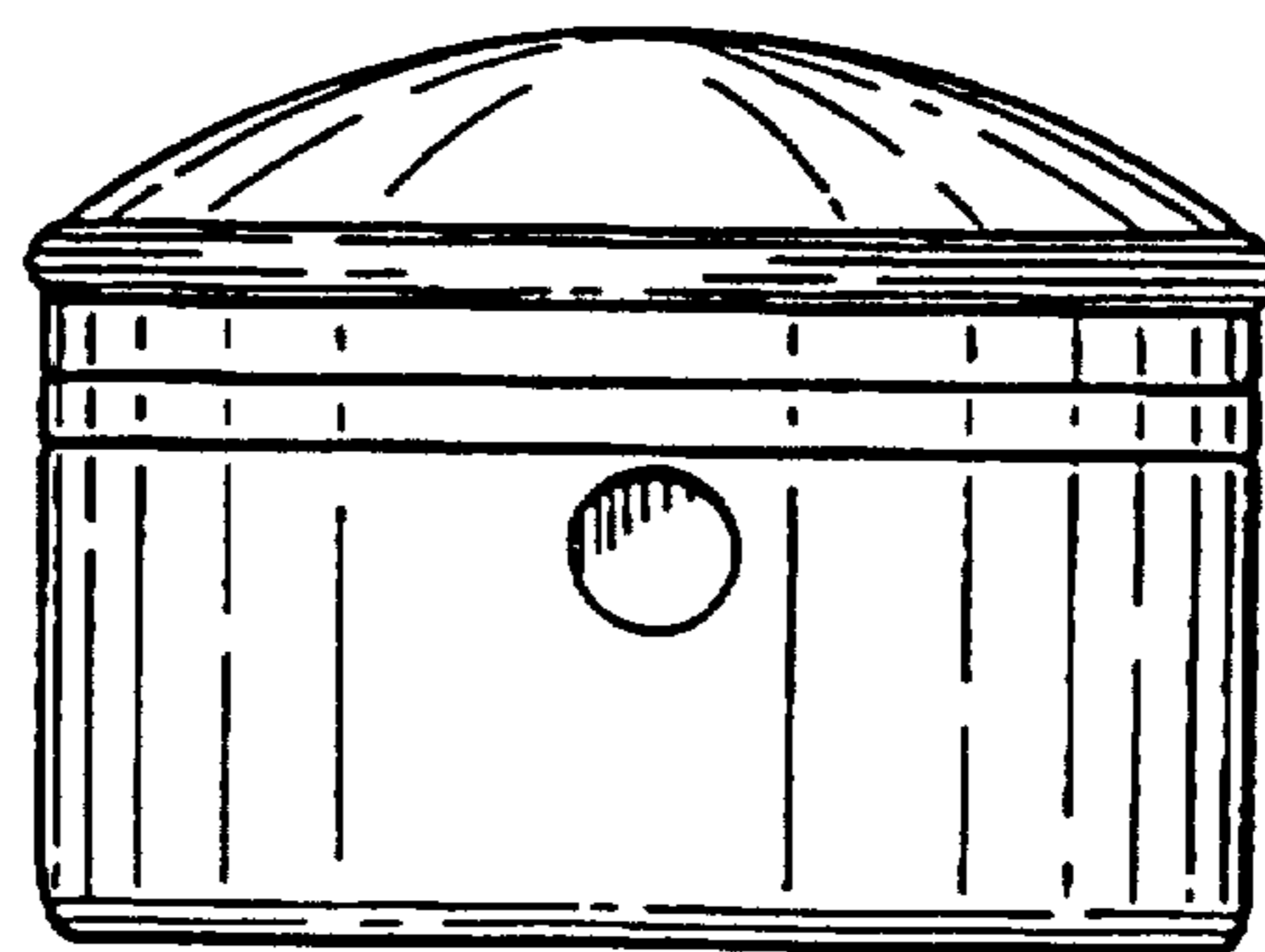

FIG. 4

FIG. 5

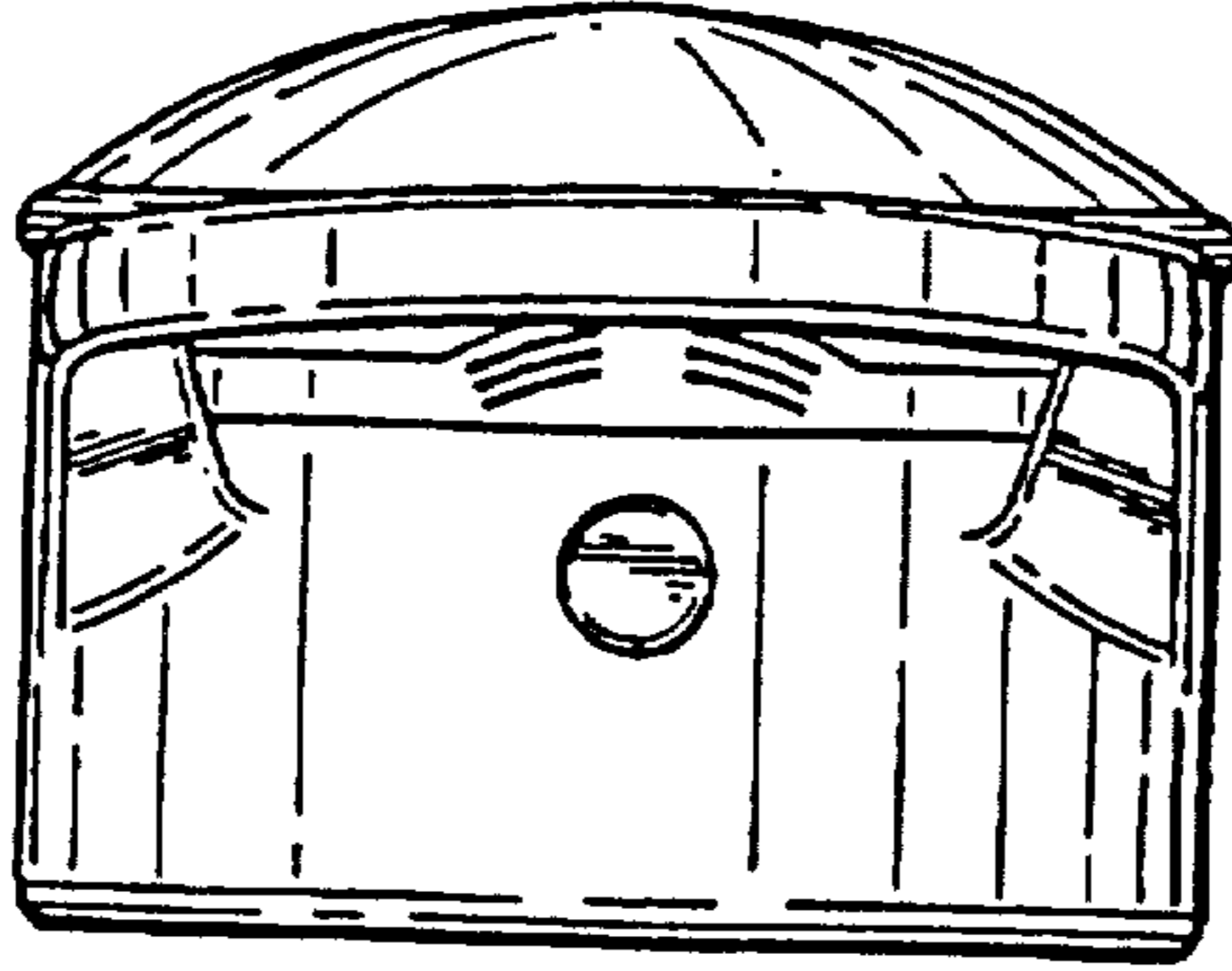

FIG. 6

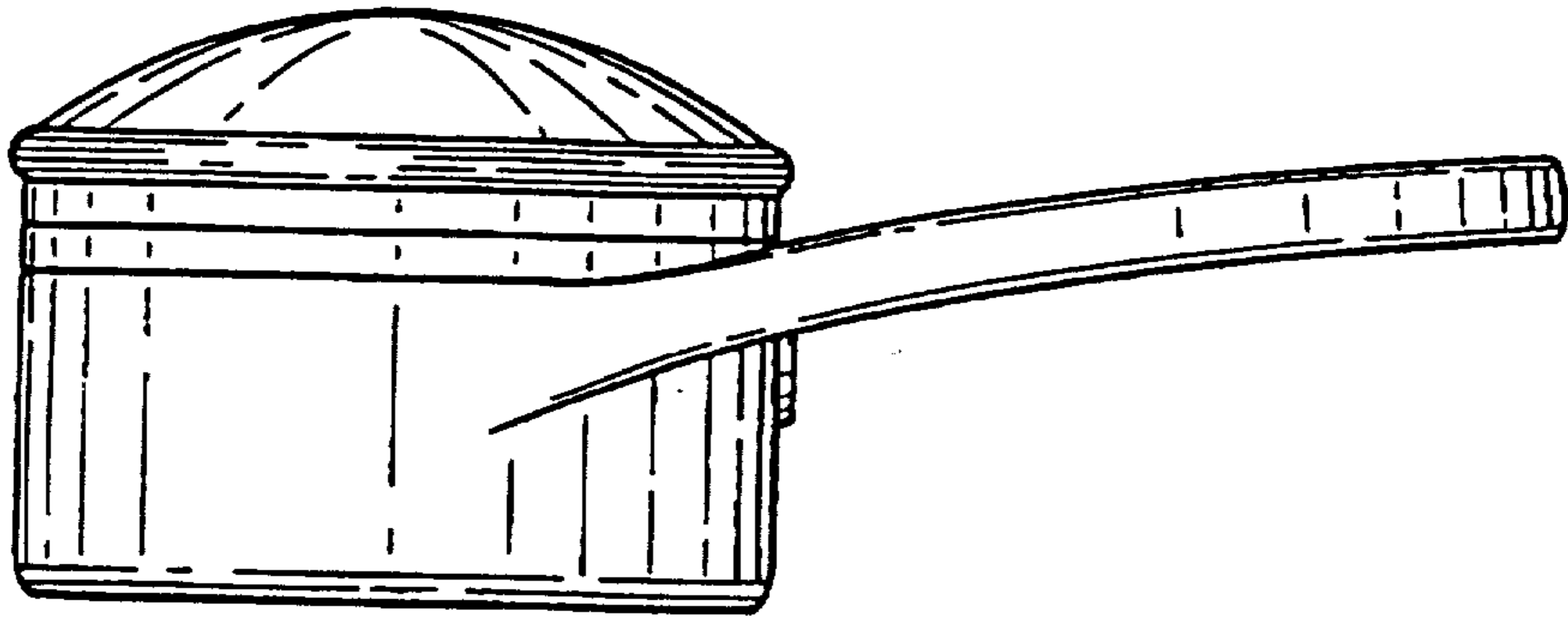

FIG. 7

