



US00D329693S

United States Patent [19] Mills

[11] Patent Number: **Des. 329,693**

[45] Date of Patent: **** Sep. 22, 1992**

[54] **FIREPLACE INSERT**

[75] Inventor: **Bob T. Mills, Victoria, Canada**

[73] Assignee: **Osburn Manufacturing Inc., Victoria, Canada**

[**] Term: **14 Years**

[21] Appl. No.: **354,421**

[22] Filed: **May 18, 1989**

[30] **Foreign Application Priority Data**

Dec. 23, 1988 [CA] Canada 23-12-88-1
 [52] U.S. Cl. **D23/344**
 [58] Field of Search D23/347, 392, 403, 405,
 D23/406, 342, 343, 344, 346, 350; 126/61, 66,
 67, 58

[56] **References Cited**

U.S. PATENT DOCUMENTS

D. 115,048 5/1939 Morgan D23/343
 D. 277,129 1/1985 Larson et al. D23/350
 D. 283,343 4/1986 Haythornthwaite D23/344
 D. 289,195 4/1987 De Sautels D23/343
 D. 299,527 1/1989 Henry D23/344
 4,213,443 7/1980 Morande, Jr. 126/61
 4,361,131 11/1982 Homolik 126/61

OTHER PUBLICATIONS

KNT Division Perfection Mfg. Corp. Adv. Brochure, p. 2, Fireplace inserts **(A)** **(B)** **(C)**, top, middle right, and bottom right sides of page respectively.

National Stove Works, Inc. Adv. Flyer, front side of flyer, showplace stove, middle left side of page. Majestic Co. Adv. Brochure, back cover, Fireplace inserts Models 1200, 1500, and 2200, top of page.

Primary Examiner—Wallace R. Burke
Assistant Examiner—Lisa Lichtenstein
Attorney, Agent, or Firm—Eckert Seamans Cherin & Mellott

[57] **CLAIM**

The ornamental design for a fireplace insert, as shown and described.

DESCRIPTION

FIG. 1 is a front, right side perspective view of a fireplace insert showing my new design;
 FIG. 2 is an enlarged front elevation view thereof;
 FIG. 3 is an enlarged right side elevation view thereof;
 FIG. 4 is an enlarged top plan view thereof;
 FIG. 5 is a front, right side perspective view of a fireplace insert showing a second embodiment of my new design;
 FIG. 6 is an enlarged front elevation view of FIG. 5;
 FIG. 7 is an enlarged right side elevation view of FIG. 5, the left side being a mirror image of that shown;
 FIG. 8 is an enlarged top plan view of FIG. 5;
 FIG. 9 is a front, right side perspective view of a fireplace insert showing a third embodiment of my new design;
 FIG. 10 is an enlarged front elevation view of FIG. 9;
 FIG. 11 is an enlarged right side elevation view of FIG. 9, the left side being a mirror image of that shown; and
 FIG. 12 is an enlarged top plan view of FIG. 9.

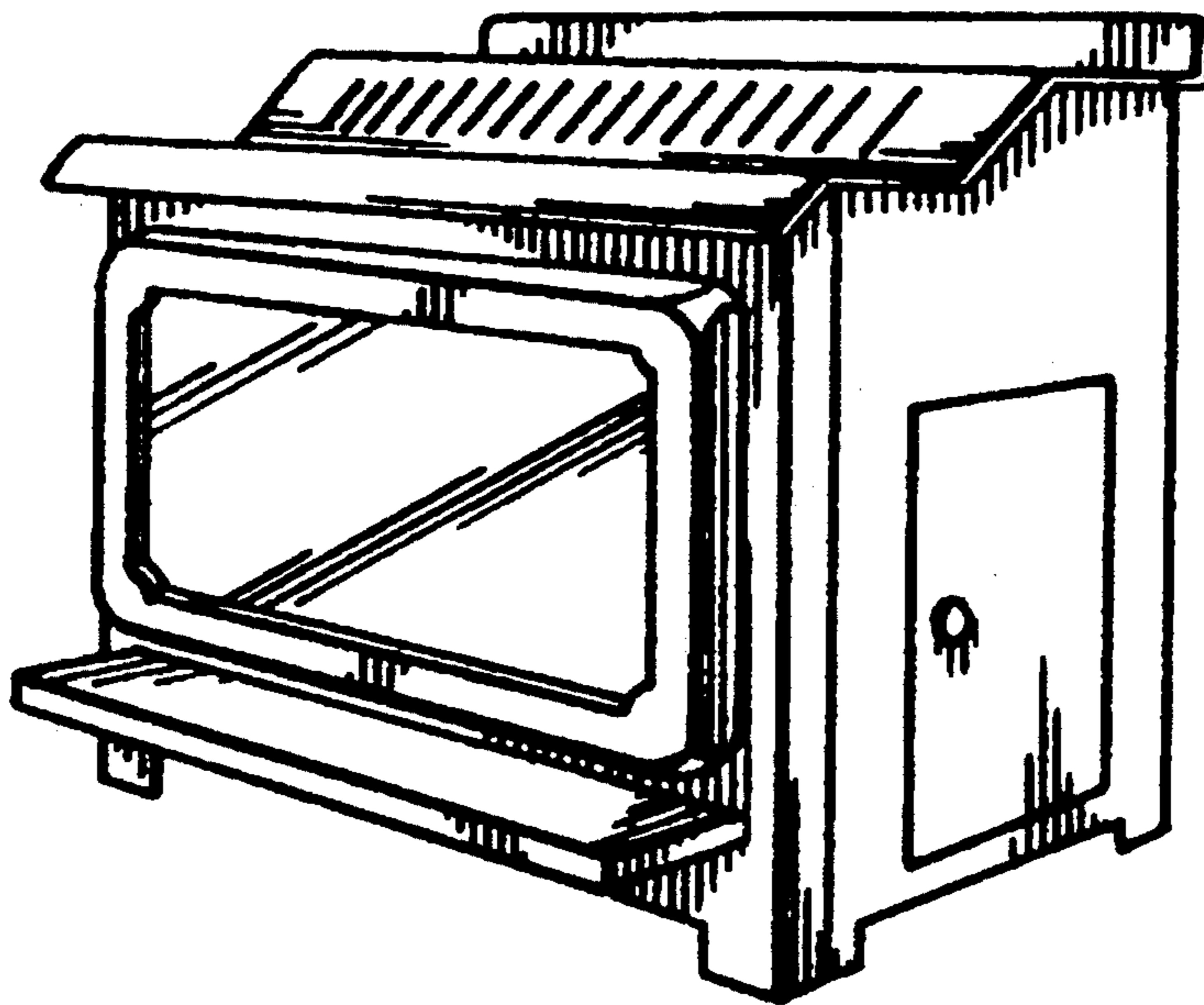

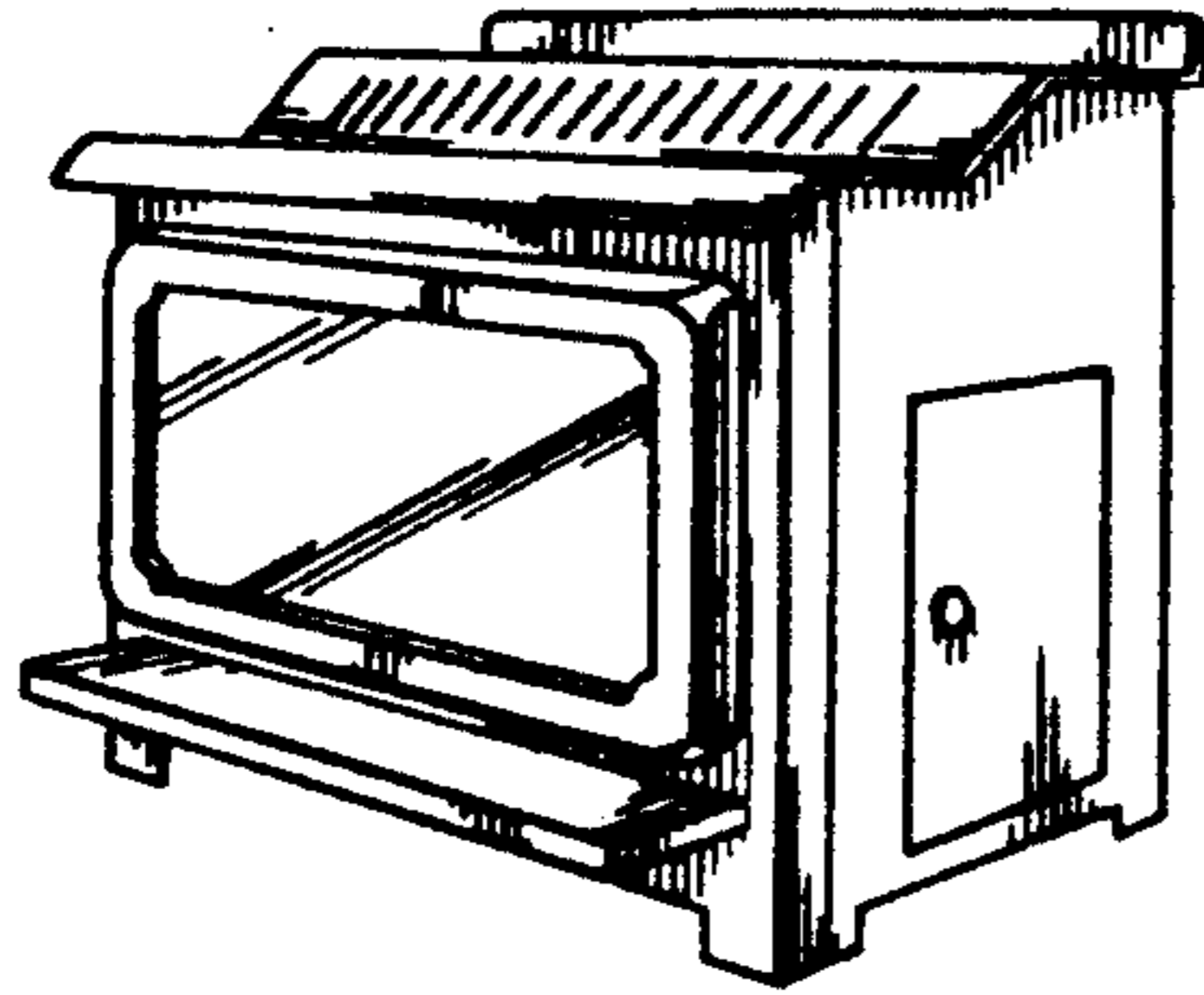

FIG. 1

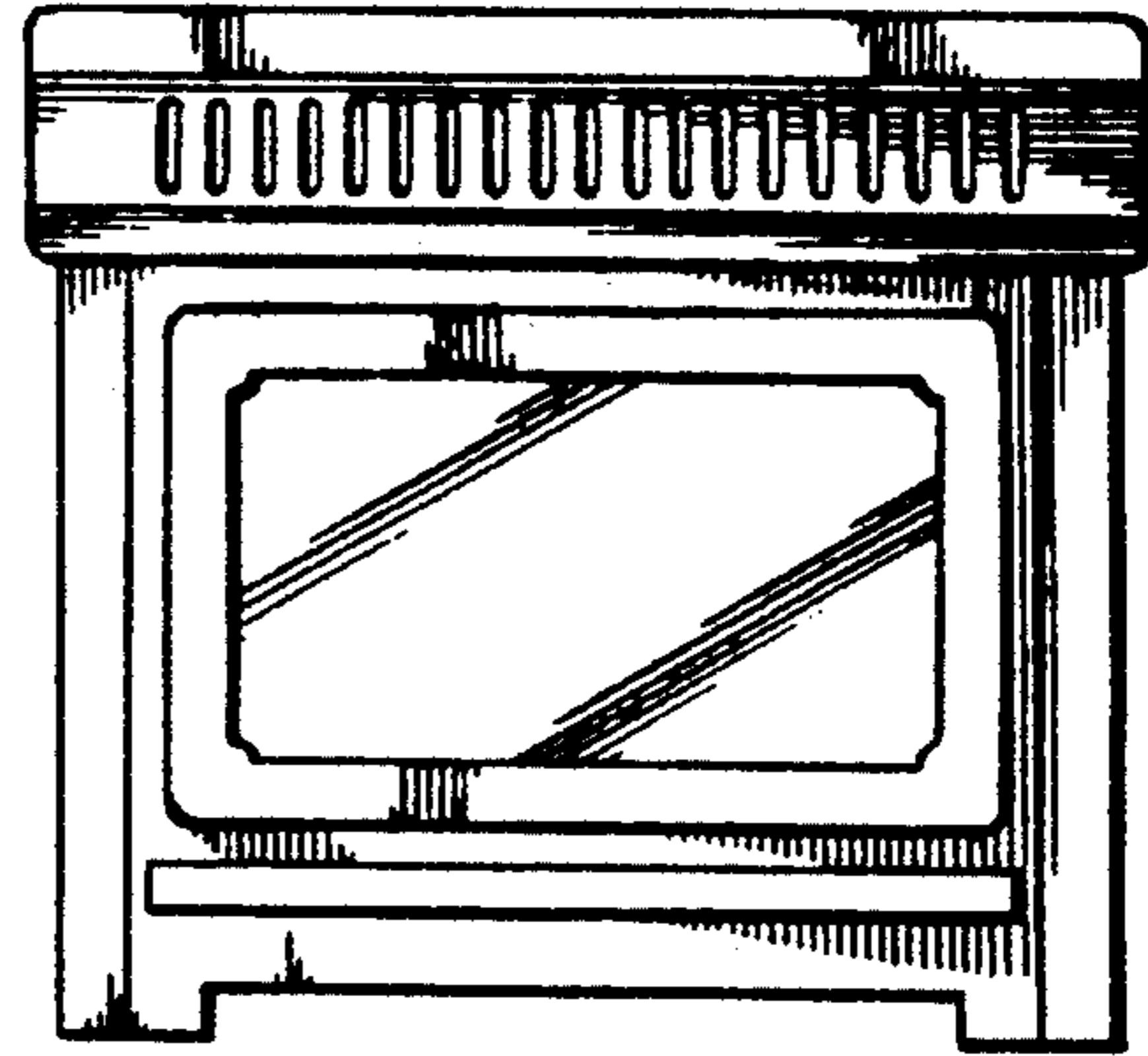

FIG. 2

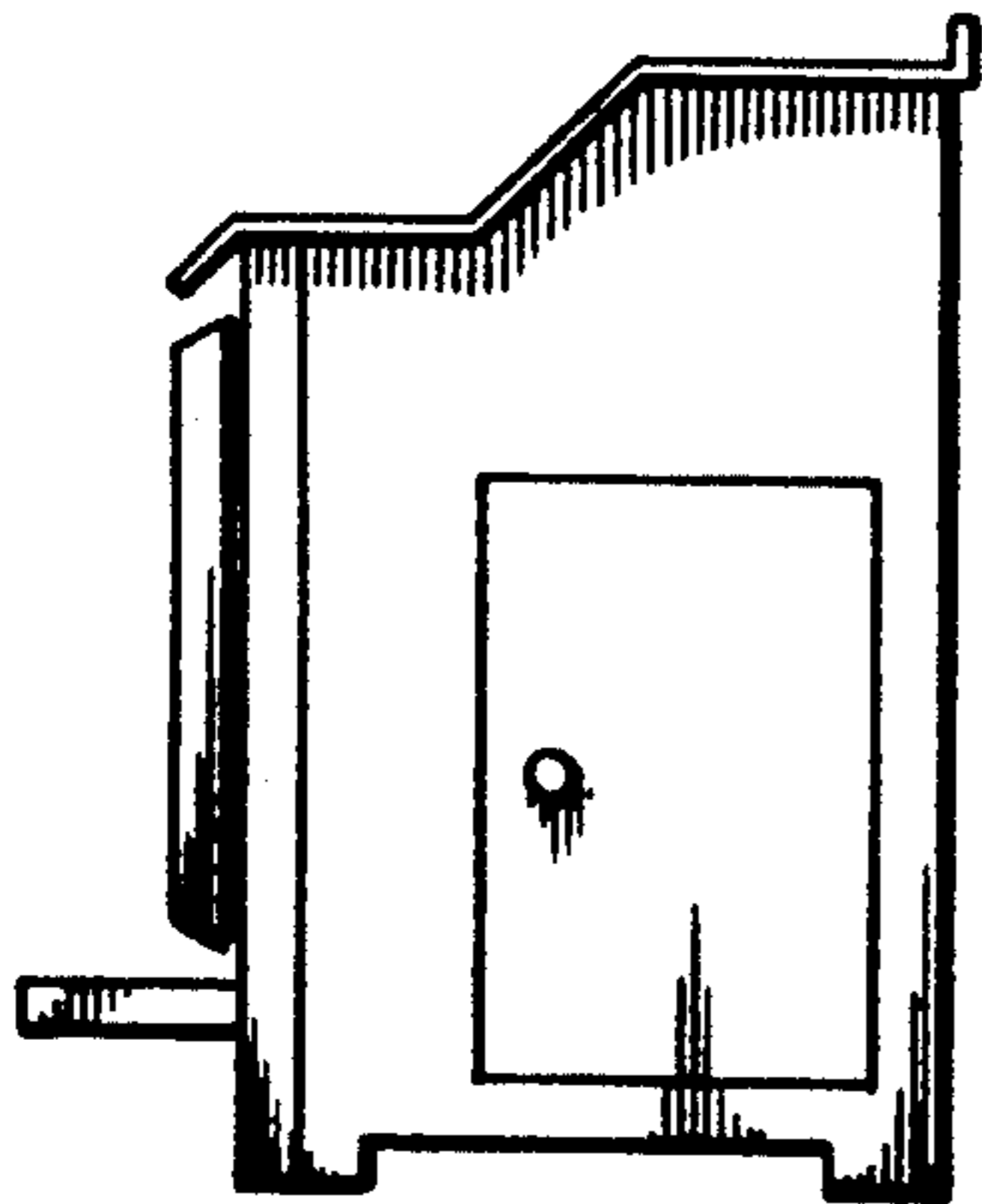

FIG. 3

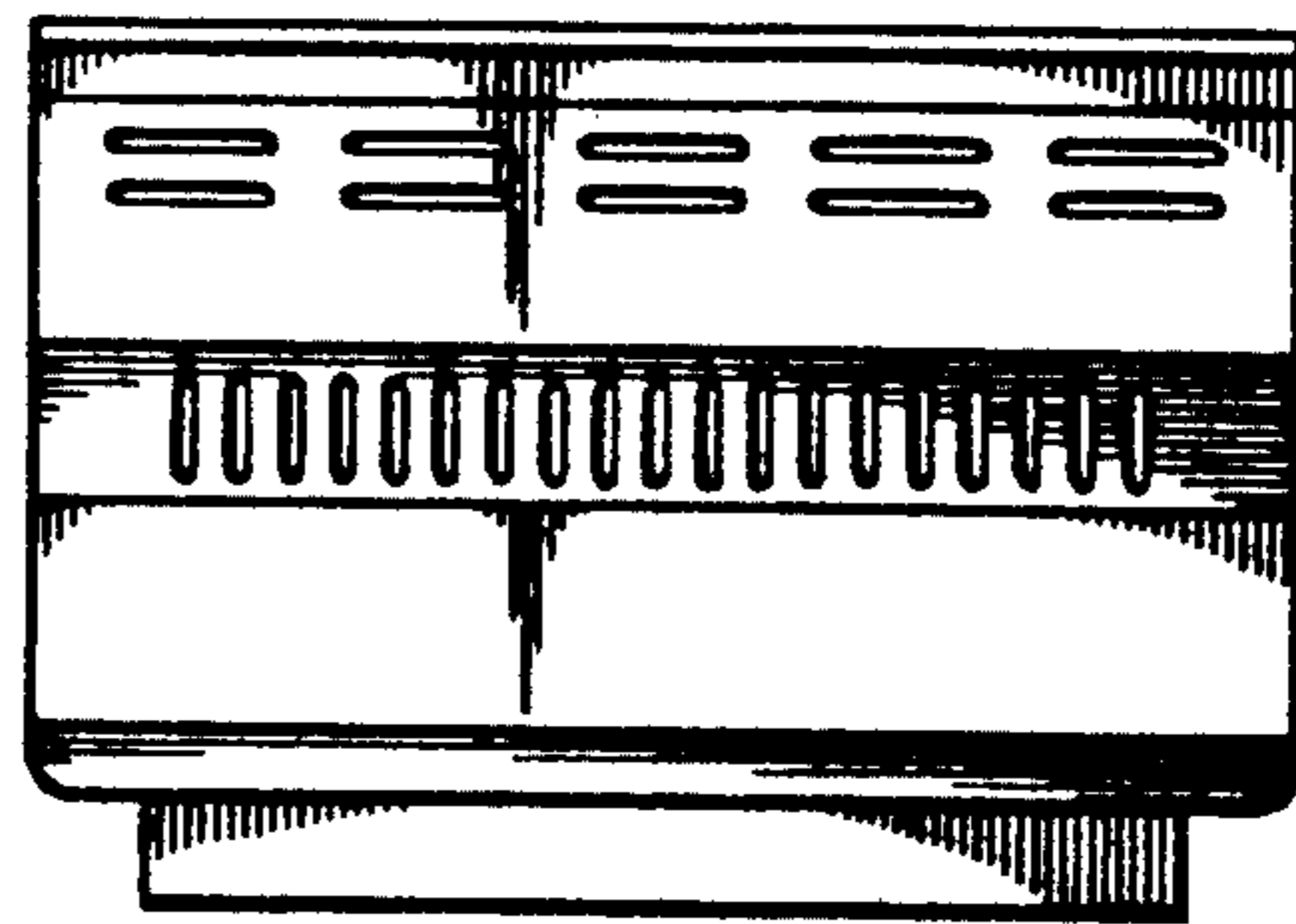

FIG. 4

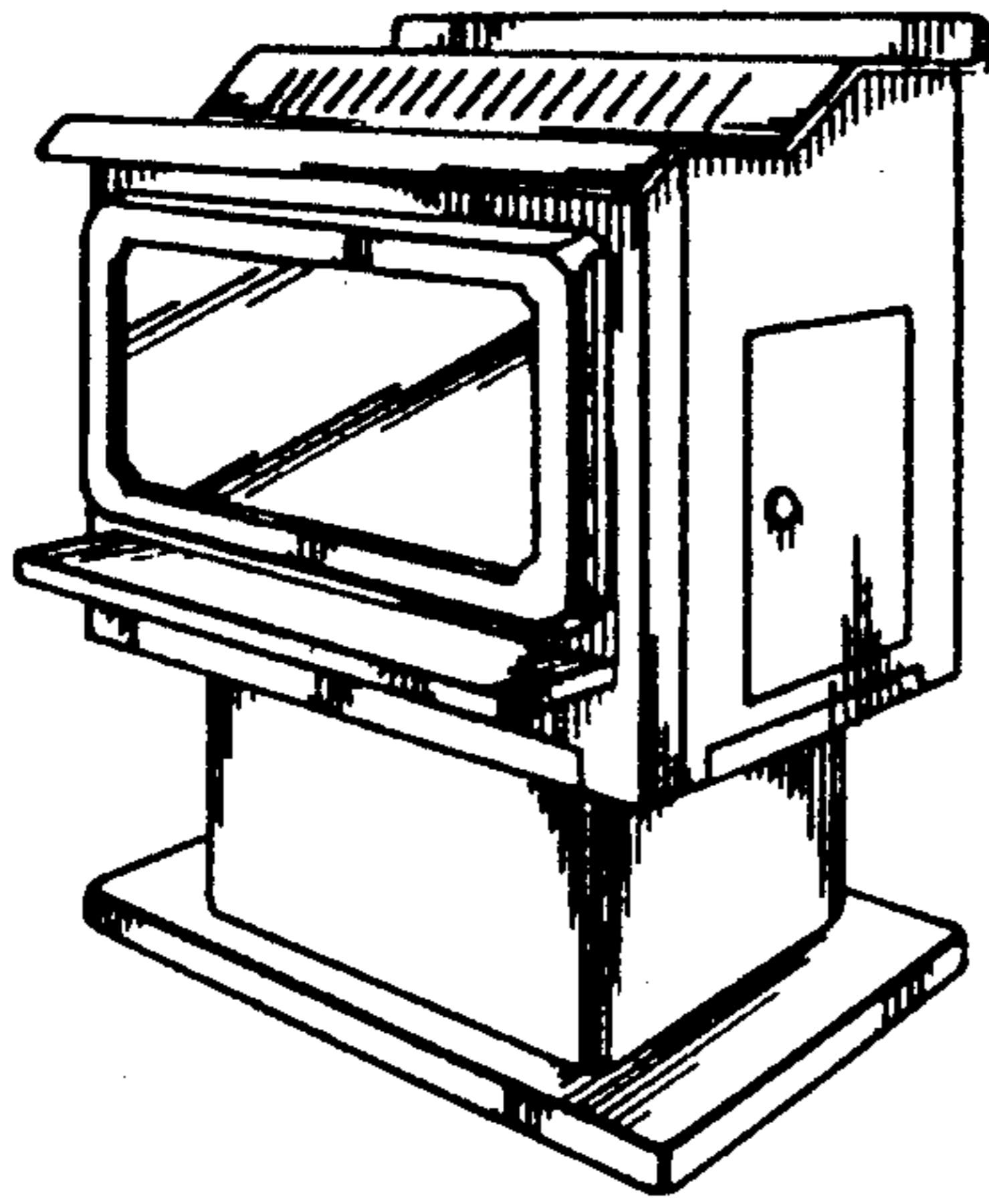

FIG. 5

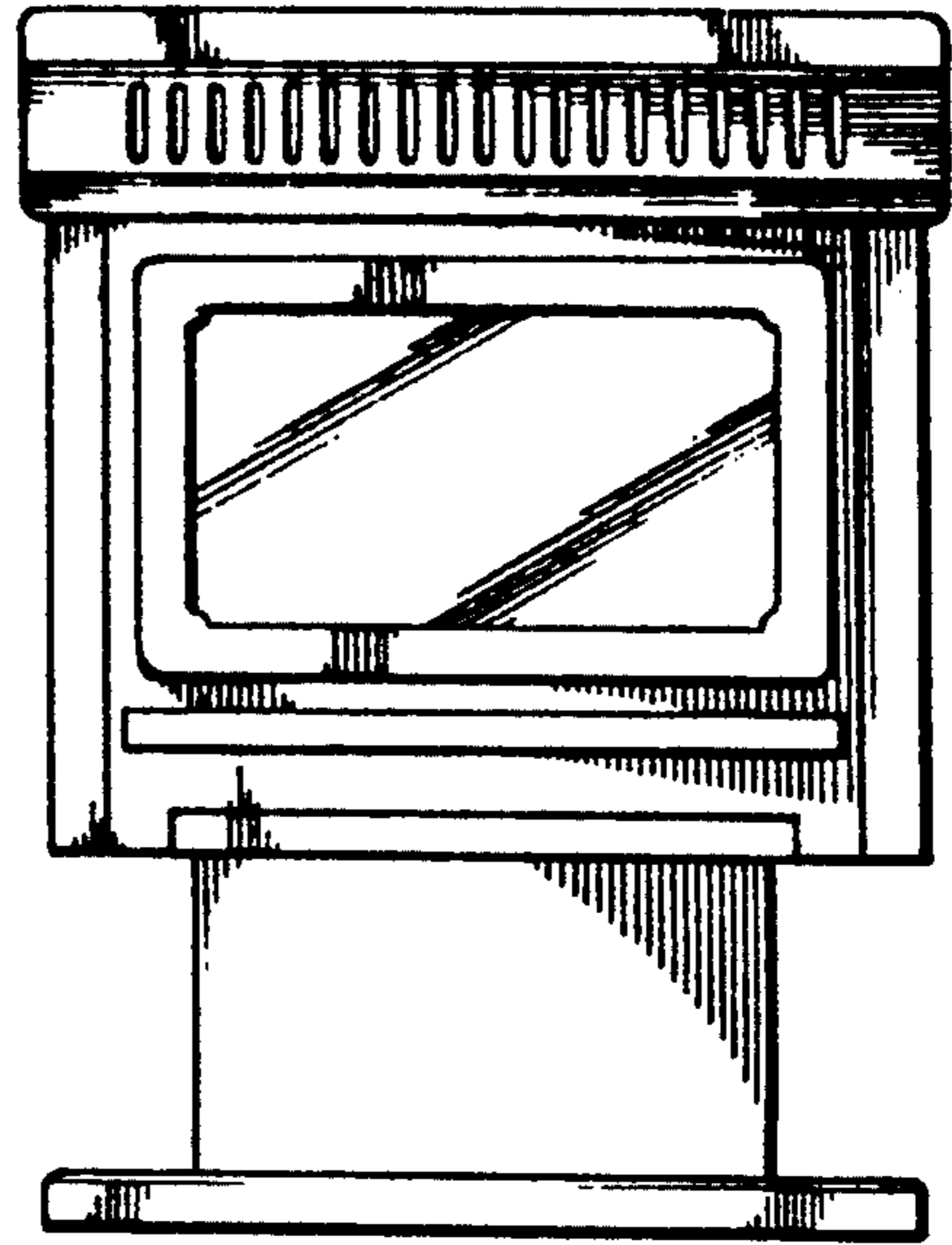

FIG. 6

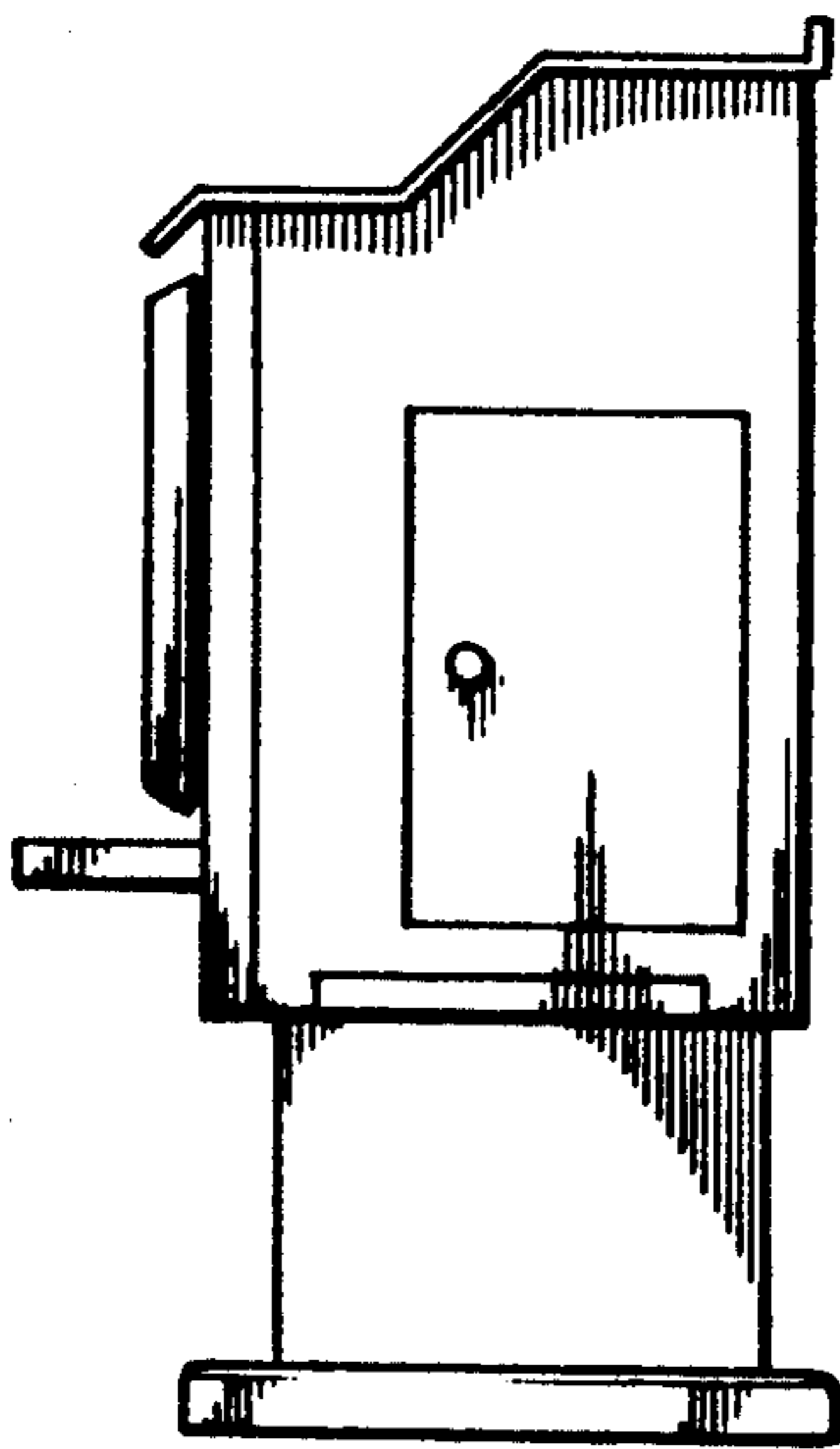

FIG. 7

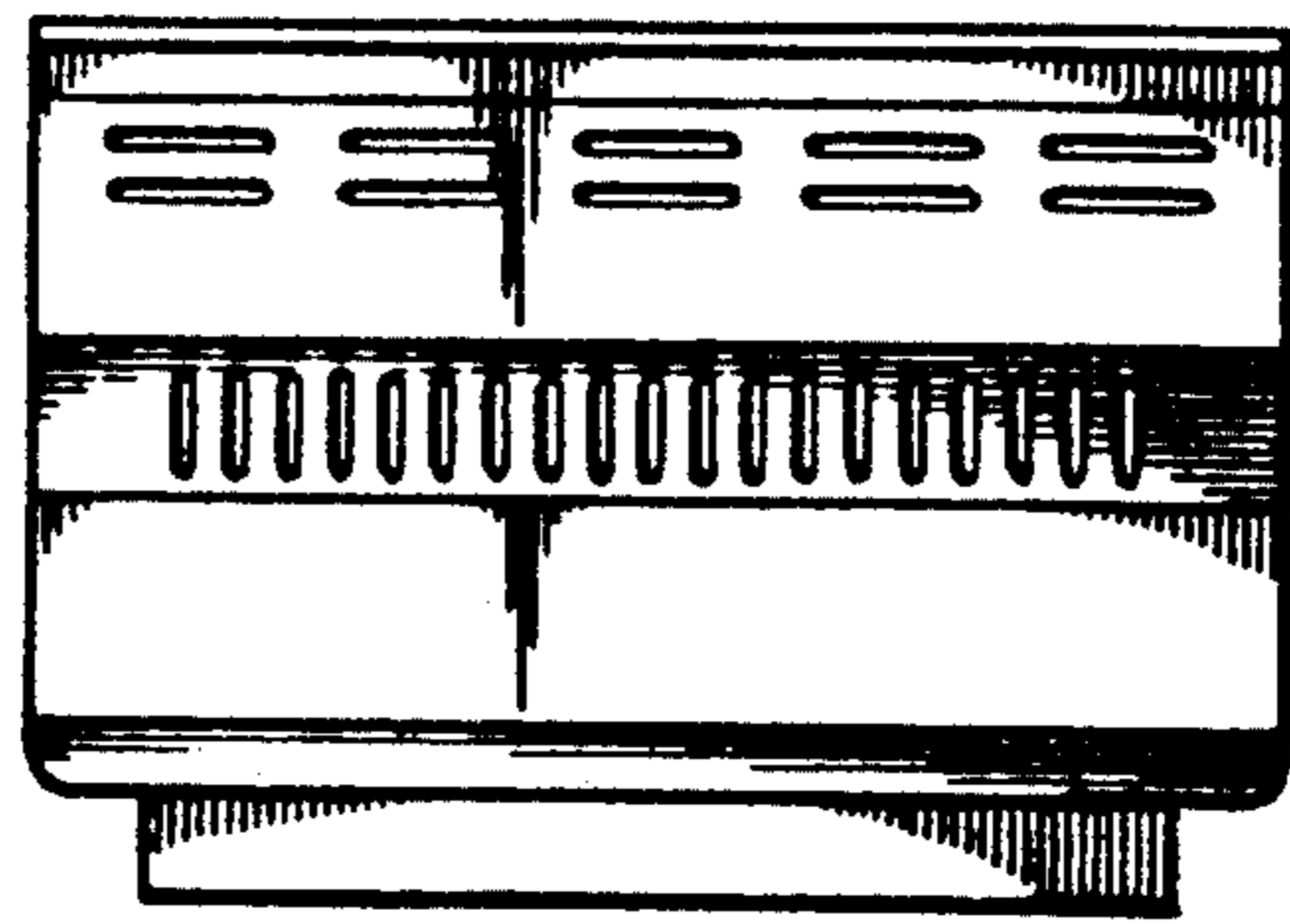

FIG. 8

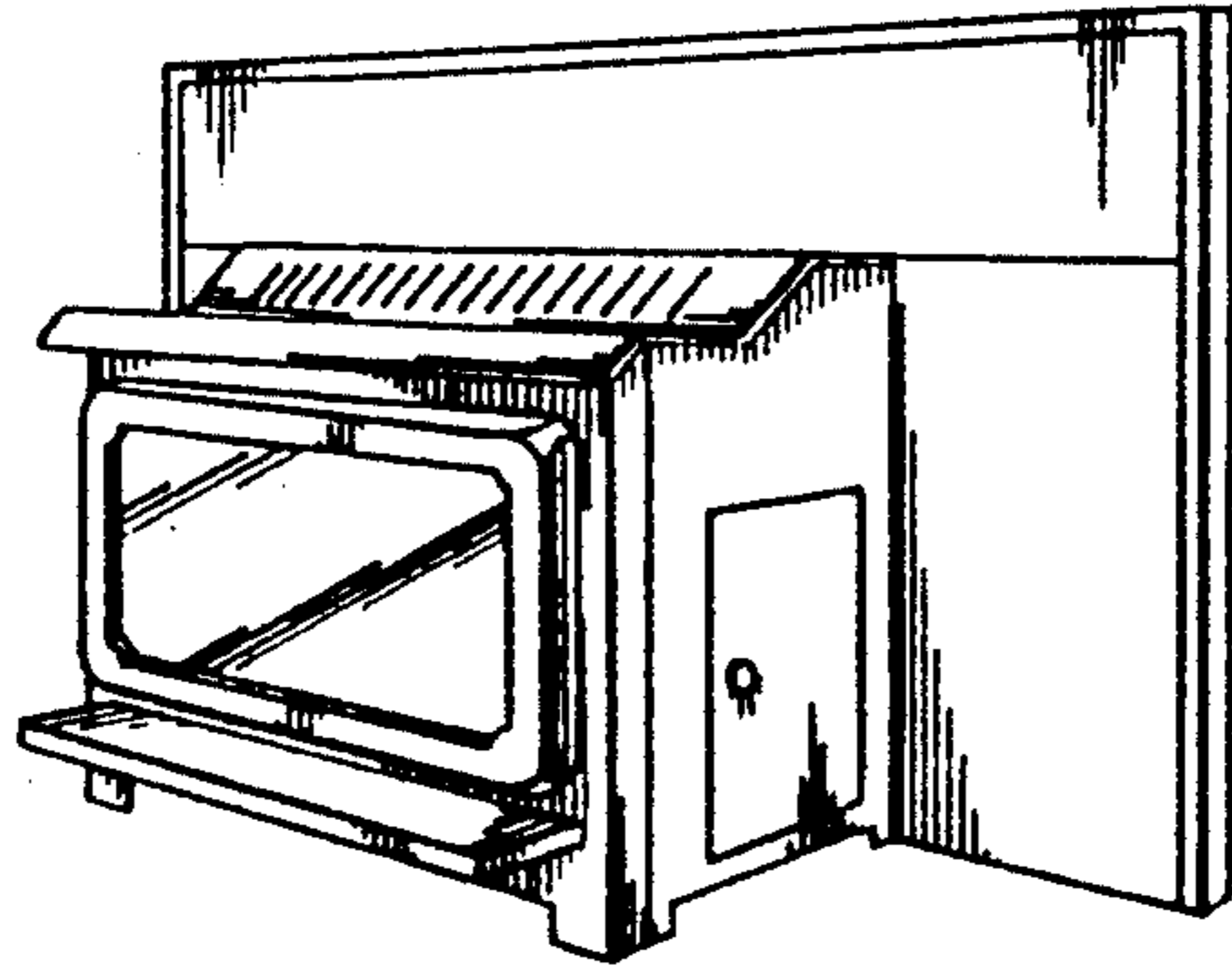

FIG. 9

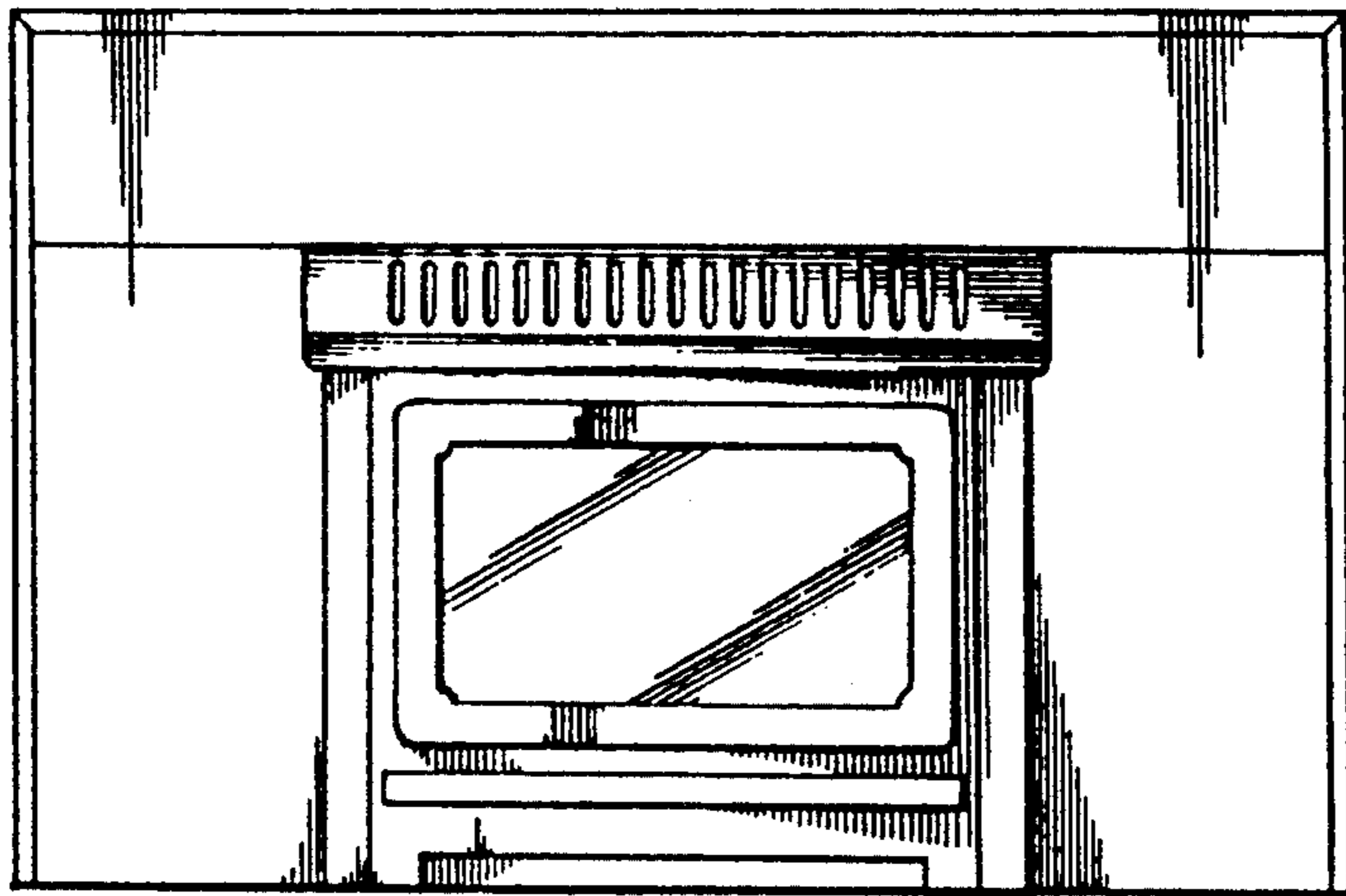

FIG. 10

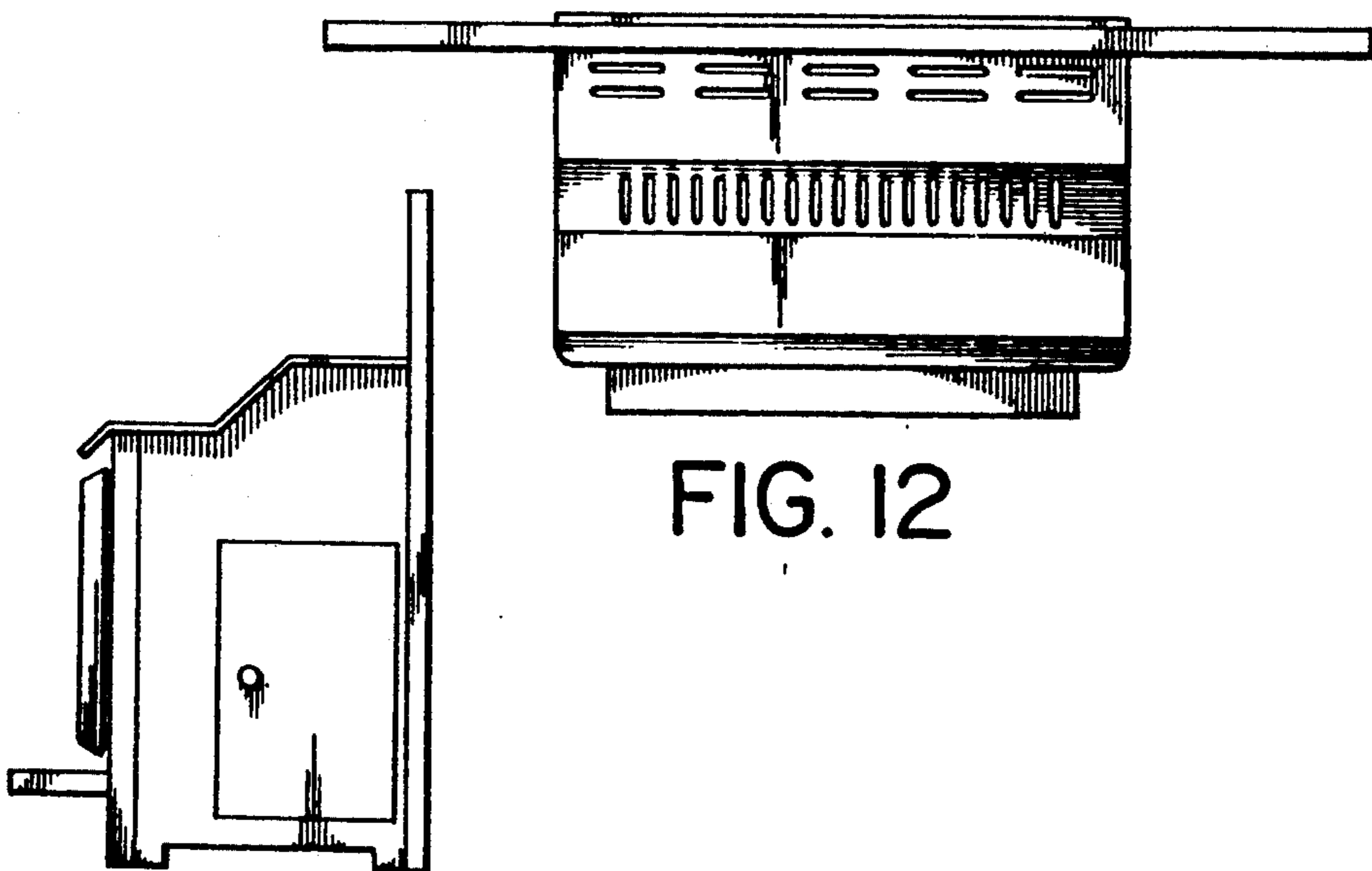

FIG. 11

FIG. 12