



US00D329588S

United States Patent [19]

[11] Patent Number: **Des. 329,588**

Michel, Jr.

[45] Date of Patent: **** Sep. 22, 1992**

[54] **CORD CLIP**

[75] Inventor: **Richard E. Michel, Jr., Dover, Ohio**

[73] Assignee: **Miller Products, Inc., New Philadelphia, Ohio**

[**] Term: **14 Years**

[21] Appl. No.: **551,848**

[22] Filed: **Jul. 12, 1990**

[52] U.S. Cl. **D8/395**

[58] Field of Search **D8/349, 354, 382, 383, D8/394, 395; 24/129 R, 129 B, 531, 555, 563; 248/67.5, 74.4, 74.5, 205.3**

[56] **References Cited**

U.S. PATENT DOCUMENTS

D. 295,194	4/1988	McCormick	D8/395
D. 319,903	9/1991	Barner	D8/395
3,363,290	1/1968	Camenisch	24/531
3,632,071	1/1972	Cameron	248/205.3
3,659,319	5/1972	Erickson	248/205.3
4,125,243	11/1978	Liptak	248/205.3
4,614,321	9/1986	Andre	24/555
4,646,394	3/1987	Krauss	24/563
4,962,907	10/1990	Gary	248/205.3

OTHER PUBLICATIONS

American International Marine Corporation 1980, p. 47, Cleet, bottom.

"Self-Adhesive Nylon Clips", The American Design Team, St. Charles, Ill., undated.

"Self-Adhesive Klik Klip Wire Klip", Super Glue Corporation, Hollis, N.Y., undated.

"Self-Adhesive Super Klip", Super Glue Corp., Ridge-wood, N.Y., undated.

"Stick on Electrical Lead Clip", Australian Sales Stick-On Products, undated.

Primary Examiner—Bernard Ansher

Assistant Examiner—Sandra Morris

Attorney, Agent, or Firm—Michael Sand Co.

[57] **CLAIM**

The ornamental design for a cord clip, as shown and described.

DESCRIPTION

FIG. 1 is a perspective view of a cord clip, showing my new design, the cord shown in broken lines is for illustrative purposes only, and forms no part of the claimed design;

FIG. 2 is an enlarged top perspective view thereof;

FIG. 3 is an enlarged top plan view thereof;

FIG. 4 is an enlarged side elevational view thereof, the other side being identical;

FIG. 5 is an enlarged front end elevational view thereof;

FIG. 6 is an enlarged back end elevational view thereof; and,

FIG. 7 is an enlarged bottom plan view thereof.

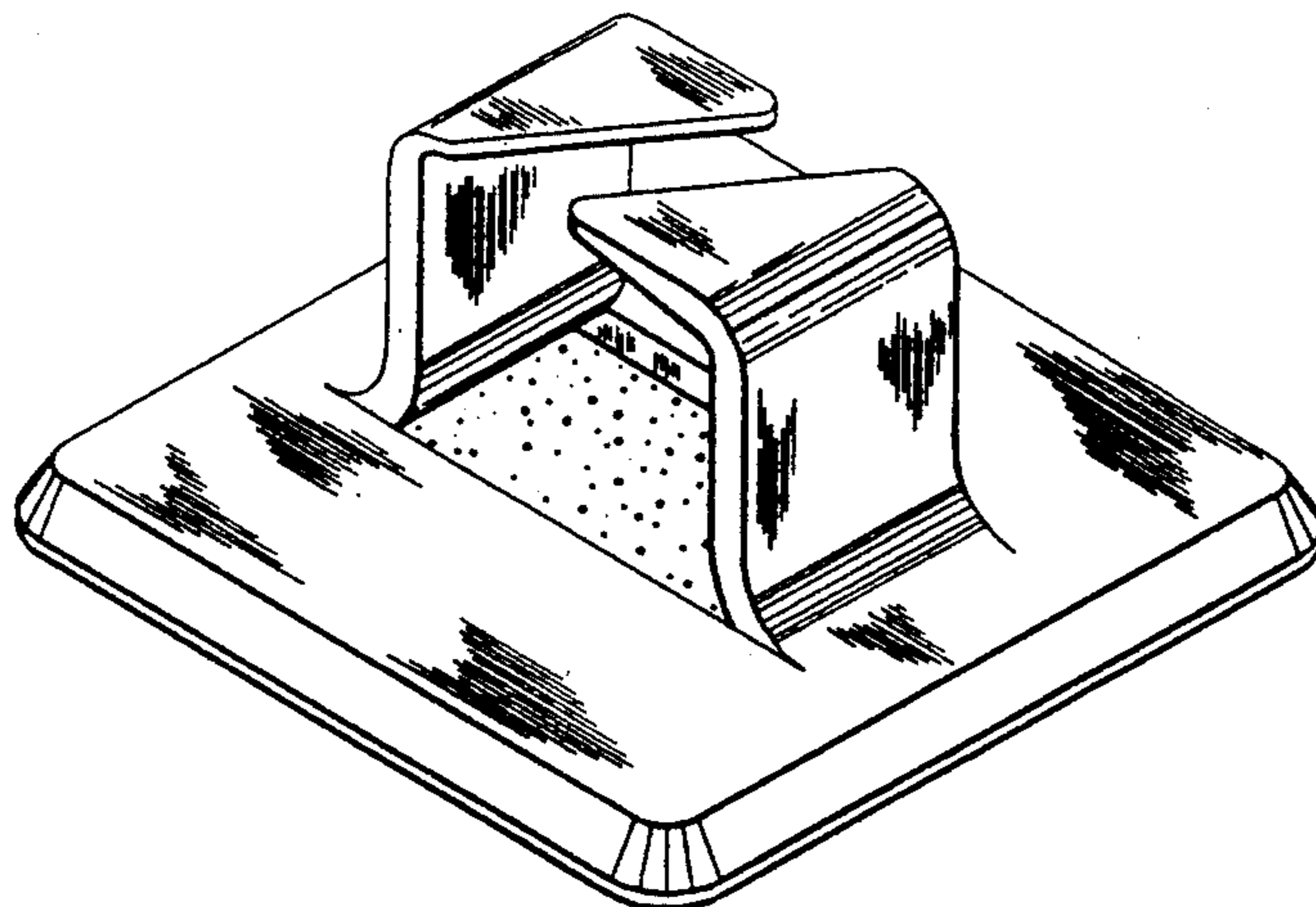

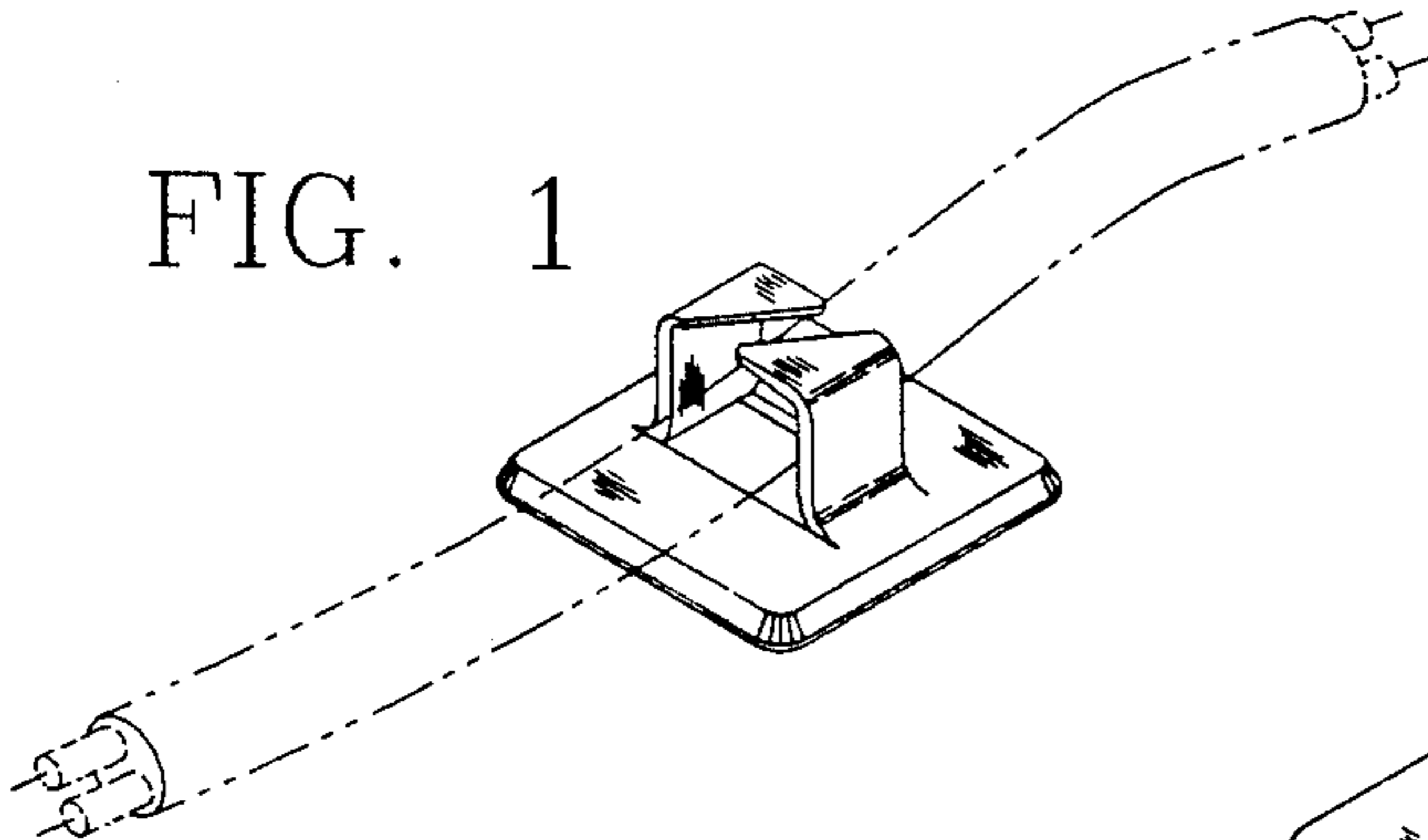

FIG. 1

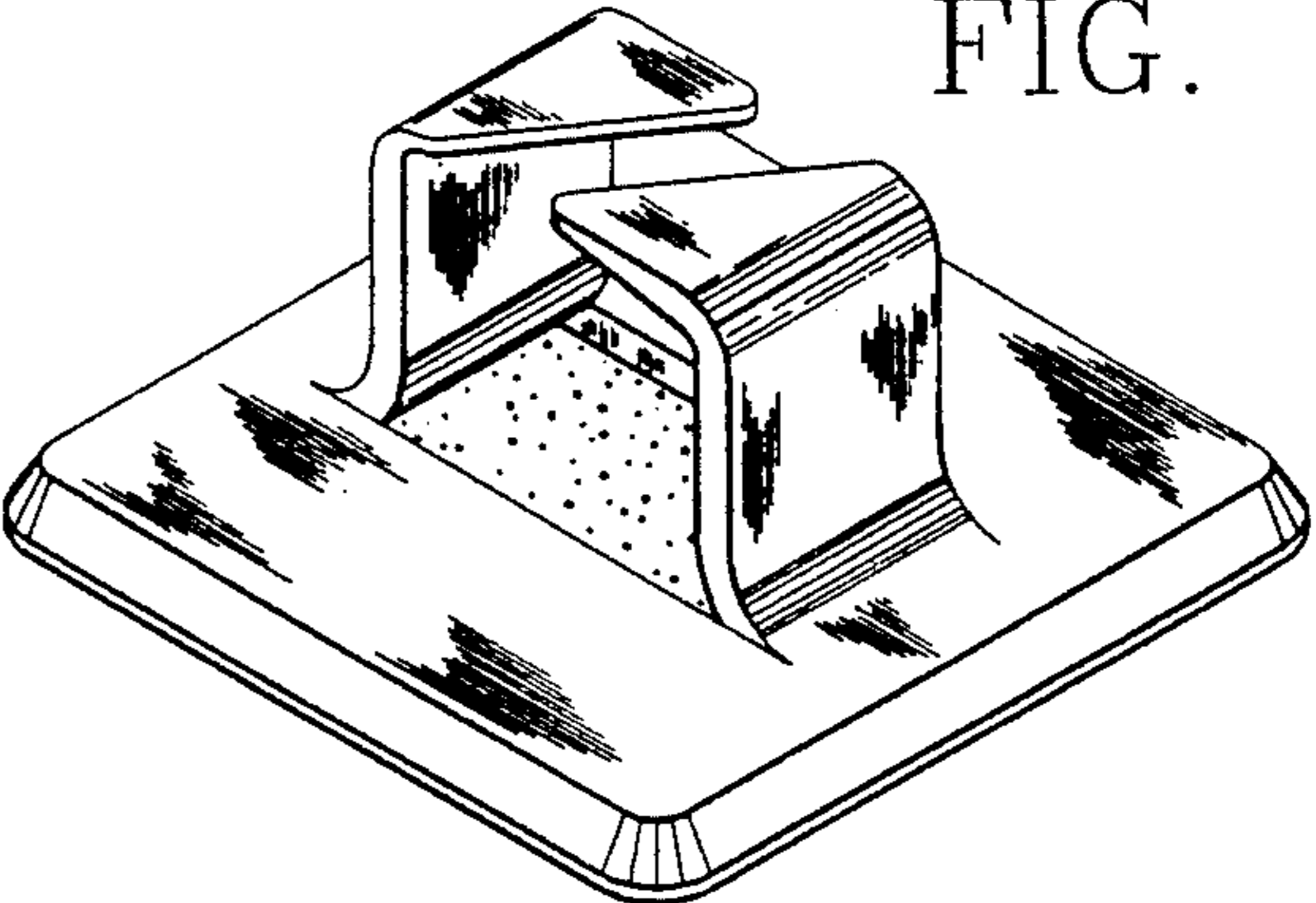

FIG. 2

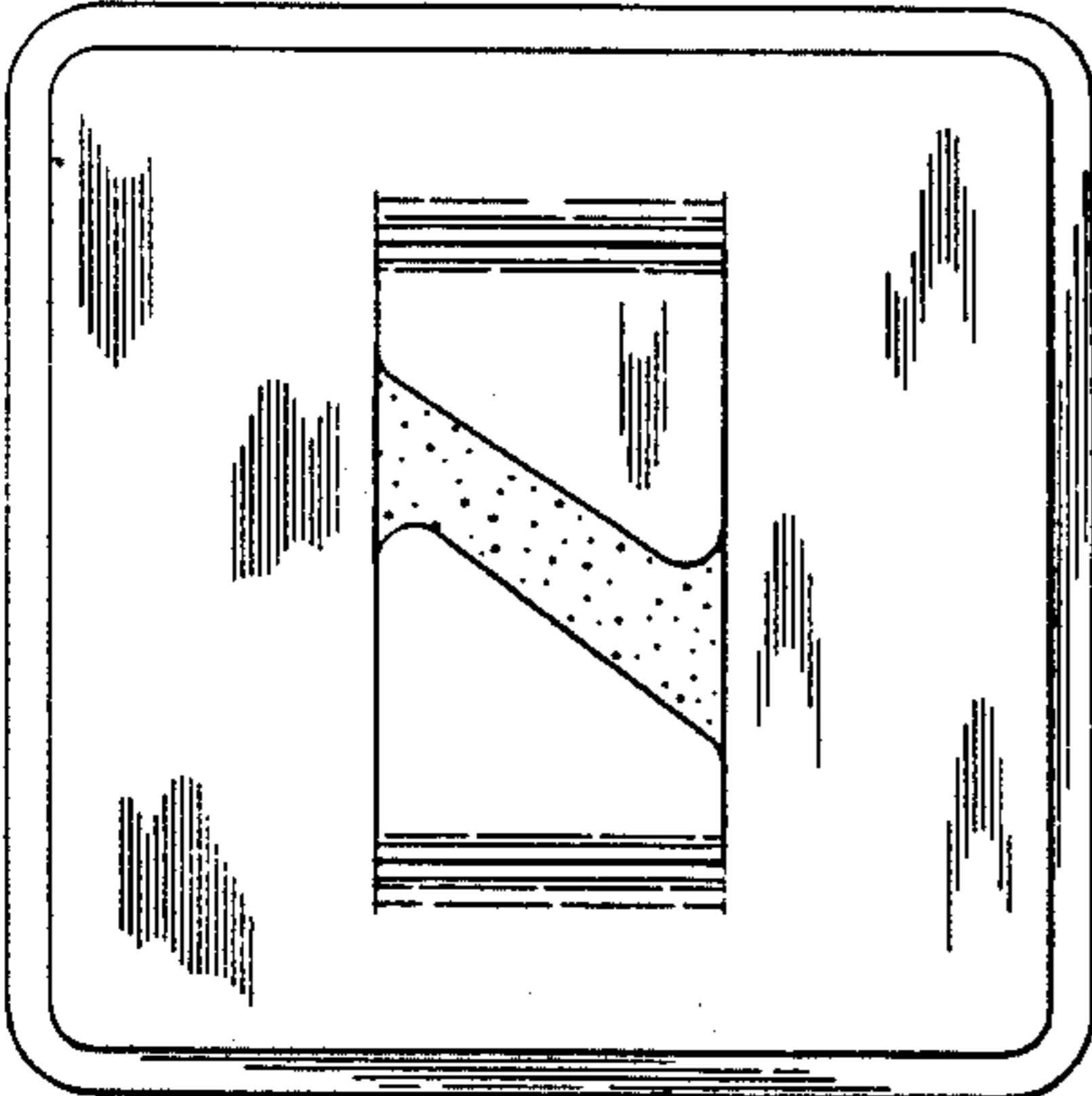

FIG. 3

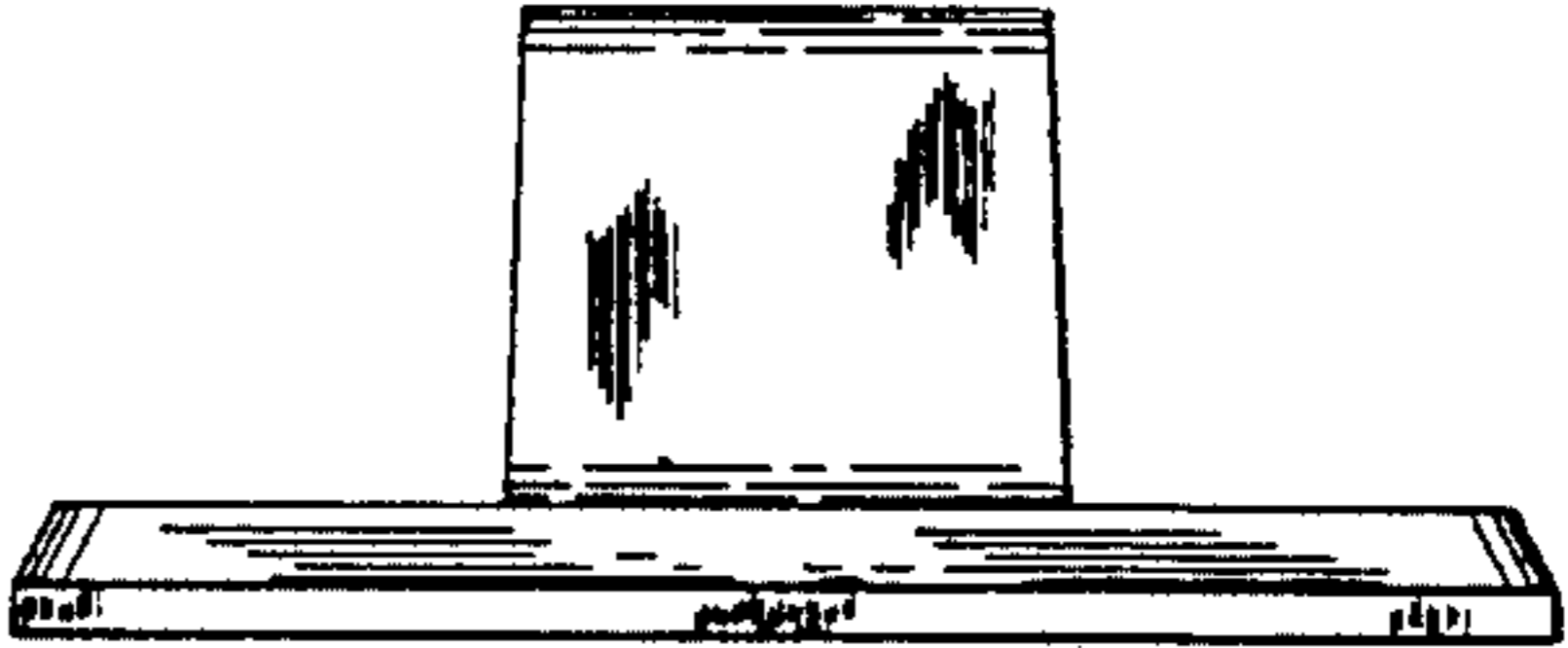

FIG. 4

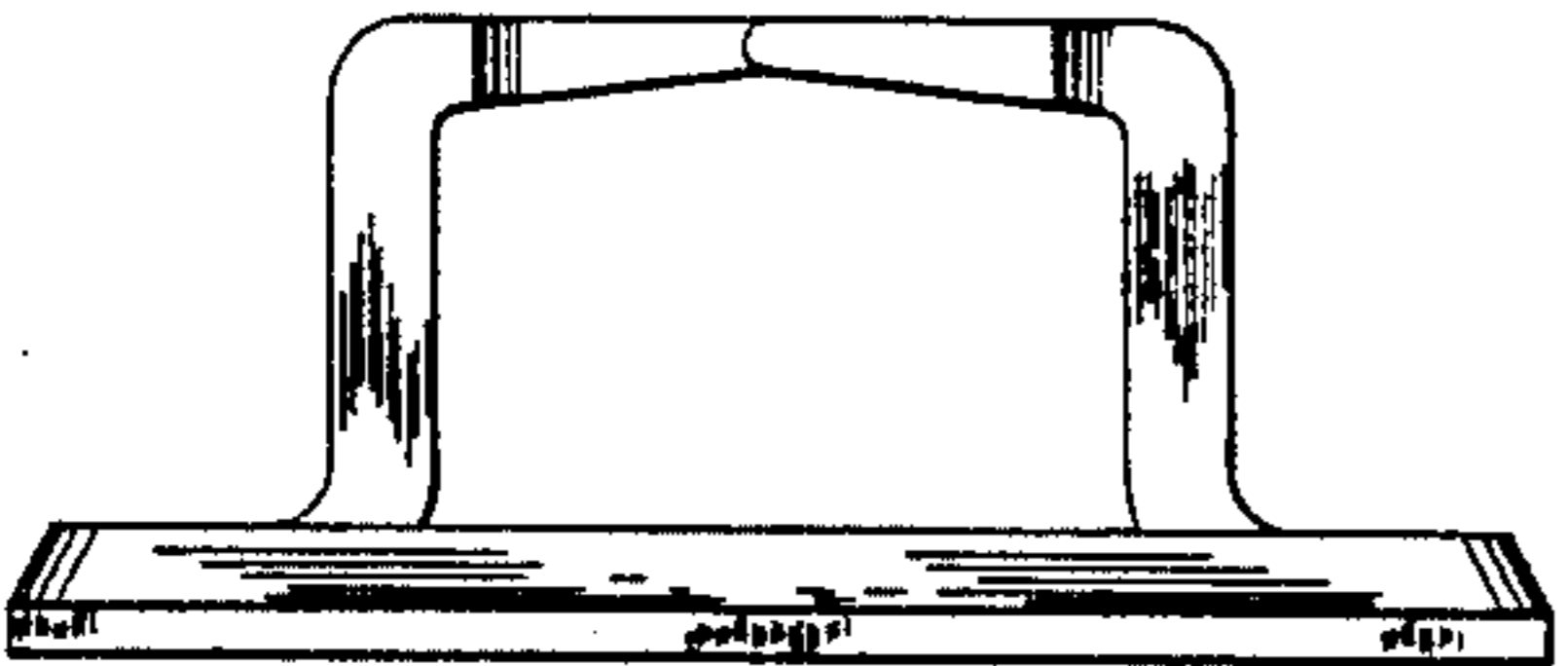

FIG. 6

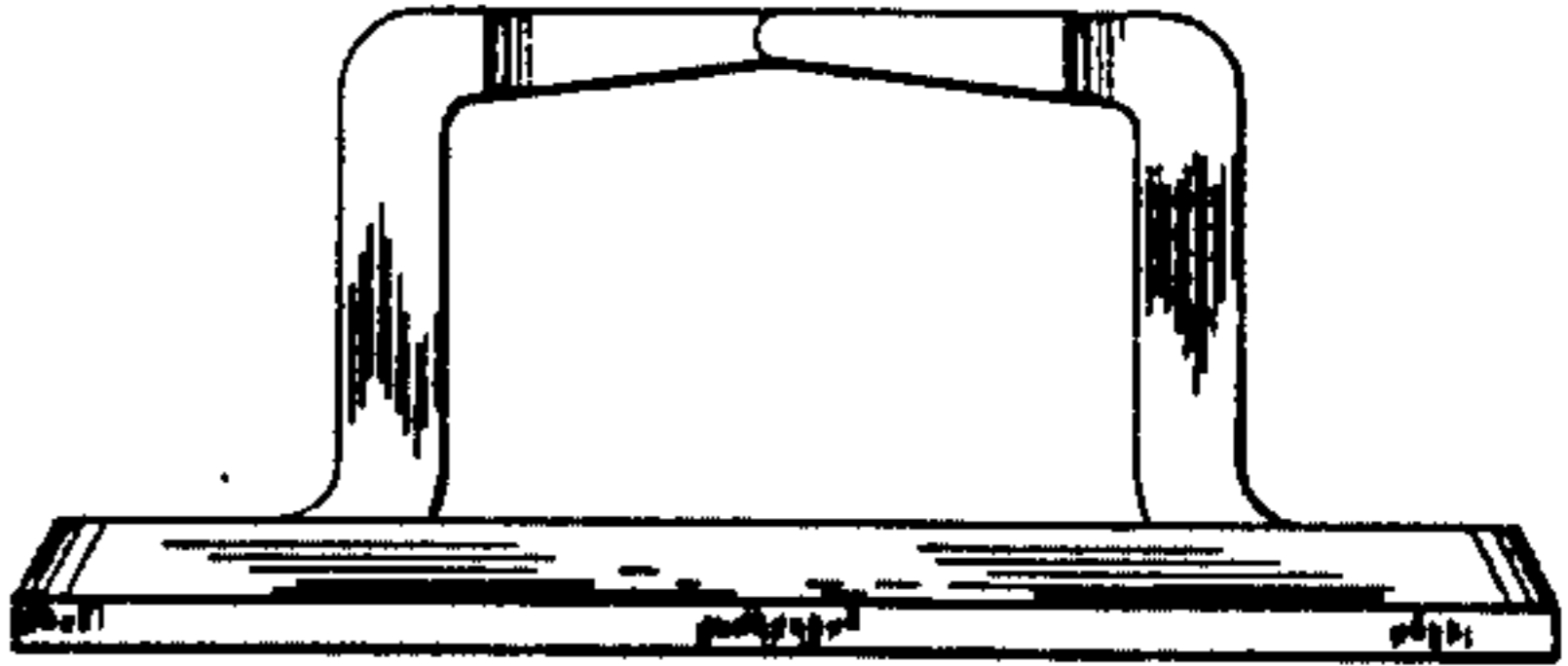

FIG. 5

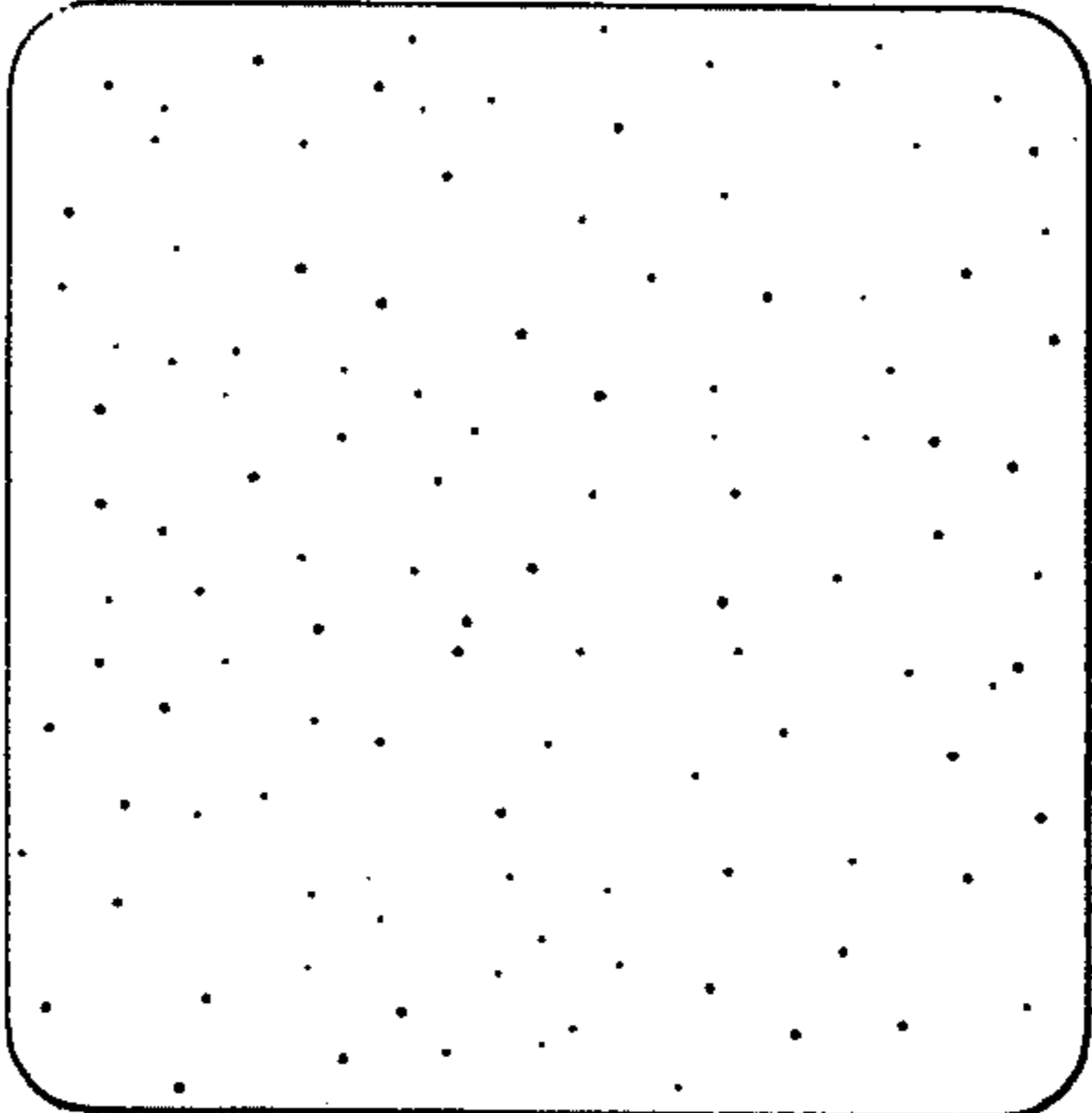

FIG. 7