



US00D329543S

# United States Patent [19]

[11] Patent Number: **Des. 329,543**

Shields

[45] Date of Patent: **\*\* Sep. 22, 1992**

## [54] SEAT

## DESCRIPTION

- [75] Inventor: **Michael R. Shields**, Greensboro, N.C.
- [73] Assignee: **Brayton International Collection**, High Point, N.C.
- [\*\*] Term: **14 Years**
- [21] Appl. No.: **724,949**
- [22] Filed: **Jul. 2, 1991**
- [52] U.S. Cl. .... **D6/334; D6/381**
- [58] Field of Search ..... **D6/334, 371, 381, 500**

FIG. 1 is a right-front perspective view of a seat showing my new design;  
 FIG. 2 is a right-rear perspective view;  
 FIG. 3 is a right side elevational view, the left side being a mirror image thereof;  
 FIG. 4 is a top plan view;  
 FIG. 5 is a right-front perspective view of a seat showing a second embodiment of my new design;  
 FIG. 6 is a right-rear perspective view of FIG. 5;  
 FIG. 7 is a right side elevational view of FIG. 5, the left side being a mirror image thereof;  
 FIG. 8 is a front perspective view of a seat showing a third embodiment of my new design;  
 FIG. 9 is a rear elevational view thereof;  
 FIG. 10 is a front perspective view of a seat showing a fourth embodiment of my new design;  
 FIG. 11 is a rear elevational view thereof;  
 FIG. 12 is a front perspective view of a seat showing a fifth embodiment of my new design;  
 FIG. 13 is a rear elevational view thereof;  
 FIG. 14 is a front perspective view of a seat showing a sixth embodiment of my new design;  
 FIG. 15 is a rear elevational view thereof;  
 FIG. 16 is a right-front perspective view of a seat showing my new design of FIG. 14 in the form of a sofa;  
 FIG. 17 is a left-rear perspective view thereof;  
 FIG. 18 is a right-front perspective view of a seat showing my new design of FIG. 1 in the form of a sofa;  
 FIG. 19 is a left-rear perspective view thereof;  
 FIG. 20 is a right-front perspective view of a seat showing my new design of FIG. 5 in the form of a sofa;  
 FIG. 21 is a left-rear perspective view thereof;  
 FIG. 22 is a right-front perspective view of a seat showing my new design of FIG. 8 in the form of a sofa;  
 FIG. 23 is a left-rear perspective view thereof;  
 FIG. 24 is a right-front perspective view of a seat showing my new design of FIG. 10 in the form of a sofa;  
 FIG. 25 is a left-rear perspective view thereof;  
 FIG. 26 is a right-front perspective view of a seat showing my new design of FIG. 12 in the form of a sofa; and  
 FIG. 27 is a left-rear perspective view thereof.

The right side elevational views of FIGS. 10, 12, and 14 are identical to FIG. 7, the left sides being mirror images thereof;  
 The schematic depiction of fabric in all view is continuous throughout.  
 The characteristic feature of the design resides in the combination of inwardly slanting side panels.

## [56] References Cited

### U.S. PATENT DOCUMENTS

D. 80,598	3/1930	Bernhard	.....	D6/334
D. 180,478	6/1957	Gern	.....	D6/334
D. 234,171	1/1975	Long	.....	D6/334
D. 241,795	10/1976	Fister	.....	D6/334
D. 244,069	4/1977	Summer	.....	D6/381
D. 255,515	6/1980	Friedman	.....	D6/371
D. 256,193	8/1980	Collins	.....	D6/334
D. 258,401	3/1981	Beall, Jr.	.....	D6/381
D. 318,183	7/1991	Fister, Jr.	.....	D6/334

### OTHER PUBLICATIONS

Illums Bolighus, May, 1961, Sofa #28158 shown.  
 Hayes, 1972, chair #271-21 bottom right.  
 Furniture Specialties, sofa #1105 shown.  
 Taylor Chair Company, Chair #B1730SWS at top right.  
 Taylor Chair Co., Chair #2030 bottom left.  
 Waynline, Jul. 1980, Chair #579/100 at far left.  
 Abitare Identikit, Isadora sofa shown on p. 47.  
 Global, ©1987, p. 18, chair at bottom left.

*Primary Examiner*—Carmen H. Vales-Lado  
*Assistant Examiner*—Gary D. Watson  
*Attorney, Agent, or Firm*—Rhodes, Coats & Bennett

## [57] CLAIM

The ornamental design for a seat, as shown and described.

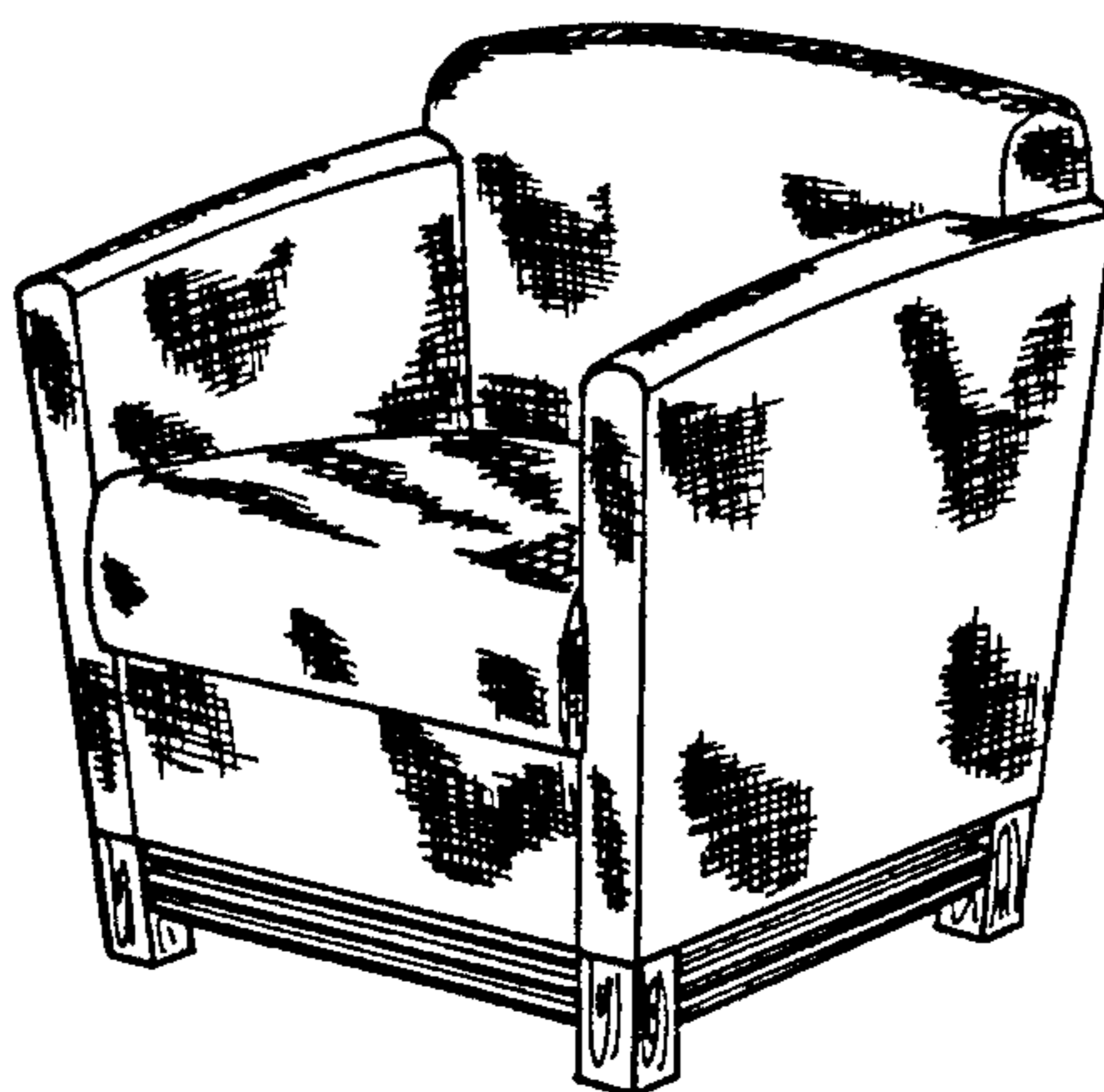

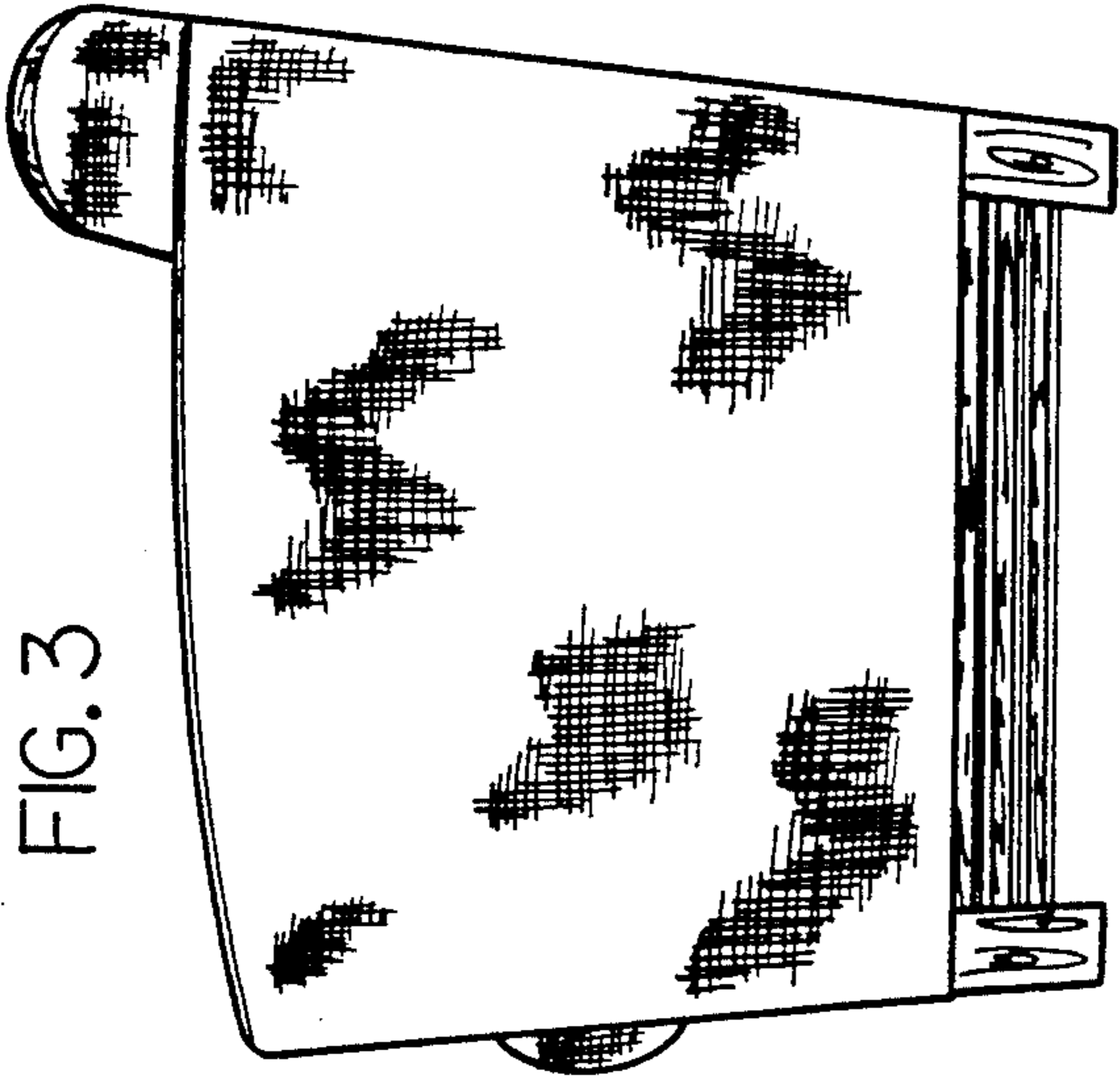

FIG. 3

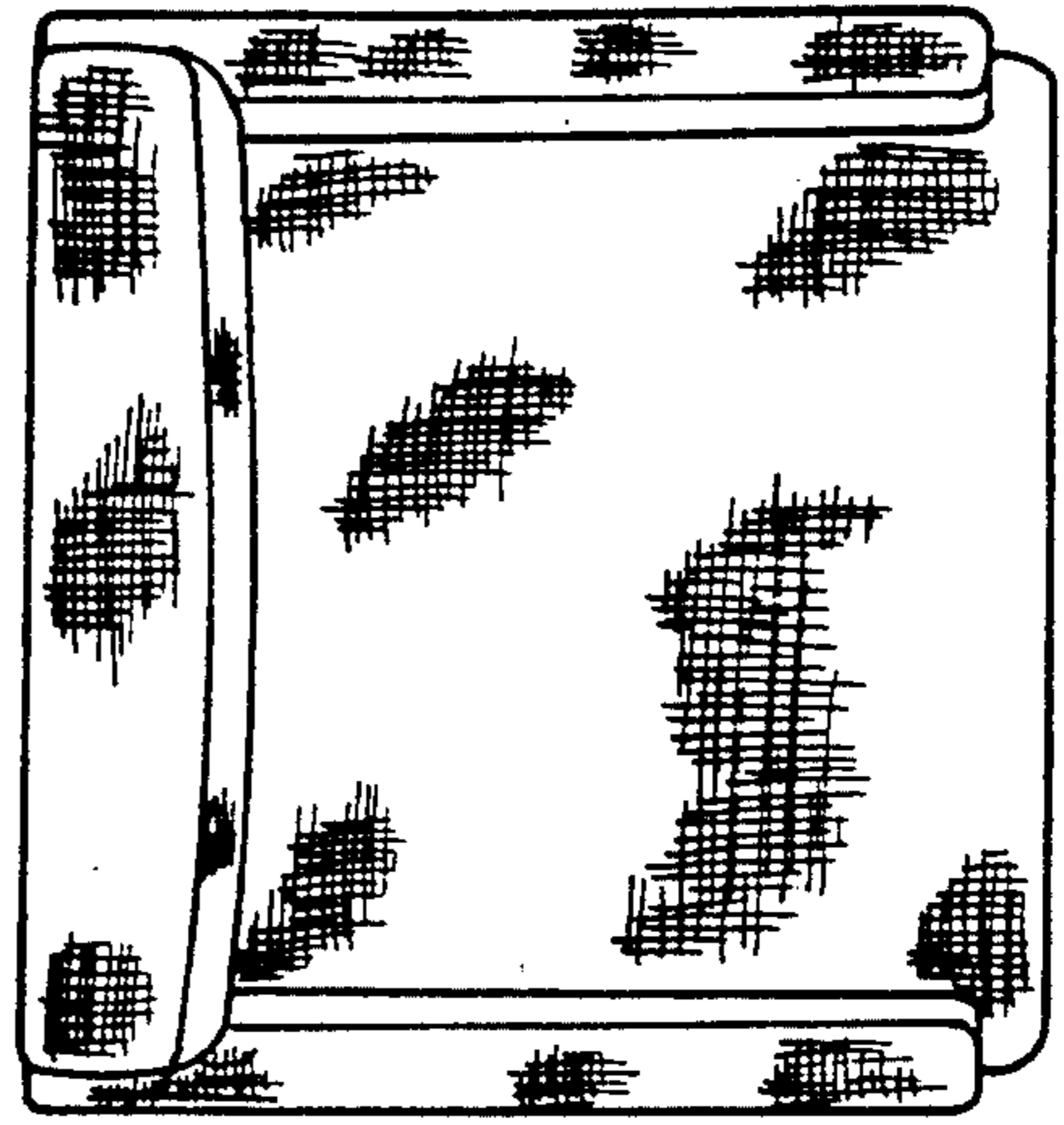

FIG. 4

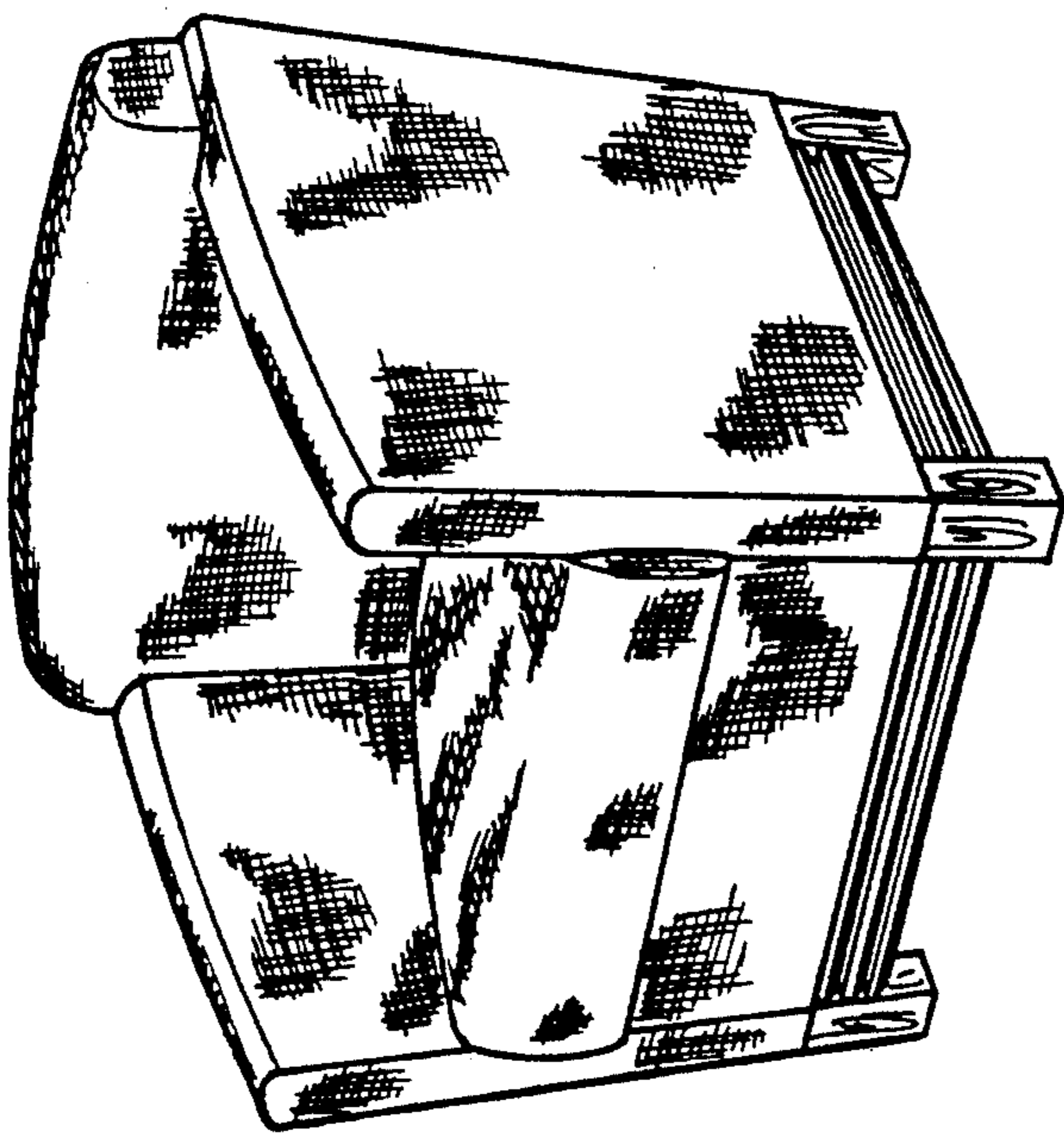

FIG. 1

FIG. 2

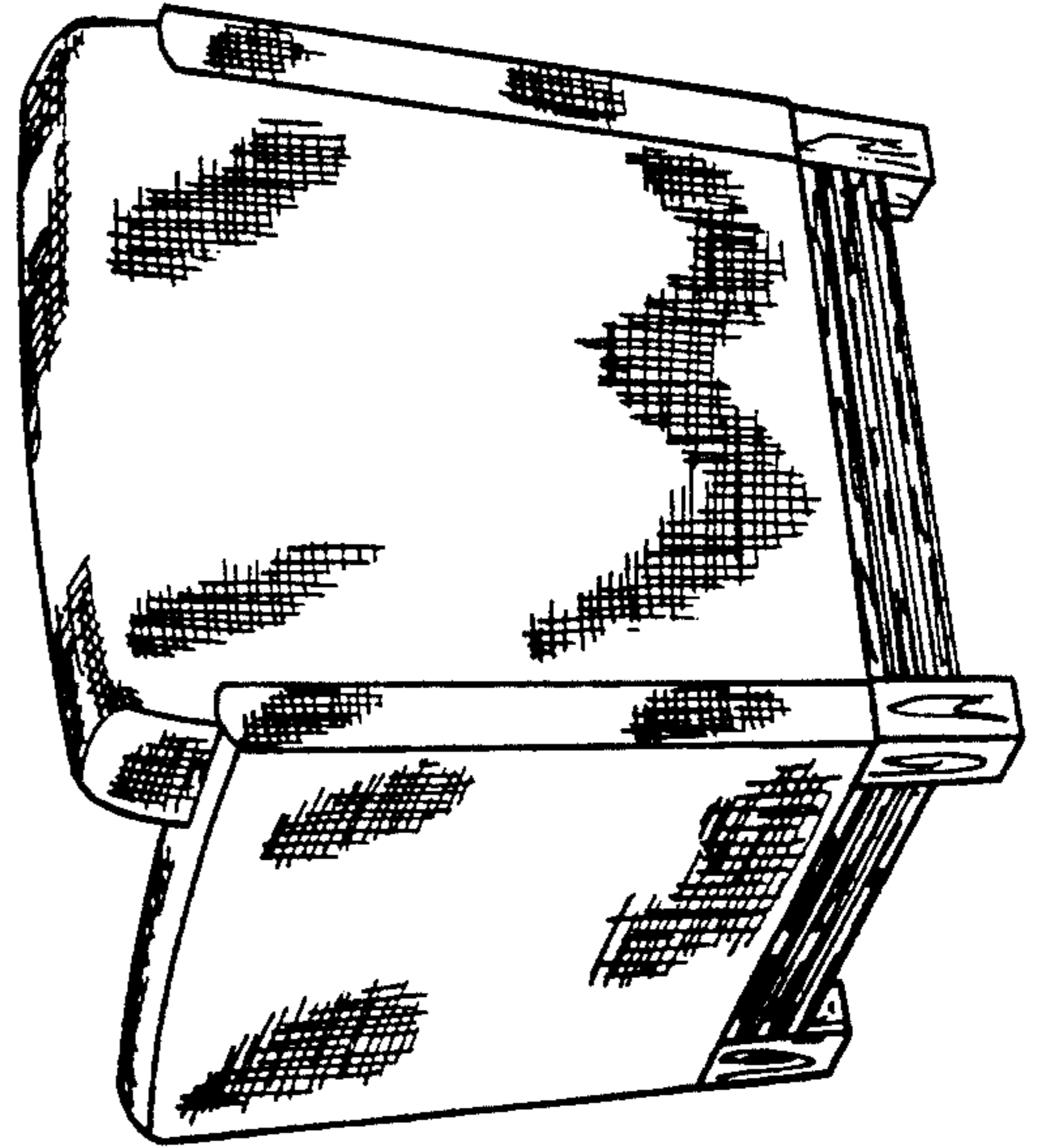

FIG. 6

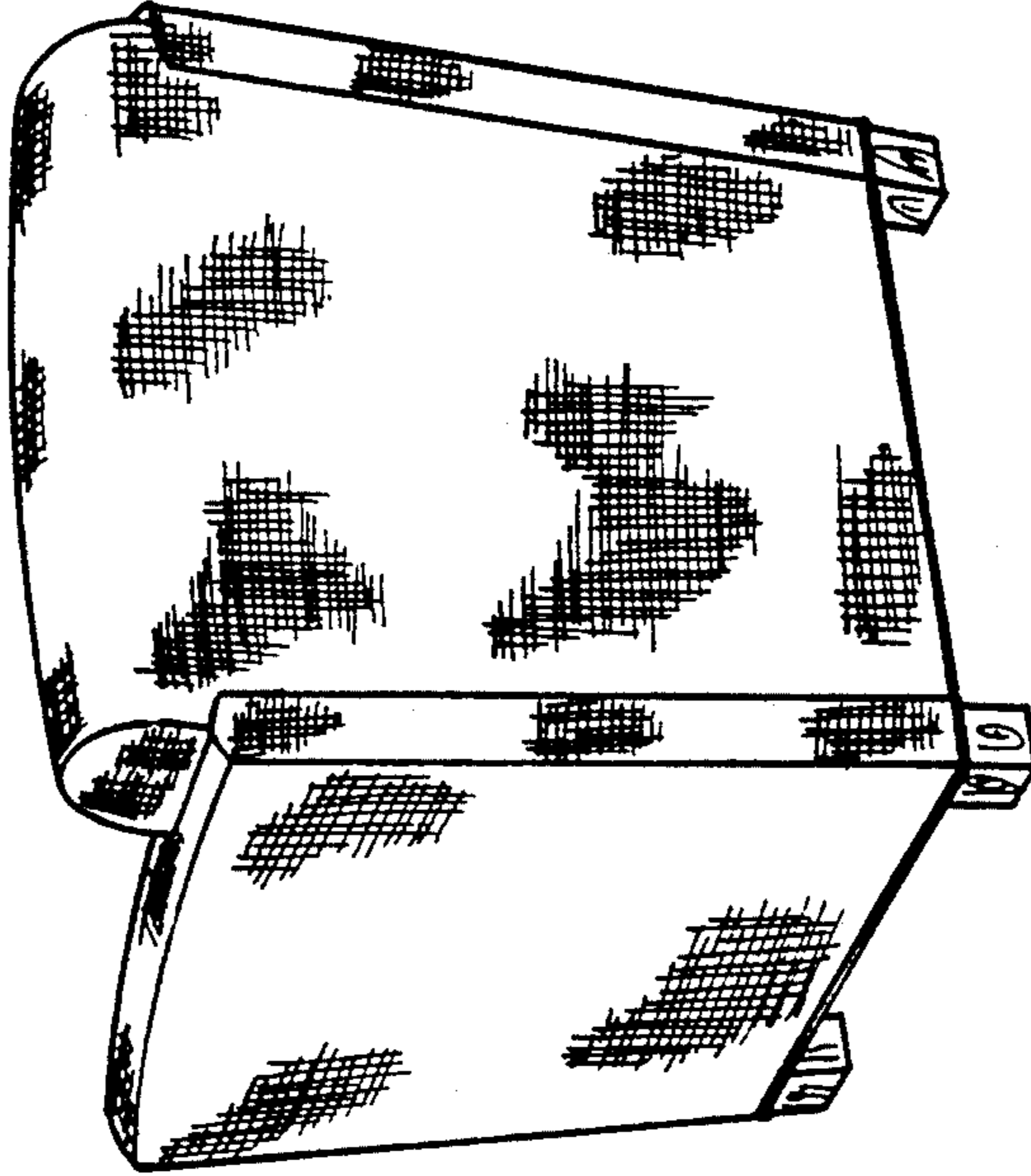
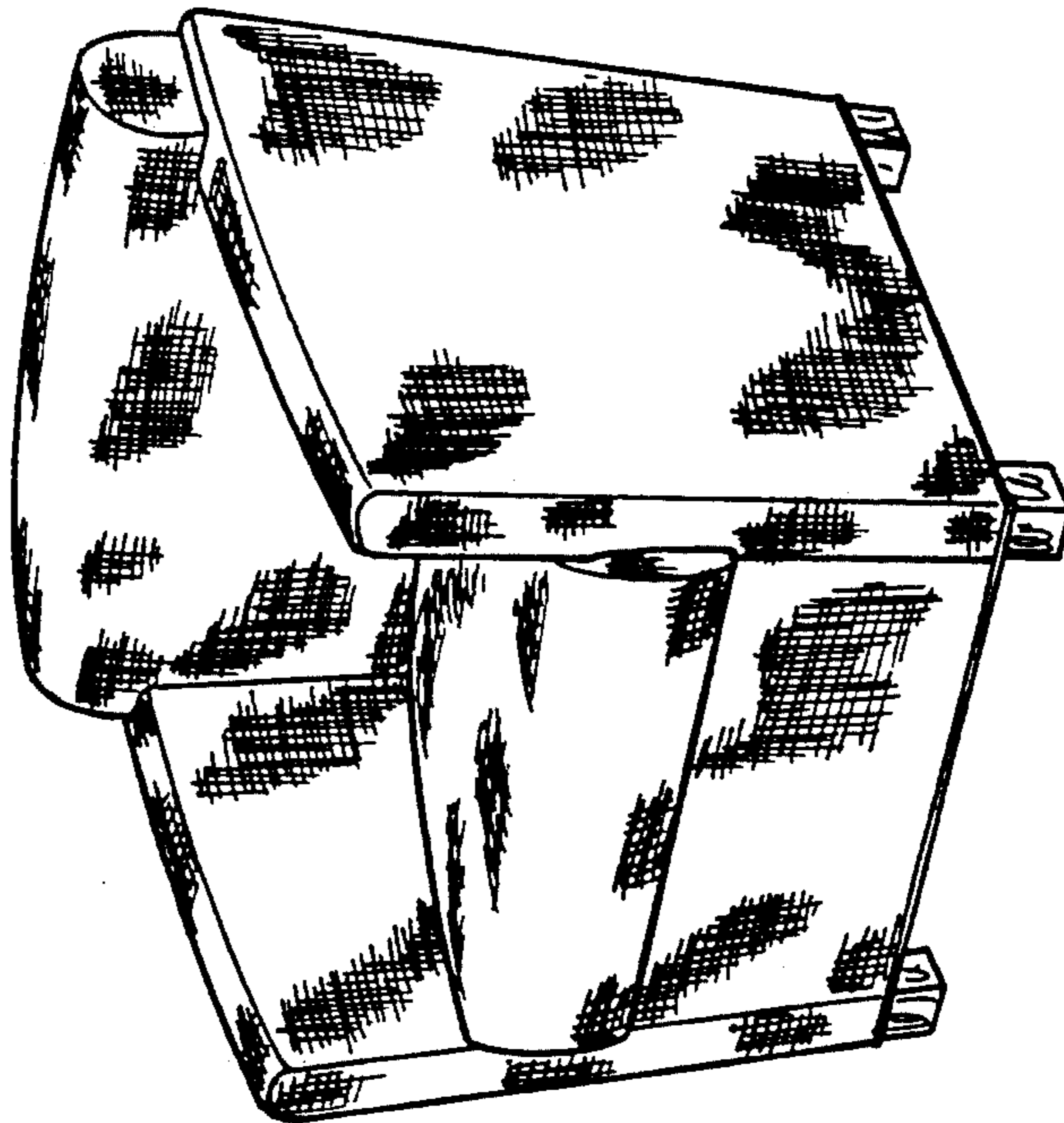

FIG. 5



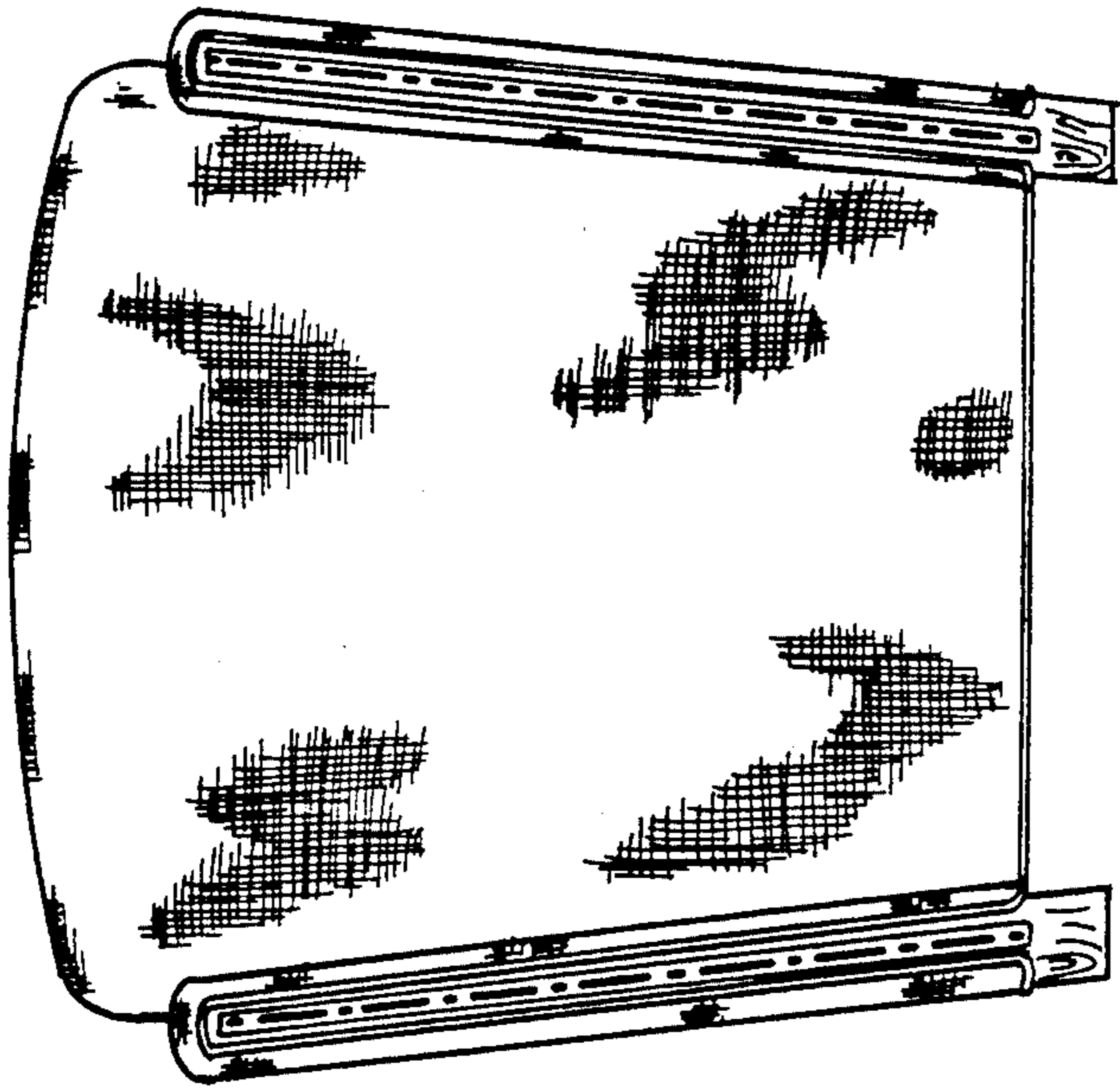

FIG. 9

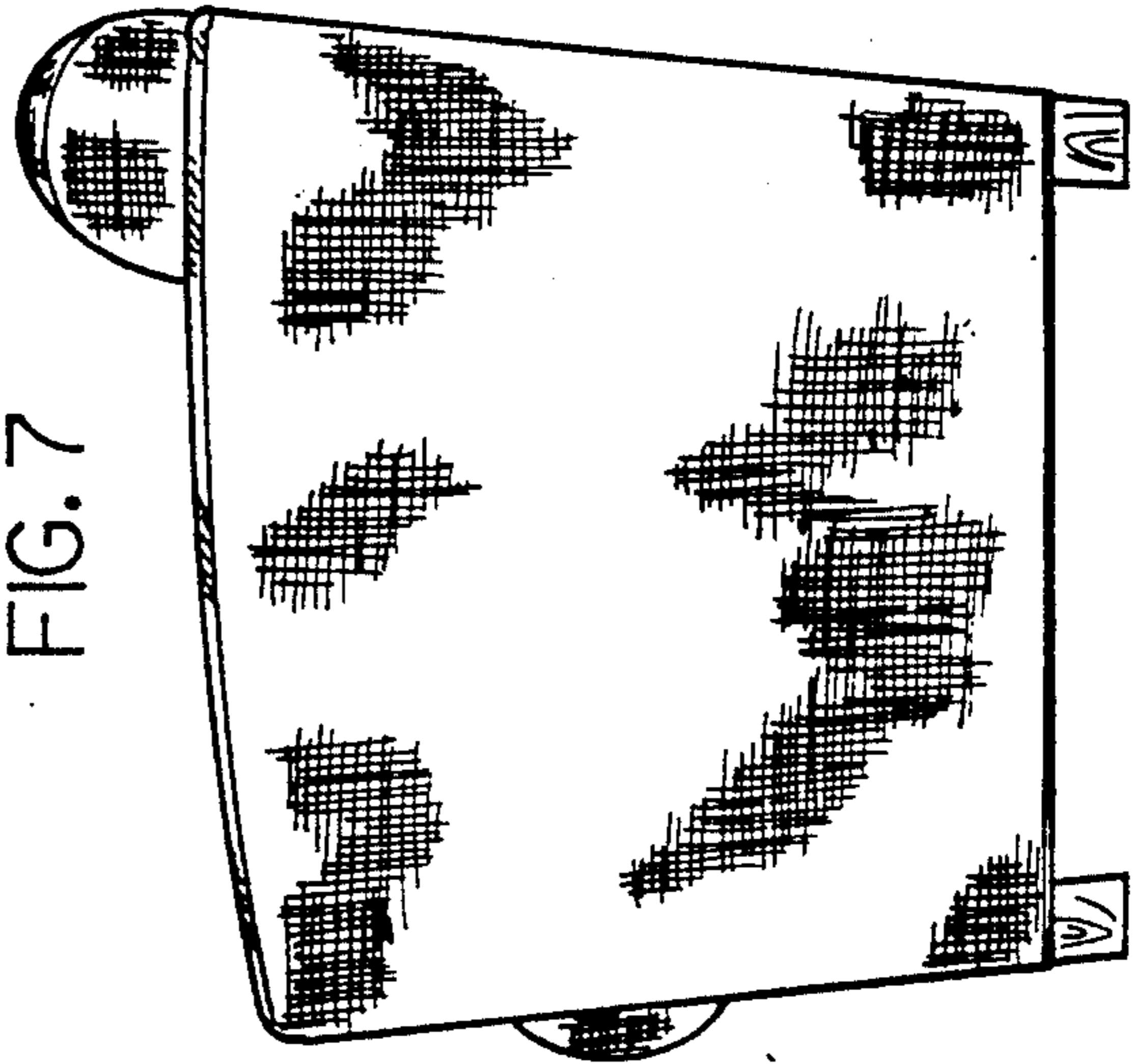

FIG. 7

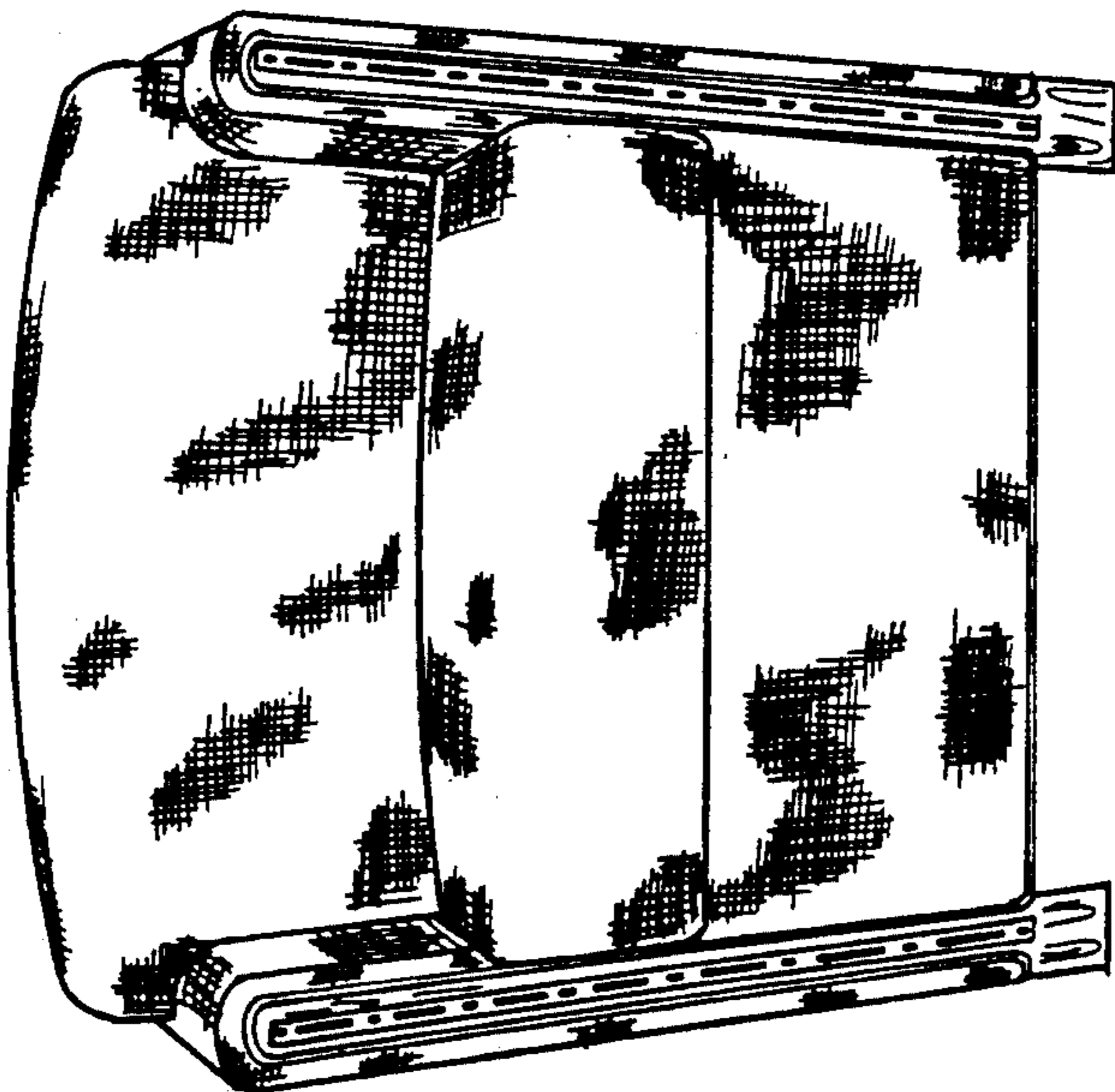

FIG. 8

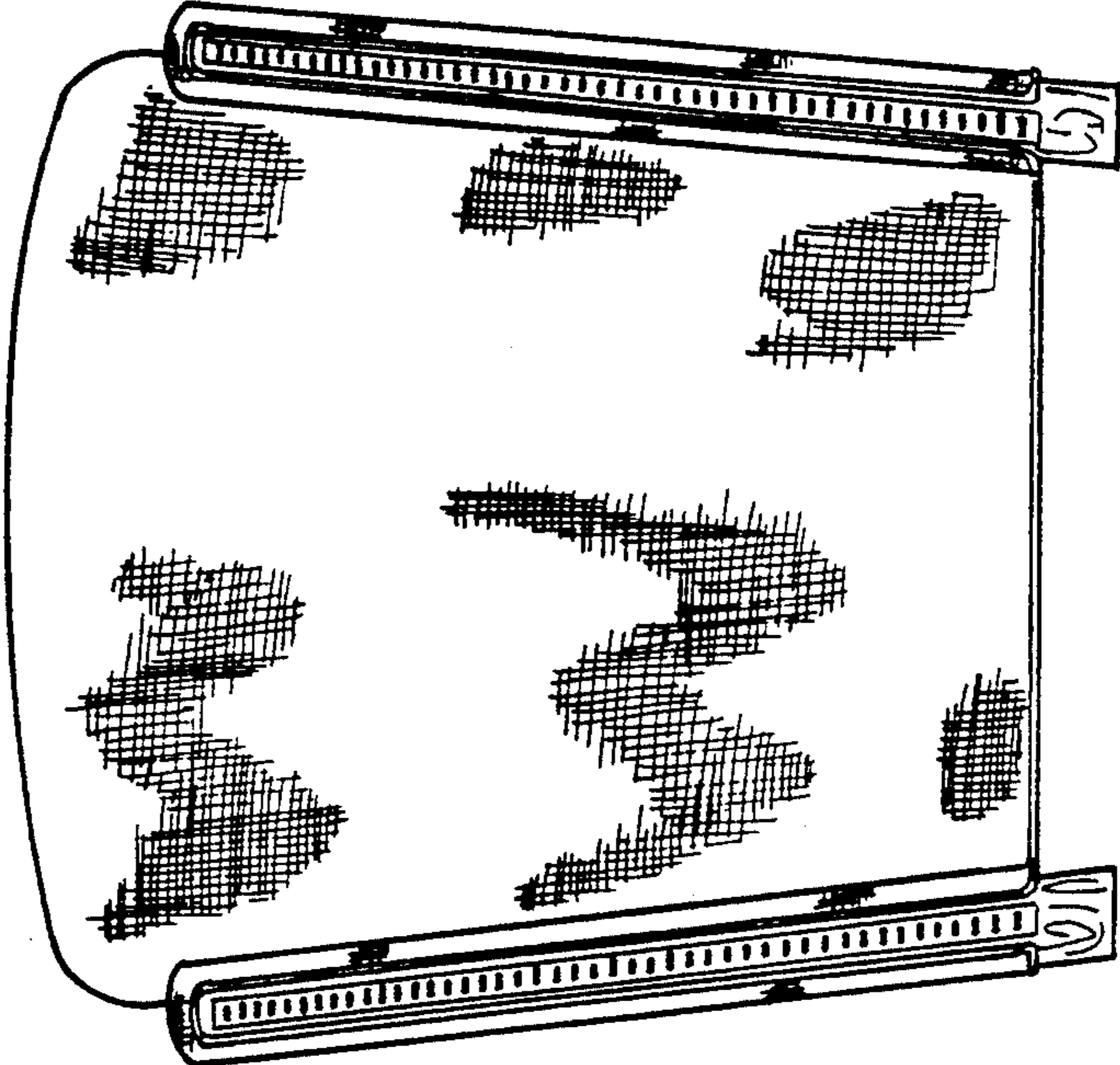

FIG. 11

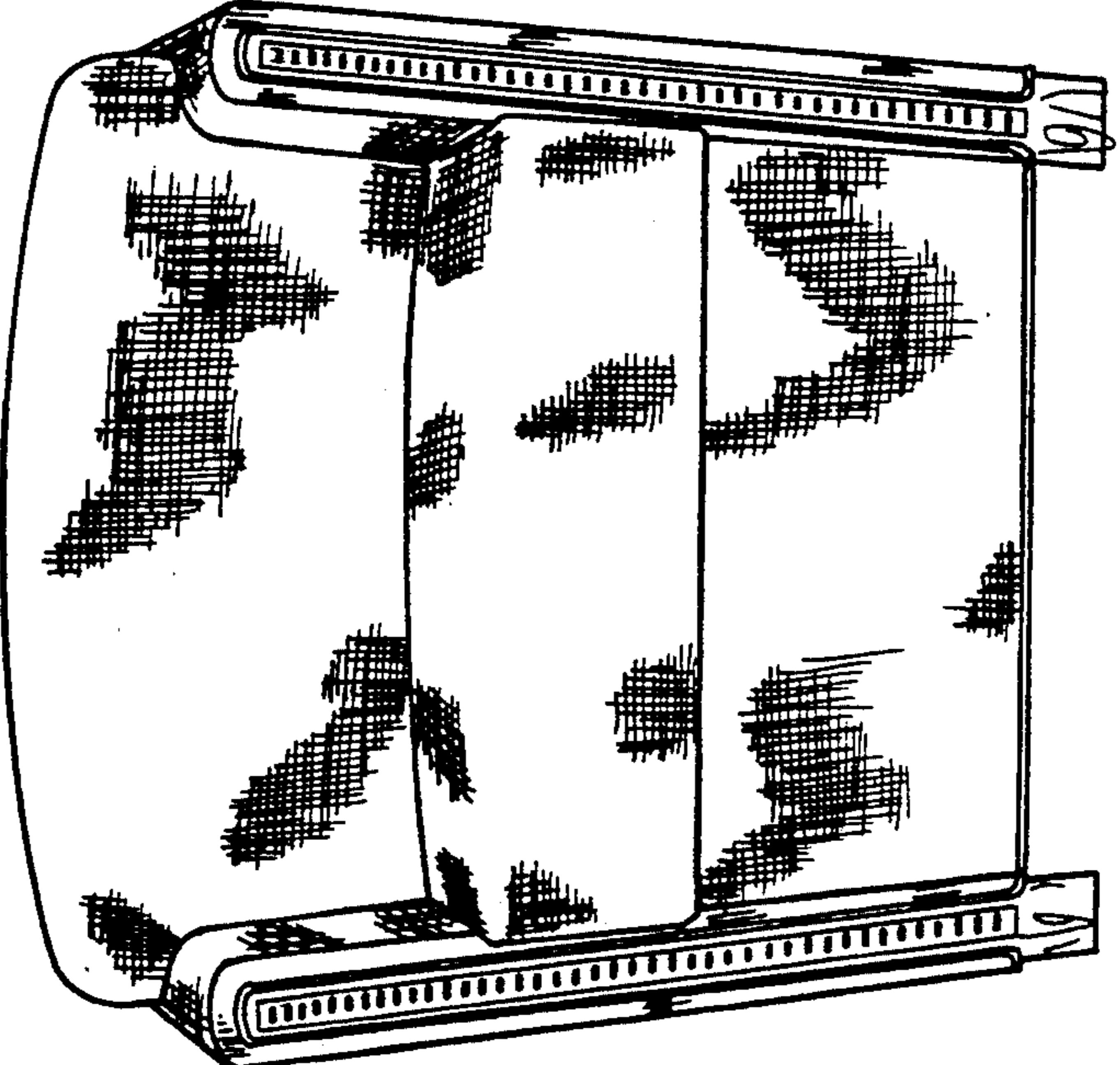

FIG. 10

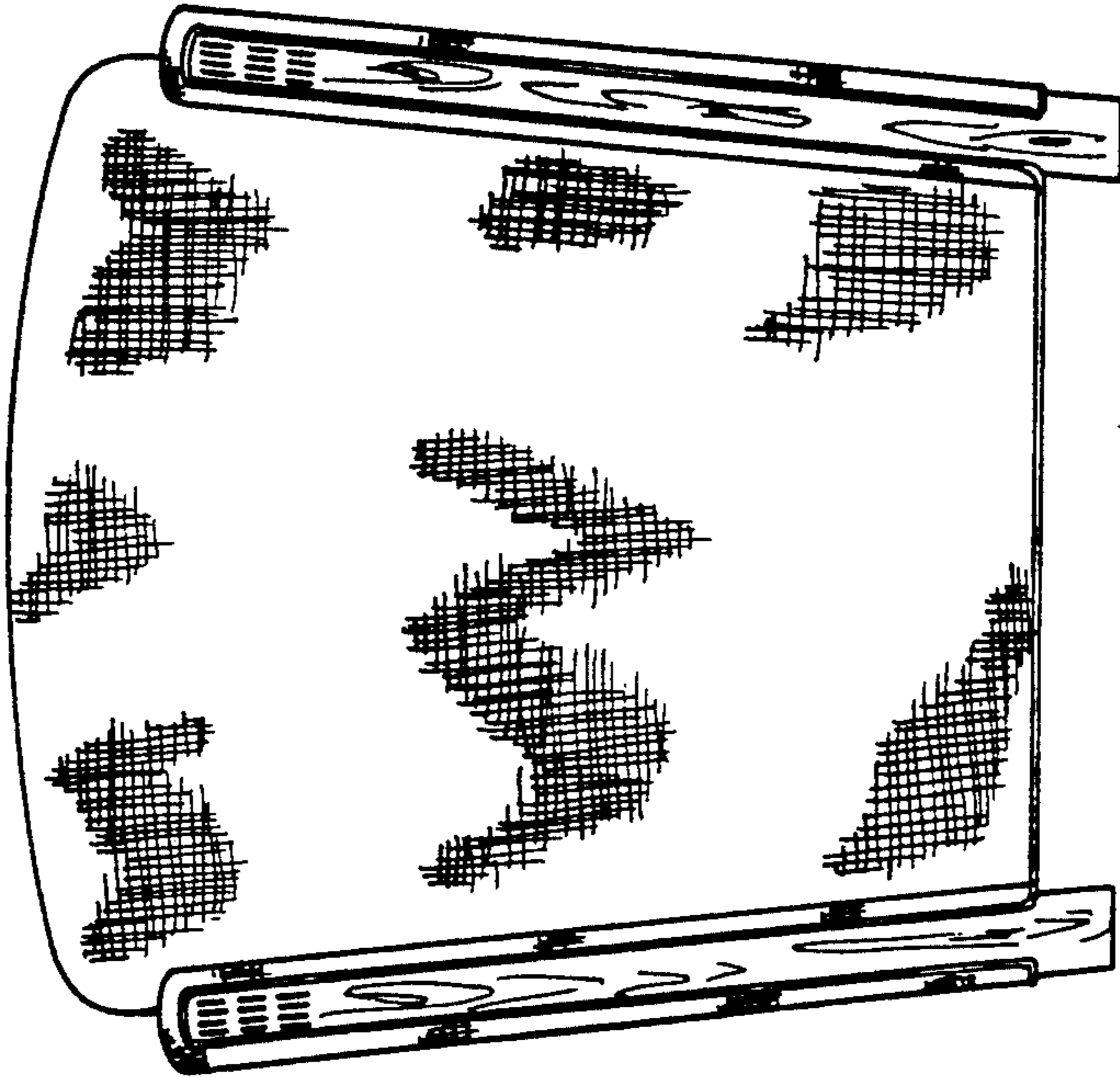

FIG. 13

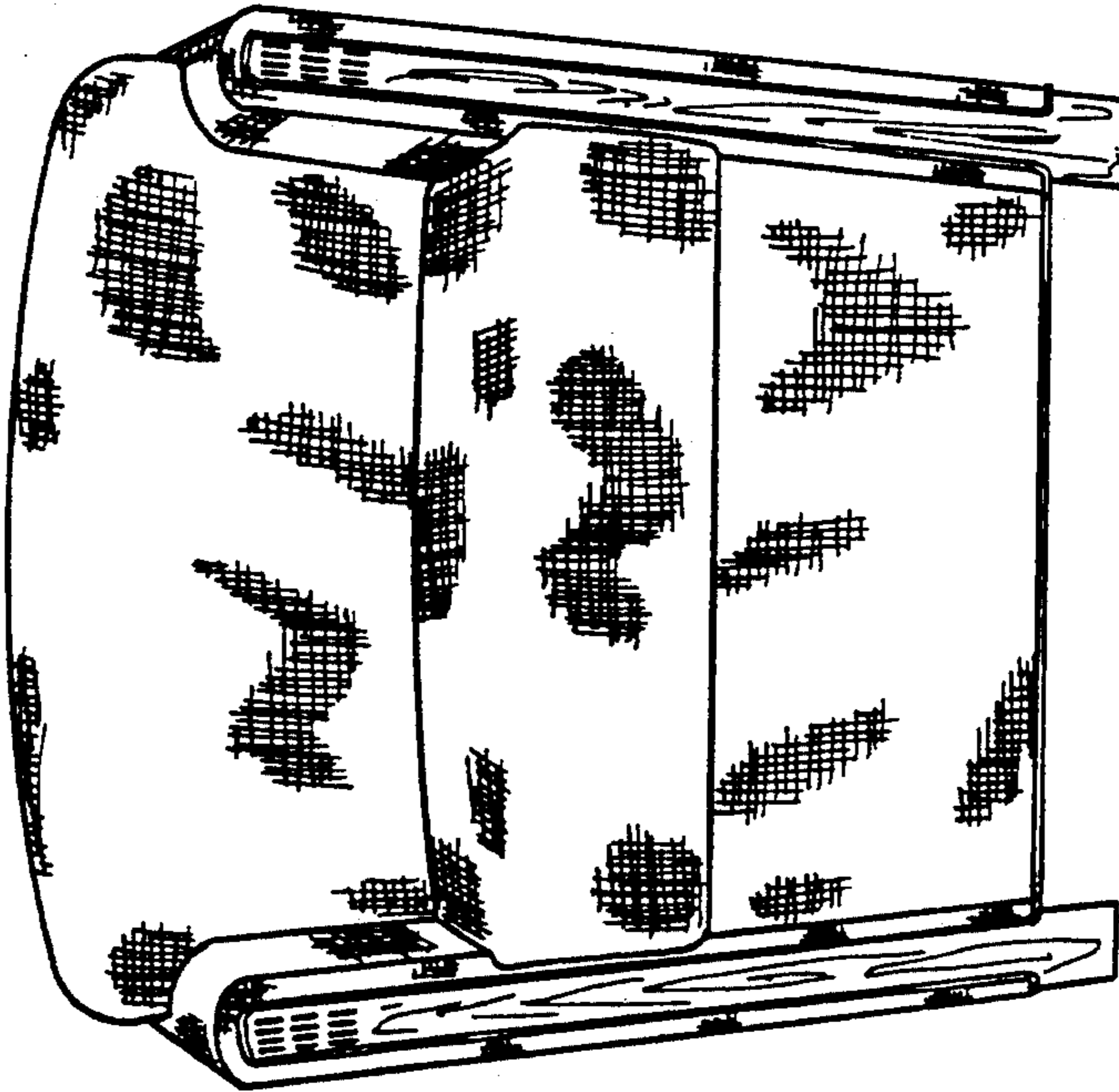

FIG. 12

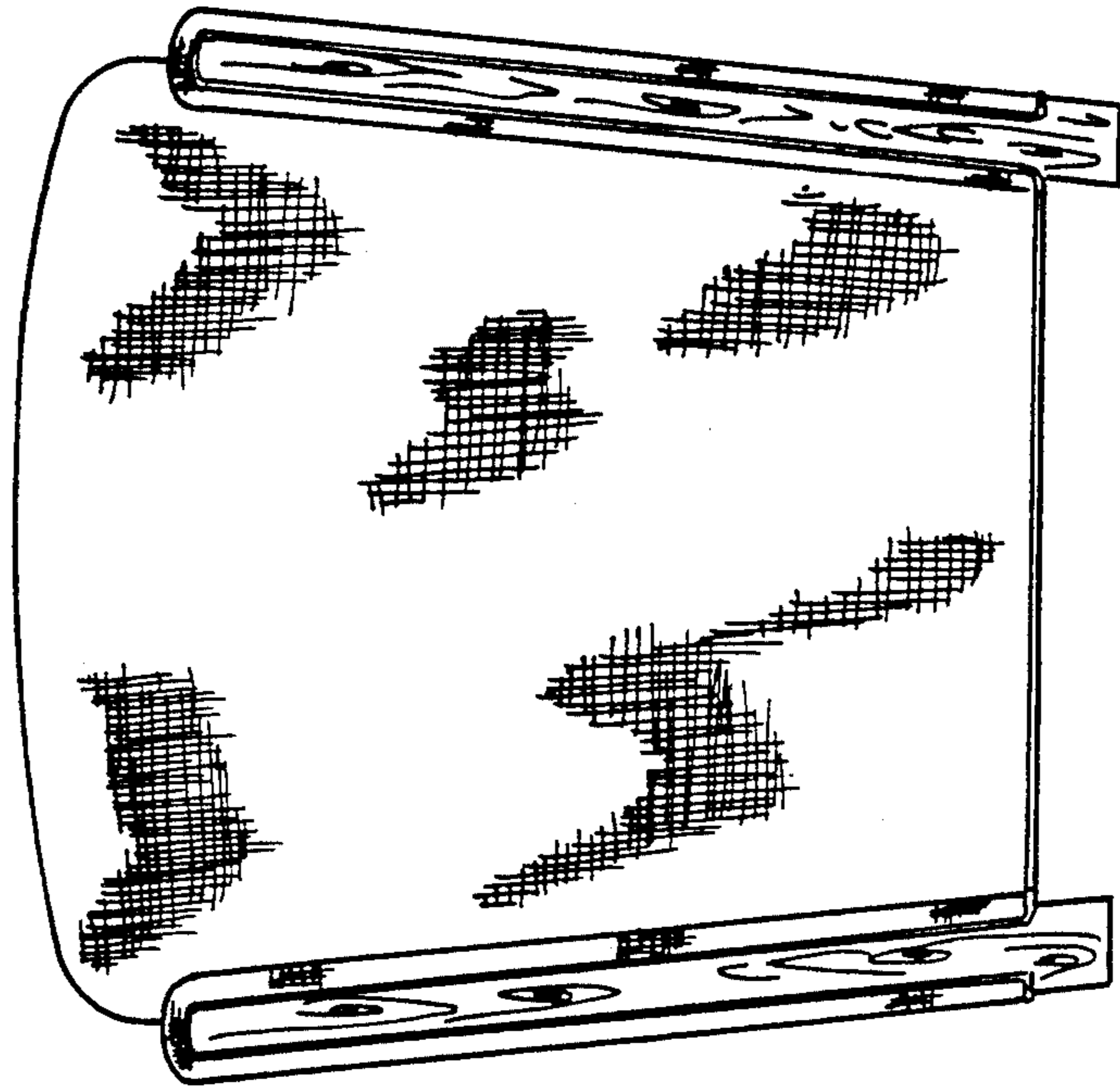

FIG. 15

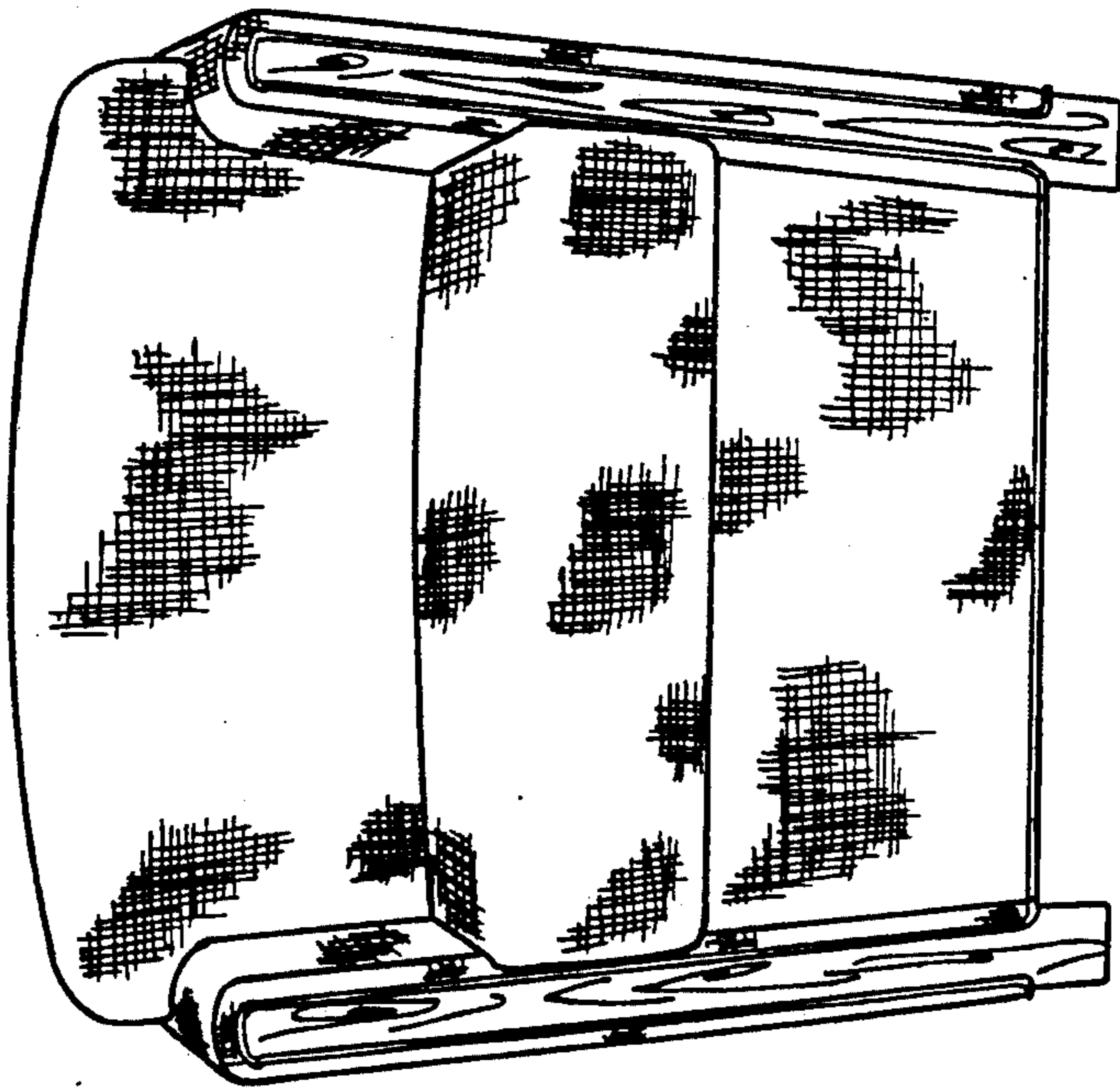

FIG. 14

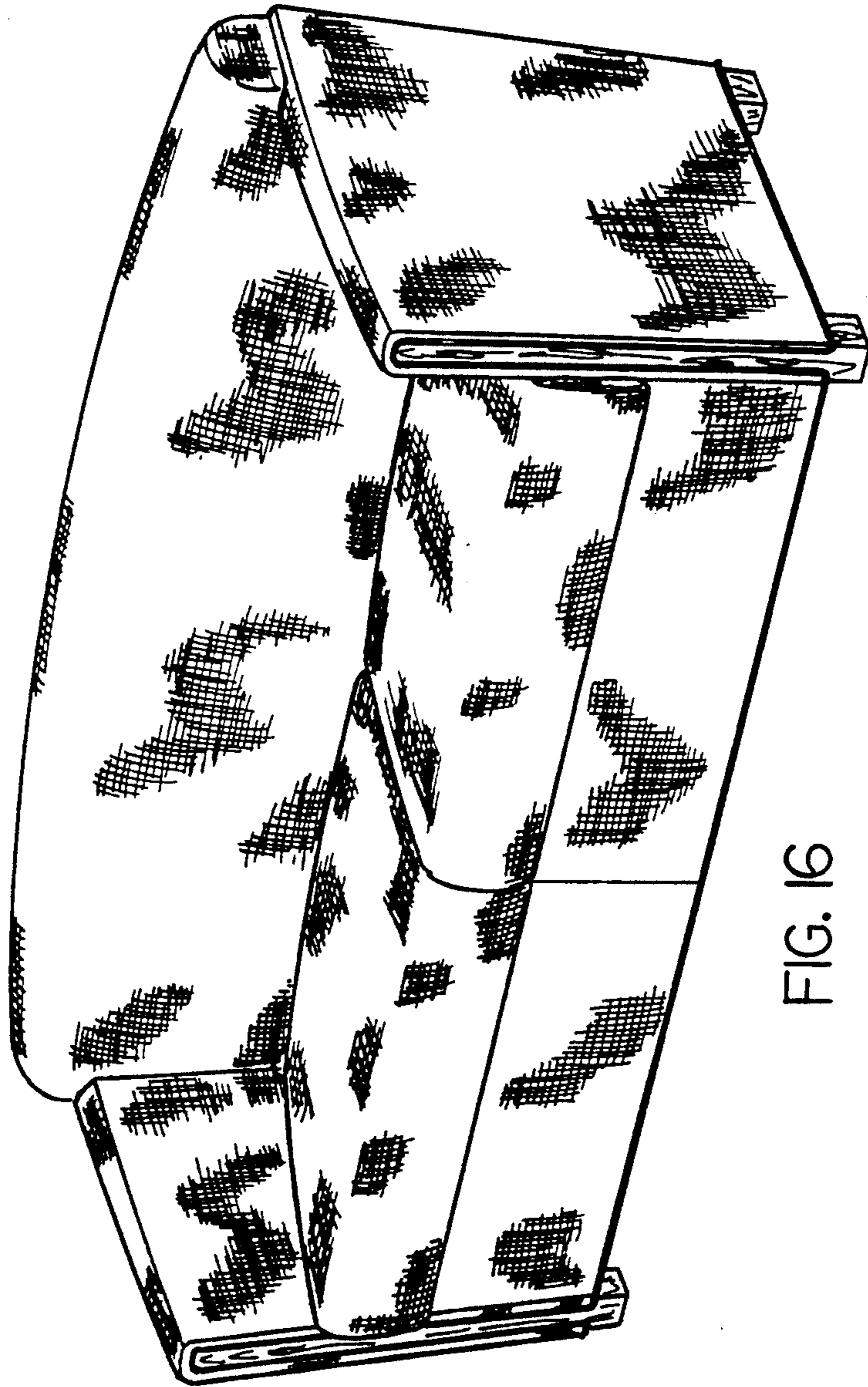

FIG. 16



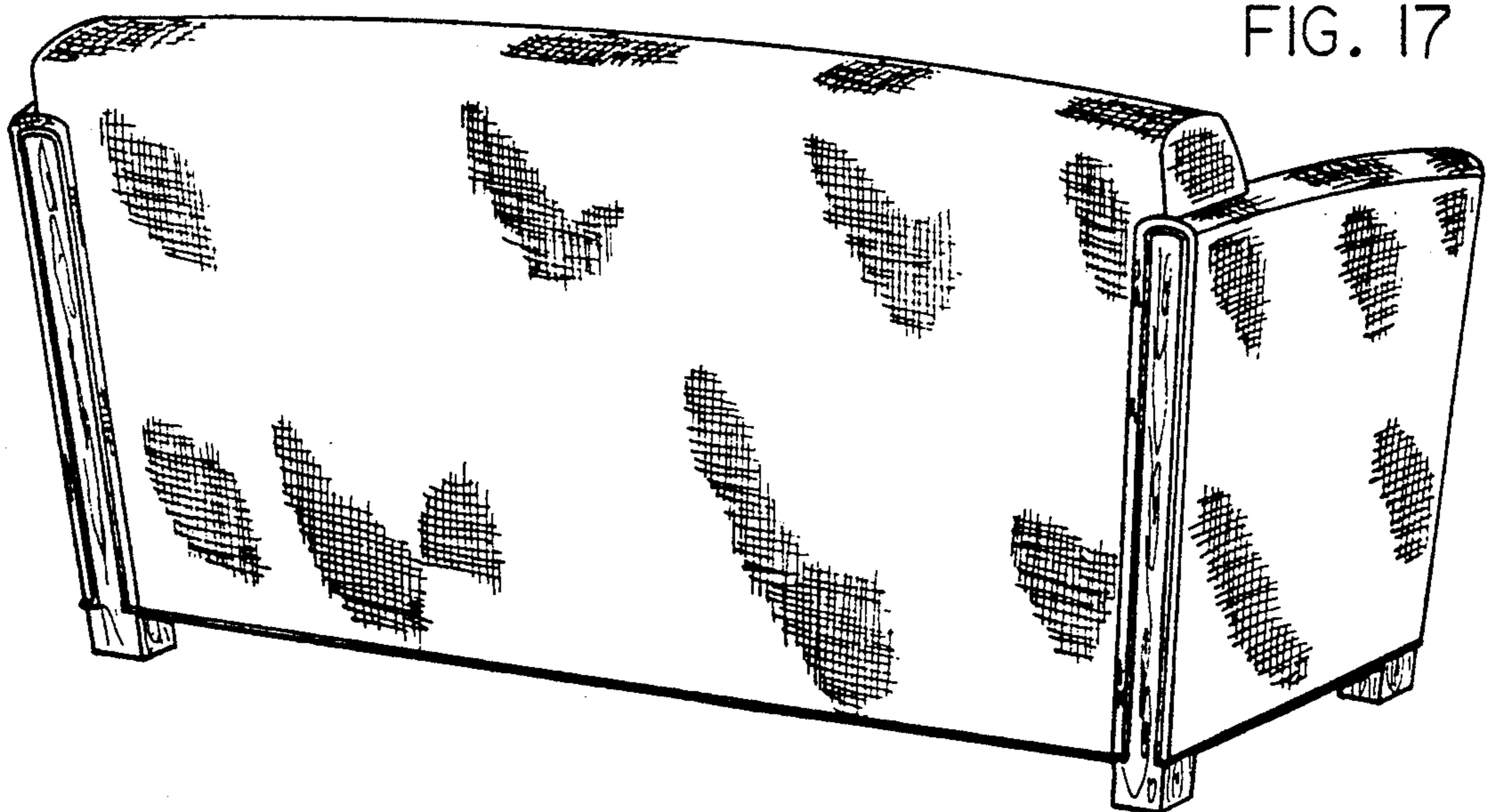

FIG. 17

FIG. 19

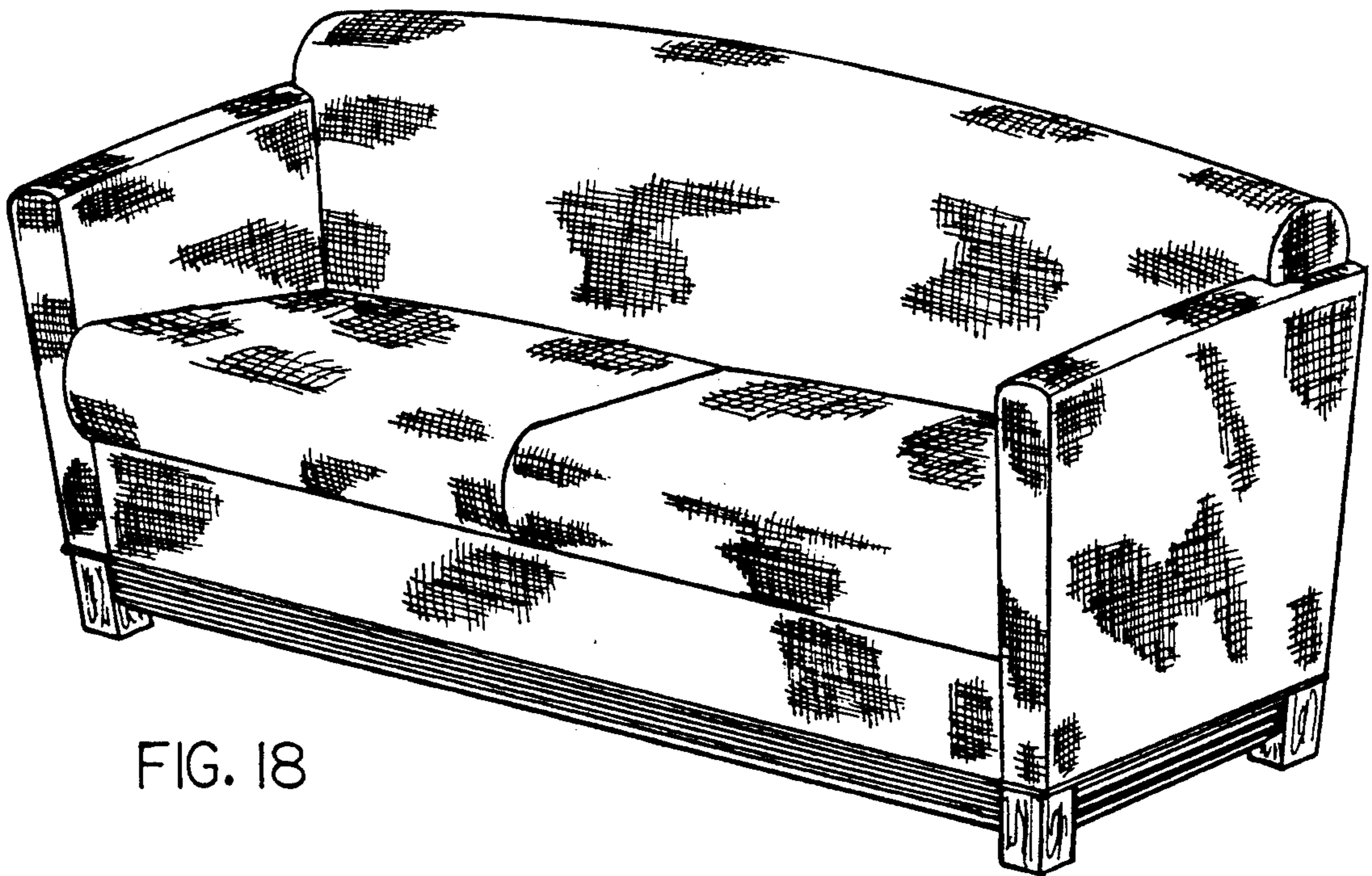
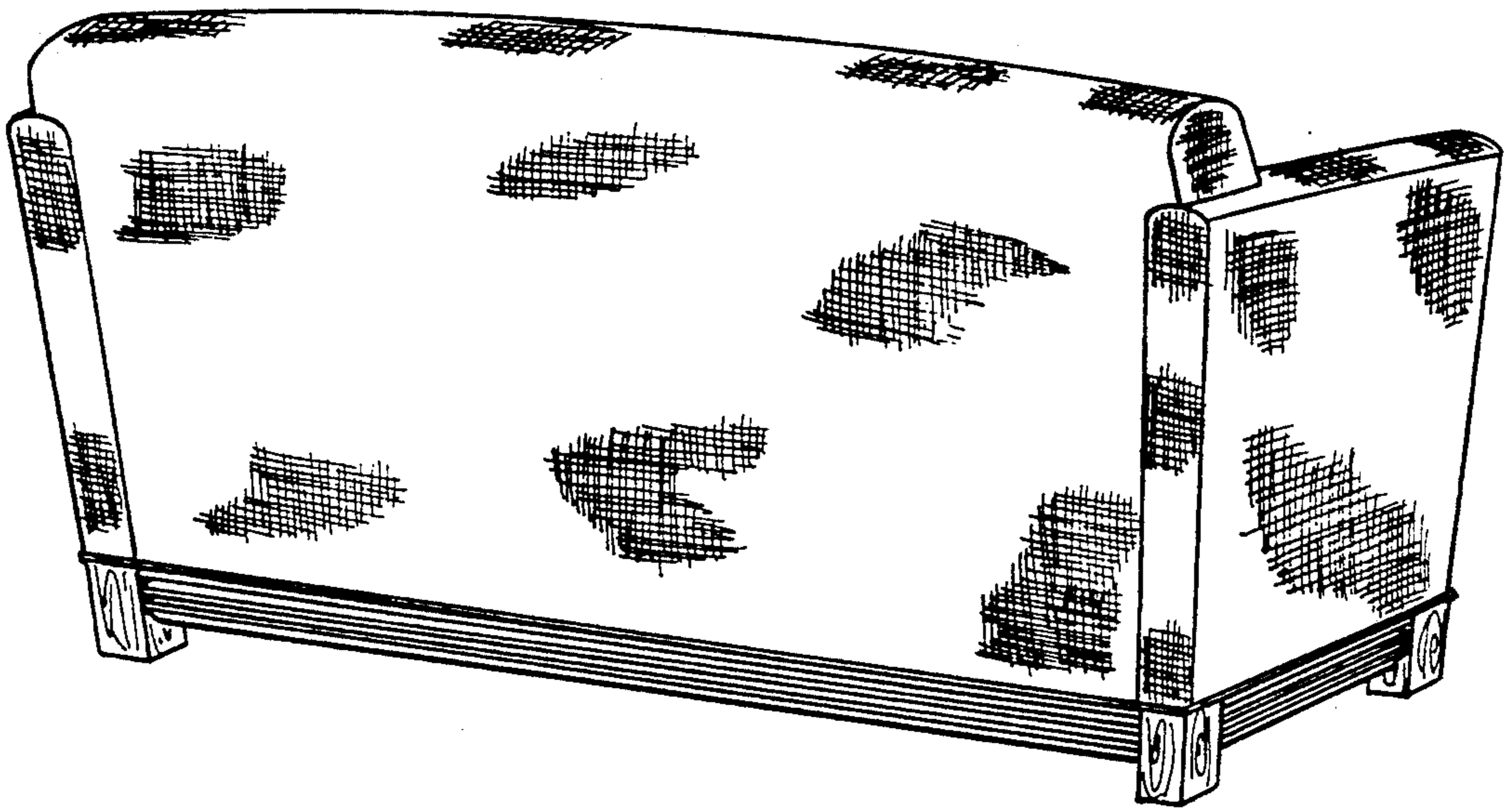

FIG. 18

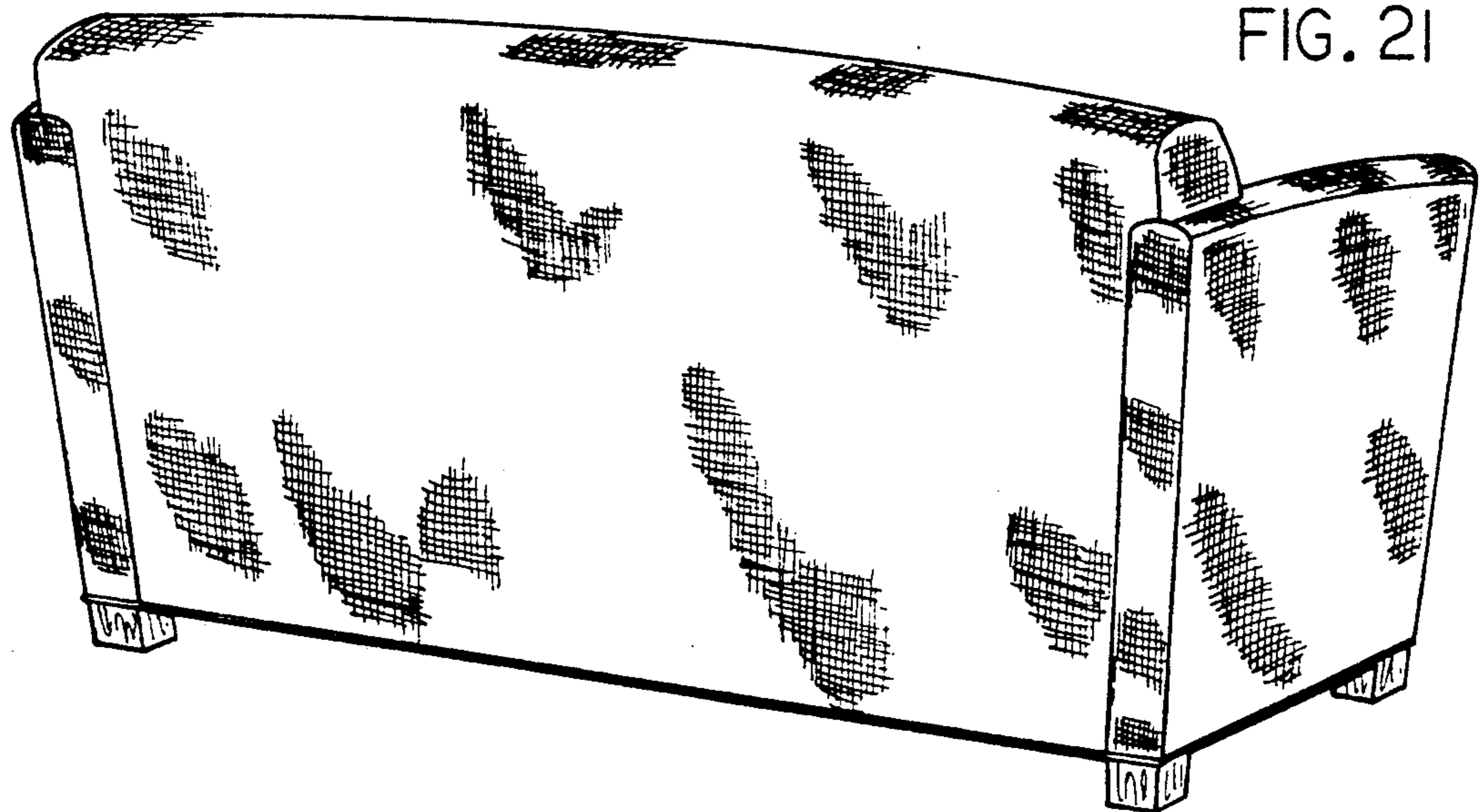

FIG. 21

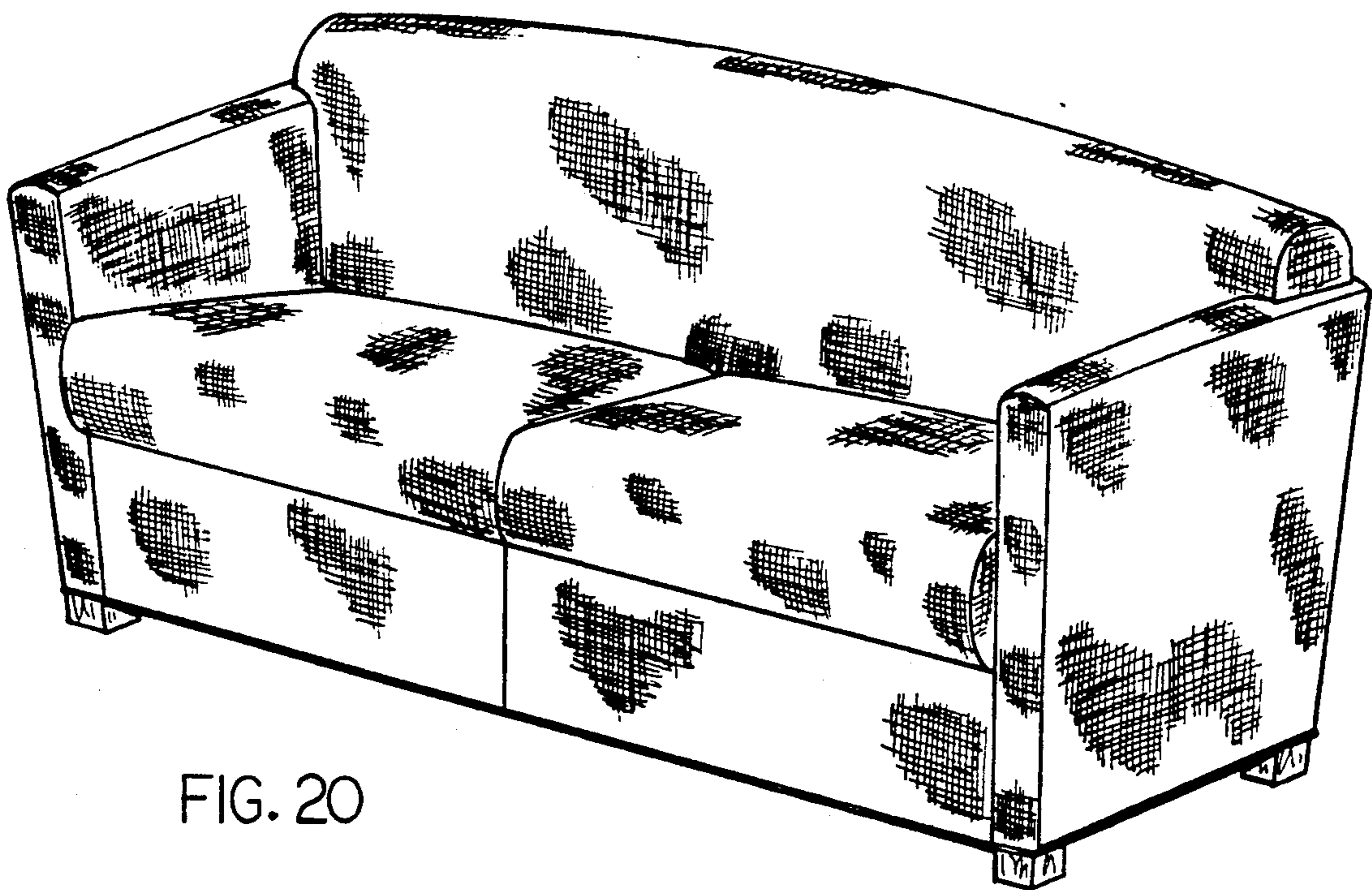

FIG. 20

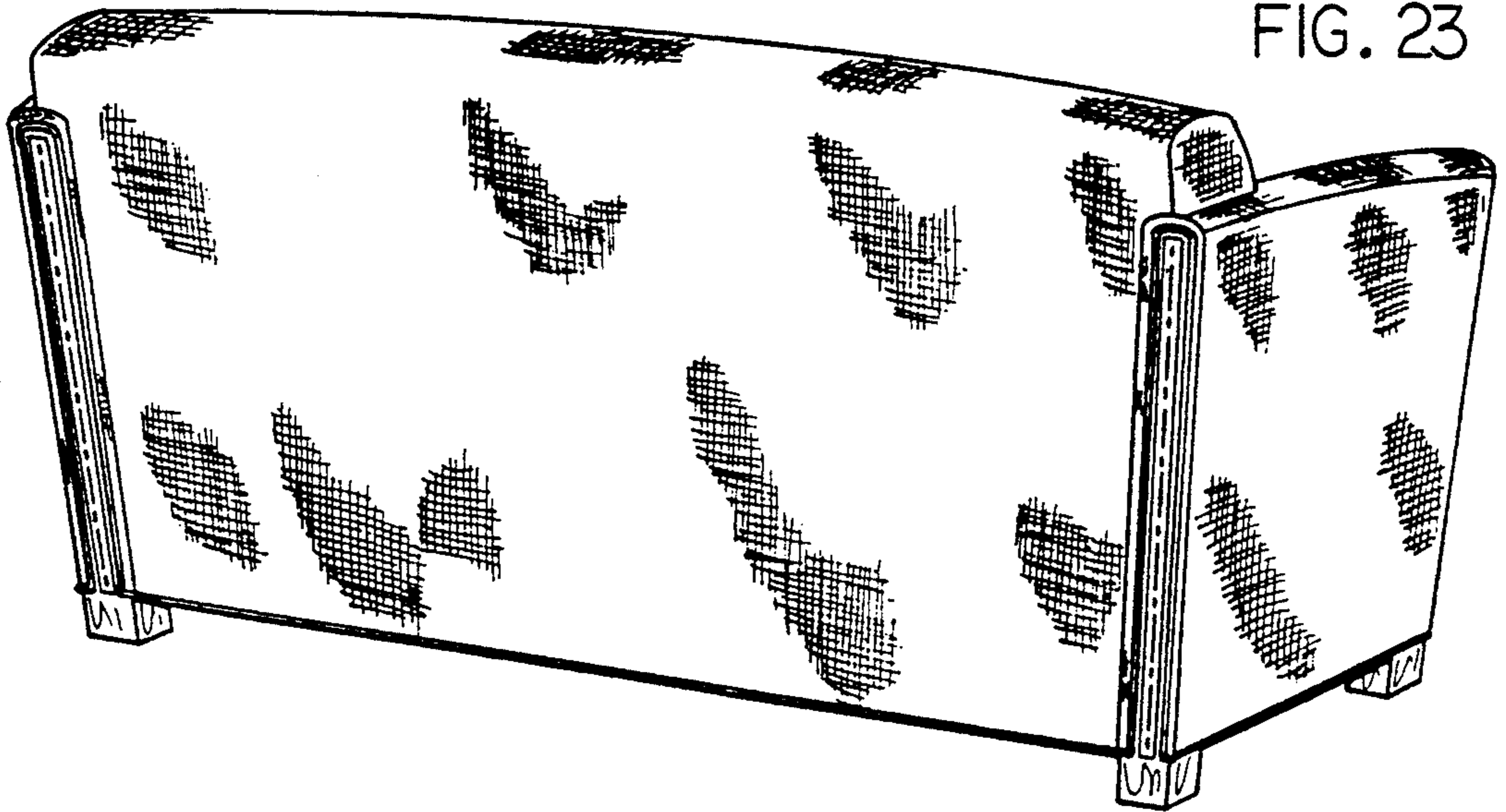

FIG. 23

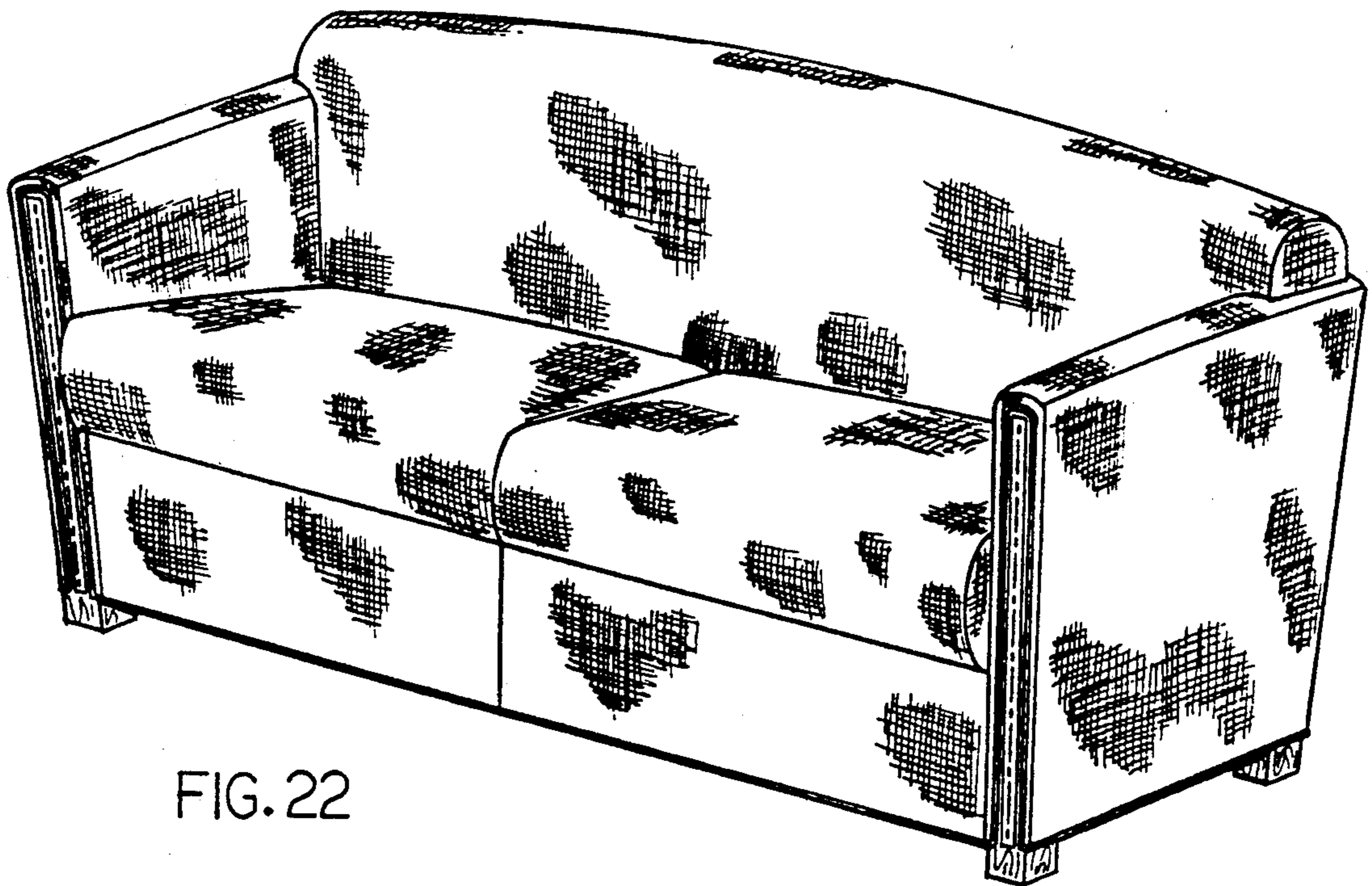

FIG. 22

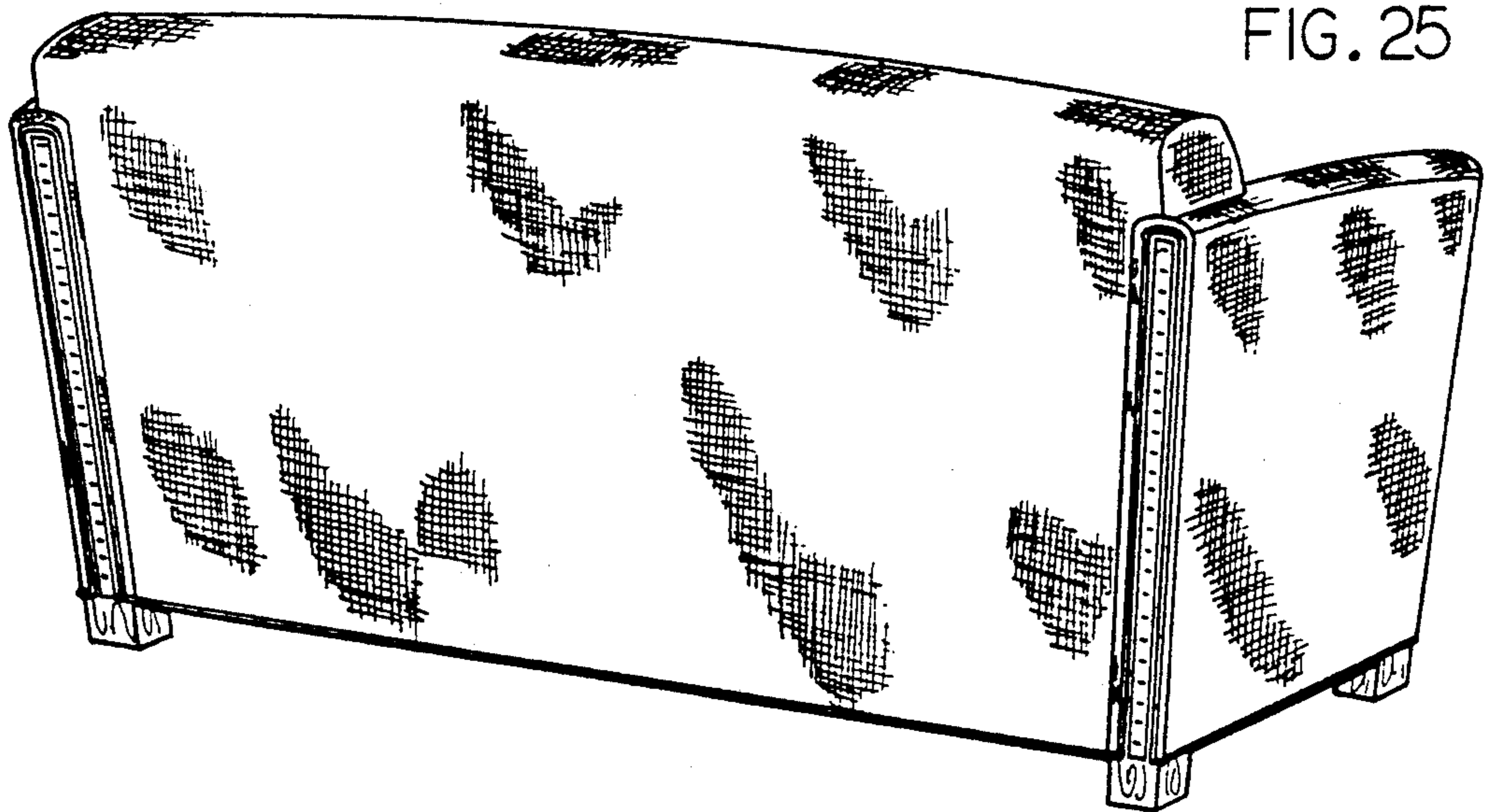

FIG. 25

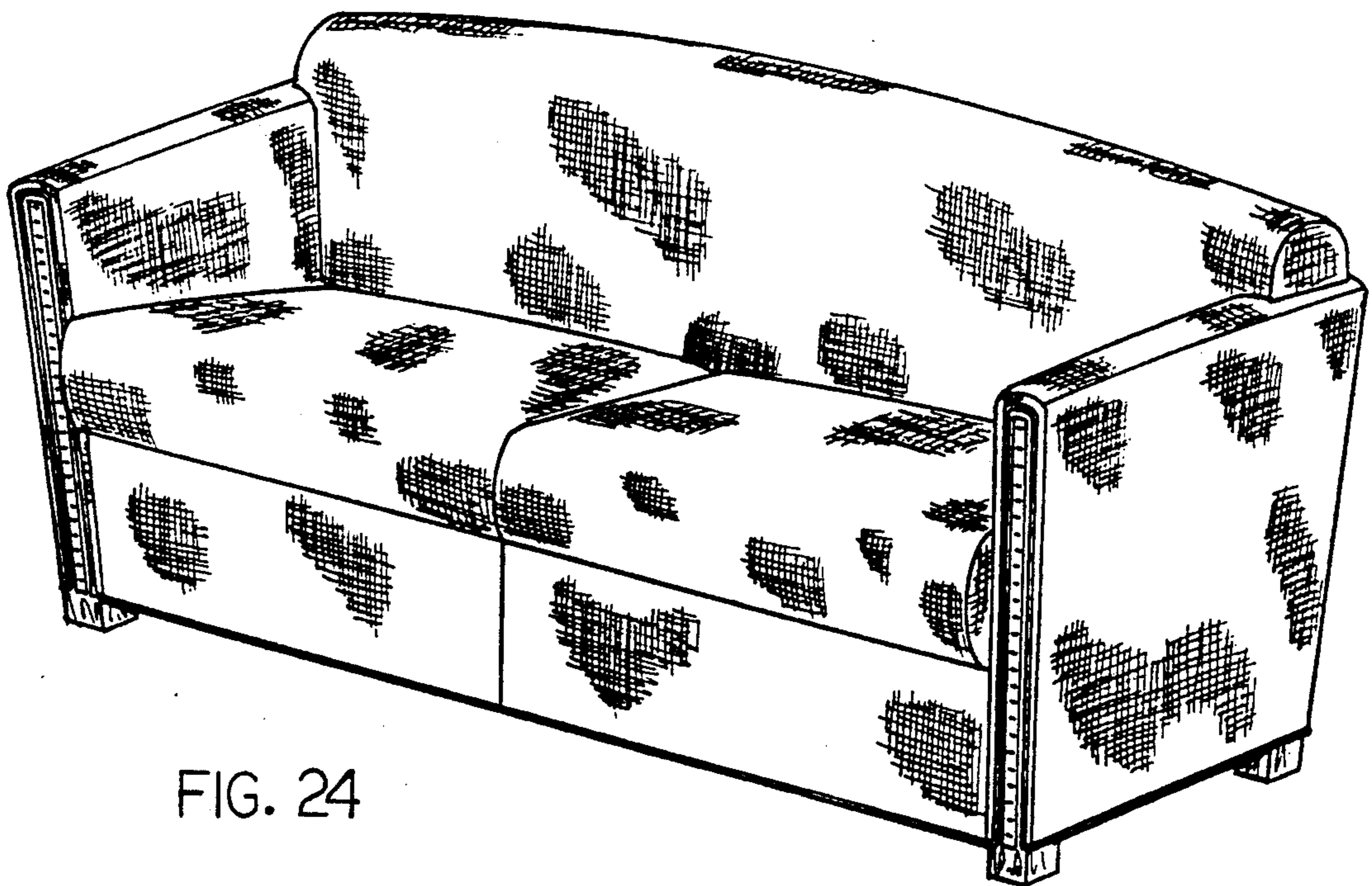

FIG. 24

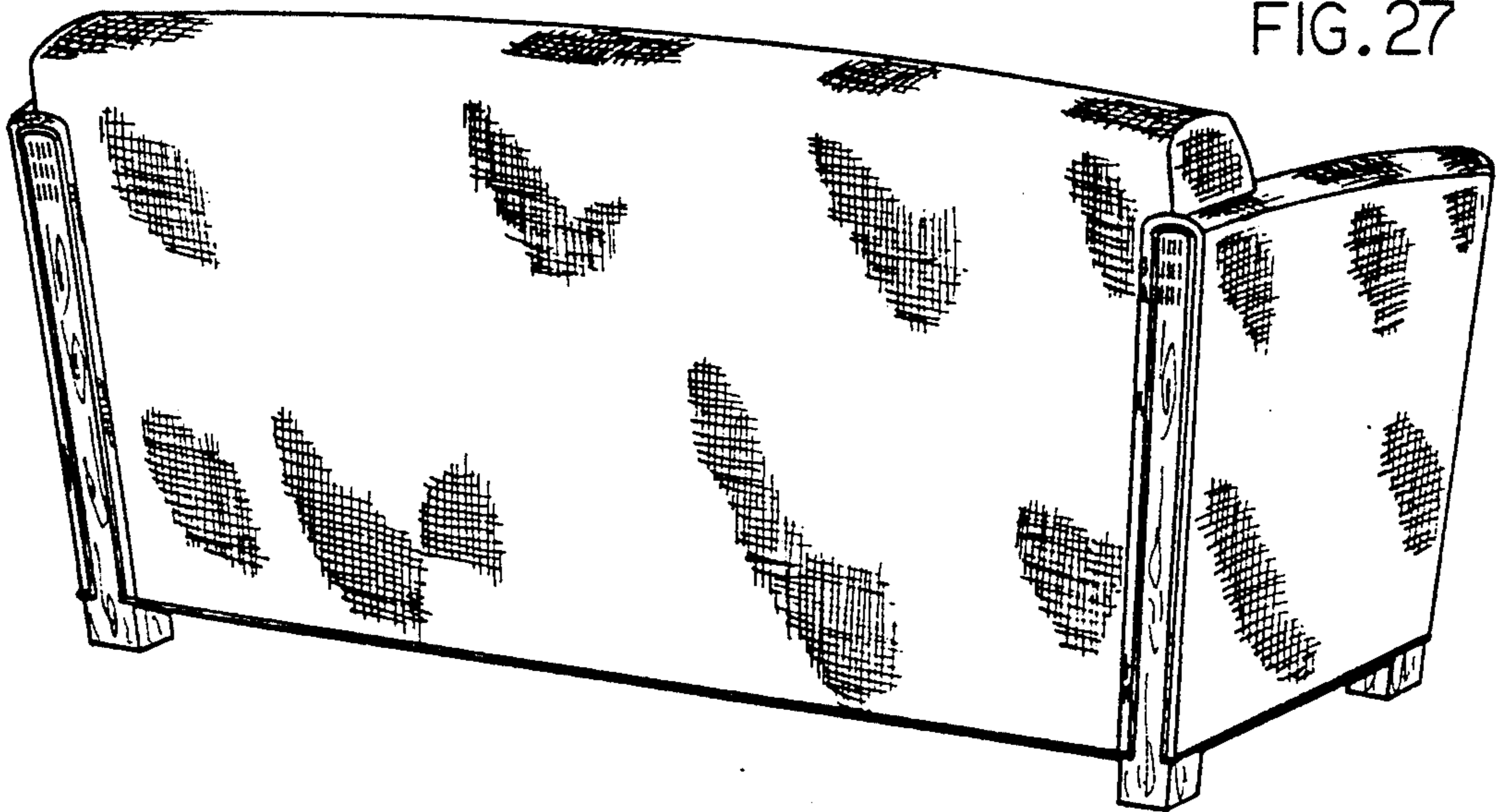

FIG. 27

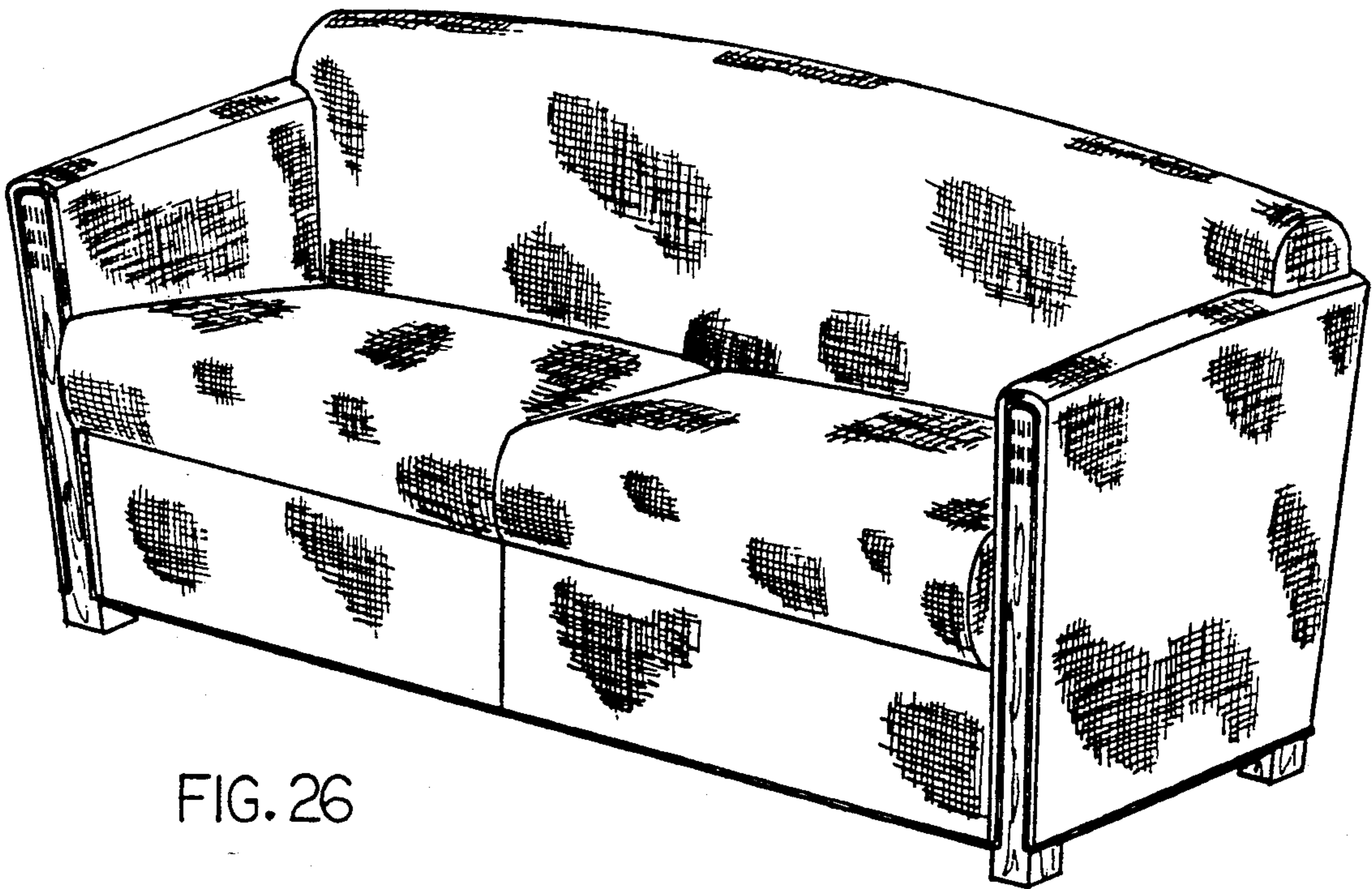

FIG. 26