



US00D329519S

United States Patent [19]
Holloway, Jr.

[11] **Patent Number: Des. 329,519**

[45] **Date of Patent: ** Sep. 15, 1992**

[54] **RAMP**

[76] **Inventor: Kermit Holloway, Jr., Rte. 1 Box
117-E, Oakvale, Miss. 39656**

[**] **Term: 14 Years**

[21] **Appl. No.: 544,354**

[22] **Filed: Jun. 27, 1990**

[52] **U.S. Cl. D34/32**

[58] **Field of Search D34/32; D12/53;
414/537; 193/41; 119/82; 105/436; 14/69.5**

[56] **References Cited**

U.S. PATENT DOCUMENTS

D. 264,199	5/1982	Wood	D34/32
3,517,791	6/1970	Miles	193/41
4,601,632	7/1986	Agee	414/537

FOREIGN PATENT DOCUMENTS

255353	10/1959	Australia	14/69.5
763647	7/1967	Canada	14/69.5

Primary Examiner—Wallace R. Burke

Assistant Examiner—H. Baynham

Attorney, Agent, or Firm—Leon Gilden

[57] **CLAIM**

The ornamental design for a ramp, as shown and described.

DESCRIPTION

FIG. 1 is a front elevational view of the ramp showing my new design;

FIG. 2 is a rear elevational view thereof;

FIG. 3 is a left side elevational view thereof;

FIG. 4 is a right side elevational view thereof;

FIG. 5 is a top plan view thereof;

FIG. 6 is a bottom plan view thereof; and,

FIG. 7 is a perspective view thereof.

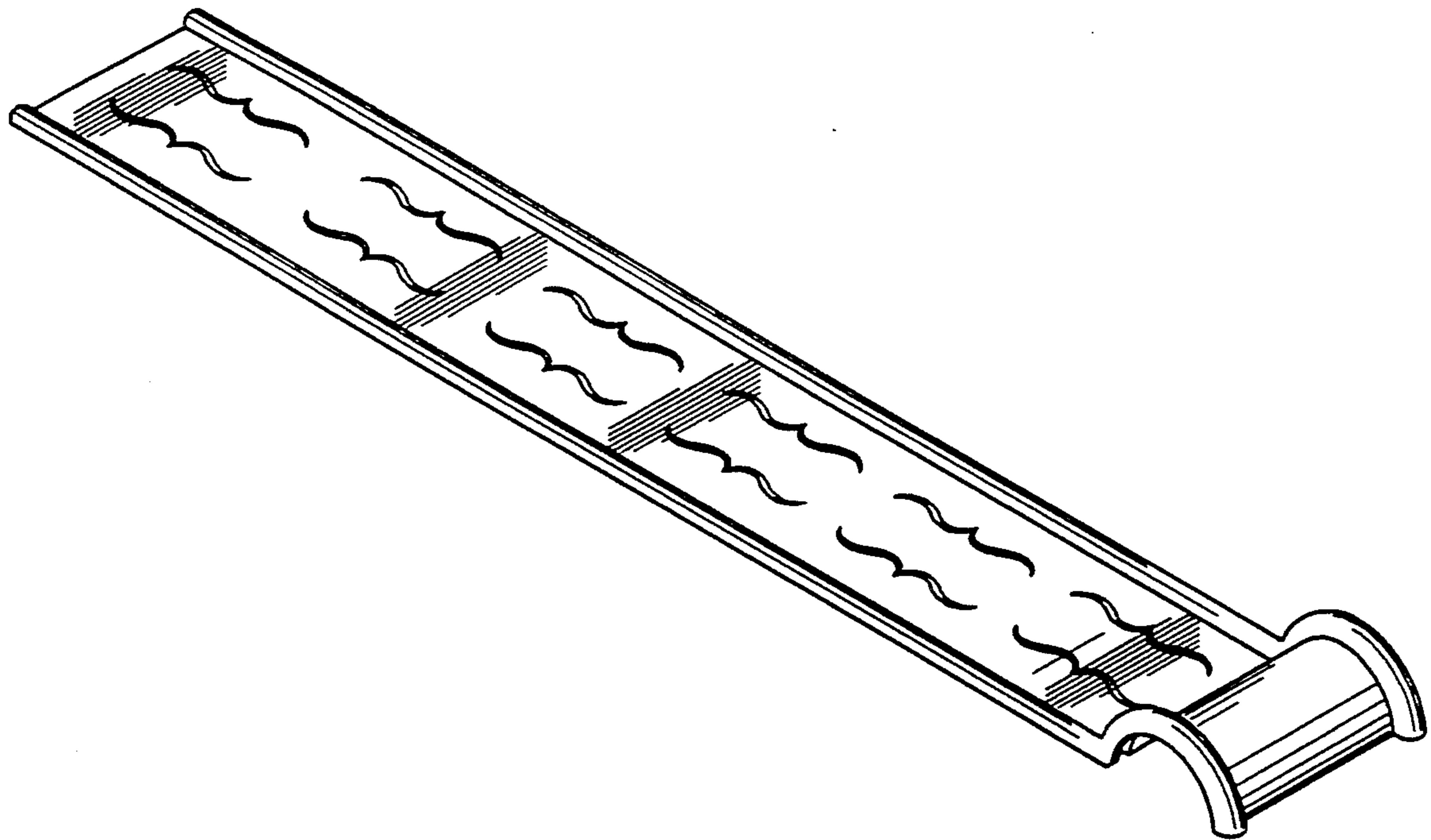

FIG. 1

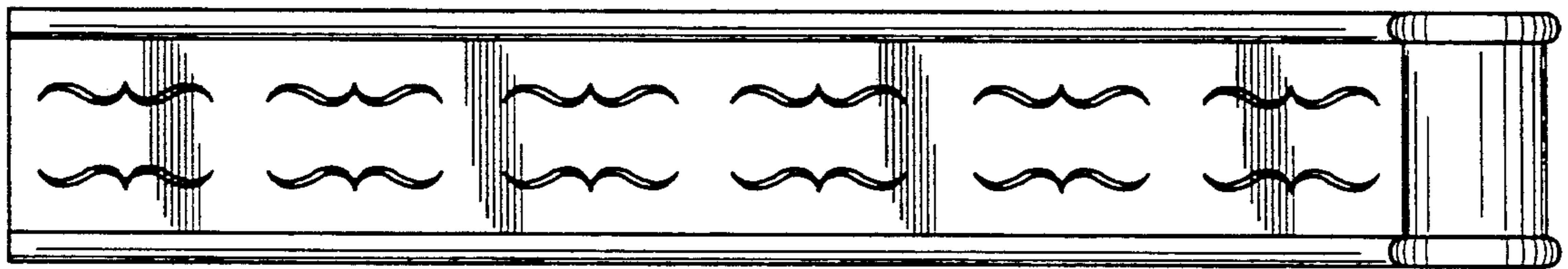

FIG. 2

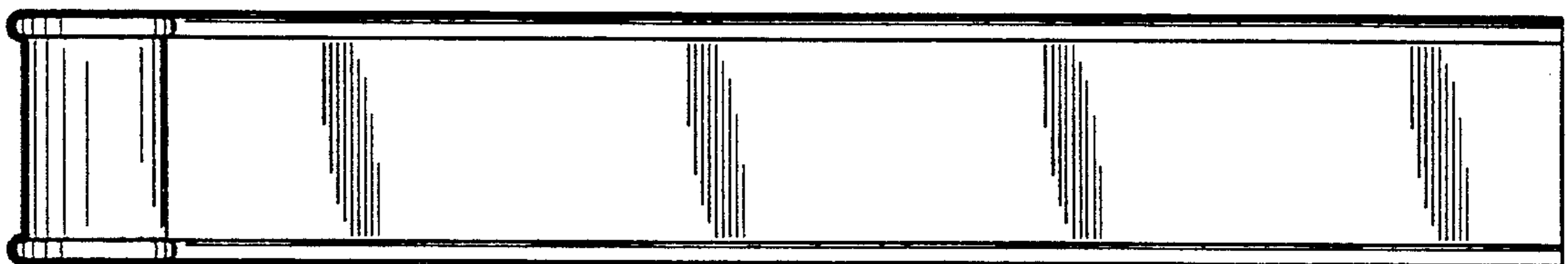

FIG. 3

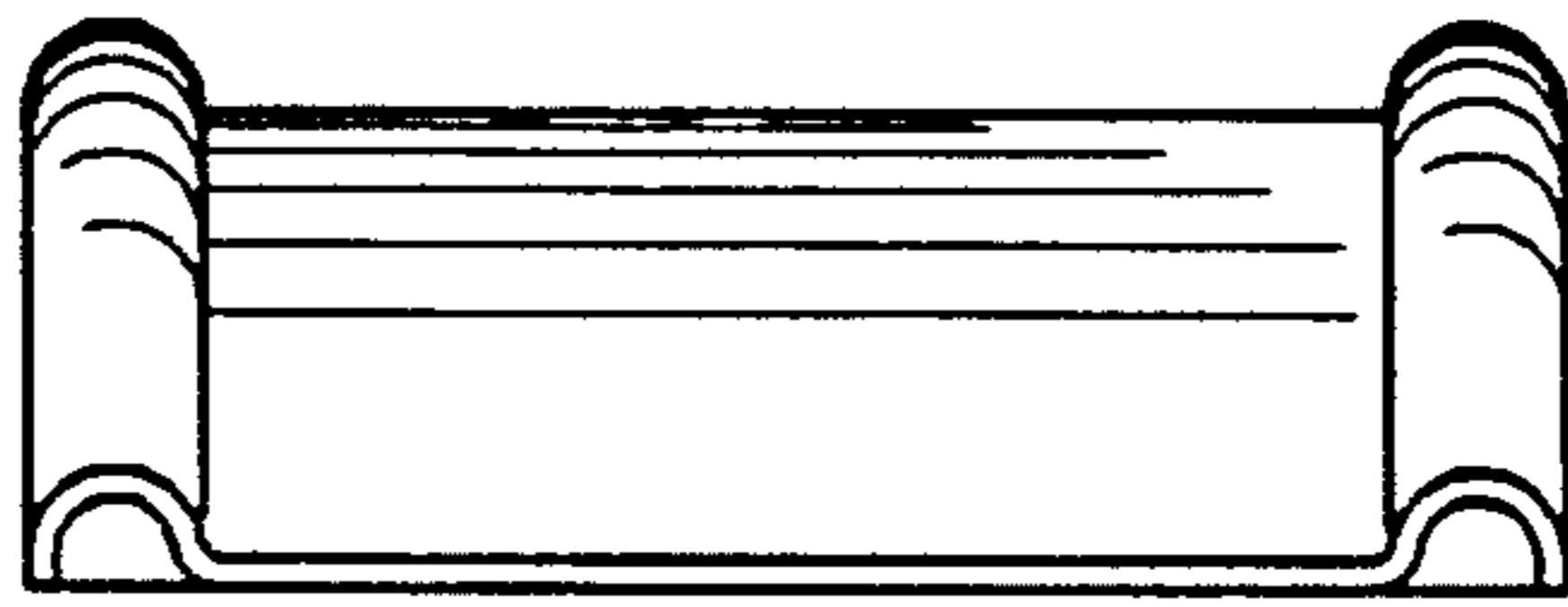

FIG. 4

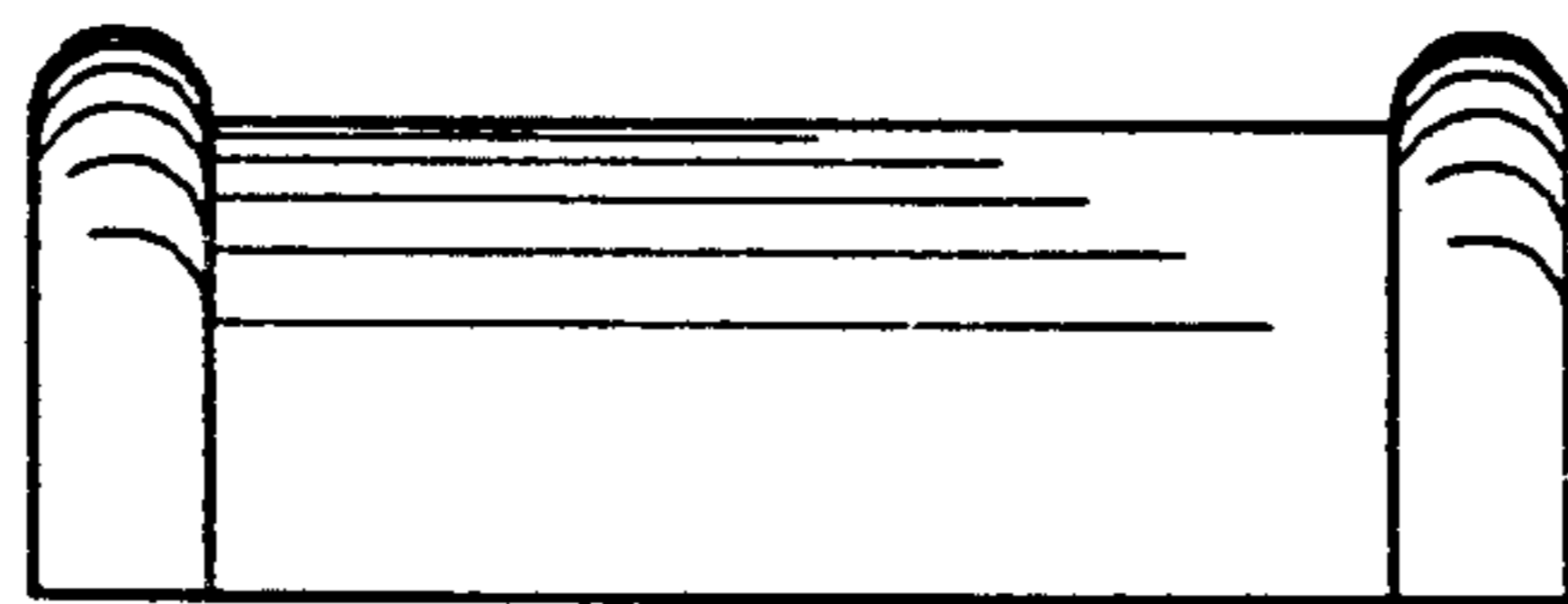

FIG. 5

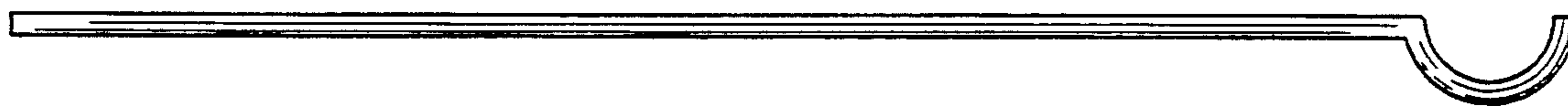

FIG. 6

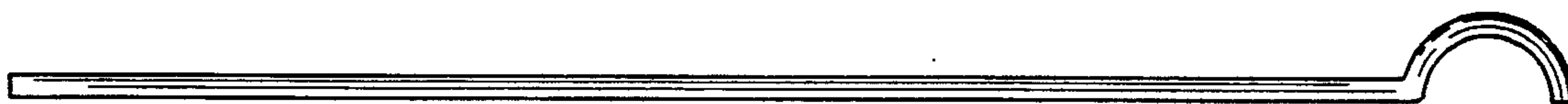

FIG. 7

