



US00D329514S

United States Patent [19]

[11] Patent Number: **Des. 329,514**

Isaac

[45] Date of Patent: **** Sep. 15, 1992**

- [54] REFUSE CONTAINER COVER
- [76] Inventor: **Mimi Isaac**, 7855 Birchmont Dr.,
University City, Mo. 63130
- [**] Term: **14 Years**
- [21] Appl. No.: **372,949**
- [22] Filed: **Jun. 28, 1989**
- [52] U.S. Cl. **D34/4; D34/1;
D6/610**
- [58] Field of Search **D34/1, 4; D6/523, 610;
150/154-167**

2,704,563 3/1955 Henrich 150/159
 4,947,794 8/1990 Baldwin 150/154

Primary Examiner—Kay H. Chin
Attorney, Agent, or Firm—Heller & Kepler

[57] **CLAIM**

The ornamental design for a refuse container cover, as shown and described.

DESCRIPTION

FIG. 1 is a top and front perspective view of a refuse container cover showing my new design;
 FIG. 2 is a top and rear perspective view thereof;
 FIG. 3 is a top plan view thereof;
 FIG. 4 is a front elevational view thereof;
 FIG. 5 is a rear elevational thereof; and,
 FIG. 6 is a side elevational view thereof, the opposite side view being a mirror image of that shown.

- [56] **References Cited**
- U.S. PATENT DOCUMENTS**
- D. 213,884 4/1969 Warnberg D6/523
 - D. 214,288 5/1969 Warnberg D6/610

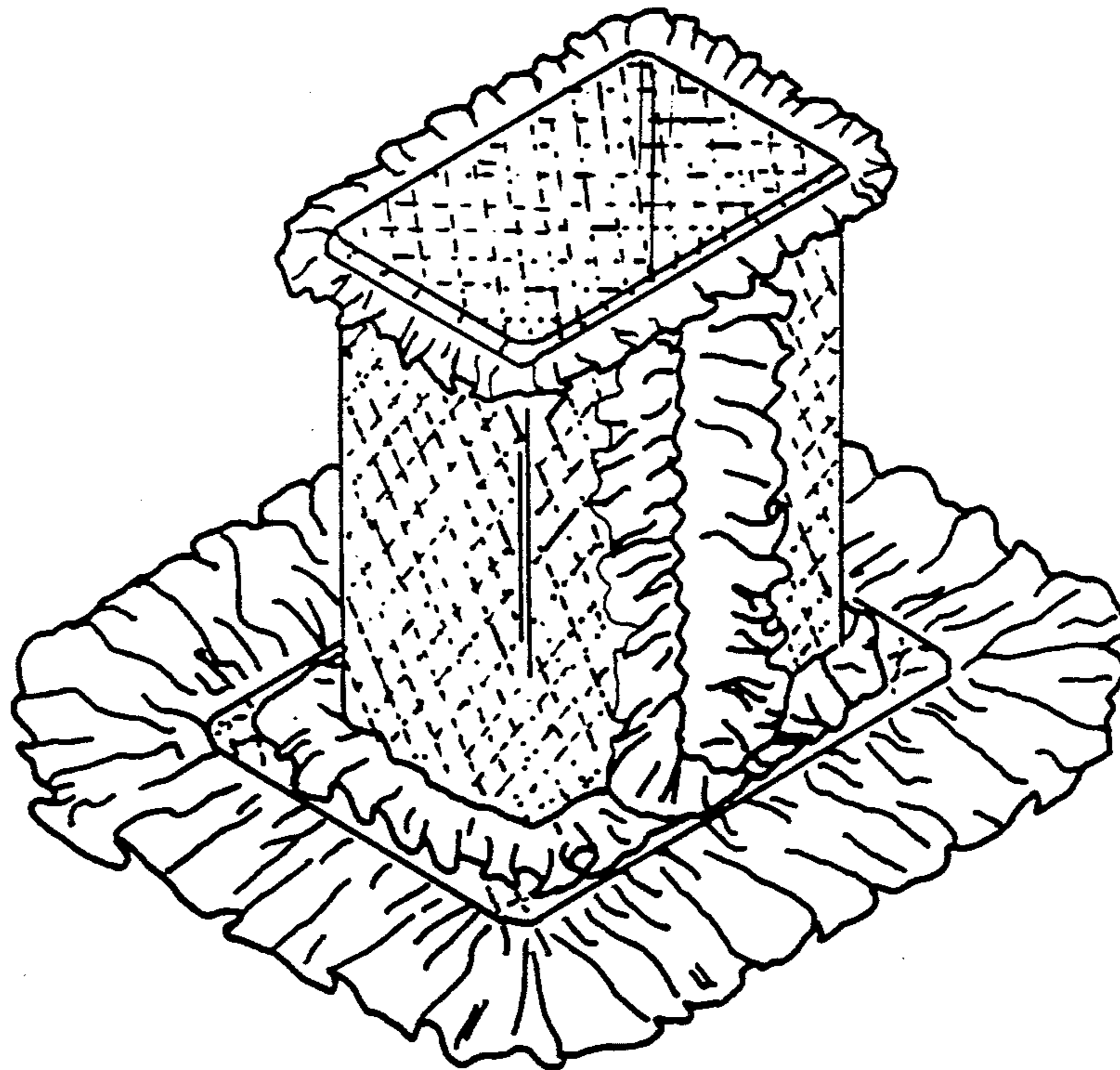

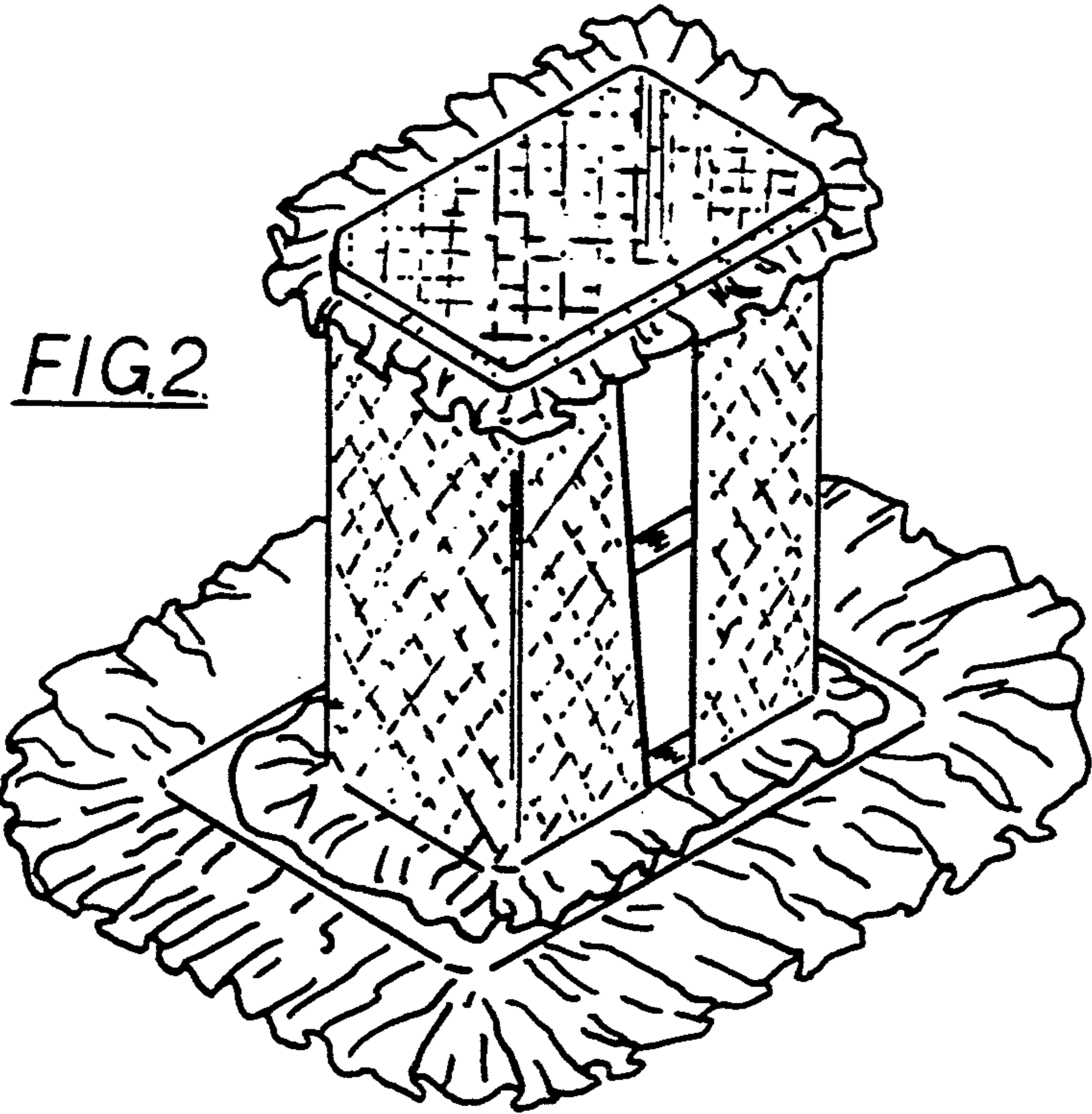
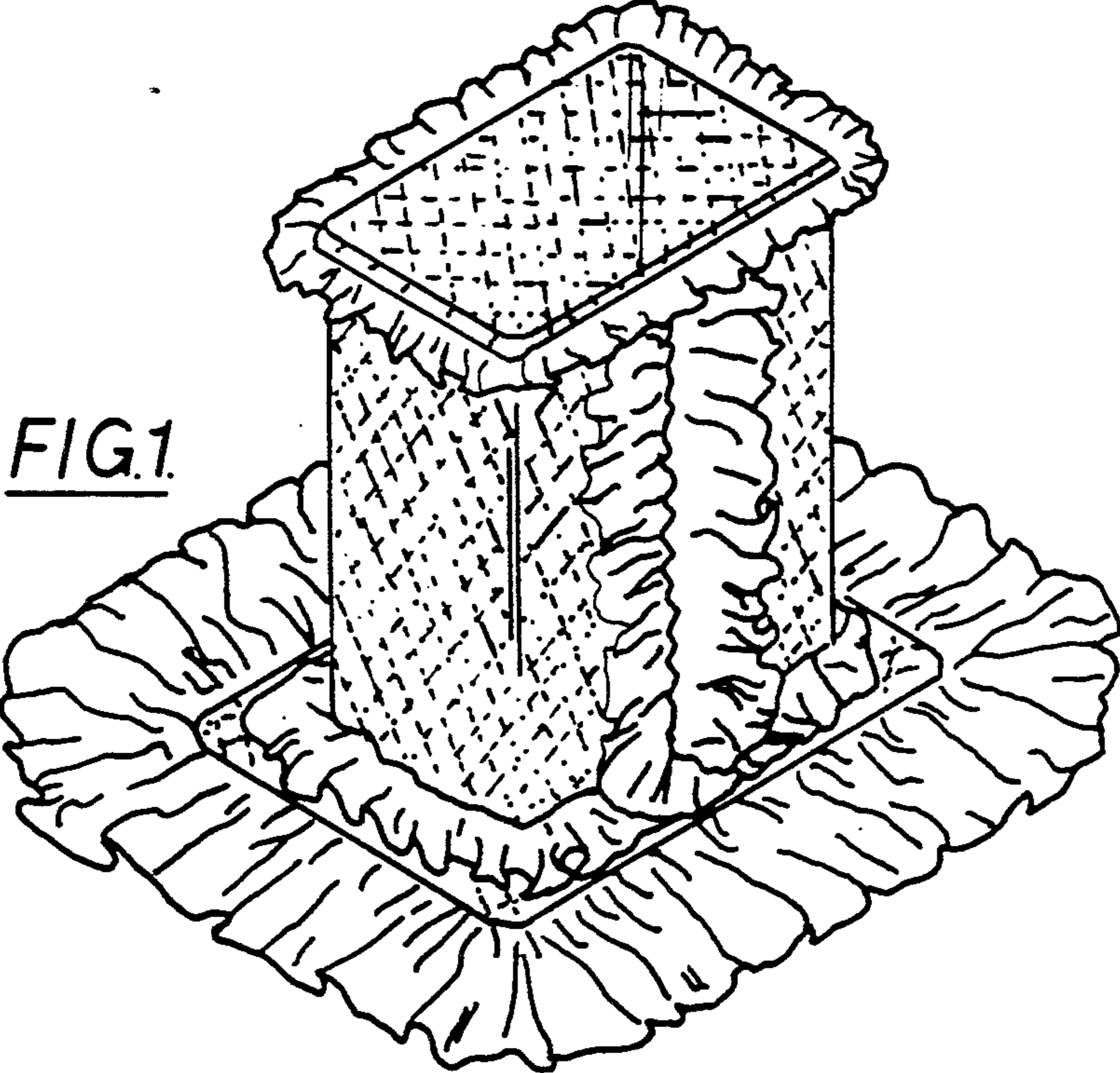

FIG.3.

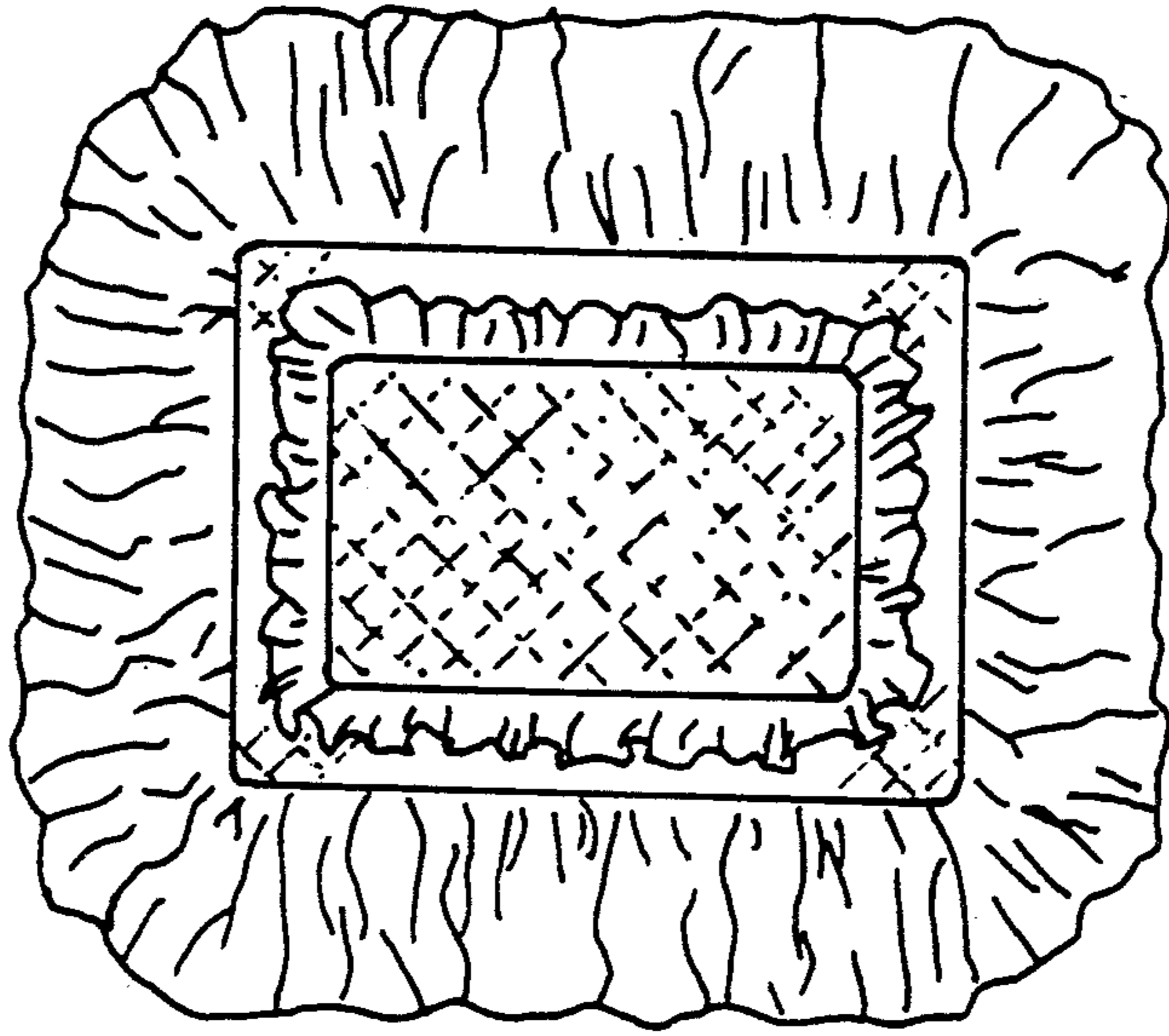

FIG.4.

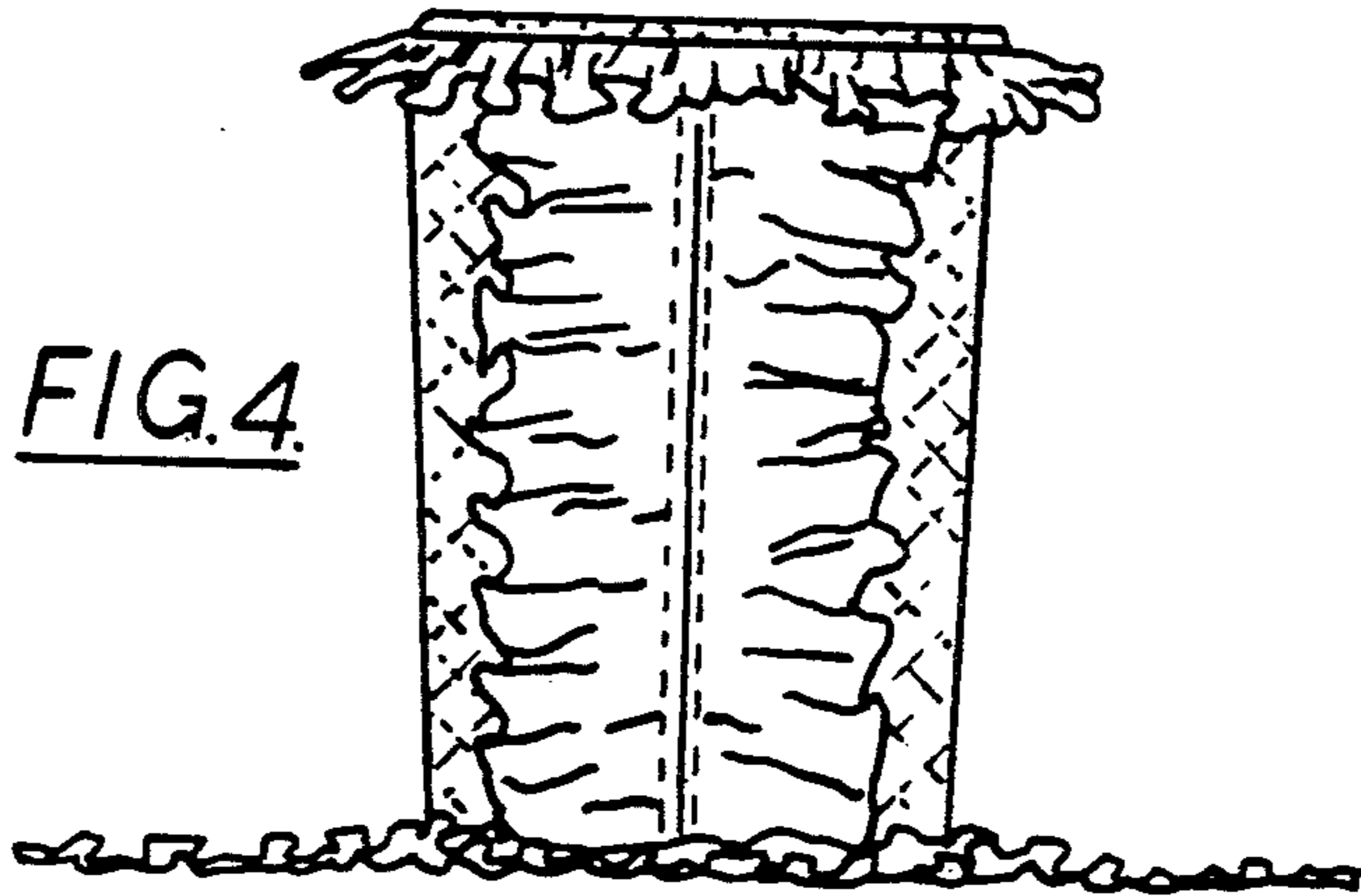
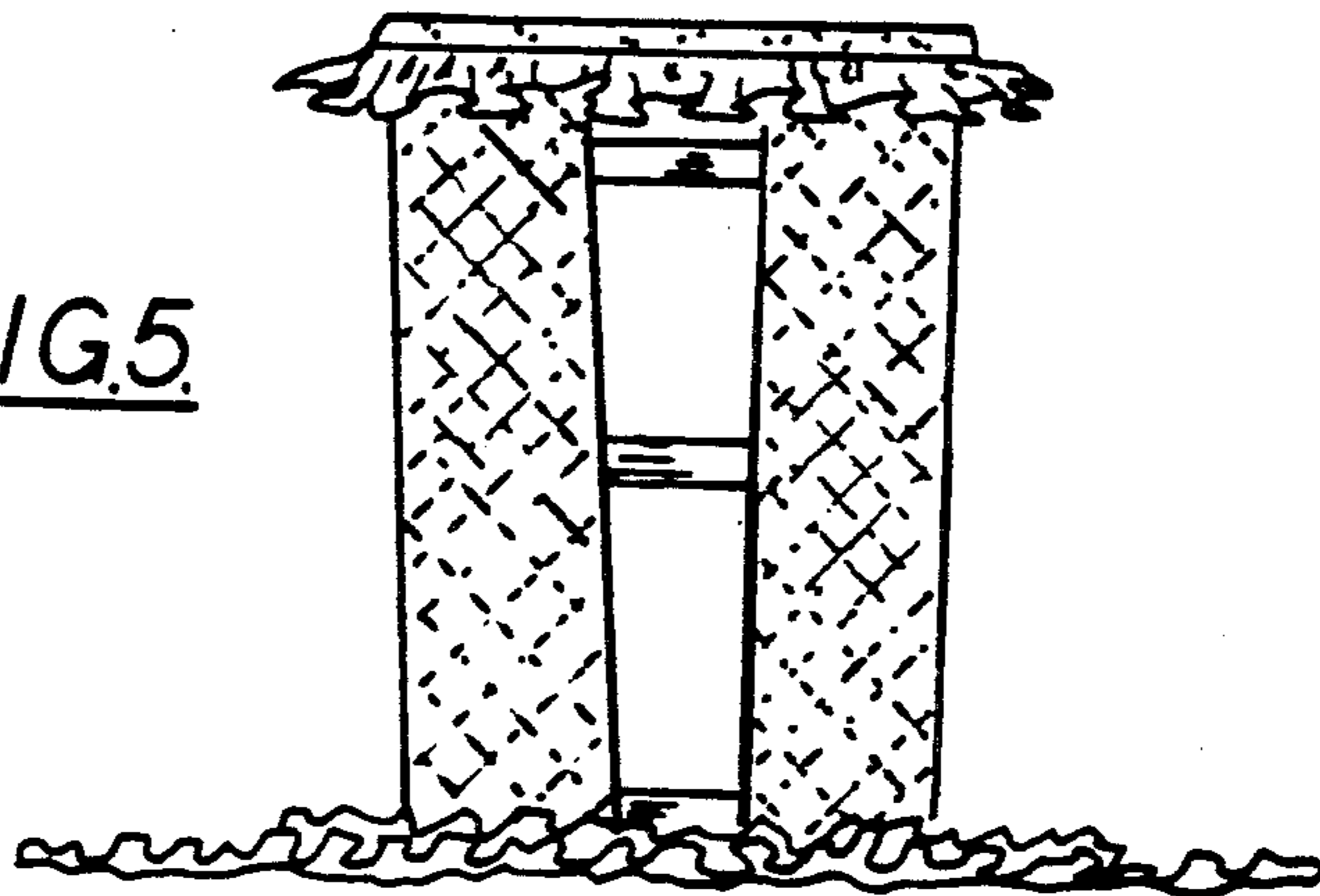

FIG.5.



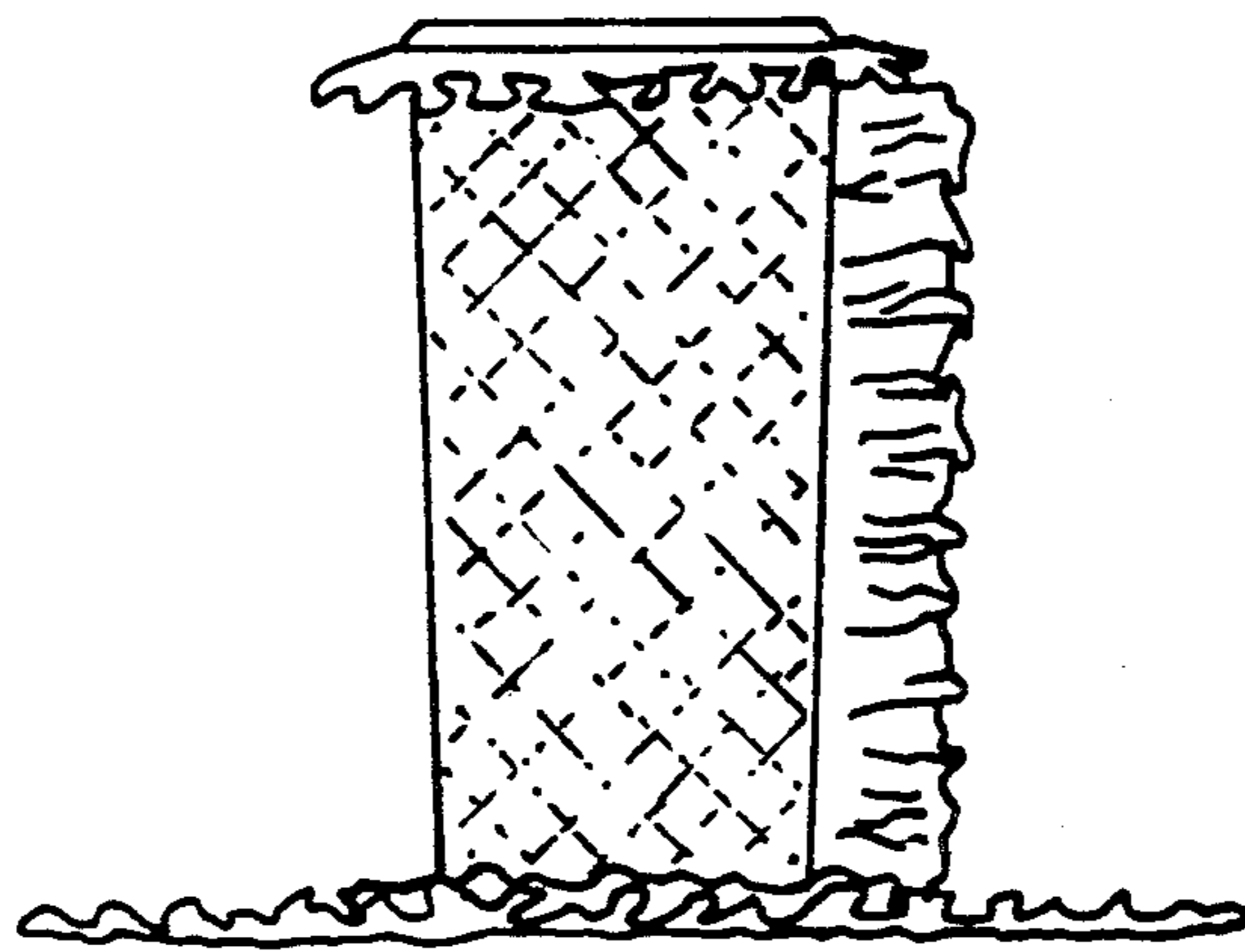

FIG. 6.