



US00D329462S

United States Patent [19]

[11] Patent Number: **Des. 329,462**

Bain

[45] Date of Patent: **** Sep. 15, 1992**

[54] **TAPE DISPENSER**

D. 298,042 10/1988 Szablak D19/67
2,305,592 12/1942 Anderson D19/69 X

[76] Inventor: **Charles E. Bain**, 210 N. 3rd. St., West Dundee, Ill. 60118

Primary Examiner—Nelson C. Holtje
Assistant Examiner—Martha Thompson

[**] Term: **14 Years**

[57] **CLAIM**

[21] Appl. No.: **511,593**

The ornamental design for a tape dispenser, as shown and described.

[22] Filed: **Apr. 17, 1990**

[52] U.S. Cl. **D19/69; D19/67**

[58] Field of Search D19/65, 67, 68, 69, D19/99, 100; 225/6, 19, 34, 45, 56, 65, 77, 89; 156/523, 527, 526, 384, 510

DESCRIPTION

FIG. 1 is a top, left front perspective view of a tape dispenser showing my new design; FIG. 2 is a top plan view thereof; FIG. 3 is a left side elevational view thereof; FIG. 4 is a right side elevational view thereof; FIG. 5 is a bottom plan view thereof; FIG. 6 is a front elevational view thereof; and, FIG. 7 is a rear elevational view thereof. FIGS. 2 through 7 have been drawn to a reduced scale with respect to FIG. 1.

[56] **References Cited**

U.S. PATENT DOCUMENTS

D. 109,930	5/1938	Reinecke	D19/69
D. 169,989	7/1953	Reinecke	D19/69
D. 270,649	9/1983	Evenson	D19/69
D. 297,548	9/1988	Sun	D19/69

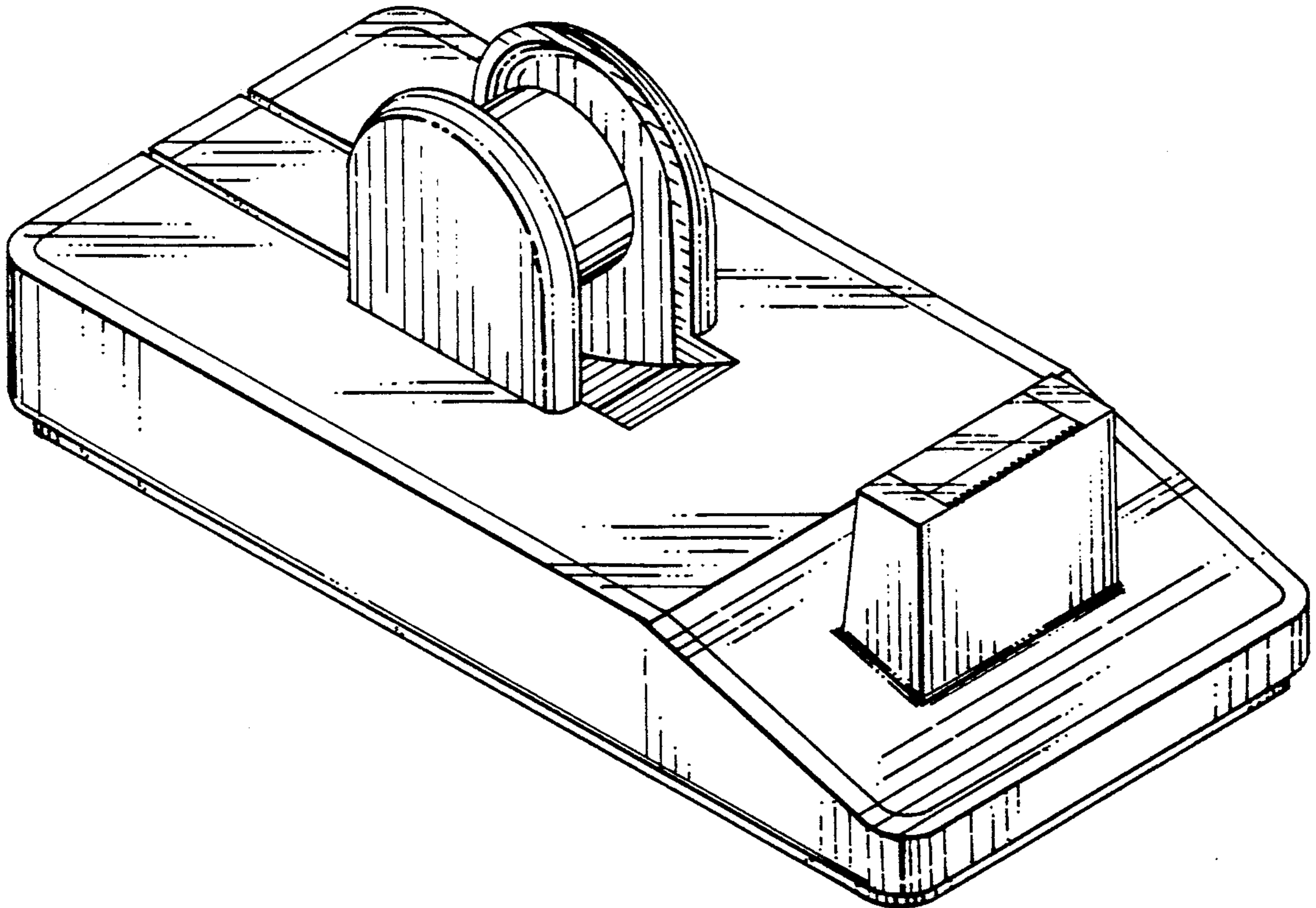
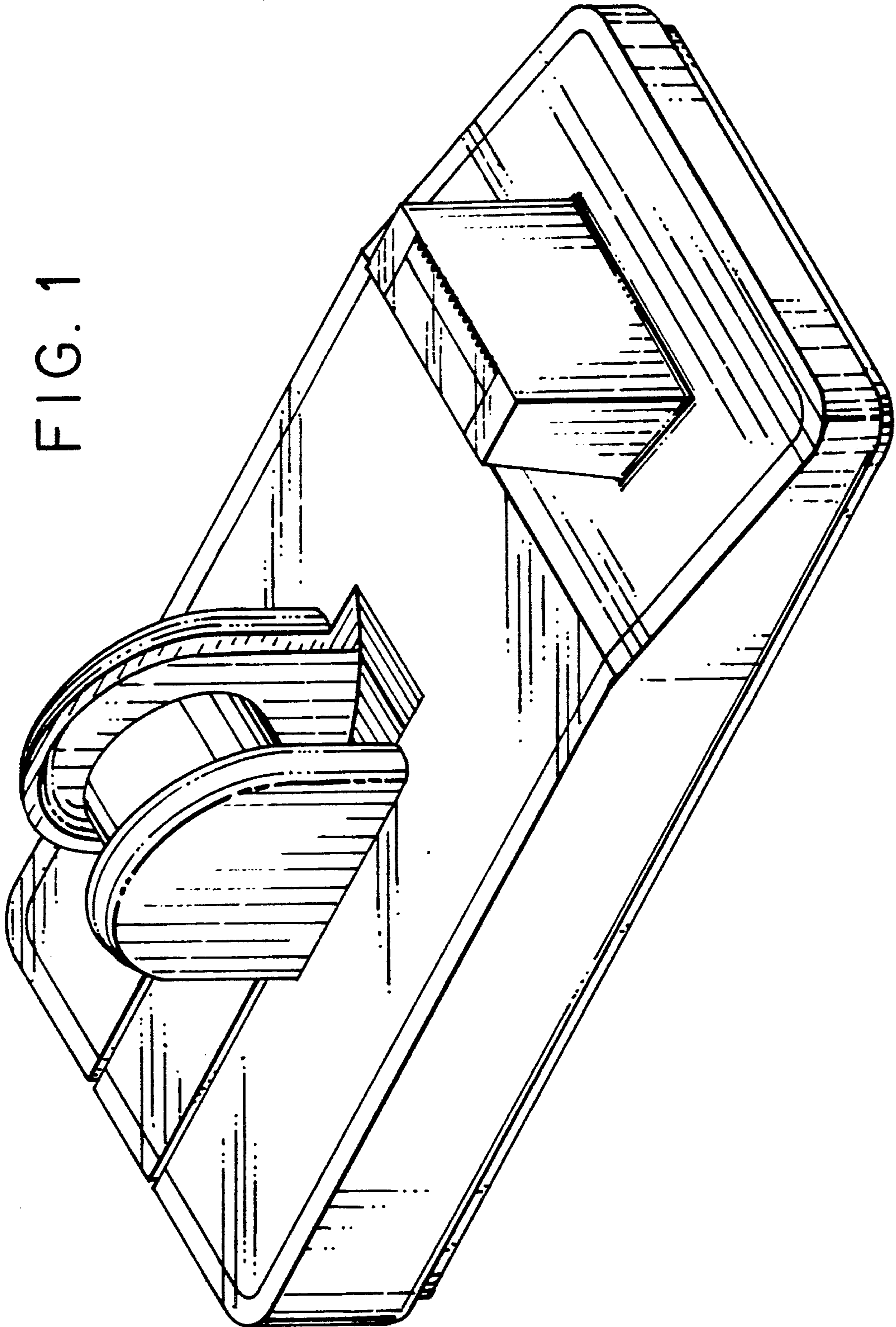

FIG. 1



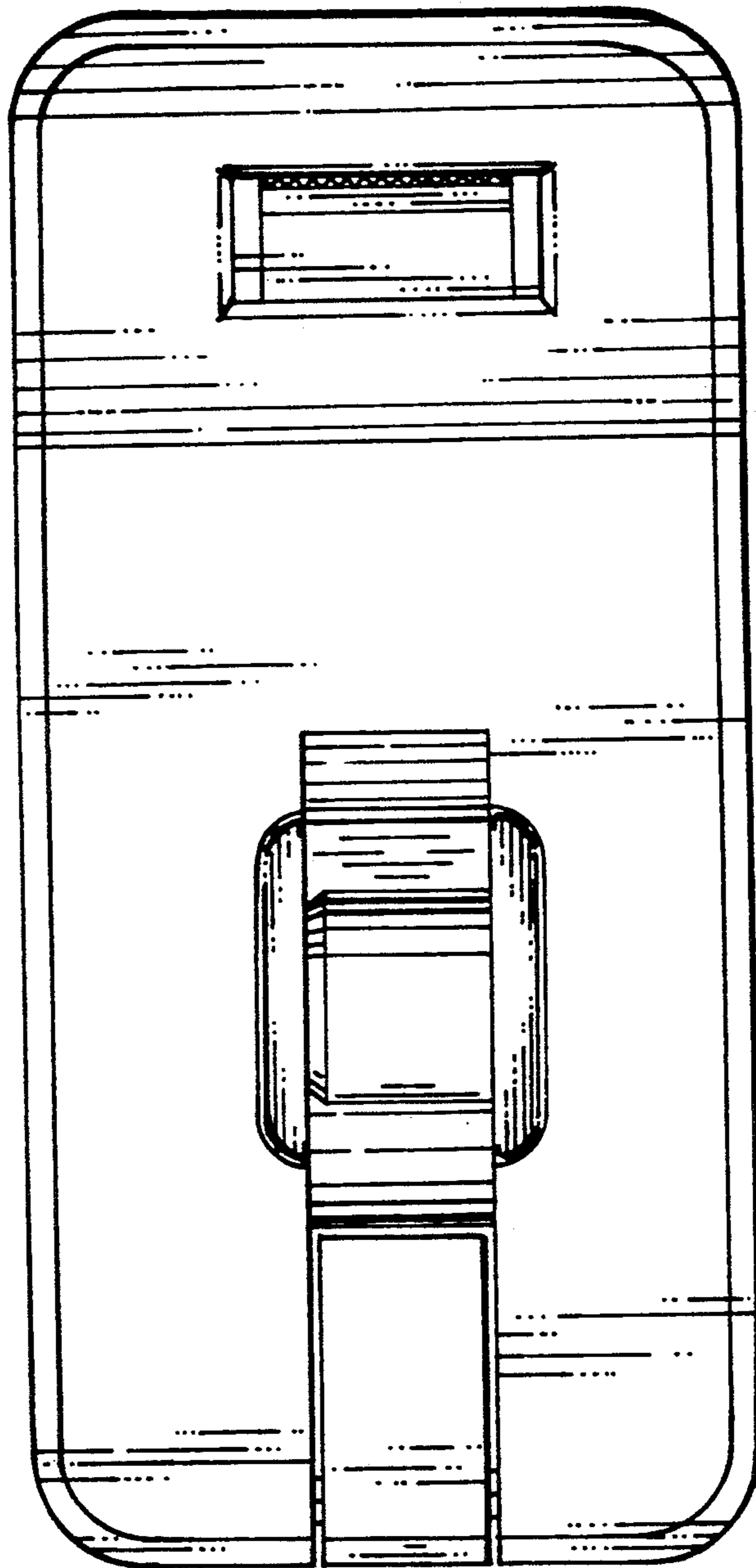

FIG. 2

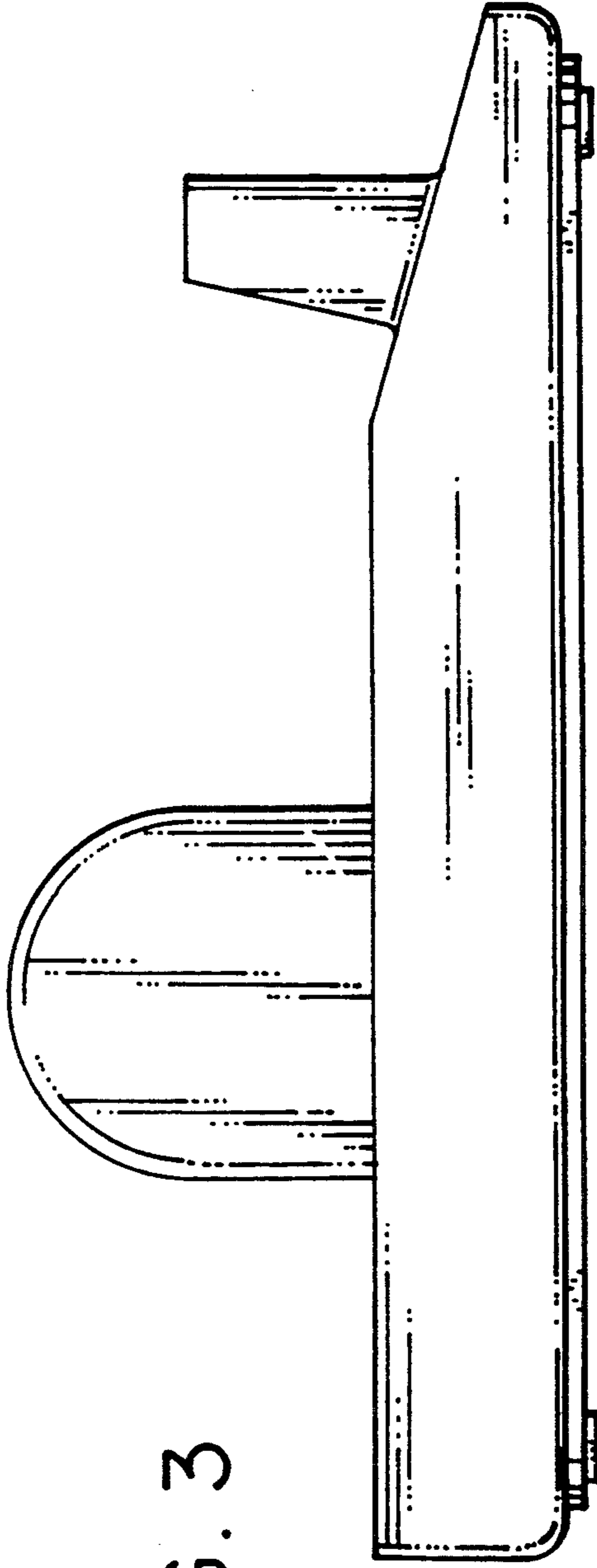

FIG. 3

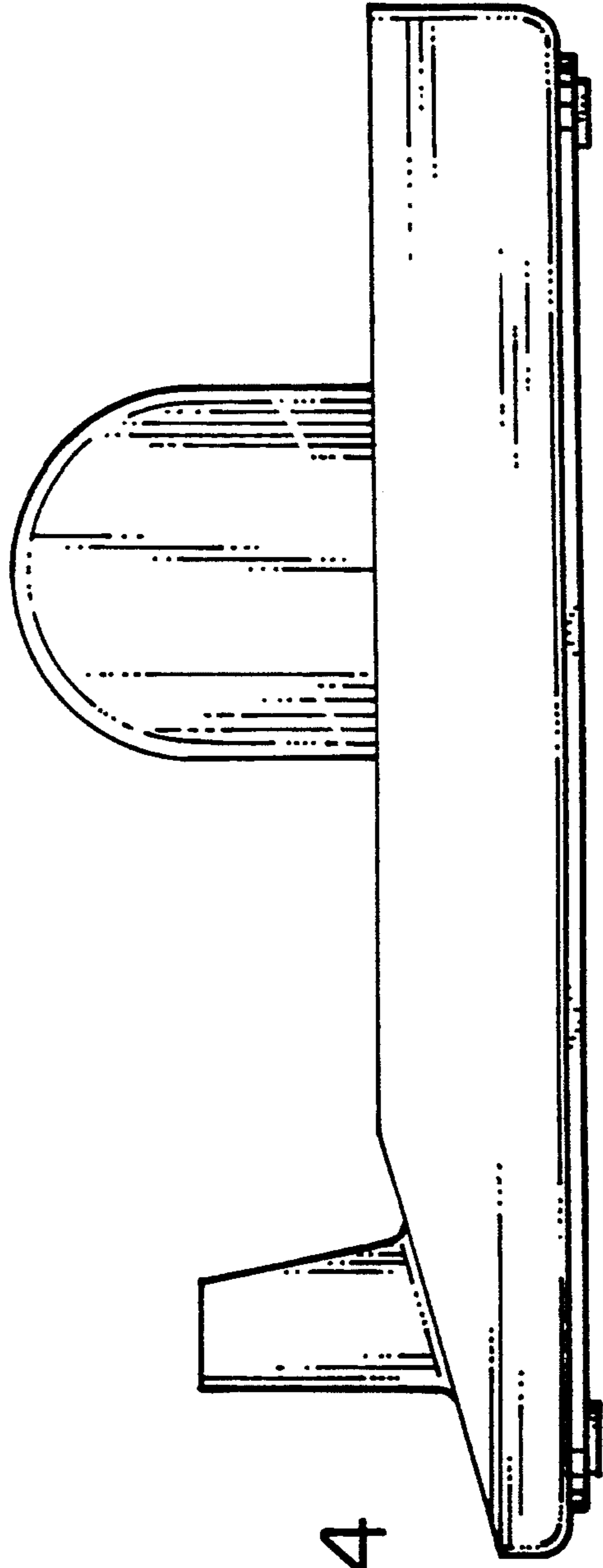

FIG. 4

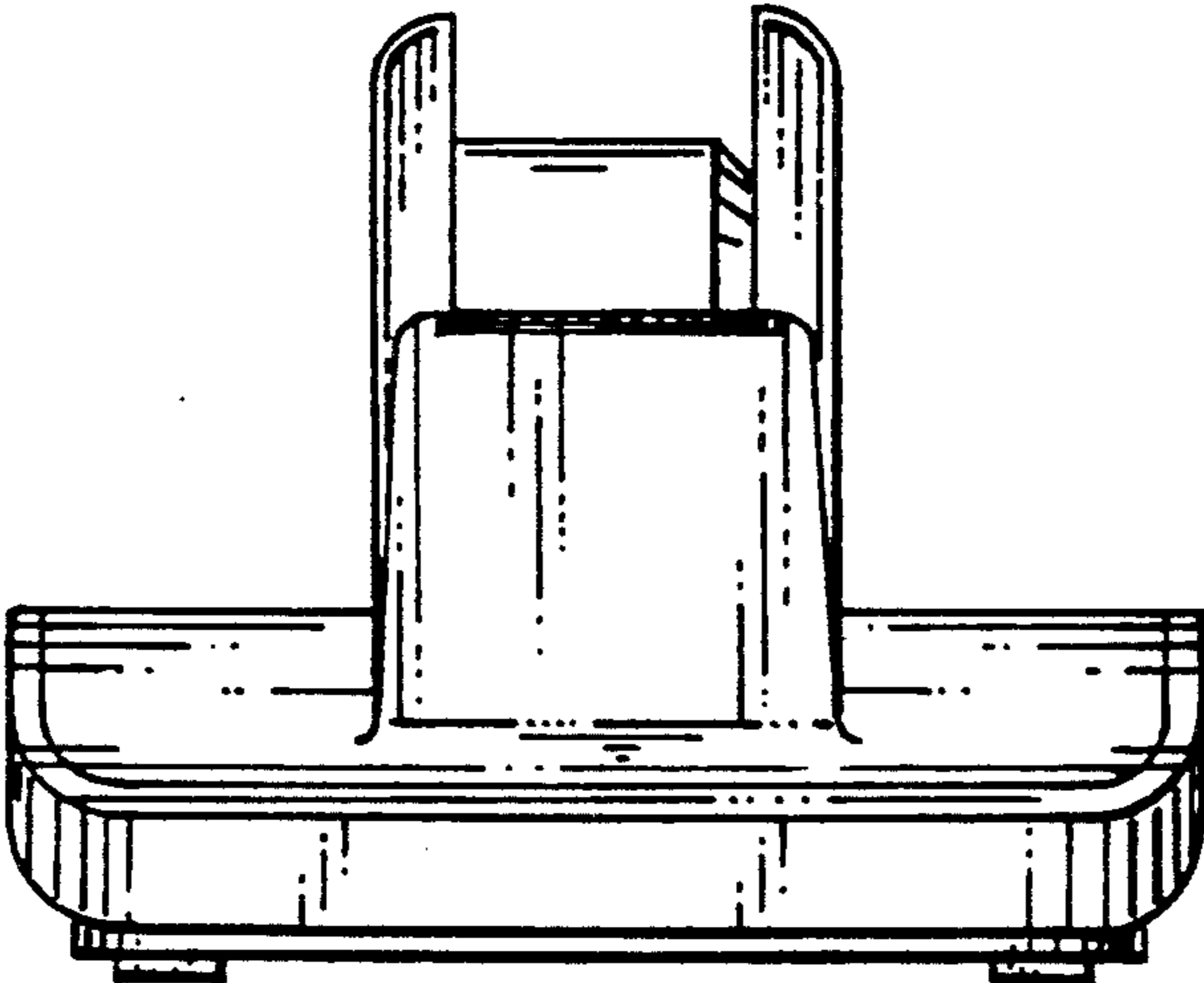

FIG. 5

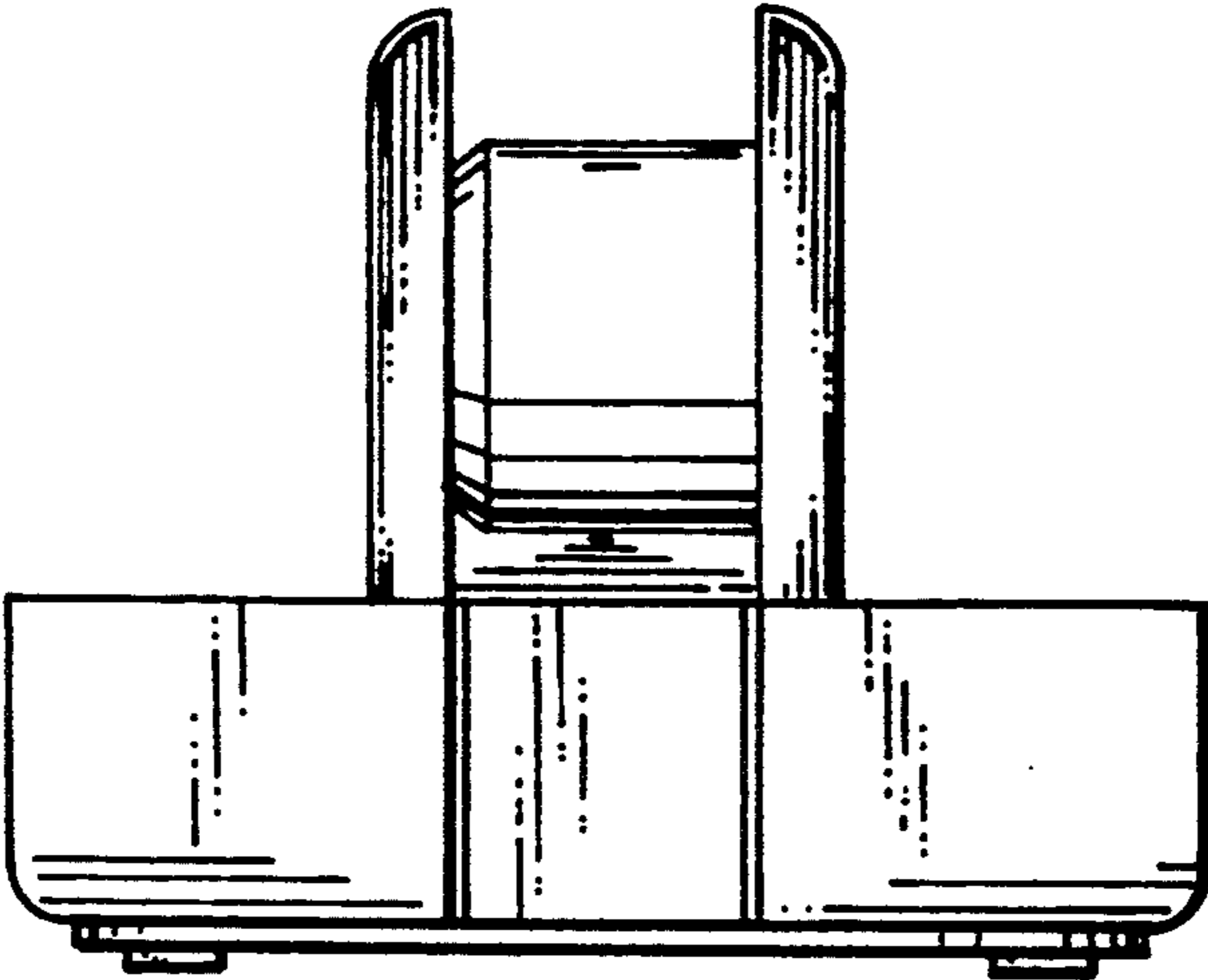

FIG. 6

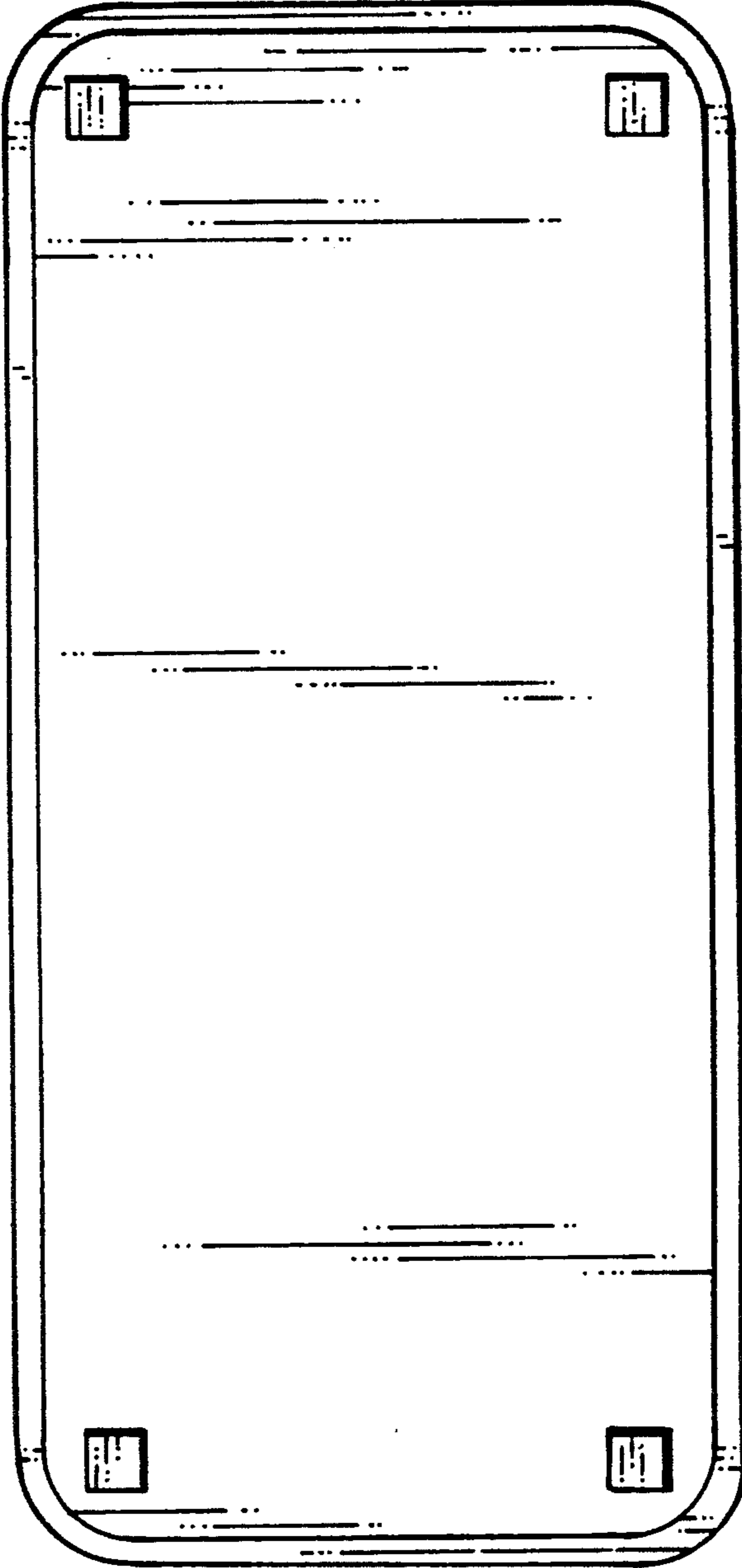

FIG. 7