



US00D329456S

United States Patent [19]

[11] Patent Number: **Des. 329,456**

Kamezaki

[45] Date of Patent: **** Sep. 15, 1992**

[54] **AUTO DOCUMENT FEEDER**

[75] Inventor: **Yasushi Kamezaki**, Osaka, Japan

[73] Assignee: **Mita Industrial Co., Ltd.**, Osaka, Japan

[**] Term: **14 Years**

[21] Appl. No.: **584,965**

[22] Filed: **Sep. 19, 1990**

[30] **Foreign Application Priority Data**

Mar. 20, 1990 [JP] Japan 2-9333

Jun. 1, 1990 [JP] Japan 2-18615

[52] U.S. Cl. **D18/49; D18/46**

[58] Field of Search **D18/36-40, D18/46, 49; 271/3, 3.1, 8.1, 9; 355/200, 308, 309; 358/498**

[56] **References Cited**

U.S. PATENT DOCUMENTS

D. 276,238 11/1984 Kosako et al. D18/49

D. 313,618 1/1991 Kosako et al. D18/49

D. 315,363 3/1991 Kosako et al. D18/39

D. 316,268 4/1991 Miyajima et al. D18/49

4,775,139 10/1988 Honjo et al. D18/49 X

Primary Examiner—Donald P. Walsh
Assistant Examiner—Caron D. Veynar
Attorney, Agent, or Firm—Sughrue, Mion, Zinn, Macpeak & Seas

[57] **CLAIM**

The ornamental design for an auto document feeder, as shown and described.

DESCRIPTION

FIG. 1 is a front, top and left side perspective view of an auto document feeder showing my new design; FIG. 2 is a top plan view thereof; FIG. 3 is a front elevational view thereof; FIG. 4 is a right side elevational view thereof; FIG. 5 is a left side elevational view thereof; FIG. 6 is a rear elevational view thereof; FIG. 7 is a bottom plan view thereof; FIG. 8 is a front, top and left side perspective view of a second embodiment of my new design of FIGS. 1-7; FIG. 9 is a top plan view thereof; FIG. 10 is a front elevational view thereof; FIG. 11 is a right side elevational view thereof; FIG. 12 is a left side elevational view thereof; FIG. 13 is a rear elevational view thereof; and, FIG. 14 is a bottom plan view thereof.

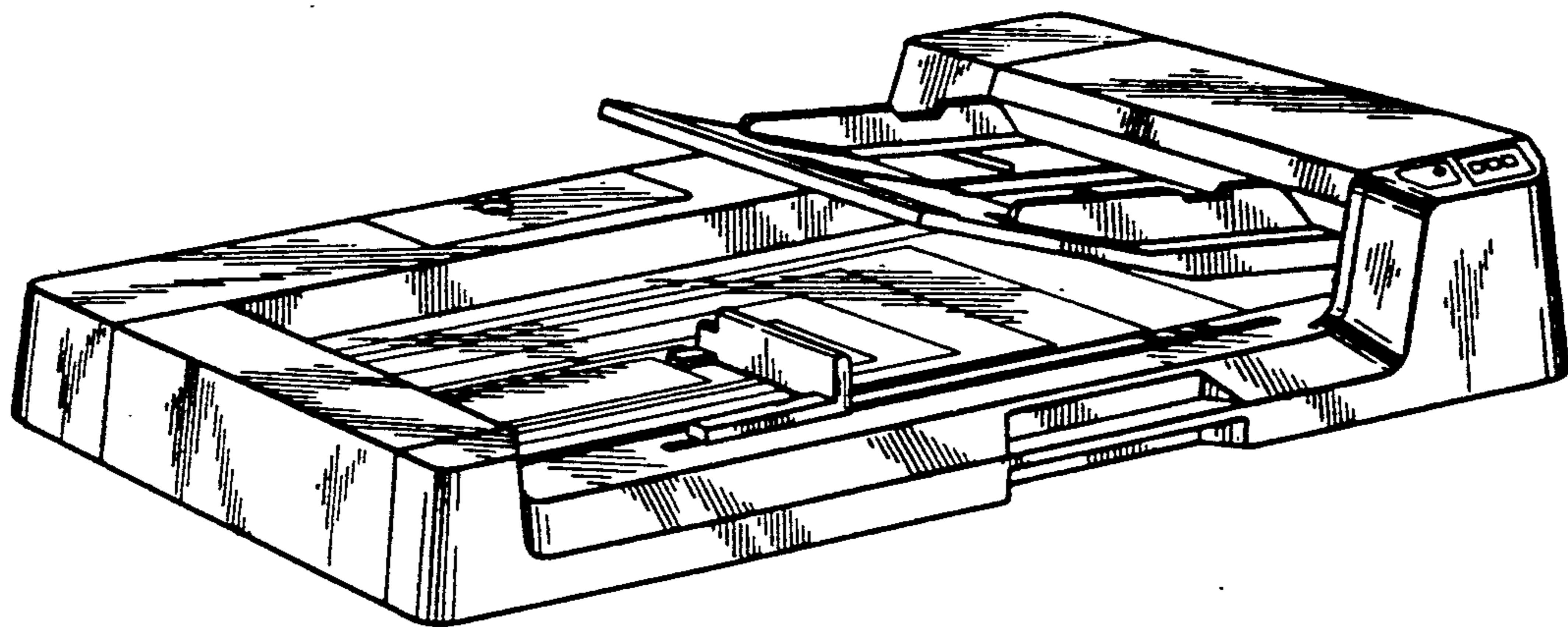
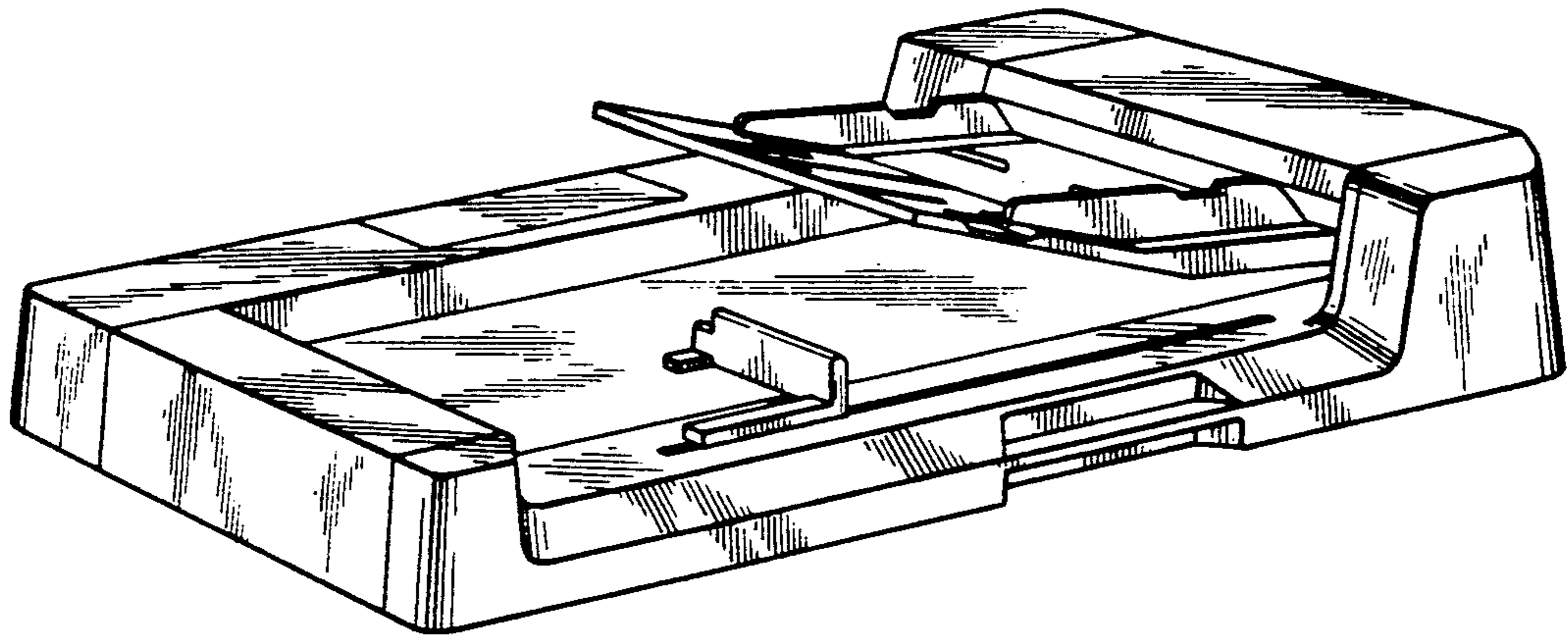

FIG. 1

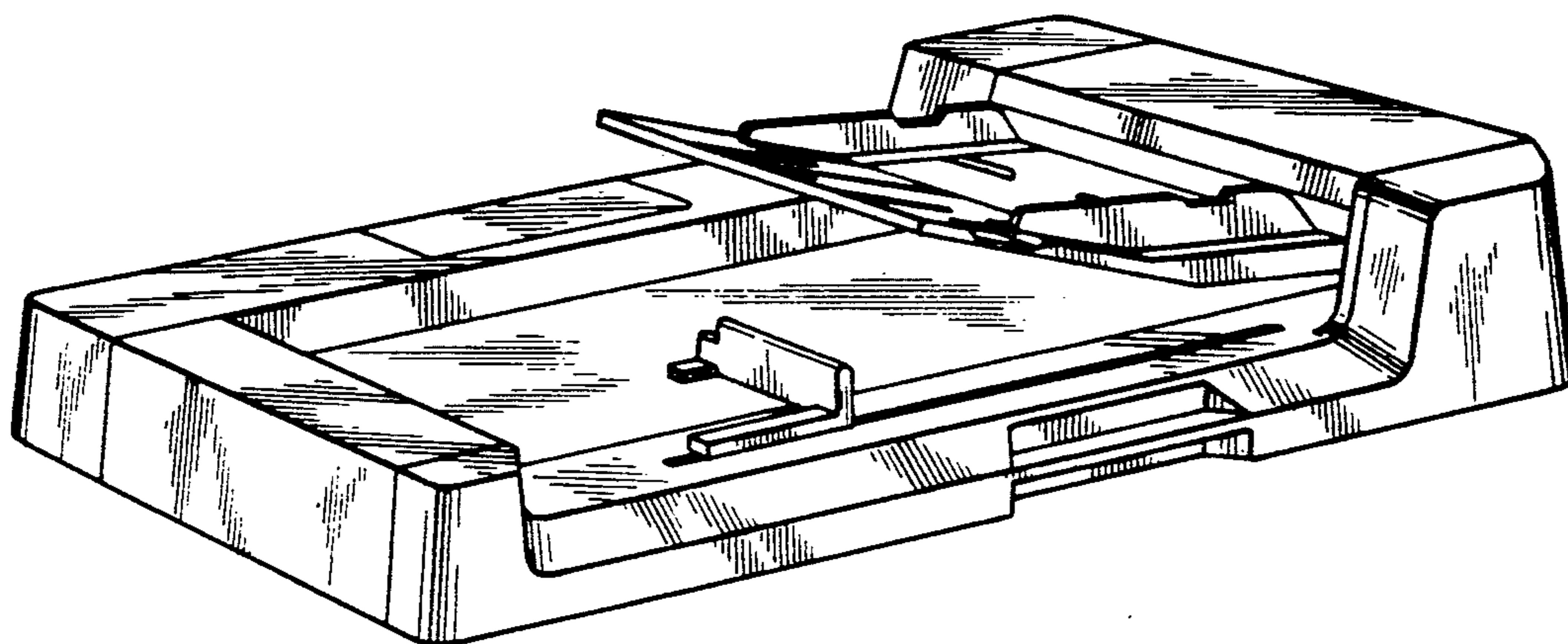

FIG. 2

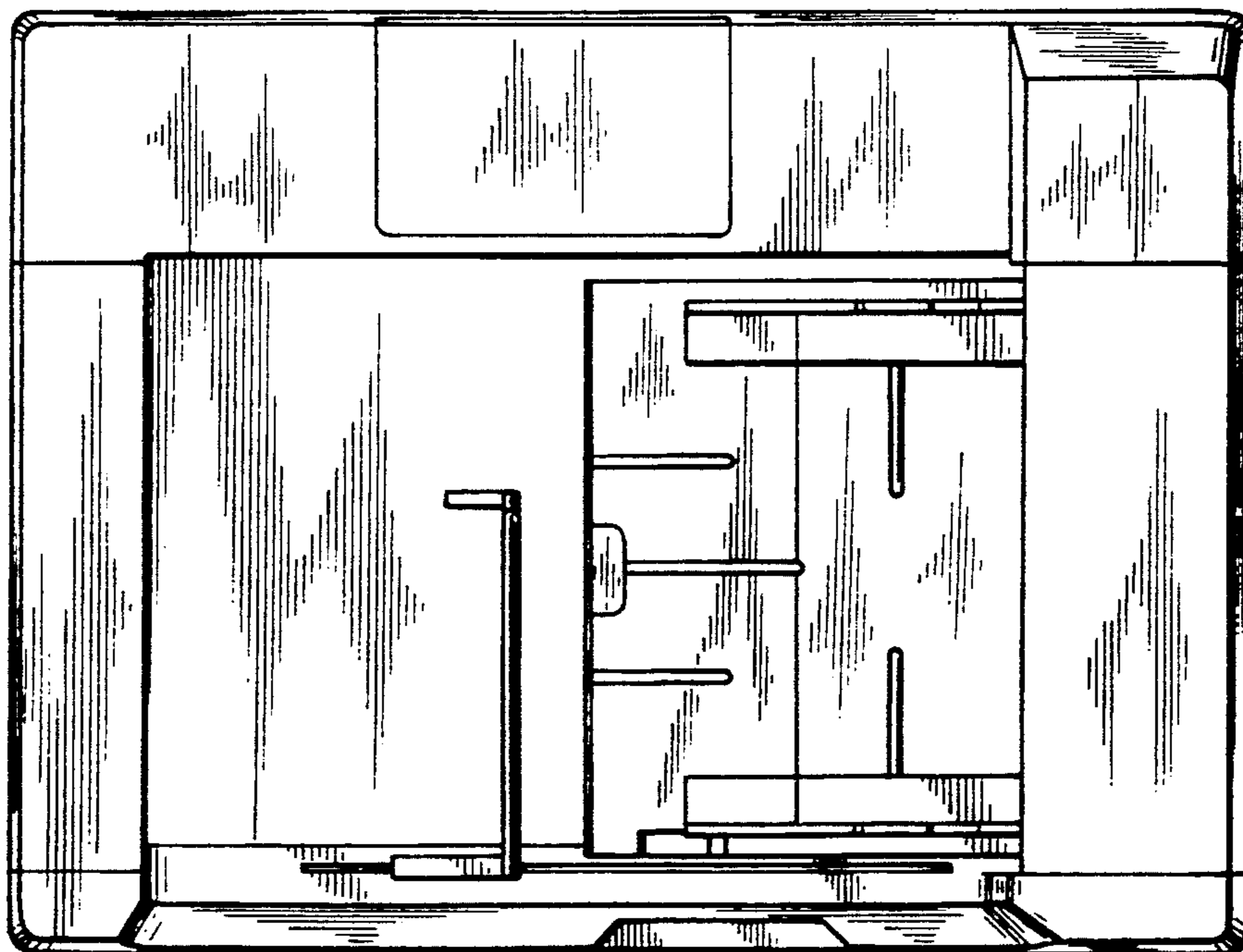

FIG. 3

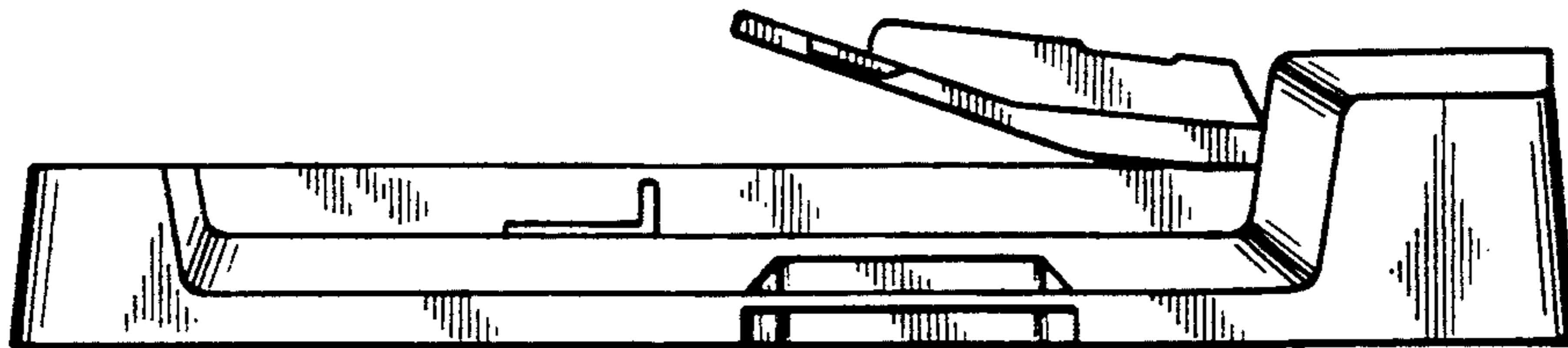

FIG. 4

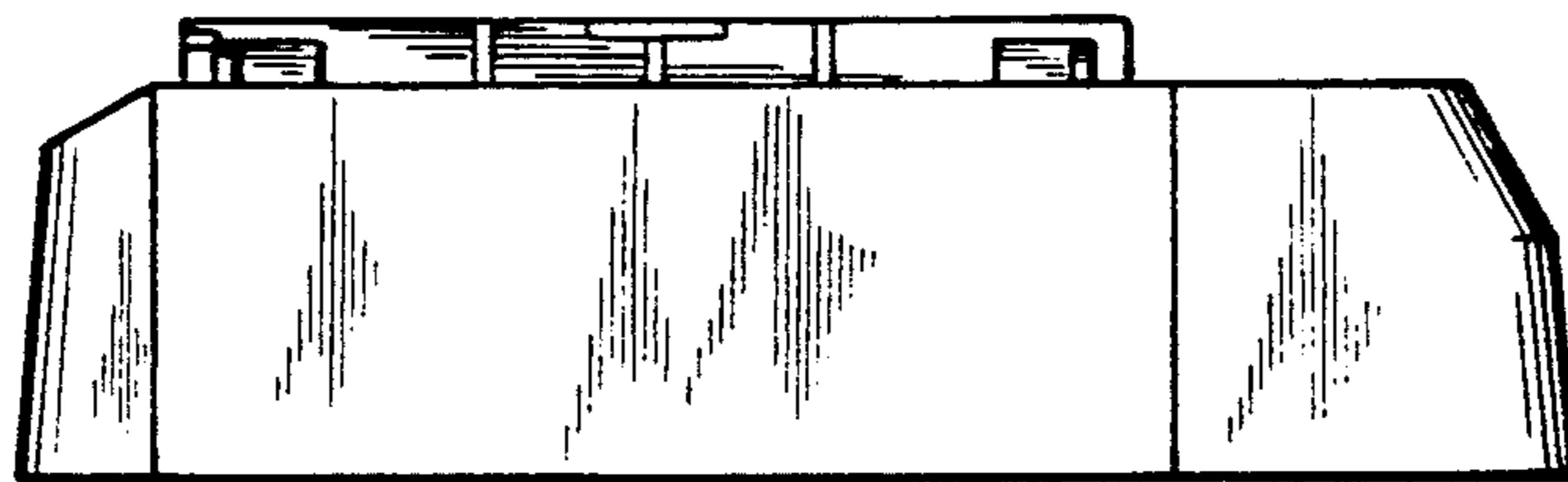

FIG. 5

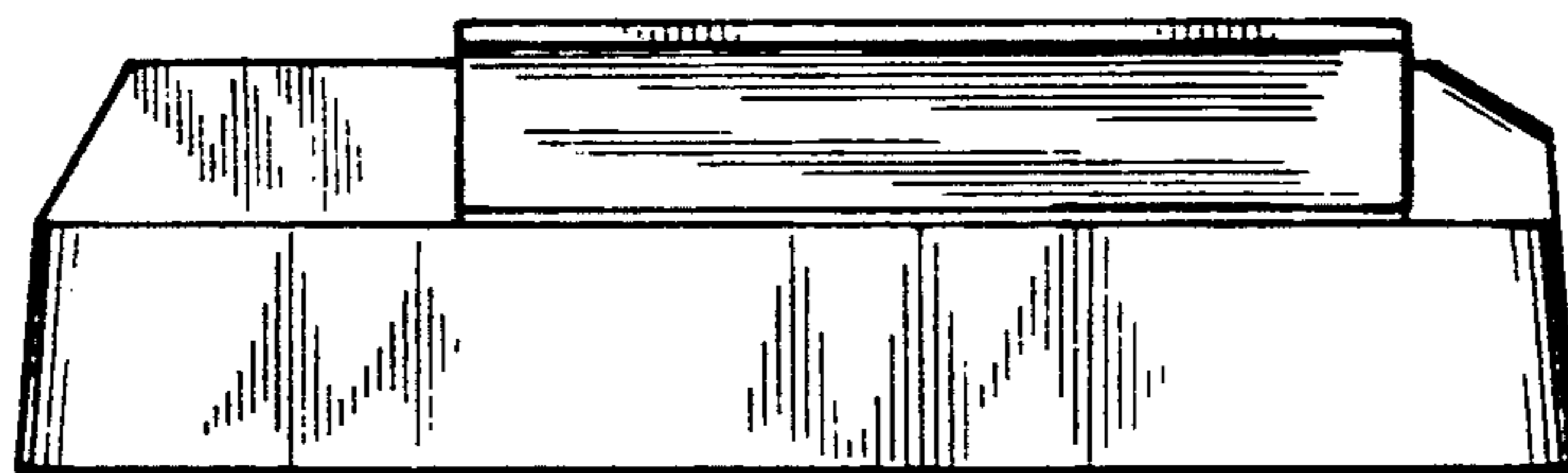

FIG. 6

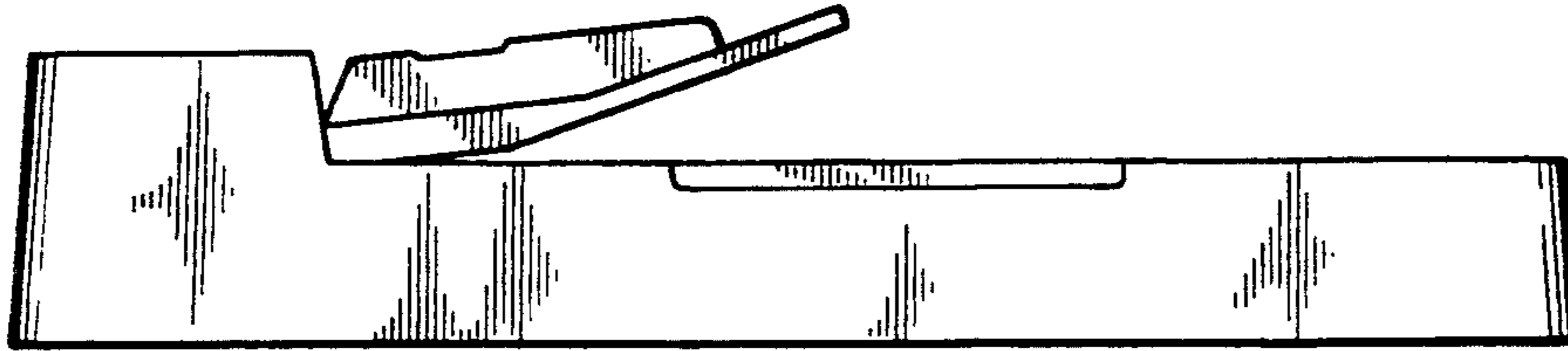

FIG. 7

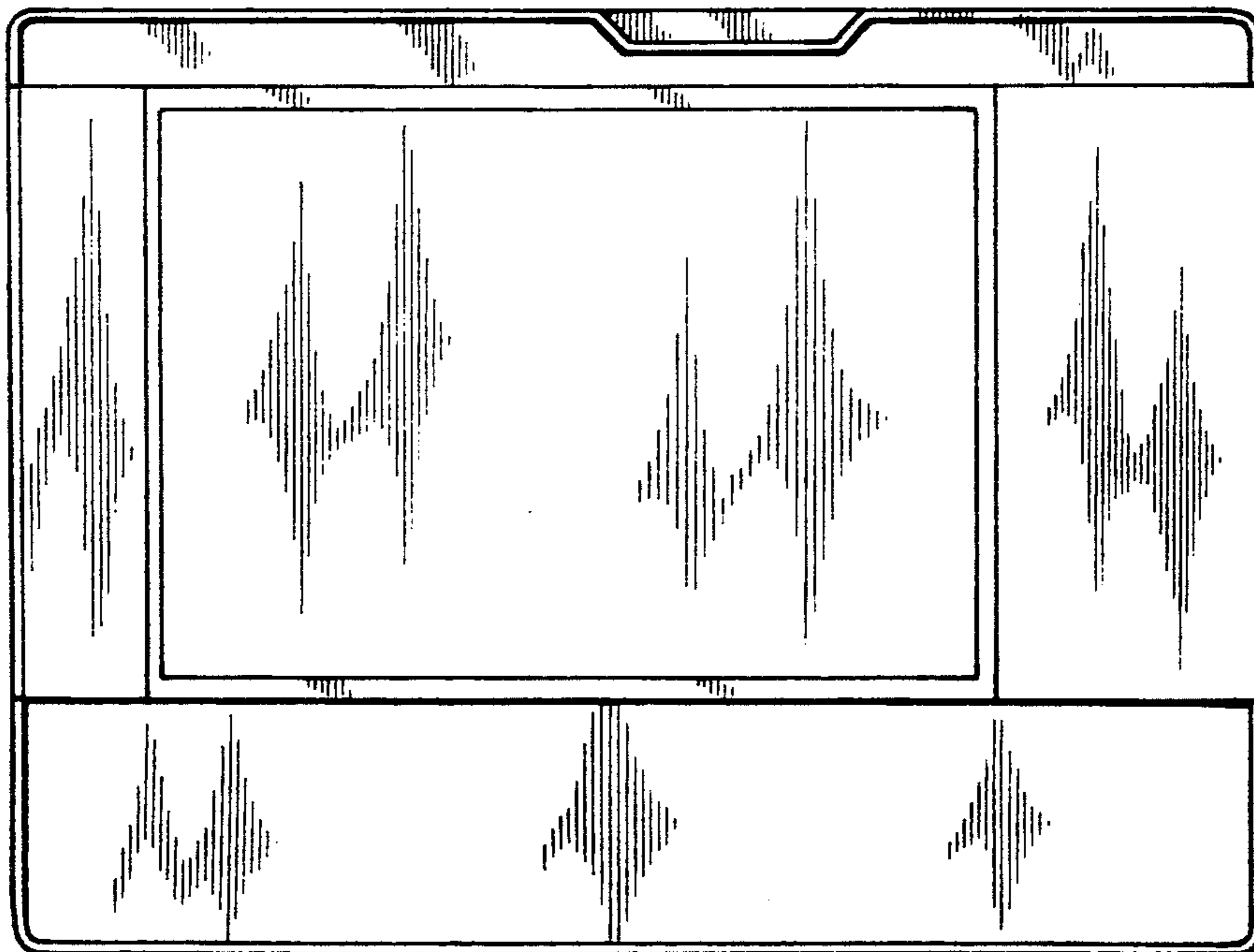

FIG. 8

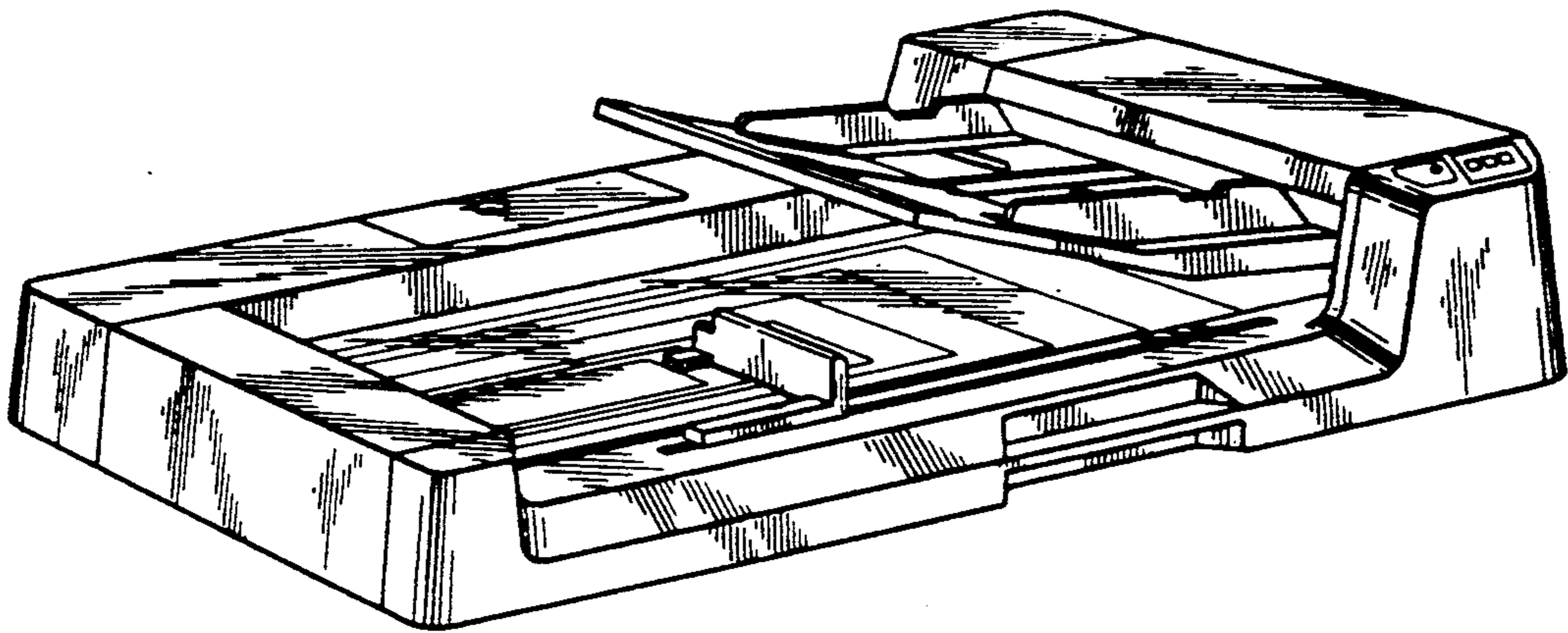

FIG. 9

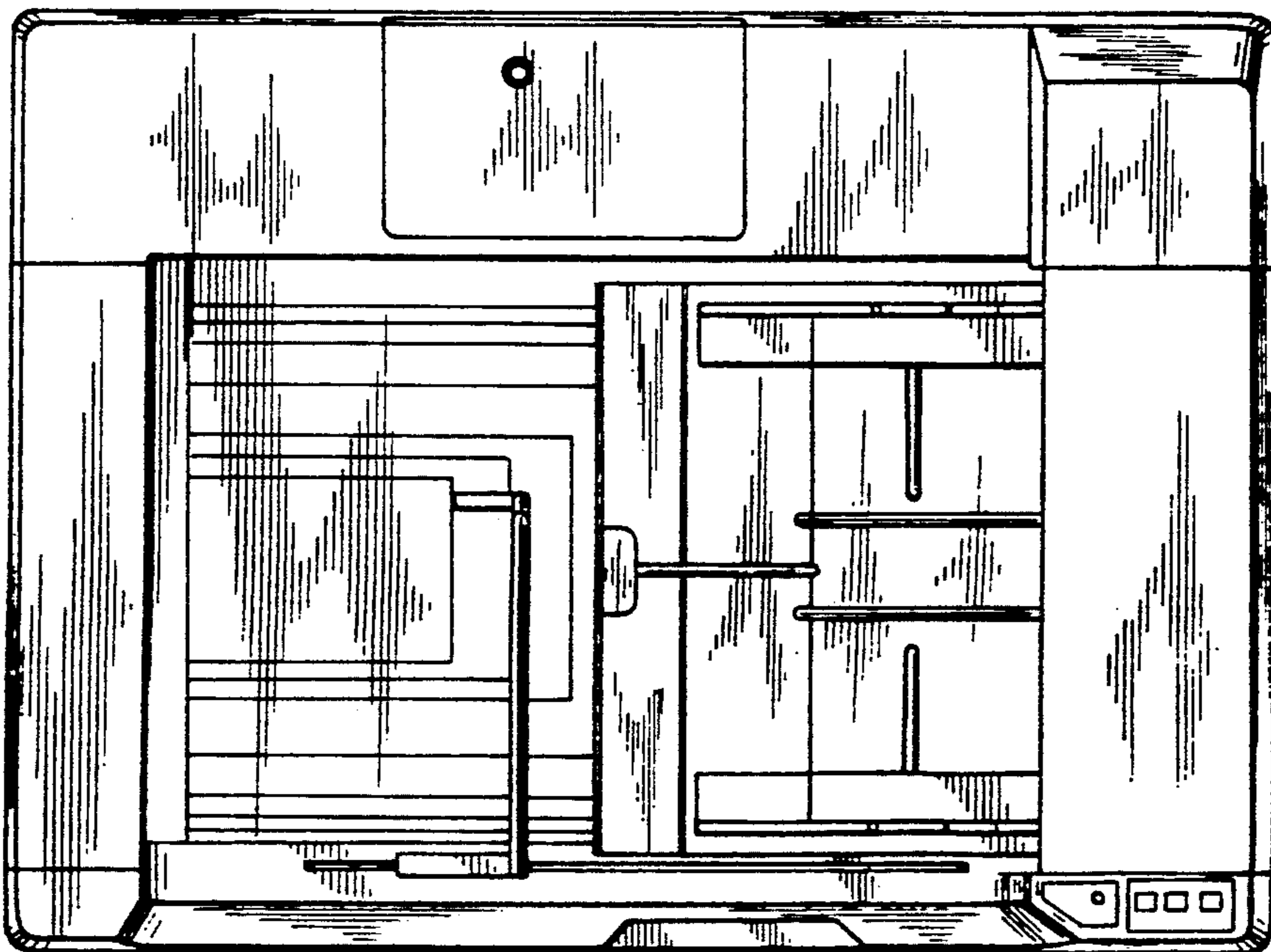

FIG. 10

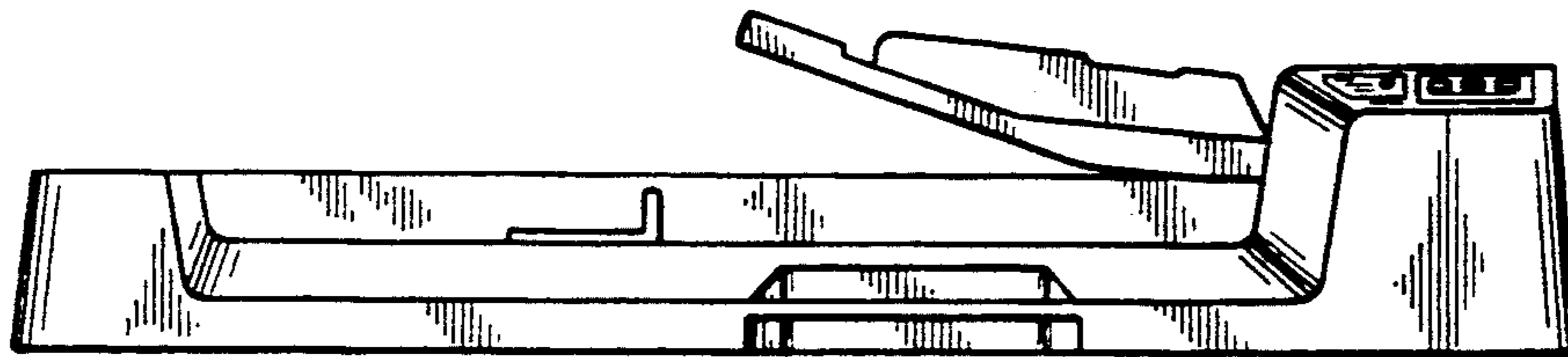

FIG. 11

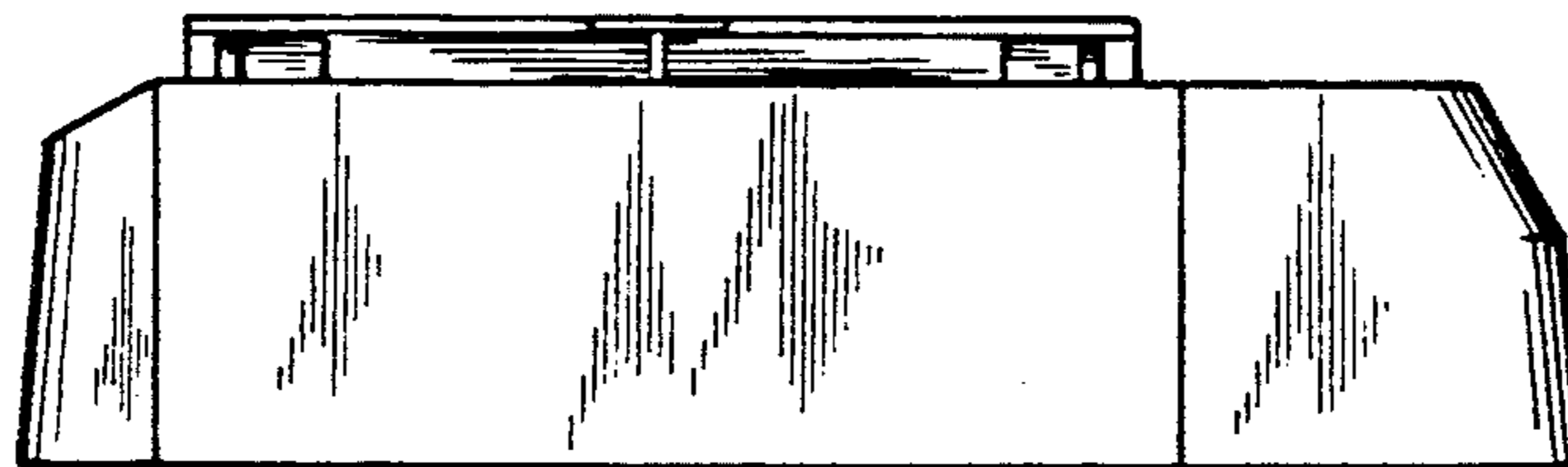

FIG. 12



FIG. 13

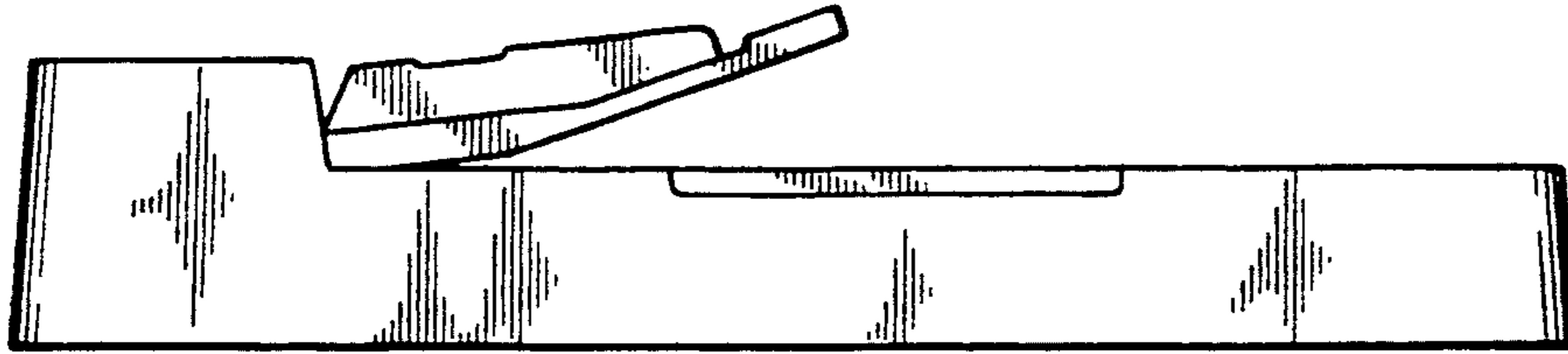

FIG. 14

