



US00D329374S

United States Patent [19]

[11] Patent Number: **Des. 329,374**

Kaga

[45] Date of Patent: **** Sep. 15, 1992**

[54] CLIP FOR FLAT CABLE

[75] Inventor: **Hiromitsu Kaga**, Tsukui, Japan

[73] Assignee: **Nikko Kogyo Kabushiki Kaisha**, Kanagawa, Japan

[**] Term: **14 Years**

[21] Appl. No.: **580,627**

[22] Filed: **Sep. 11, 1990**

[52] U.S. Cl. **D8/394; D8/356**

[58] Field of Search **D8/356, 395, 396; 24/16 PB; 248/74.2, 73, 74.3**

[56] References Cited

U.S. PATENT DOCUMENTS

| | | | |
|------------|---------|----------------------|----------|
| D. 291,177 | 8/1987 | Santucci et al. | D8/382 X |
| D. 299,008 | 12/1988 | Häslund | D8/395 X |
| D. 308,017 | 5/1990 | Fujioka | D8/396 |
| D. 310,020 | 8/1990 | Fujioka | D8/382 X |
| 3,289,260 | 12/1966 | Buscall, Jr. | D8/356 X |
| 4,457,482 | 7/1984 | Khagawa | 248/73 X |

OTHER PUBLICATIONS

Dek, Inc., Dec. 8, 1977, p. 11, flat wire dip, at top of page.

Primary Examiner—Susan J. Lucas
Assistant Examiner—H. Baynham
Attorney, Agent, or Firm—Martin Smolowitz

[57] CLAIM

The ornamental design for a clip for flat cable, as shown and described.

DESCRIPTION

FIG. 1 is a side elevational view of a clip for flat cable showing my new design;
FIG. 2 is a rear elevational view thereof;
FIG. 3 is an opposite side elevational view thereof;
FIG. 4 is a top plan view thereof;
FIG. 5 is a front elevational view thereof;
FIG. 6 is a bottom plan view thereof;
FIG. 7 is a side elevational view thereof in a closed position; and,
FIG. 8 is a top side perspective view of the clip in an open position.
The broken line showing of a flat wire in FIG. 7 is for illustrative purposes only and forms no part of the claimed design.

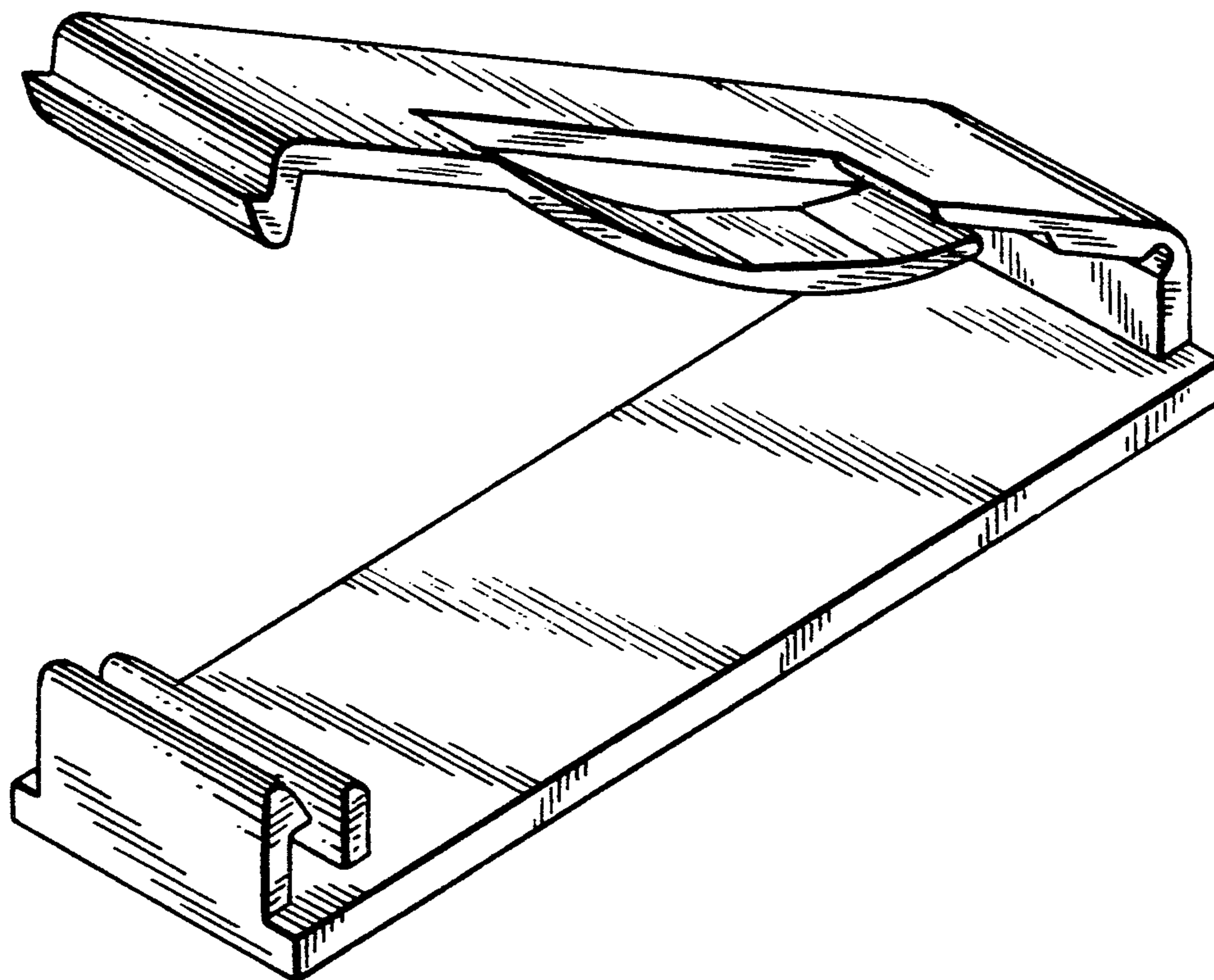

FIG. 1

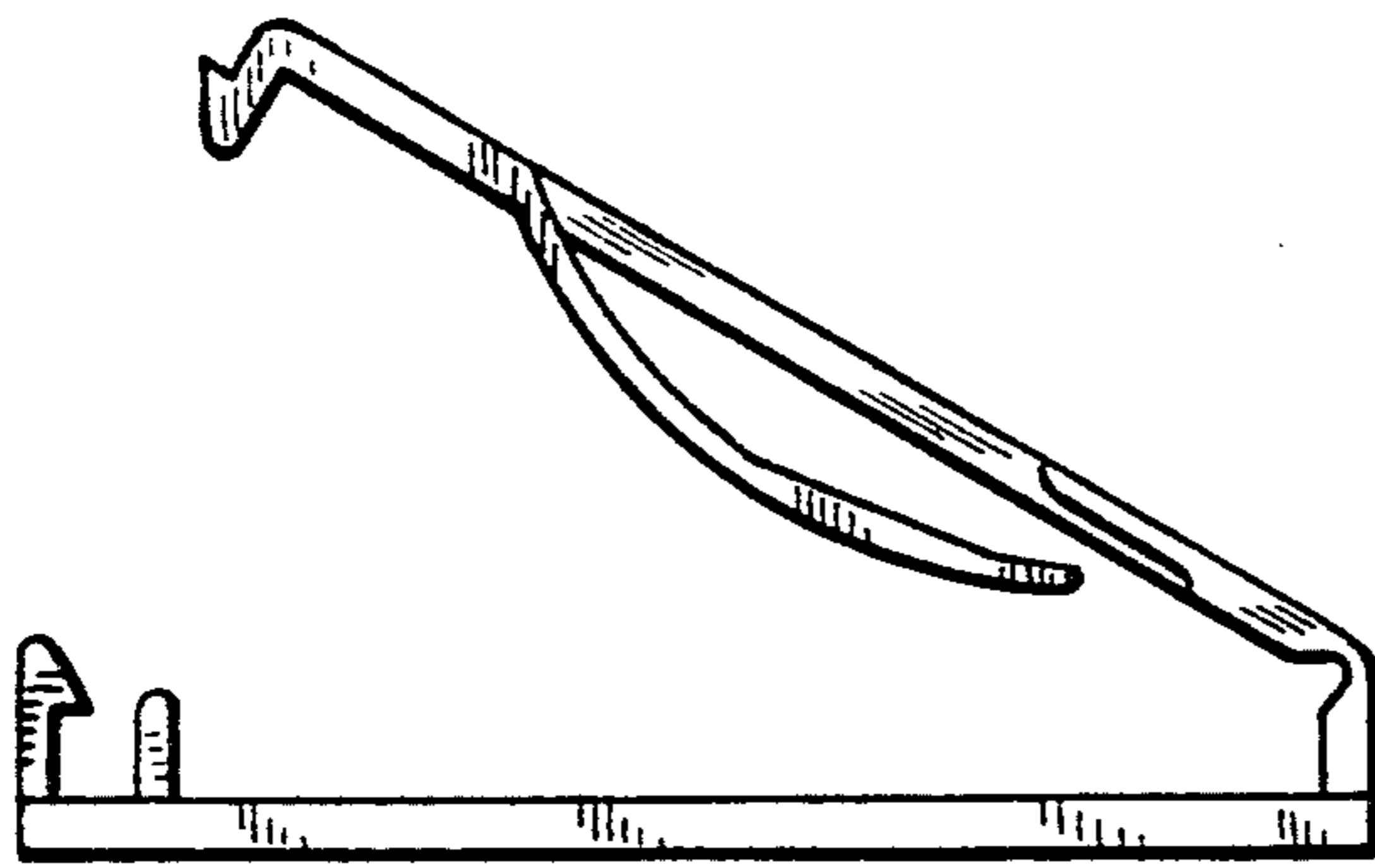

FIG. 2

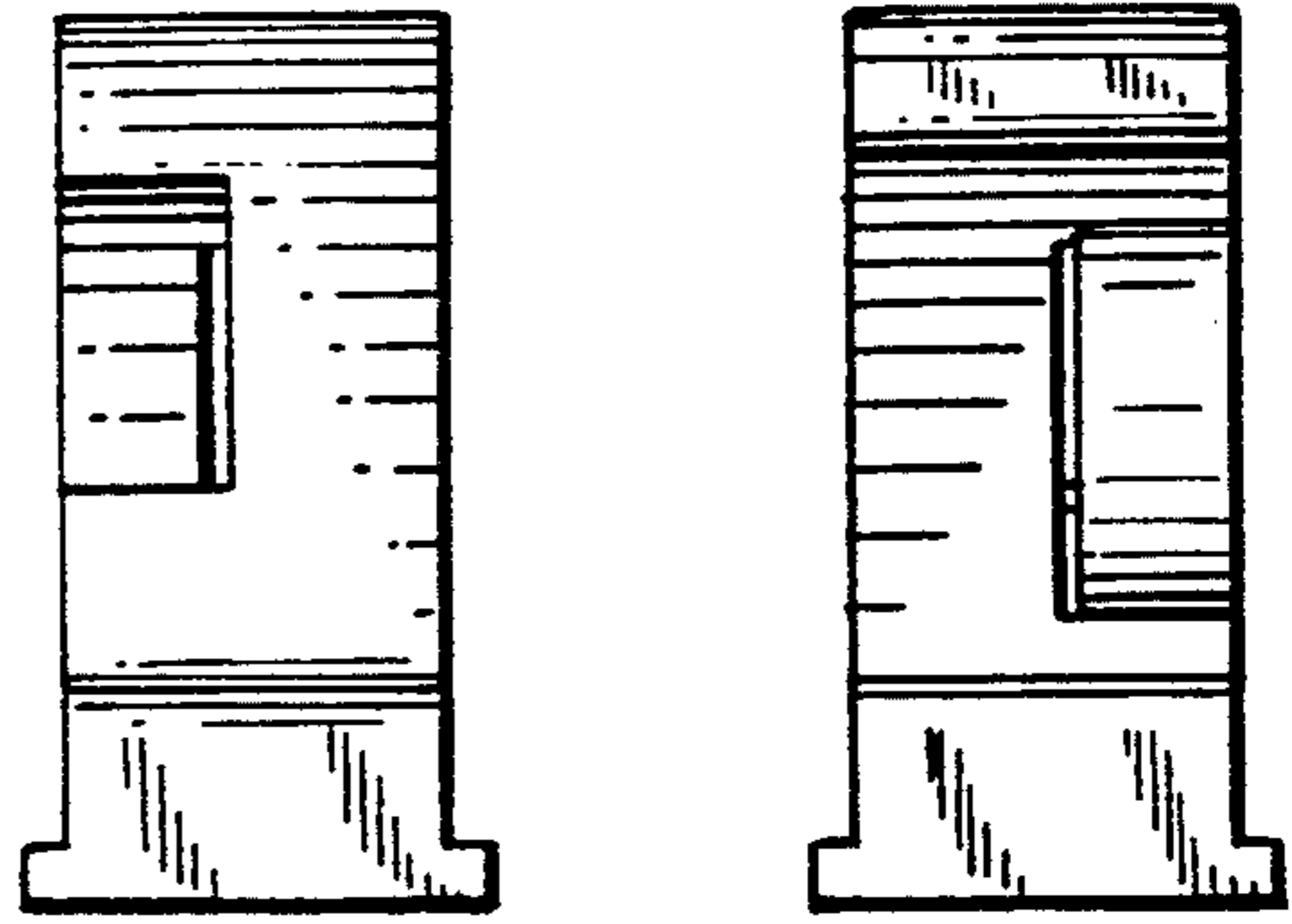

FIG. 4

FIG. 3



FIG. 5

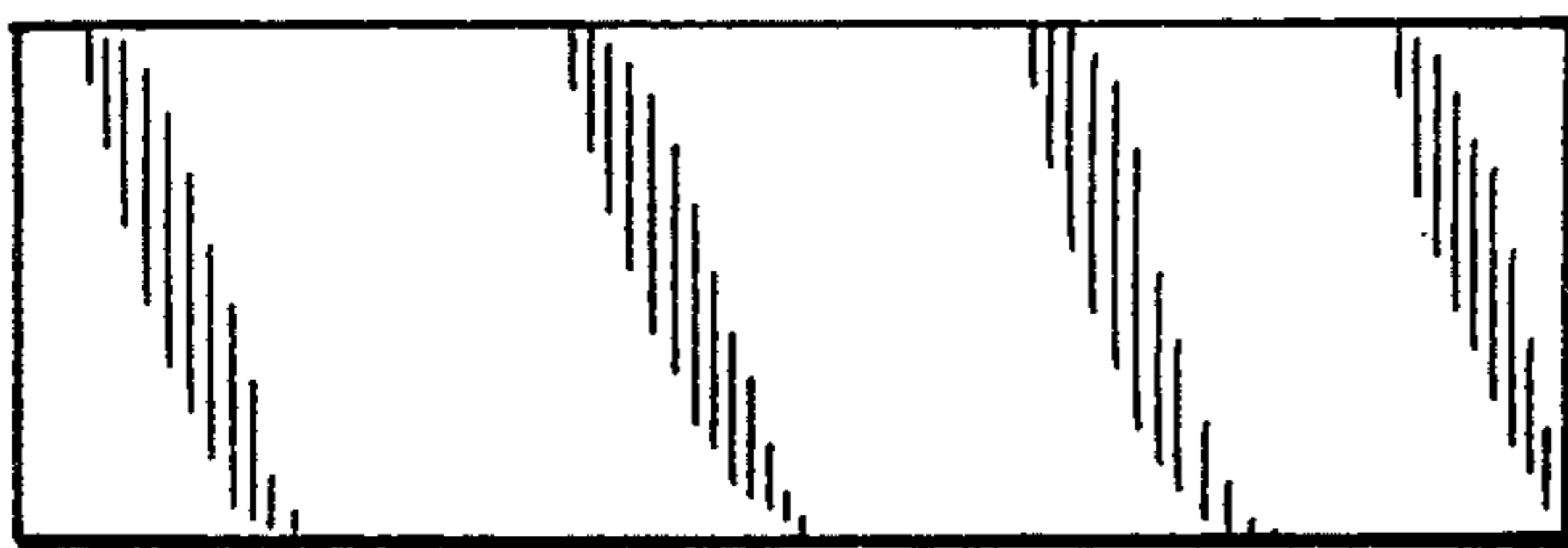
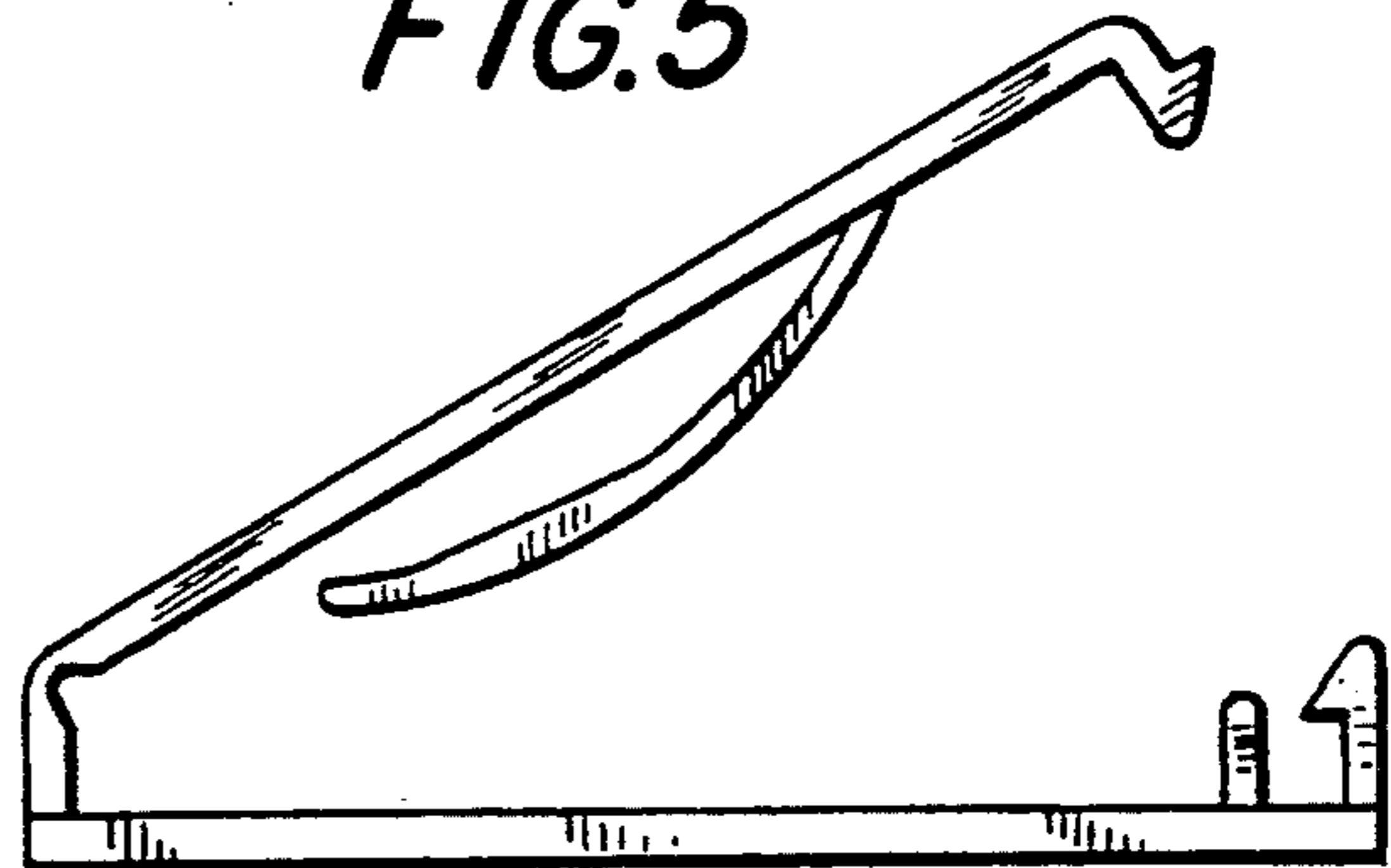
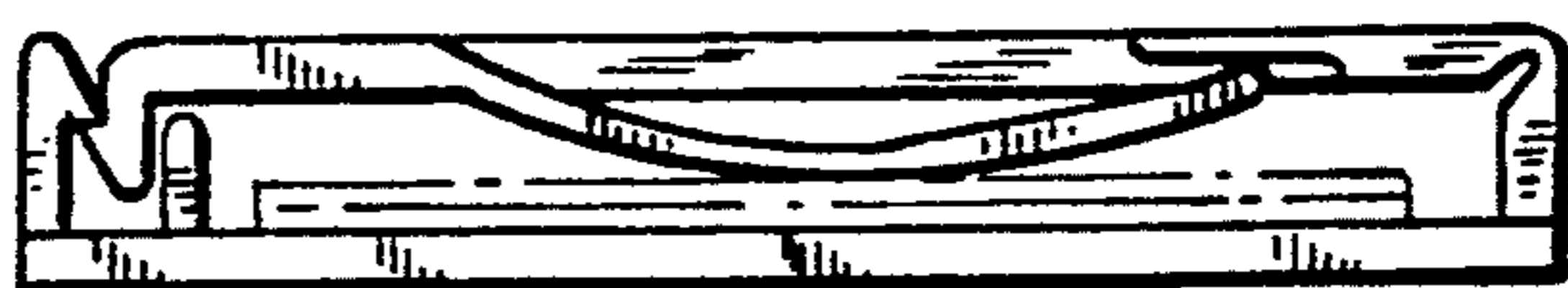

FIG. 6

FIG. 7



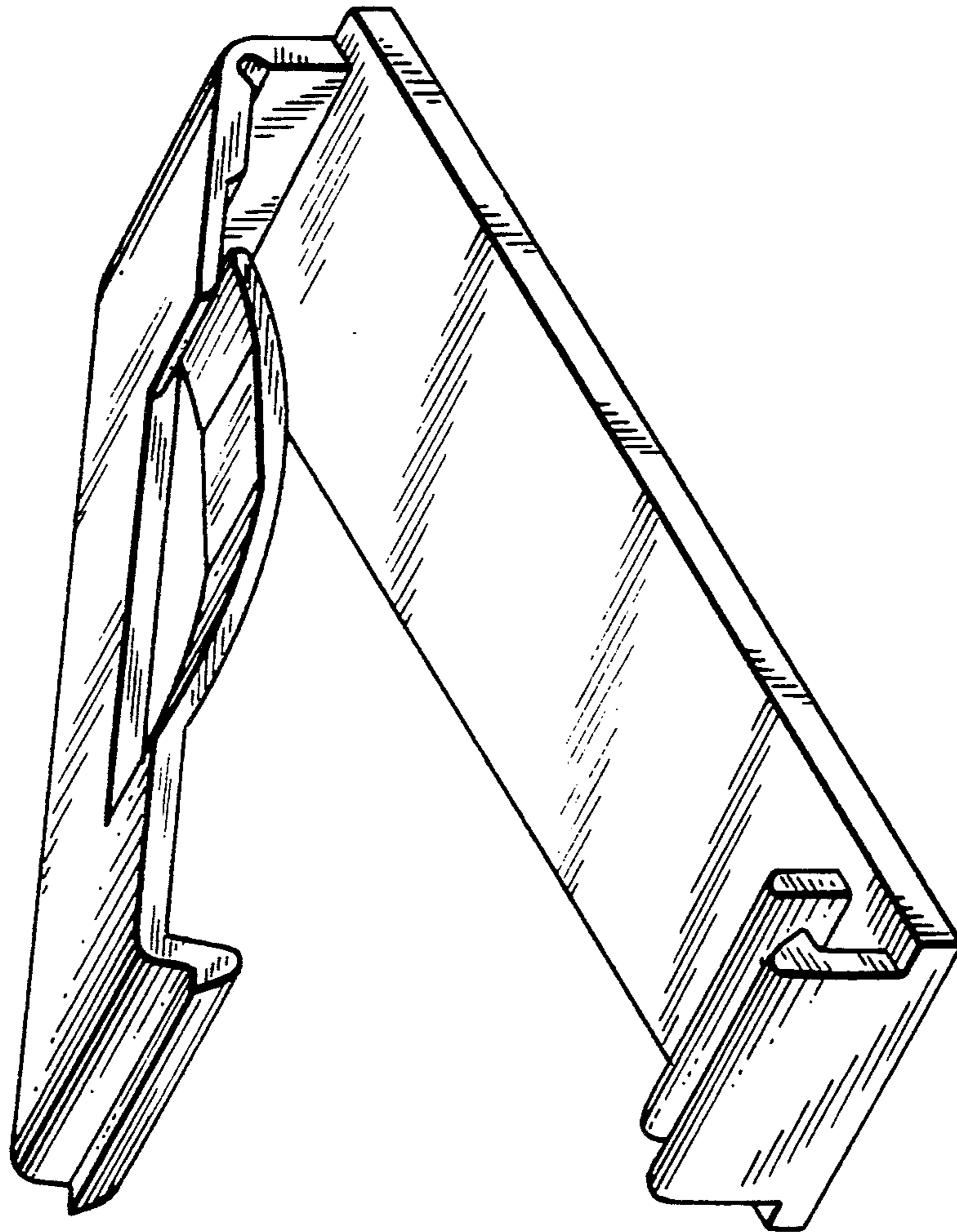

FIG. 8