



US00D329354S

United States Patent [19]

[11] Patent Number: **Des. 329,354**

Mejia et al.

[45] Date of Patent: **** Sep. 15, 1992**

[54] **COFFEE DISPENSER FOR ESPRESSO MACHINE**

4,676,396	6/1987	Mamolou	D7/400 X
4,832,845	6/1989	Hendretti	99/306 X
4,859,337	8/1989	Woltermann	D7/400 X
5,004,118	4/1991	England et al.	220/216
5,064,533	11/1991	Anson	99/295 X

[76] Inventors: **Martin Mejia; Fausto Del Monte**, both of 323 68th St., Guttenberg, N.J. 07093

Primary Examiner—Donald P. Walsh
Assistant Examiner—M. N. Pandozzi
Attorney, Agent, or Firm—Charles I. Brodsky

[**] Term: **14 Years**

[21] Appl. No.: **586,707**

[57] **CLAIM**

[22] Filed: **Sep. 21, 1990**

The ornamental design for a coffee dispenser for espresso machine, as shown and described.

[52] U.S. Cl. **D7/399; D7/400**

[58] Field of Search **D7/399, 400, 397, 305, D7/314, 320; 220/263, 264; 99/295, 289, 407, 289, 289 R, 289 D, 323; 210/474, 477, 482; 222/368**

DESCRIPTION

[56] **References Cited**

U.S. PATENT DOCUMENTS

D. 289,726	5/1987	Greutert	D7/400
123,258	1/1872	Goodrich	99/300 X
2,187,029	1/1940	Hevers	99/295 X
4,602,557	7/1986	Yip	99/279
4,642,190	2/1987	Zimmerman	210/477 X

FIG. 1 is a top, front, right, perspective view of a coffee dispenser for espresso machine, showing our new design;
FIG. 2 is a top plan view thereof;
FIG. 3 is a bottom plan view thereof;
FIG. 4 is a bottom plan view thereof;
FIG. 5 is a front elevational view thereof;
FIG. 6 is a rear elevational view thereof;
FIG. 7 is a left side elevational view thereof; and,
FIG. 8 is a right side elevational view thereof.

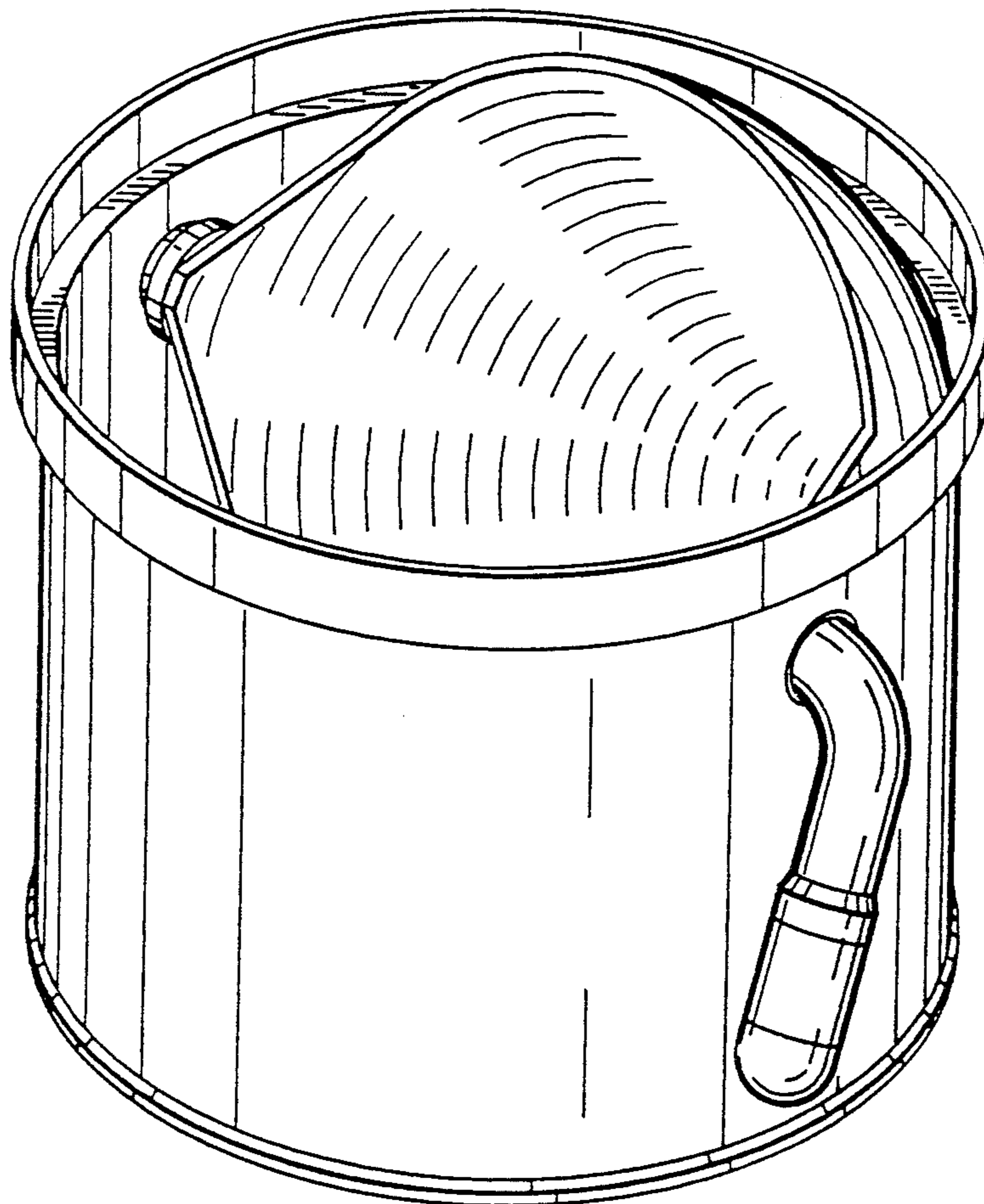

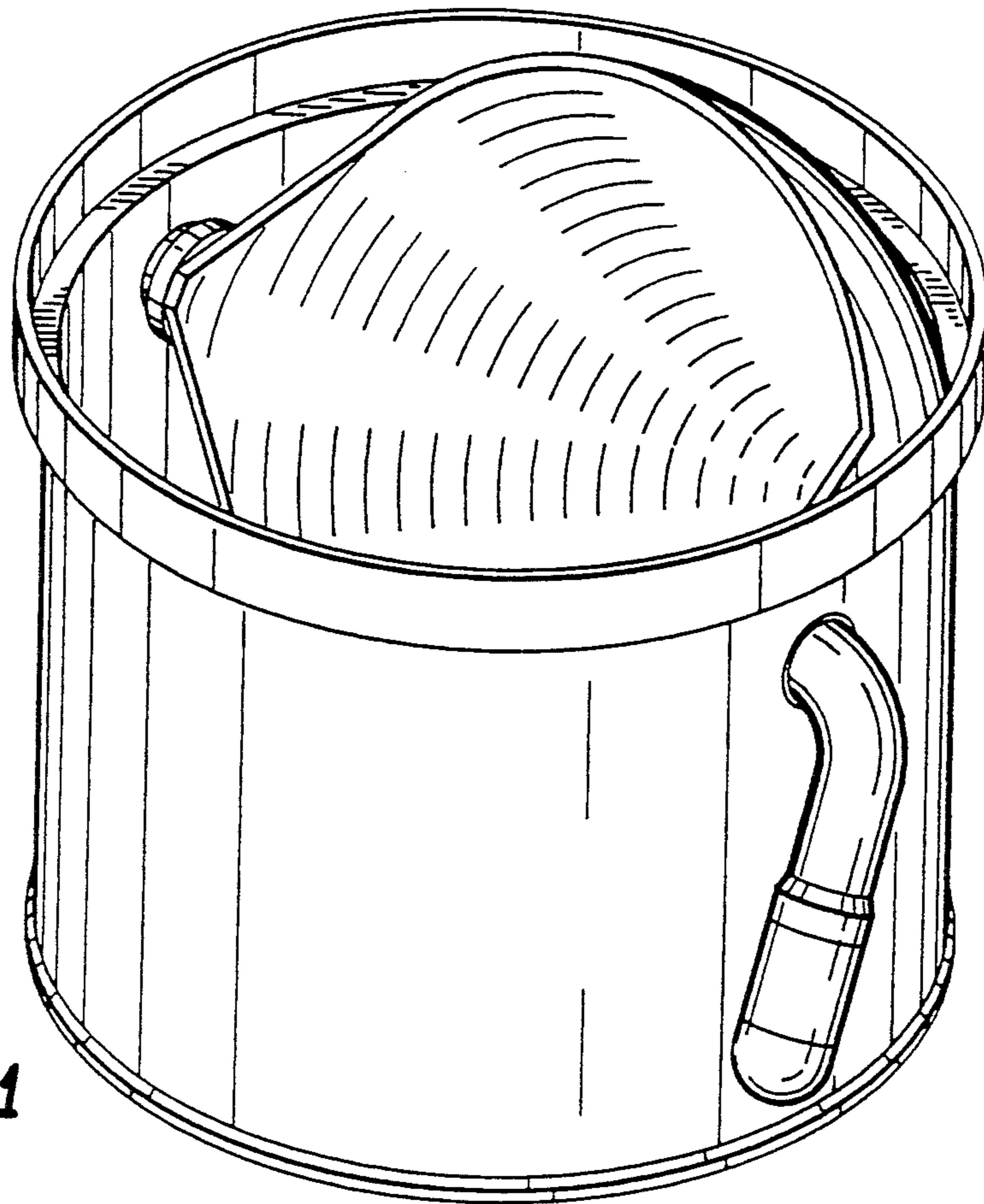

FIG. 1

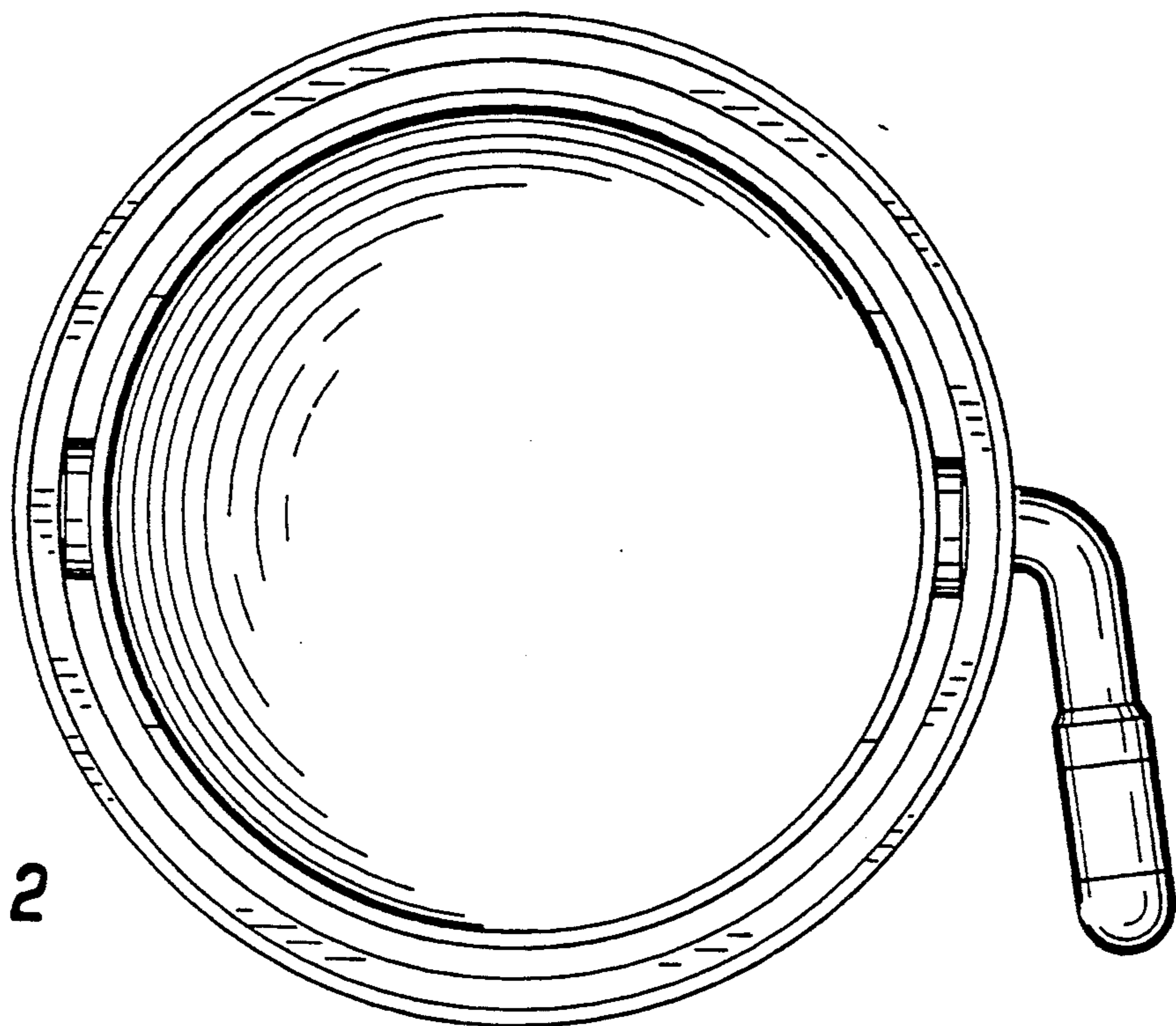

FIG. 2

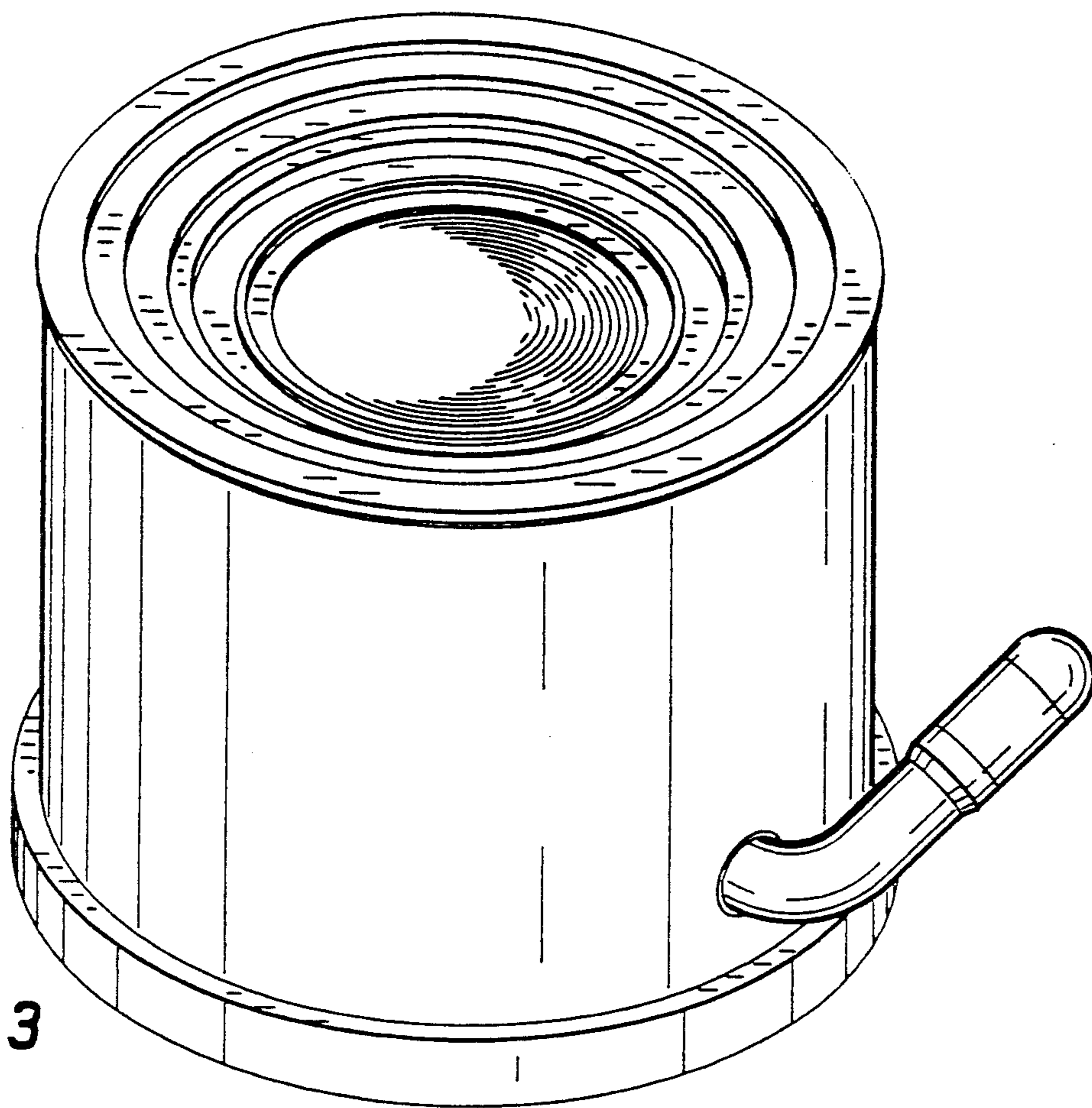

FIG. 3

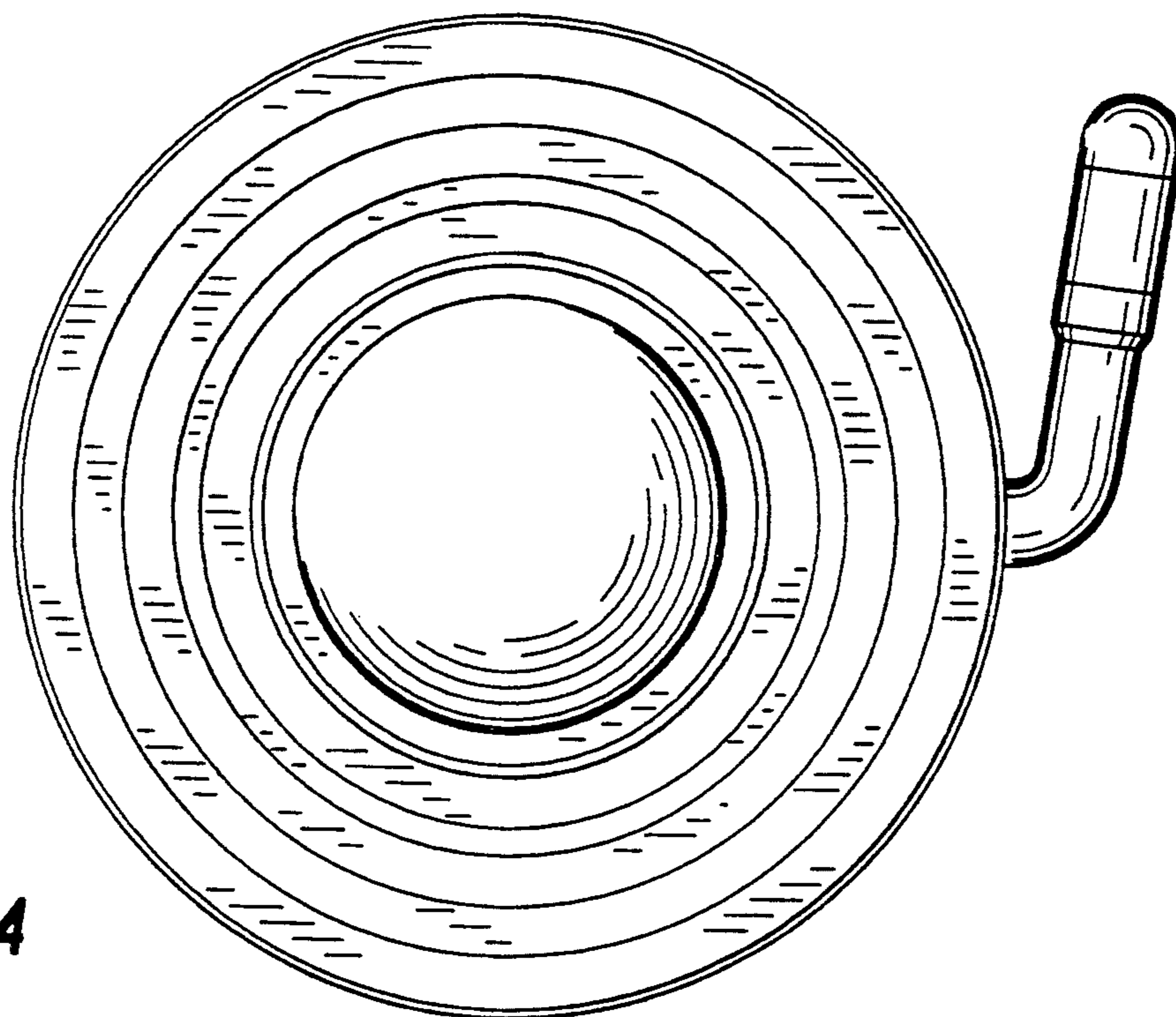

FIG. 4

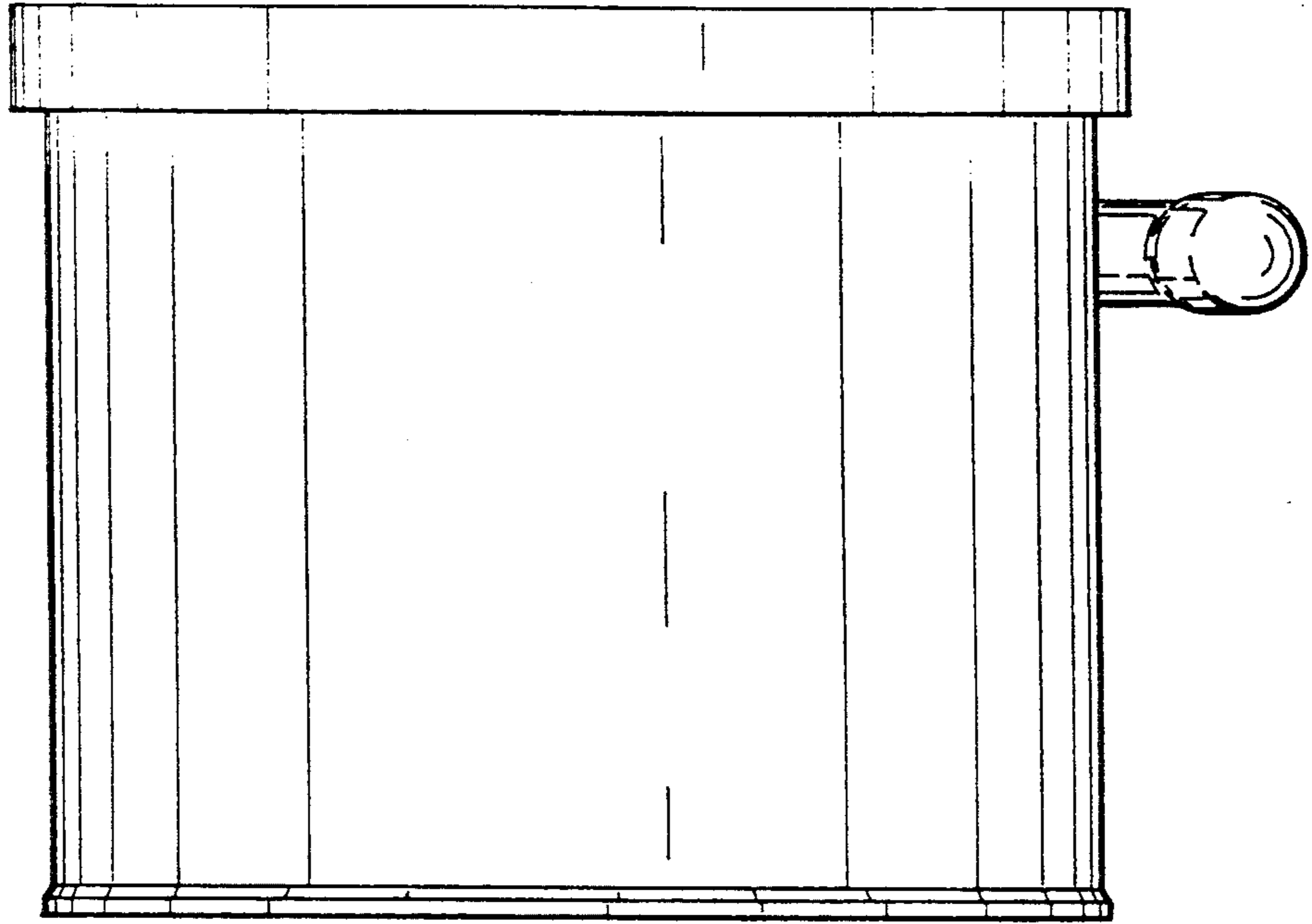

FIG. 5

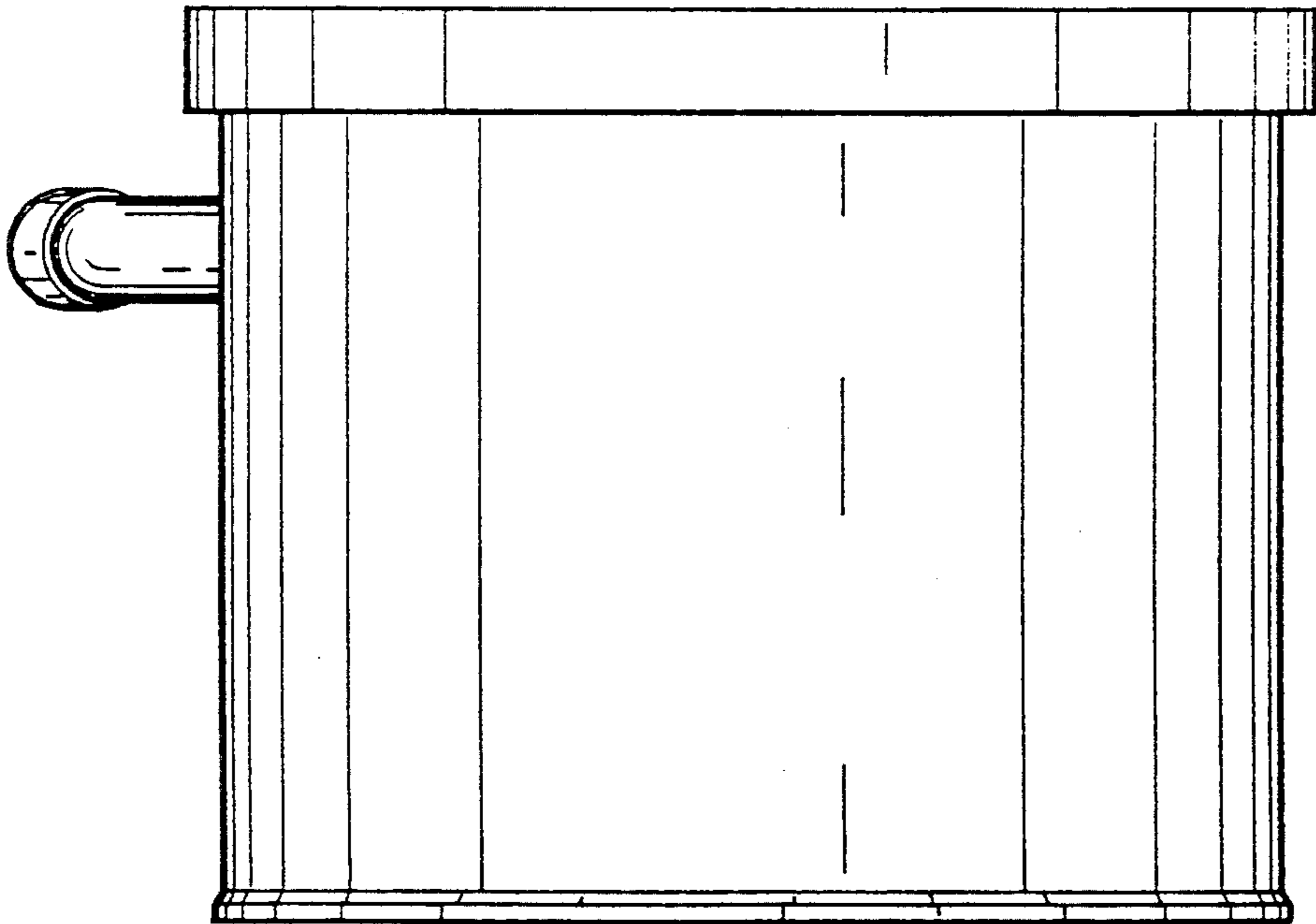

FIG. 6

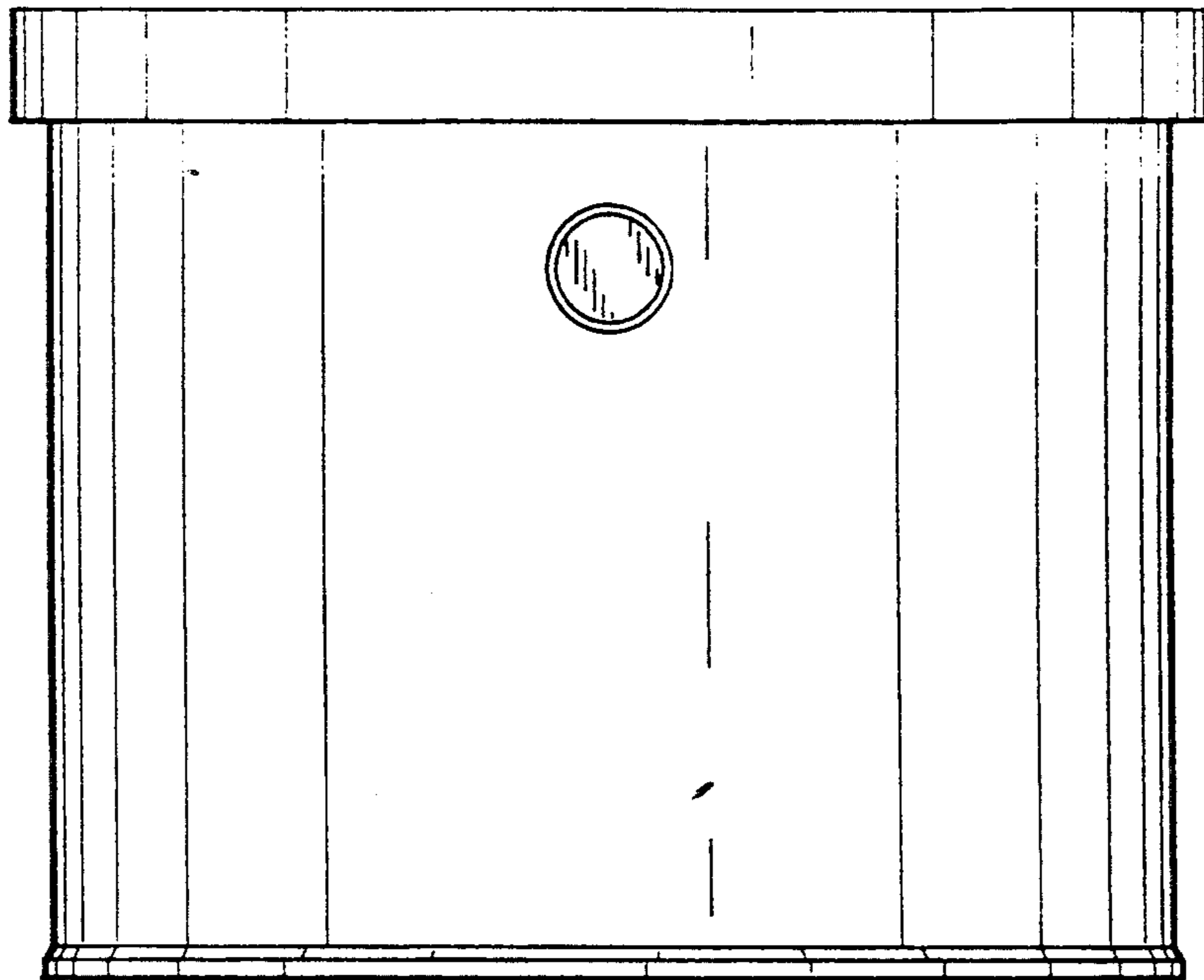

FIG. 7

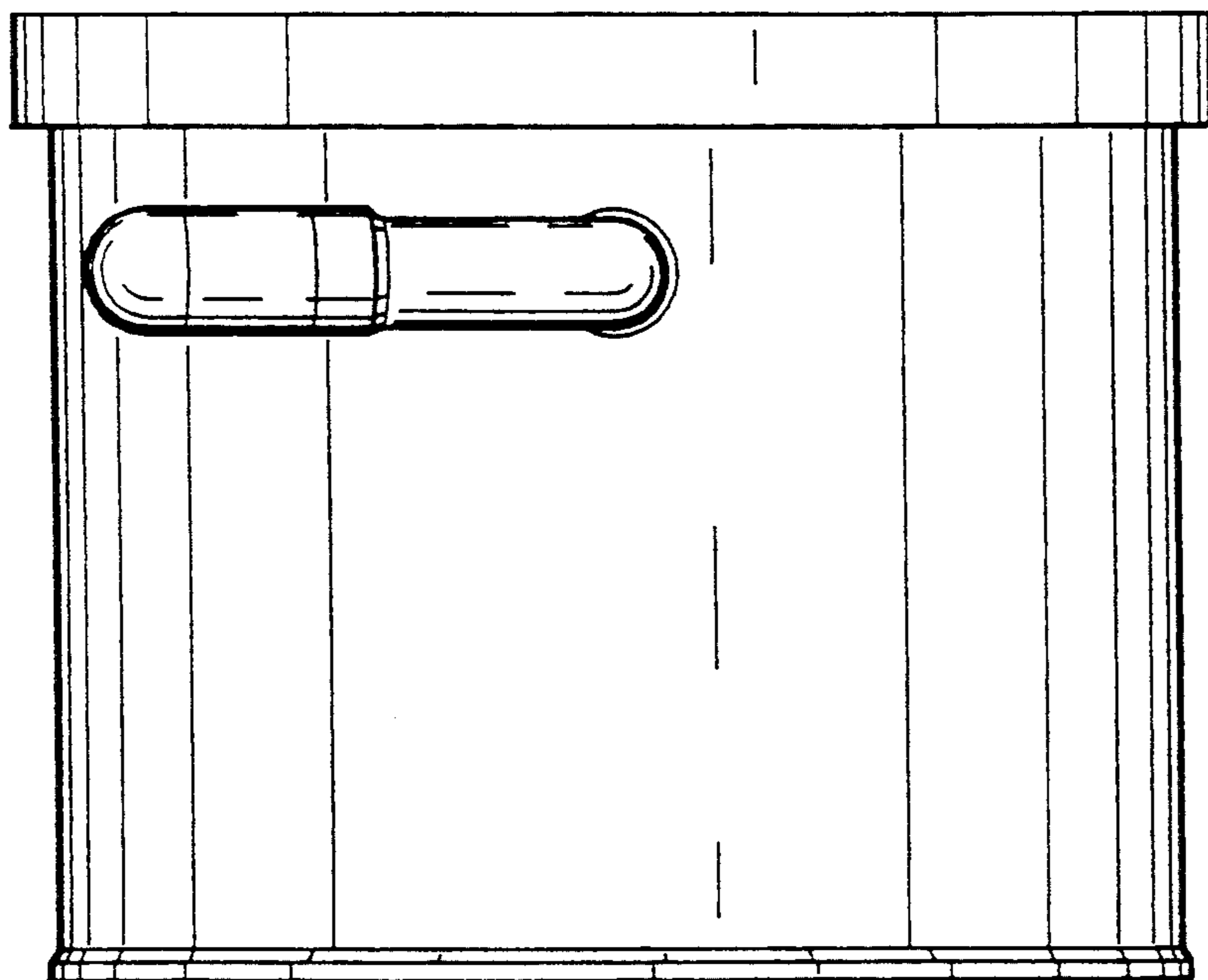

FIG. 8