



US00D329333S

United States Patent [19]

[11] Patent Number: **Des. 329,333**

Ackeret

[45] Date of Patent: **** Sep. 15, 1992**

[54] **COMBINED FRAME AND CONTAINER FOR PICTURES**

- [75] Inventor: **Peter Ackeret, Kusunacht, Switzerland**
- [73] Assignee: **Licinvest AG, Chur, Switzerland**
- [**] Term: **14 Years**
- [21] Appl. No.: **318,194**
- [22] Filed: **Mar. 2, 1989**

Related U.S. Application Data

- [63] Continuation-in-part of Ser. No. 933,179, Nov. 21, 1986, abandoned, and a continuation-in-part of Ser. No. 17,797, Feb. 24, 1987, Pat. No. D. 309,679, and a continuation-in-part of Ser. No. 36,841, Apr. 9, 1987, Pat. No. D. 304,884, and a continuation-in-part of Ser. No. 276,435, Nov. 23, 1988, abandoned.

[30] **Foreign Application Priority Data**

- May 26, 1988 [WO] World Int. Prop. O. DM/011027
- [52] U.S. Cl. **D6/300**
- [58] Field of Search **D6/300-314;**
40/152, 152.1, 490, 511, 513, 642

[56] **References Cited**

U.S. PATENT DOCUMENTS

D. 270,061	8/1983	Ackeret	D16/11
D. 270,062	8/1983	Ackeret	D16/11
D. 270,063	8/1983	Ackeret	D16/11
D. 270,064	8/1983	Ackeret	D16/11
D. 270,065	8/1983	Ackeret	D16/11
D. 270,066	8/1983	Ackeret	D16/11
D. 270,067	8/1983	Ackeret	D16/11
D. 270,068	8/1983	Ackeret	D16/11
D. 277,388	1/1985	Ackeret	D16/11
1,940,328	12/1933	Schrotenboer	229/8
4,238,899	12/1980	Ackeret	40/513
4,241,528	12/1980	Ackeret	40/513
4,241,529	12/1980	Baur	40/513
4,259,802	4/1981	Ackeret	40/513
4,376,348	3/1983	Ackeret	40/513
4,415,079	11/1983	Ackeret	206/45.34
4,458,434	7/1984	Ackeret	40/513
4,550,516	11/1985	Ackeret	40/513
4,571,865	2/1986	Ackeret	40/10 R
4,780,976	11/1988	Ackeret	40/511

FOREIGN PATENT DOCUMENTS

- 2833410 2/1980 Fed. Rep. of Germany .
- 3014394 10/1981 Fed. Rep. of Germany .
- 3110129 11/1981 Fed. Rep. of Germany .
- 3236643 4/1984 Fed. Rep. of Germany .
- 305914 2/1929 United Kingdom .

Primary Examiner—Terry A. Pfeffer
Attorney, Agent, or Firm—Robert R. Jackson

[57] **CLAIM**

The ornamental designs for combined frame and container for pictures, as shown and described.

DESCRIPTION

FIG. 1 is a front elevational view of combined frame and container for pictures showing my new design;
 FIG. 2 is a left side elevational view thereof;
 FIG. 3 is a top plan view thereof;
 FIG. 4 is a rear elevational view thereof;
 FIG. 5 is a right side elevational view thereof;
 FIG. 6 is a bottom plan view thereof;
 FIG. 7 is a front elevational view of an alternate embodiment of FIG. 1;
 FIG. 8 is a left side elevational view of FIG. 7;
 FIG. 9 is a top plan view of FIG. 7;
 FIG. 10 is a rear elevational view of FIG. 7;
 FIG. 11 is a right side elevational view of FIG. 7;
 FIG. 12 is a bottom plan view of FIG. 7;
 FIG. 13 is a front elevational view of an alternate embodiment of FIG. 1;
 FIG. 14 is a left side elevational view of FIG. 13;
 FIG. 15 is a top plan view of FIG. 13;
 FIG. 16 is a rear elevational view of FIG. 13;
 FIG. 17 is a right side elevational view of FIG. 13;
 FIG. 18 is a bottom plan view of FIG. 13;
 FIG. 19 is a front elevational view of an alternate embodiment of FIG. 1;
 FIG. 20 is a left side elevational view of FIG. 19;
 FIG. 21 is a top plan view of FIG. 19;
 FIG. 22 is a rear elevational view of FIG. 19;
 FIG. 23 is a right side elevational view of FIG. 19;
 FIG. 24 is a bottom plan view of FIG. 19;
 FIG. 25 is a front elevational view of an alternate embodiment of FIG. 1;
 FIG. 26 is a left side elevational view of FIG. 25;

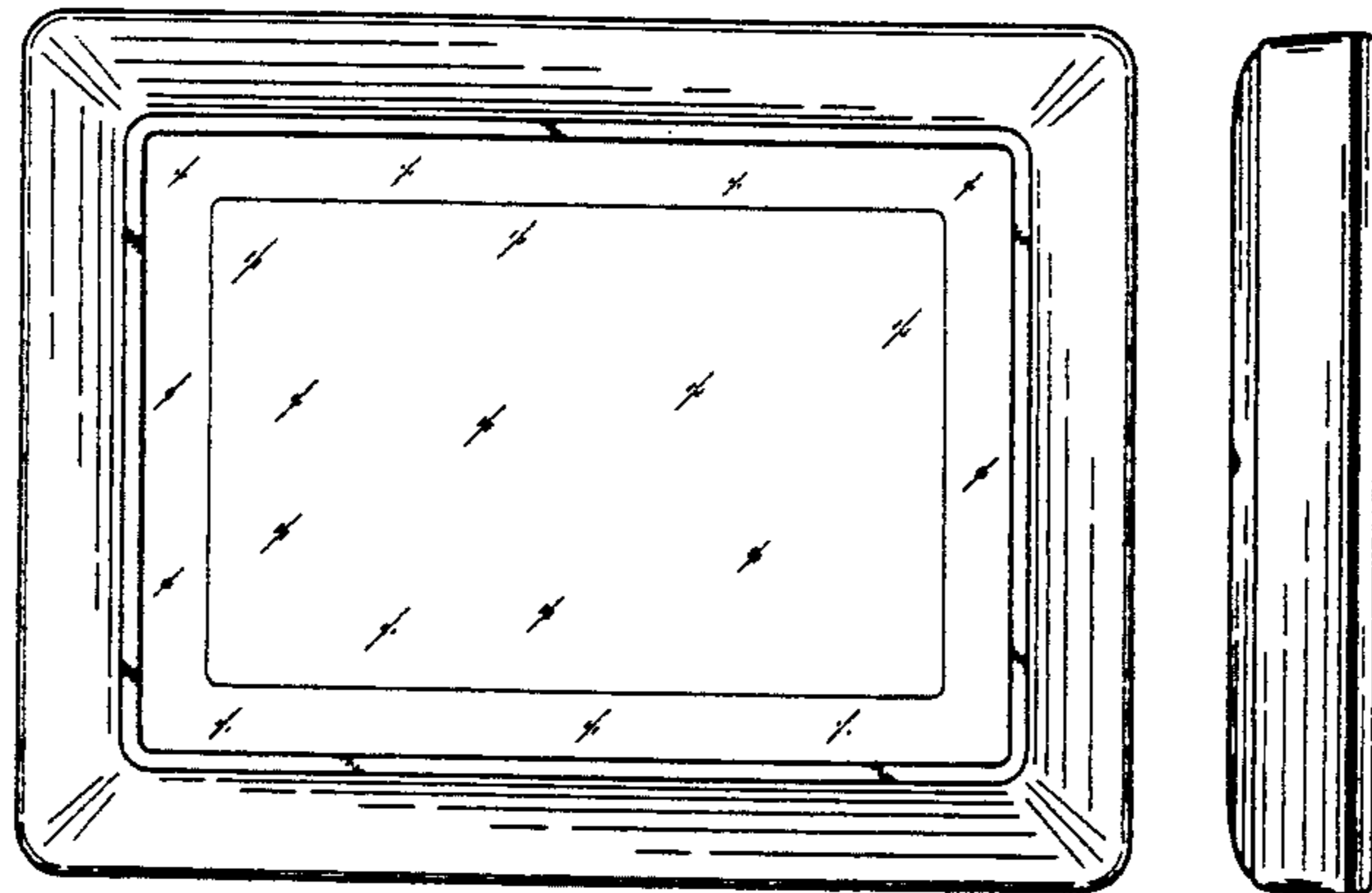

FIG. 27 is a top plan view of FIG. 25;
FIG. 28 is a rear elevational view of FIG. 25;
FIG. 29 is a right side elevational view of FIG. 25;
FIG. 30 is a bottom plan view of FIG. 25;
FIG. 31 is a front elevational view of an alternate embodiment of FIG. 1;
FIG. 32 is a left side elevational view of FIG. 31;
FIG. 33 is a top plan view of FIG. 31;
FIG. 34 is a rear elevational view of FIG. 31;
FIG. 35 is a right side elevational view of FIG. 31;
FIG. 36 is a bottom plan view of FIG. 31;
FIG. 37 is a front elevational view of an alternate embodiment of FIG. 1;
FIG. 38 is a left side elevational view of FIG. 37;
FIG. 39 is a top plan view of FIG. 37;
FIG. 40 is a rear elevational view of FIG. 37;
FIG. 41 is a right side elevational view of FIG. 37;
FIG. 42 is a bottom plan view of FIG. 37;
FIG. 43 is a front elevational view of an alternate embodiment of FIG. 1;
FIG. 44 is a left side elevational view of FIG. 43;
FIG. 45 is a top plan view of FIG. 43;
FIG. 46 is a rear elevational view of FIG. 43;
FIG. 47 is a right side elevational view of FIG. 43;
FIG. 48 is a bottom plan view of FIG. 43;
FIG. 49 is a front elevational view of an alternate embodiment of FIG. 1;
FIG. 50 is a left side elevational view of FIG. 49;
FIG. 51 is a top plan view of FIG. 49;
FIG. 52 is a rear elevational view of FIG. 49;
FIG. 53 is a right side elevational view of FIG. 49;
FIG. 54 is a bottom plan view of FIG. 49;
FIG. 55 is a front elevational view of an alternate embodiment of FIG. 1;
FIG. 56 is a left side elevational view of FIG. 55;
FIG. 57 is a top plan view of FIG. 55;
FIG. 58 is a rear elevational view of FIG. 55;
FIG. 59 is a right side elevational view of FIG. 55;
FIG. 60 is a bottom plan view of FIG. 55;
FIG. 61 is a front elevational view of an alternate embodiment of FIG. 1;
FIG. 62 is a left side elevational view of FIG. 61;
FIG. 63 is a top plan view of FIG. 61;
FIG. 64 is a rear elevational view of FIG. 61;
FIG. 65 is a right side elevational view of FIG. 61;
FIG. 66 is a bottom plan view of FIG. 61;

FIG. 67 is a front elevational view of an alternate embodiment of FIG. 1;
FIG. 68 is a left side elevational view of FIG. 67;
FIG. 69 is a top plan view of FIG. 67;
FIG. 70 is a rear elevational view of FIG. 67;
FIG. 71 is a right side elevational view of FIG. 67;
FIG. 72 is a bottom plan view of FIG. 67;
FIG. 73 is a front elevational view of an alternate embodiment of FIG. 1;
FIG. 74 is a left side elevational view of FIG. 73;
FIG. 75 is a top plan view of FIG. 73;
FIG. 76 is a rear elevational view of FIG. 73;
FIG. 77 is a right side elevational view of FIG. 73;
FIG. 78 is a bottom plan view of FIG. 73;
FIG. 79 is a front elevational view of an alternate embodiment of FIG. 1;
FIG. 80 is a left side elevational view of FIG. 79;
FIG. 81 is a top plan view of FIG. 79;
FIG. 82 is a rear elevational view of FIG. 79;
FIG. 83 is a right side elevational view of FIG. 79;
FIG. 84 is a bottom plan view of FIG. 79;
FIG. 85 is a front elevational view of an alternate embodiment of FIG. 1;
FIG. 86 is a left side elevational view of FIG. 85;
FIG. 87 is a top plan view of FIG. 85;
FIG. 88 is a rear elevational view of FIG. 85;
FIG. 89 is a right side elevational view of FIG. 85;
FIG. 90 is a bottom plan view of FIG. 85;
FIG. 91 is a front elevational view of an alternate embodiment of FIG. 1;
FIG. 92 is a left side elevational view of FIG. 91;
FIG. 93 is a top plan view of FIG. 91;
FIG. 94 is a rear elevational view of FIG. 91;
FIG. 95 is a right side elevational view of FIG. 91;
FIG. 96 is a bottom plan view of FIG. 91;
FIG. 97 is a front elevational view of an alternate embodiment of FIG. 1;
FIG. 98 is a left side elevational view of FIG. 97;
FIG. 99 is a top plan view of FIG. 97;
FIG. 100 is a rear elevational view of FIG. 97;
FIG. 101 is a right side elevational view of FIG. 97;
FIG. 102 is a bottom plan view of FIG. 97;
FIG. 103 is a front elevational view of an alternate embodiment of FIG. 1;
FIG. 104 is a left side elevational view of FIG. 103;
FIG. 105 is a top plan view of FIG. 103;

FIG. 106 is a rear elevational view of FIG. 103;
FIG. 107 is a right side elevational view of FIG. 103;
FIG. 108 is a bottom plan view of FIG. 103;
FIG. 109 is a front elevational view of an alternate embodiment of FIG. 1;
FIG. 110 is a left side elevational view of FIG. 109;
FIG. 111 is a top plan view of FIG. 109;
FIG. 112 is a rear elevational view of FIG. 109;
FIG. 113 is a right side elevational view of FIG. 109;
FIG. 114 is a bottom plan view of FIG. 109;
FIG. 115 is a front elevational view of an alternate embodiment of FIG. 1;
FIG. 116 is a left side elevational view of FIG. 115;
FIG. 117 is a top plan view of FIG. 115;
FIG. 118 is a rear elevational view of FIG. 115;
FIG. 119 is a right side elevational view of FIG. 115;
FIG. 120 is a bottom plan view of FIG. 115;
FIG. 121 is a front elevational view of an alternate embodiment of FIG. 1;
FIG. 122 is a left side elevational view of FIG. 121;
FIG. 123 is a top plan view of FIG. 121;
FIG. 124 is a rear elevational view of FIG. 121;
FIG. 125 is a right side elevational view of FIG. 121;
FIG. 126 is a bottom plan view of FIG. 121;
FIG. 127 is a front elevational view of an alternate embodiment of FIG. 1;
FIG. 128 is a left side elevational view of FIG. 127;
FIG. 129 is a top plan view of FIG. 127;
FIG. 130 is a rear elevational view of FIG. 127;
FIG. 131 is a right side elevational view of FIG. 127;
FIG. 132 is a bottom plan view of FIG. 127;
FIG. 133 is a front elevational view of an alternate embodiment of FIG. 1;
FIG. 134 is a left side elevational view of FIG. 133;
FIG. 135 is a top plan view of FIG. 133;
FIG. 136 is a rear elevational view of FIG. 133;
FIG. 137 is a right side elevational view of FIG. 133;
FIG. 138 is a bottom plan view of FIG. 133;
FIG. 139 is a front elevational view of an alternate embodiment of FIG. 1;
FIG. 140 is a left side elevational view of FIG. 139;
FIG. 141 is a top plan view of FIG. 139;
FIG. 142 is a rear elevational view of FIG. 139;
FIG. 143 is a right side elevational view of FIG. 139;
FIG. 144 is a bottom plan view of FIG. 139;
FIG. 145 is a front elevational view of an alternate embodiment of FIG. 1;
FIG. 146 is a left side elevational view of FIG. 145;
FIG. 147 is a top plan view of FIG. 145;
FIG. 148 is a rear elevational view of FIG. 145;
FIG. 149 is a right side elevational view of FIG. 145;
FIG. 150 is a bottom plan view of FIG. 145;
FIG. 151 is a front elevational view of an alternate embodiment of FIG. 1;
FIG. 152 is a left side elevational view of FIG. 151;
FIG. 153 is a top plan view of FIG. 151;
FIG. 154 is a rear elevational view of FIG. 151;
FIG. 155 is a right side elevational view of FIG. 151;
FIG. 156 is a bottom plan view of FIG. 151;
FIG. 157 is a front elevational view of an alternate embodiment of FIG. 1;
FIG. 158 is a left side elevational view of 157;
FIG. 159 is a top plan view of FIG. 157;
FIG. 160 is a rear elevational view of FIG. 157;
FIG. 161 is a right side elevational view of FIG. 157;
FIG. 162 is a bottom plan view of FIG. 157;
FIG. 163 is a front elevational view of an alternate embodiment of FIG. 1;
FIG. 164 is a left side elevational view of FIG. 163;
FIG. 165 is a top plan view of FIG. 163;
FIG. 166 is a rear elevational view of FIG. 163;
FIG. 167 is a right side elevational view of FIG. 163;
FIG. 168 is a bottom plan view of FIG. 163;
FIG. 169 is a front elevational view of an alternate embodiment of FIG. 1;
FIG. 170 is a left side elevational view of FIG. 169;
FIG. 171 is a top plan view of FIG. 169;
FIG. 172 is a rear elevational view of FIG. 169;
FIG. 173 is a right side elevational view of FIG. 169;
FIG. 174 is a bottom plan view of FIG. 169;
FIG. 175 is a front elevational view of an alternate embodiment of FIG. 1;
FIG. 176 is a left side elevational view of FIG. 175;
FIG. 177 is a top plan view of FIG. 175;
FIG. 178 is a rear elevational view of FIG. 175;
FIG. 179 is a right side elevational view of FIG. 175;
and,
FIG. 180 is a bottom plan view of FIG. 175.

Fig. 1

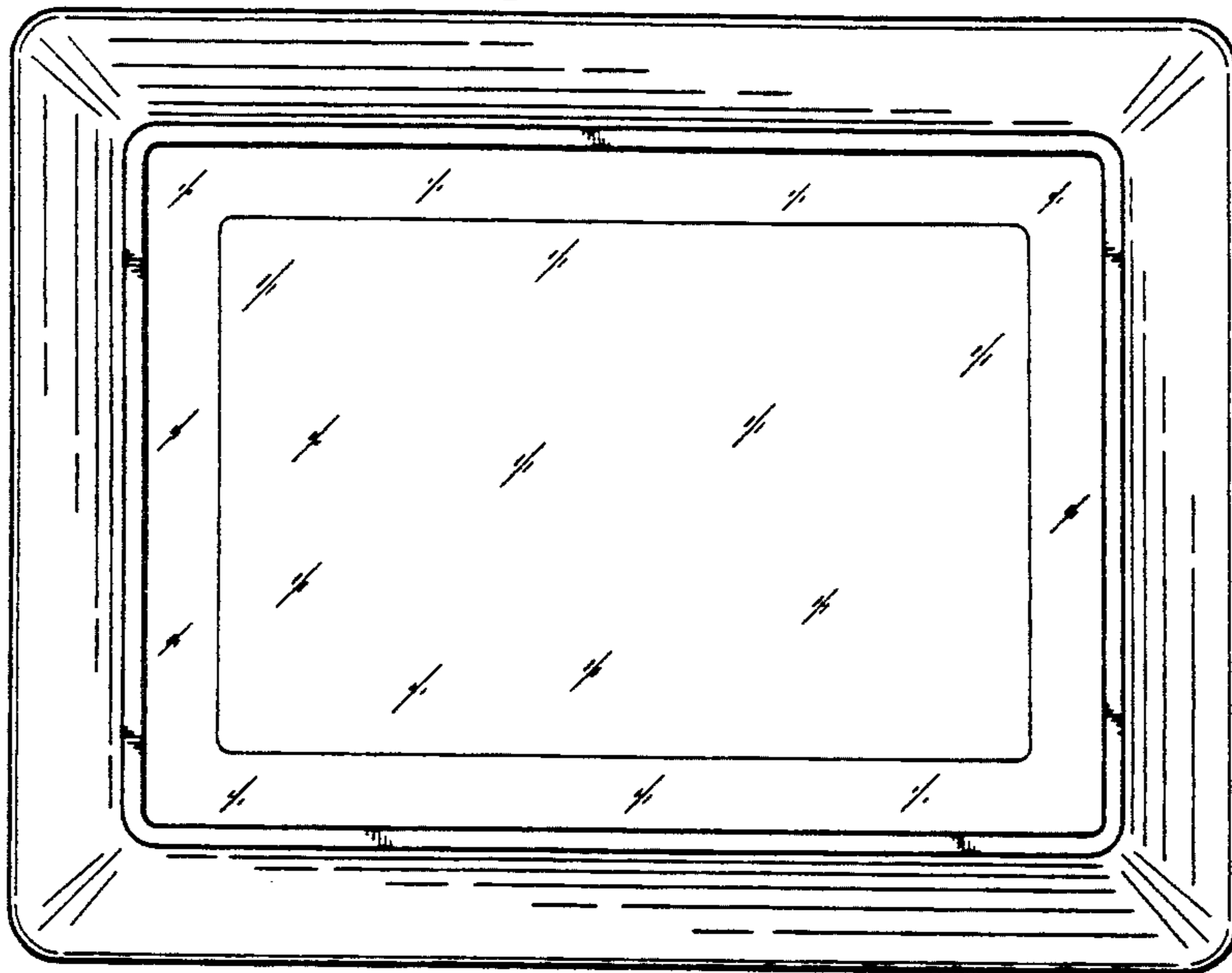

Fig. 2

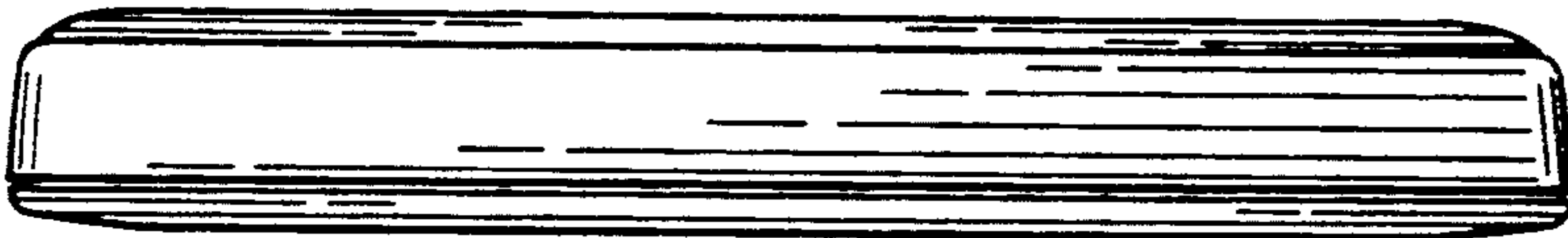

Fig. 3



Fig. 5

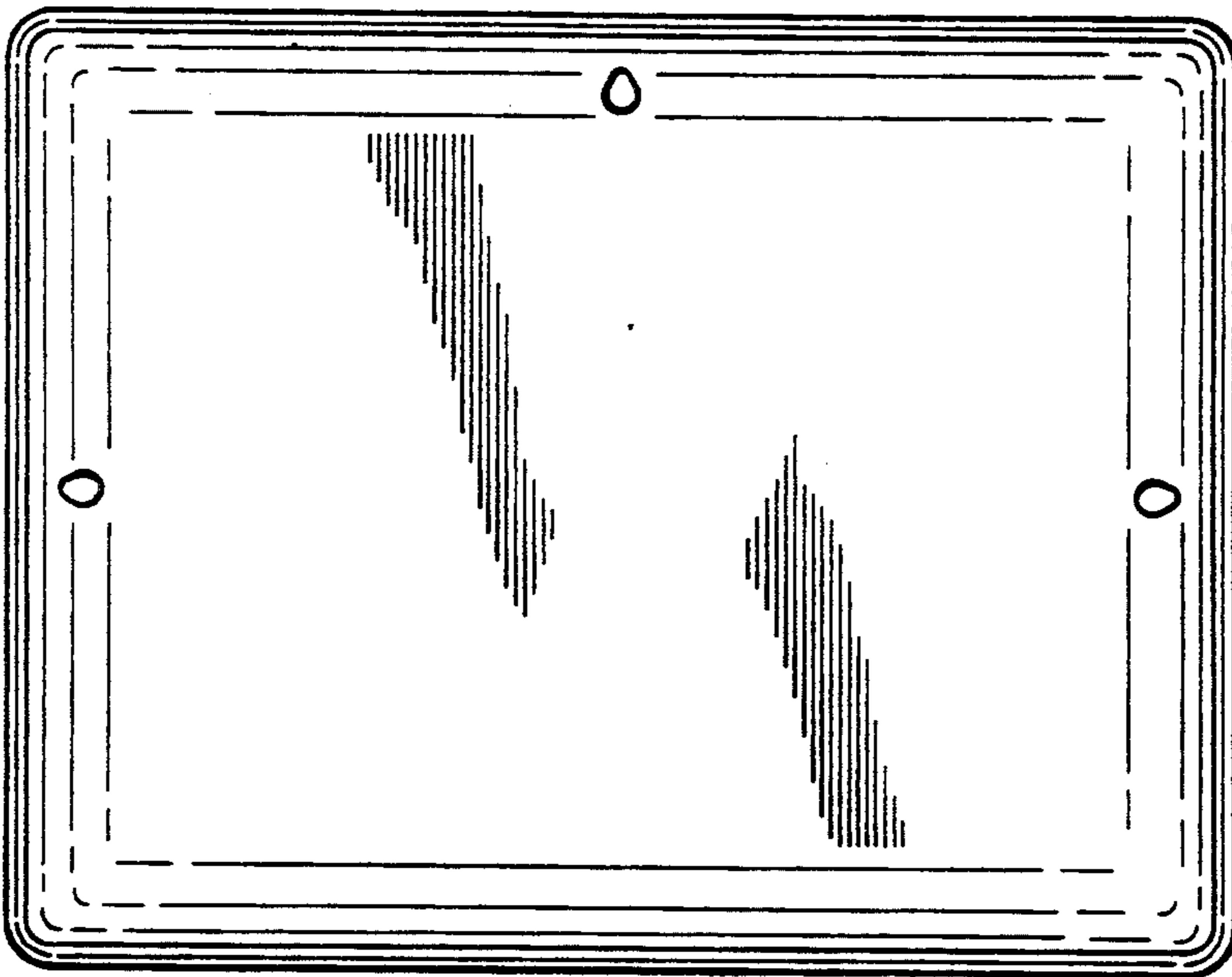

Fig. 4

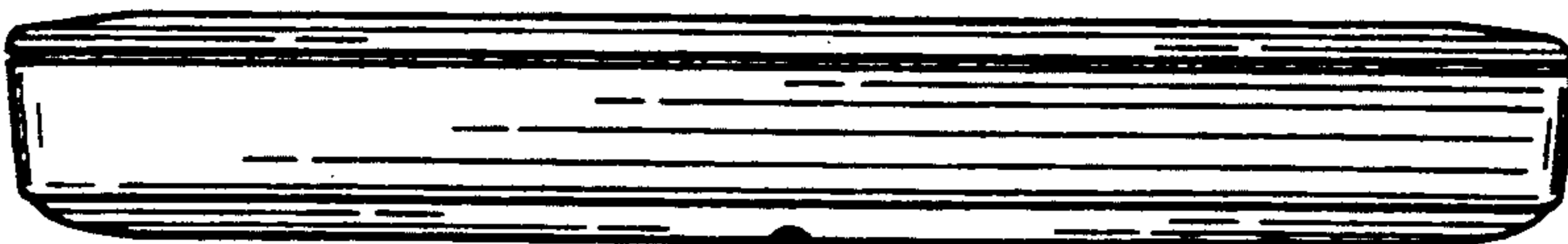

Fig. 6

Fig. 7

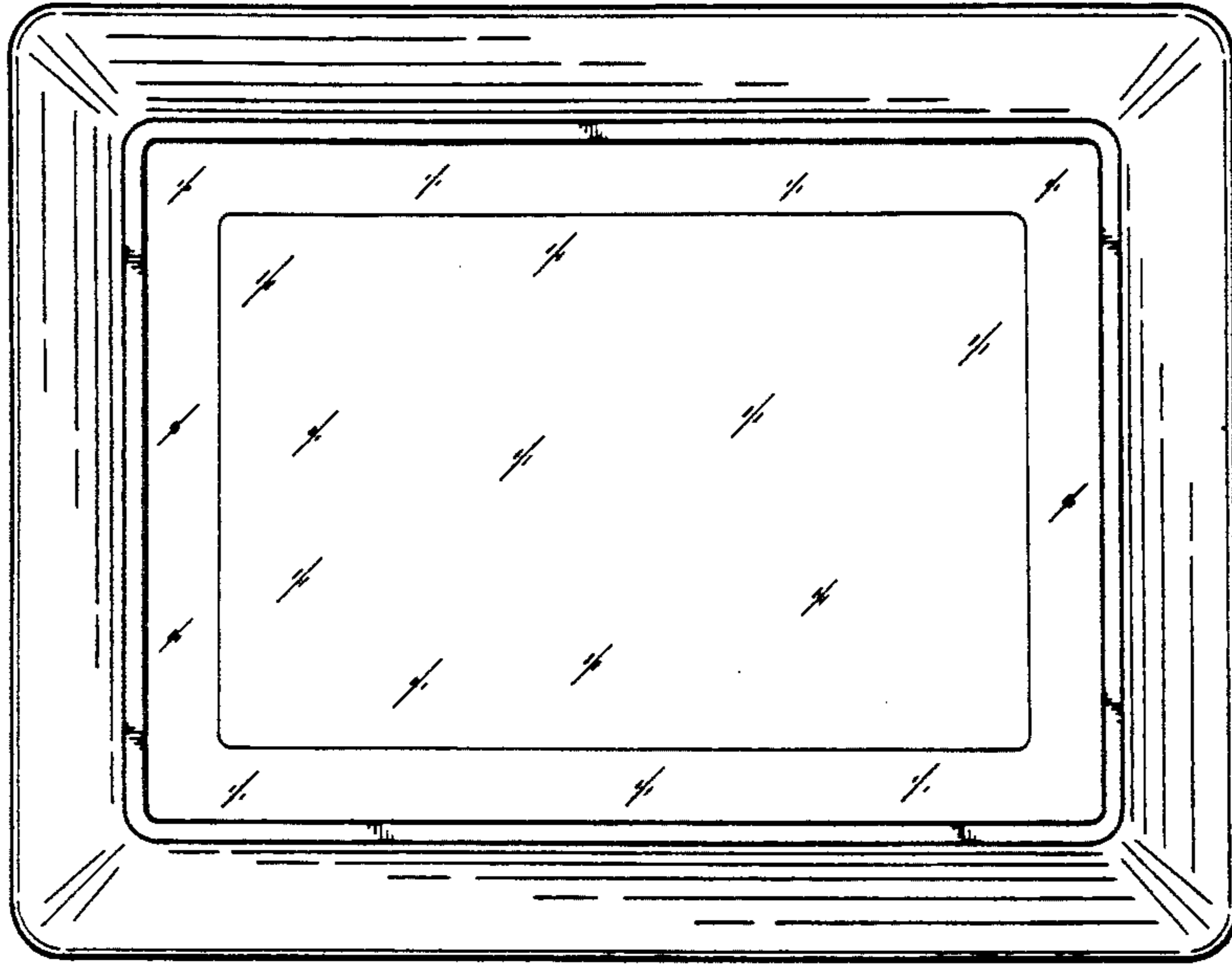

Fig. 8



Fig. 9

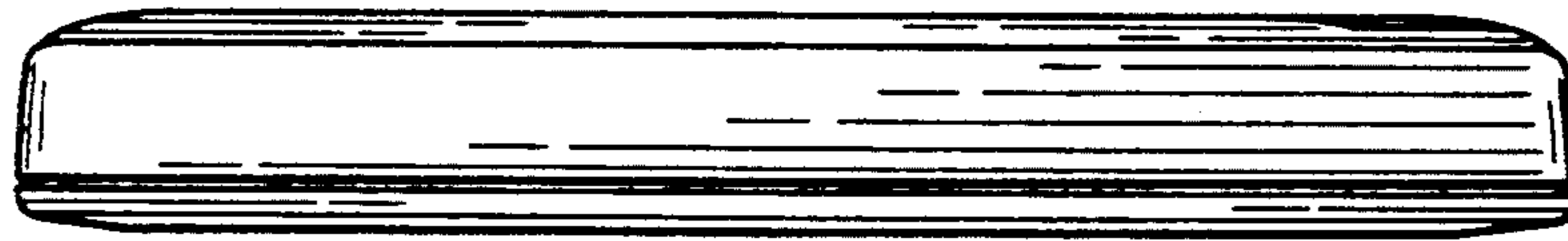

Fig. 11

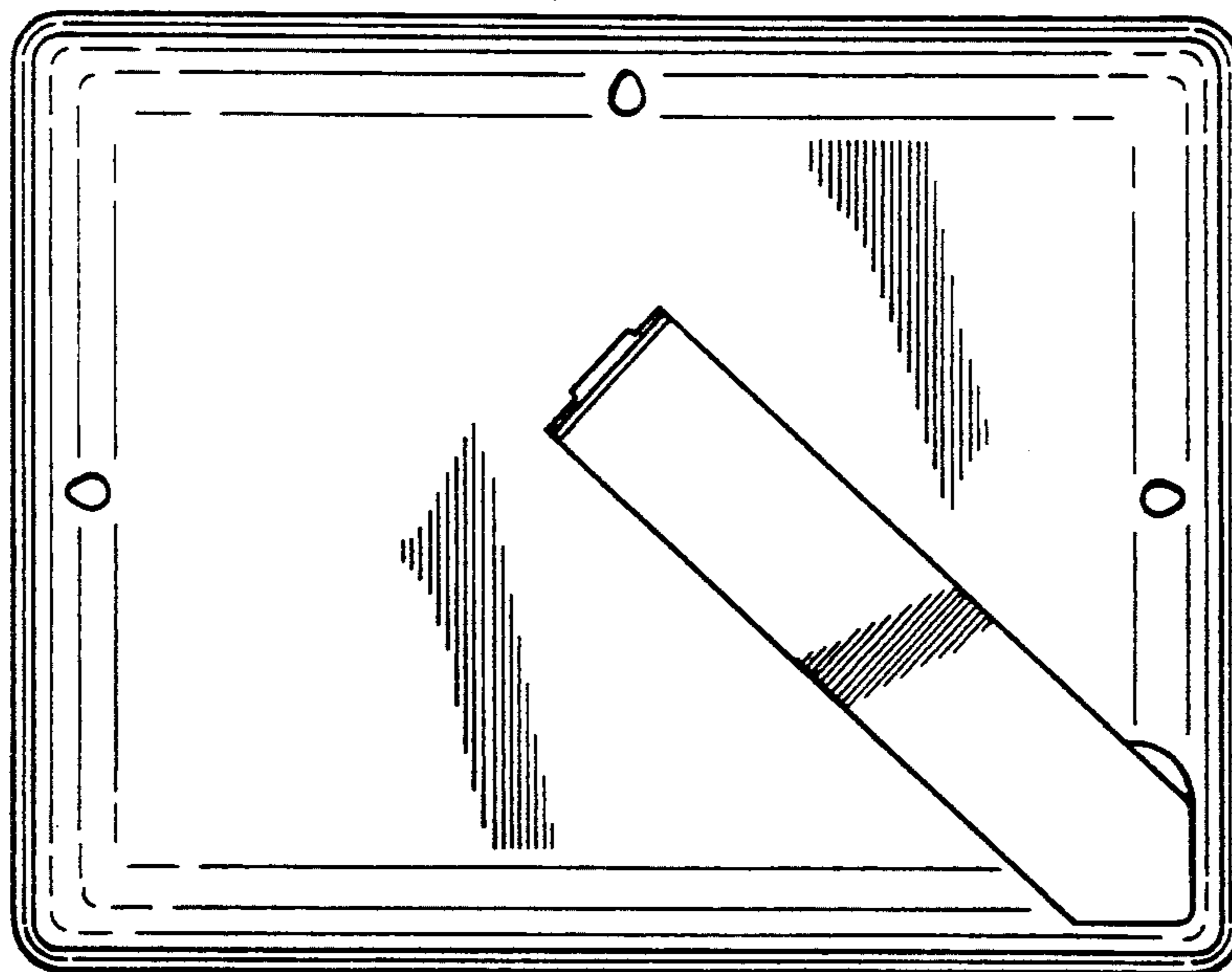

Fig. 10

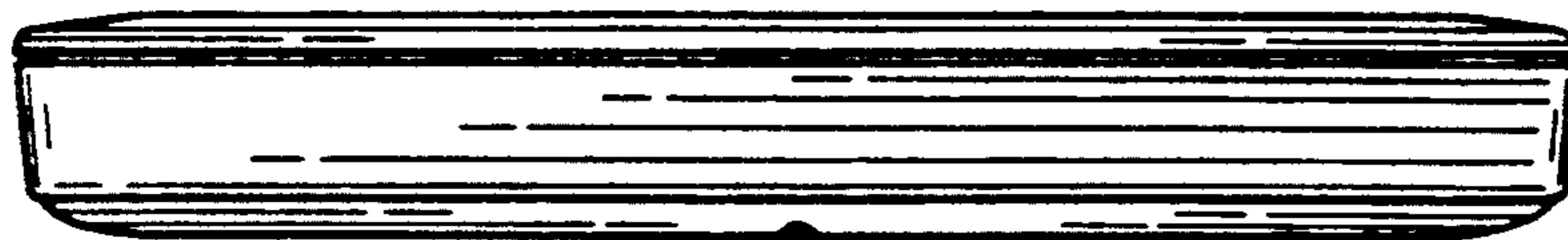

Fig. 12

Fig. 13

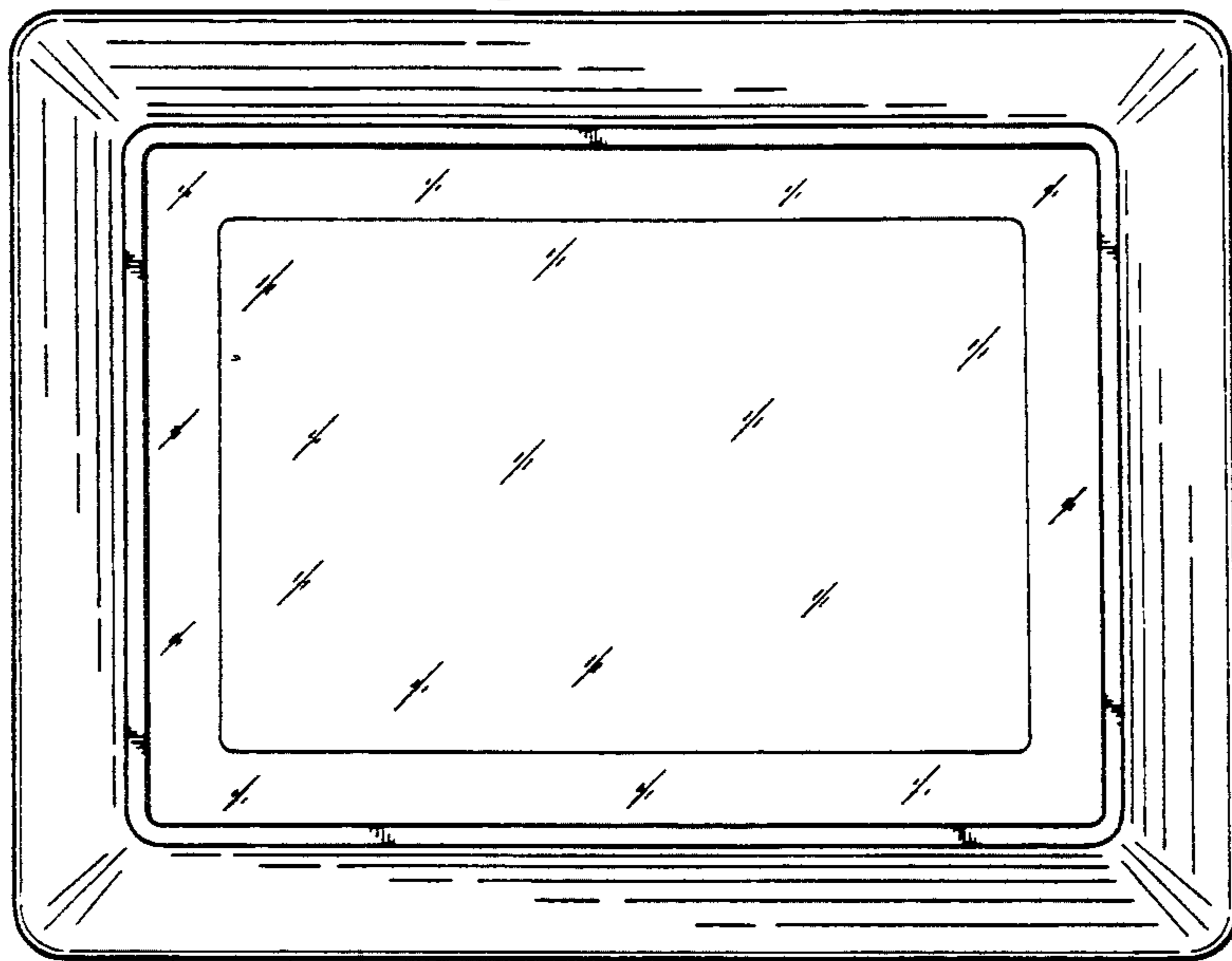

Fig. 14

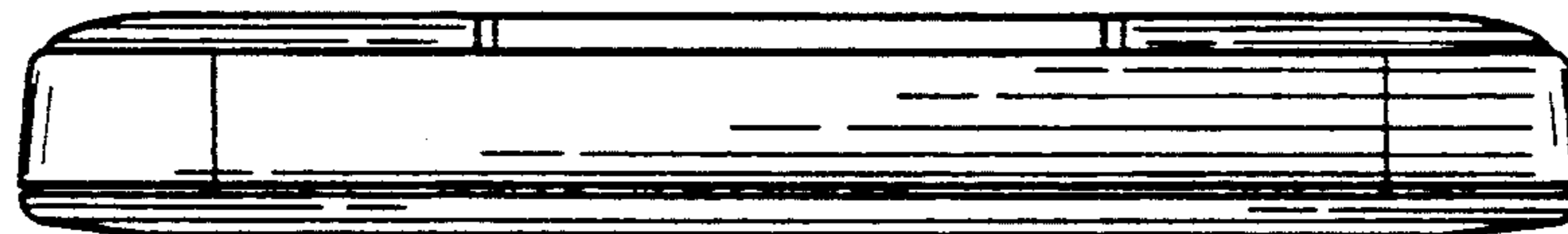
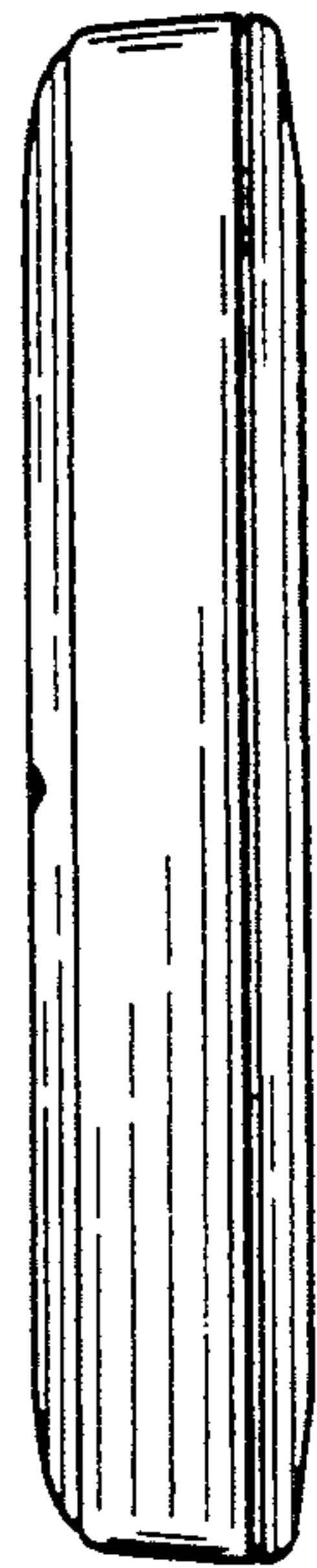

Fig. 15



Fig. 17

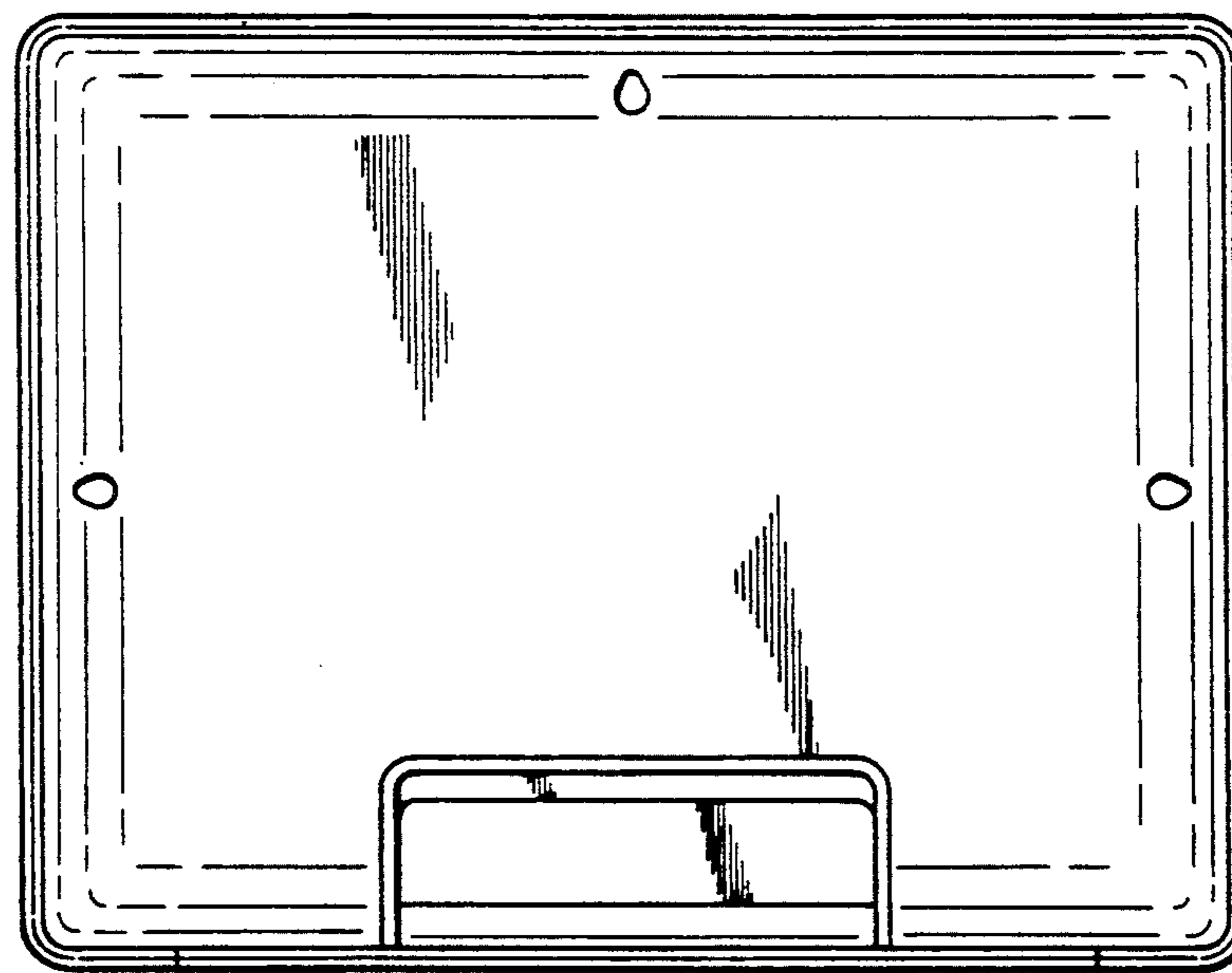

Fig. 16

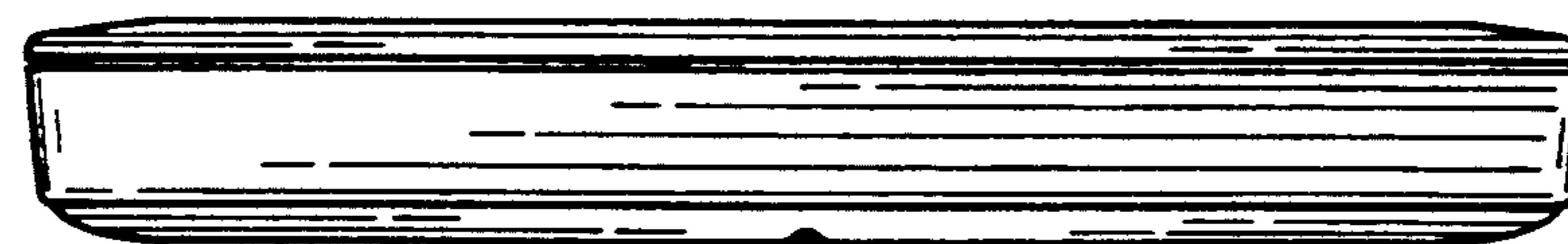

Fig. 18

Fig. 19

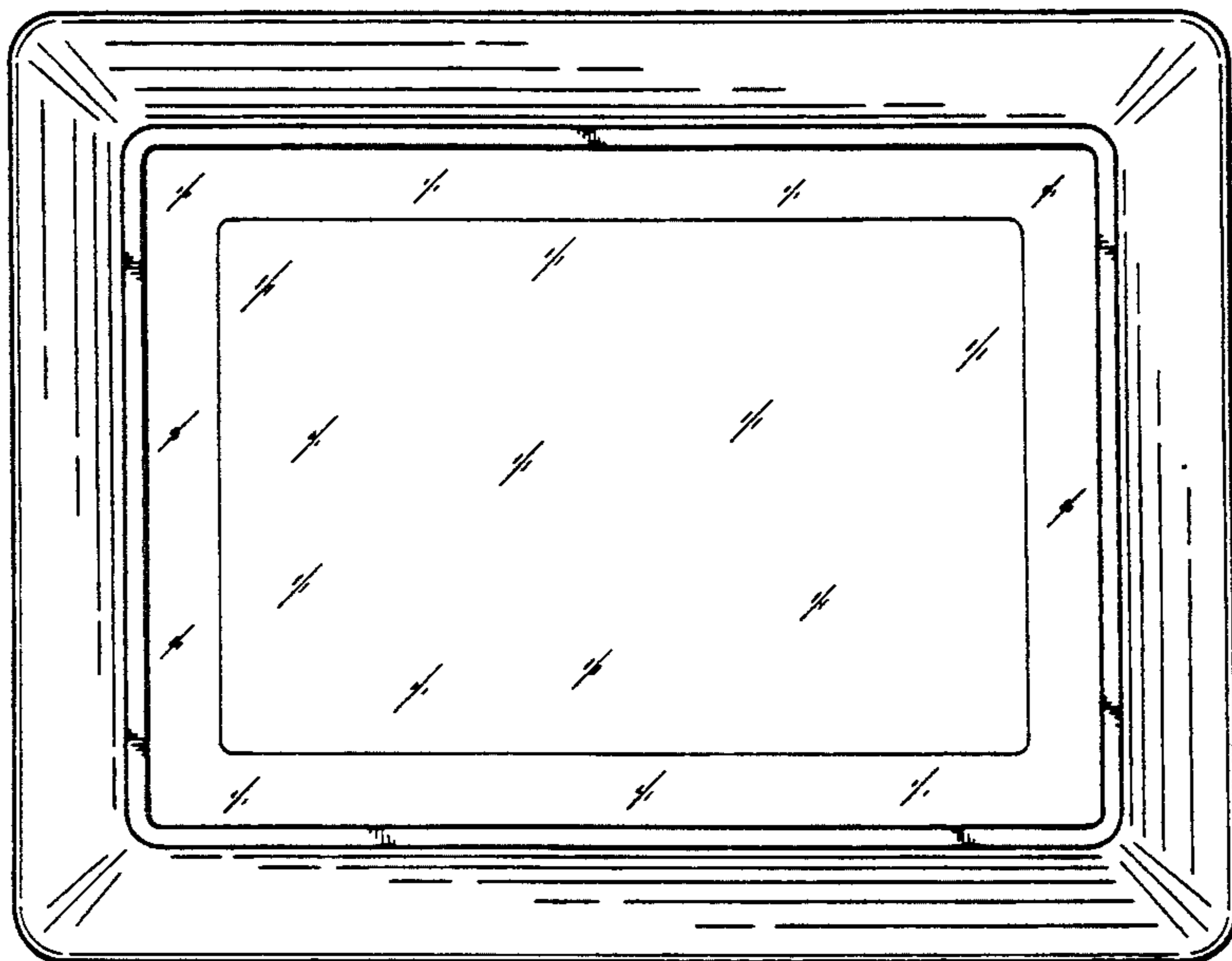

Fig. 20

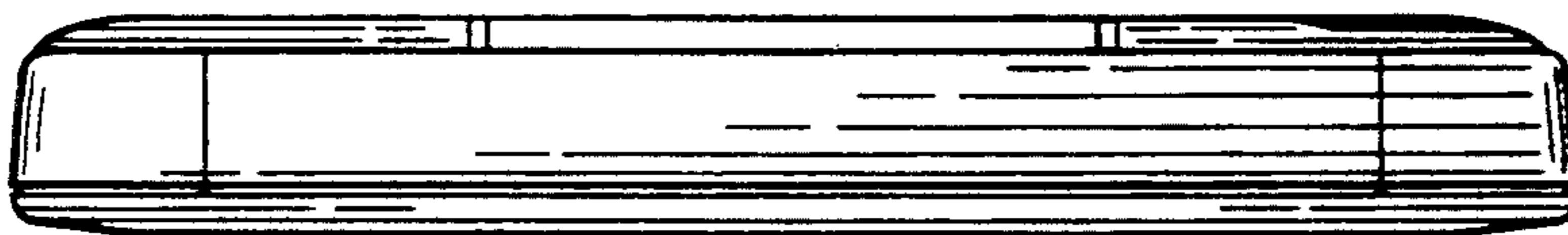

Fig. 21

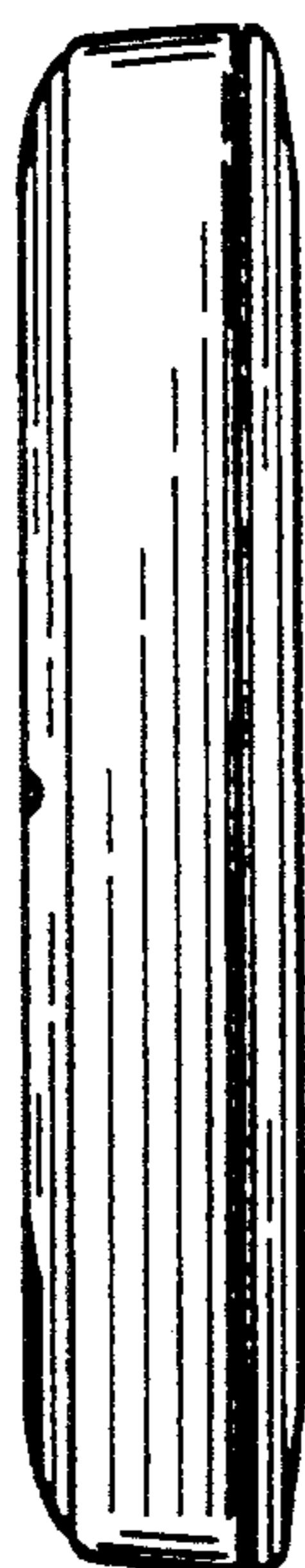

Fig. 23

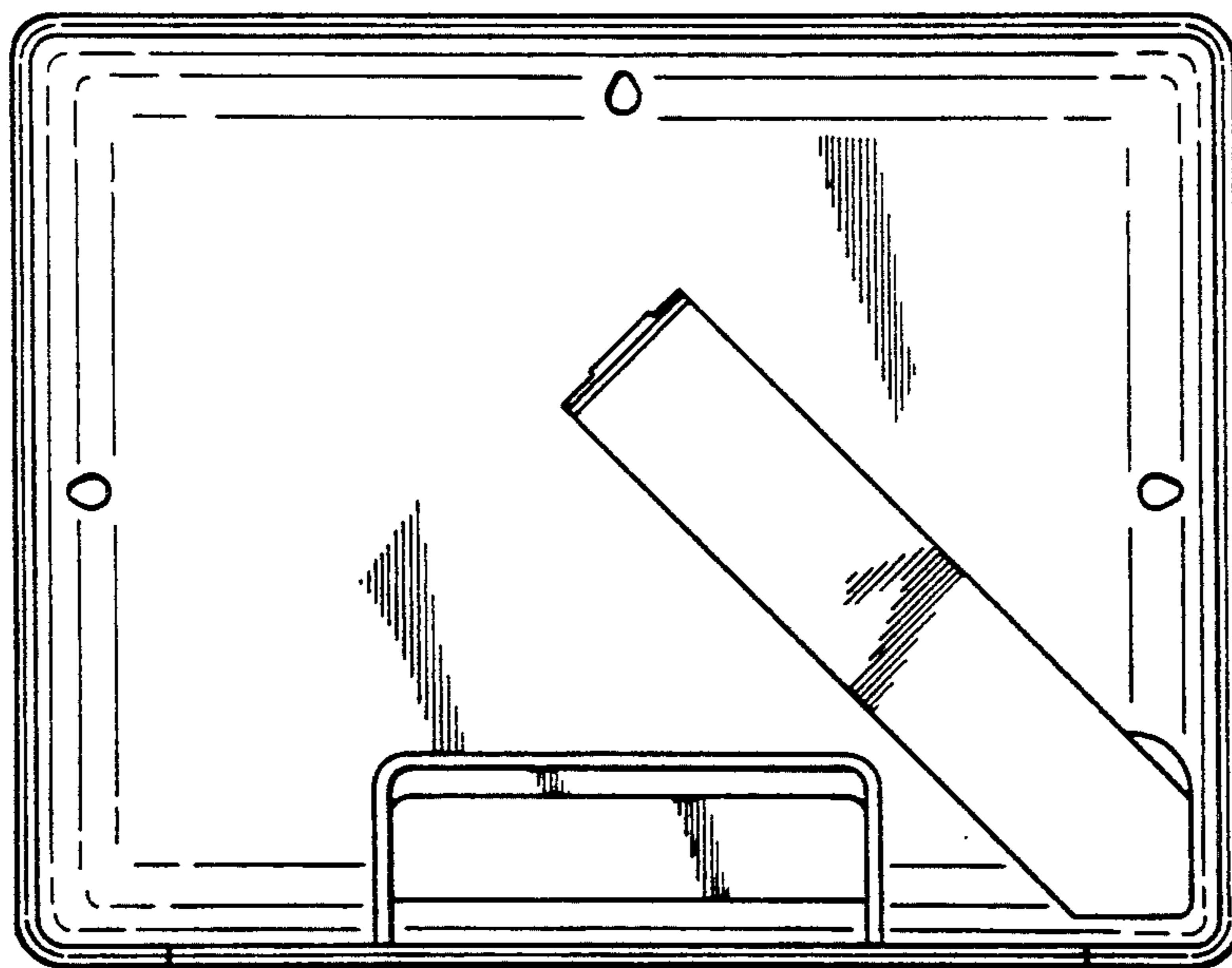

Fig. 22

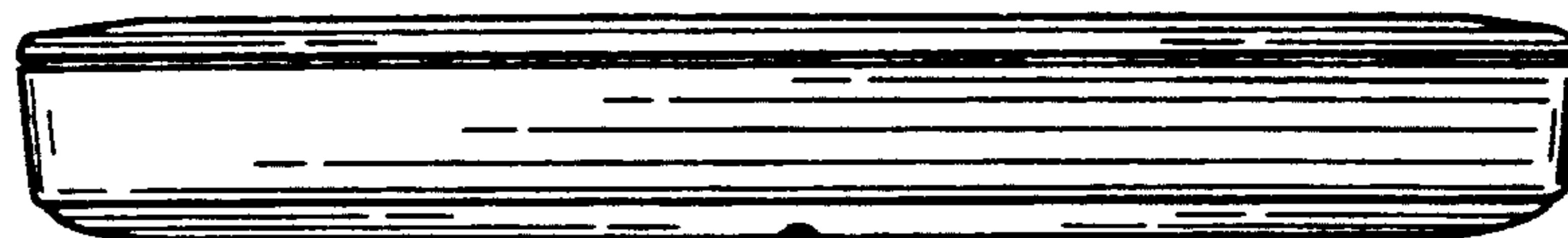

Fig. 24

Fig. 25

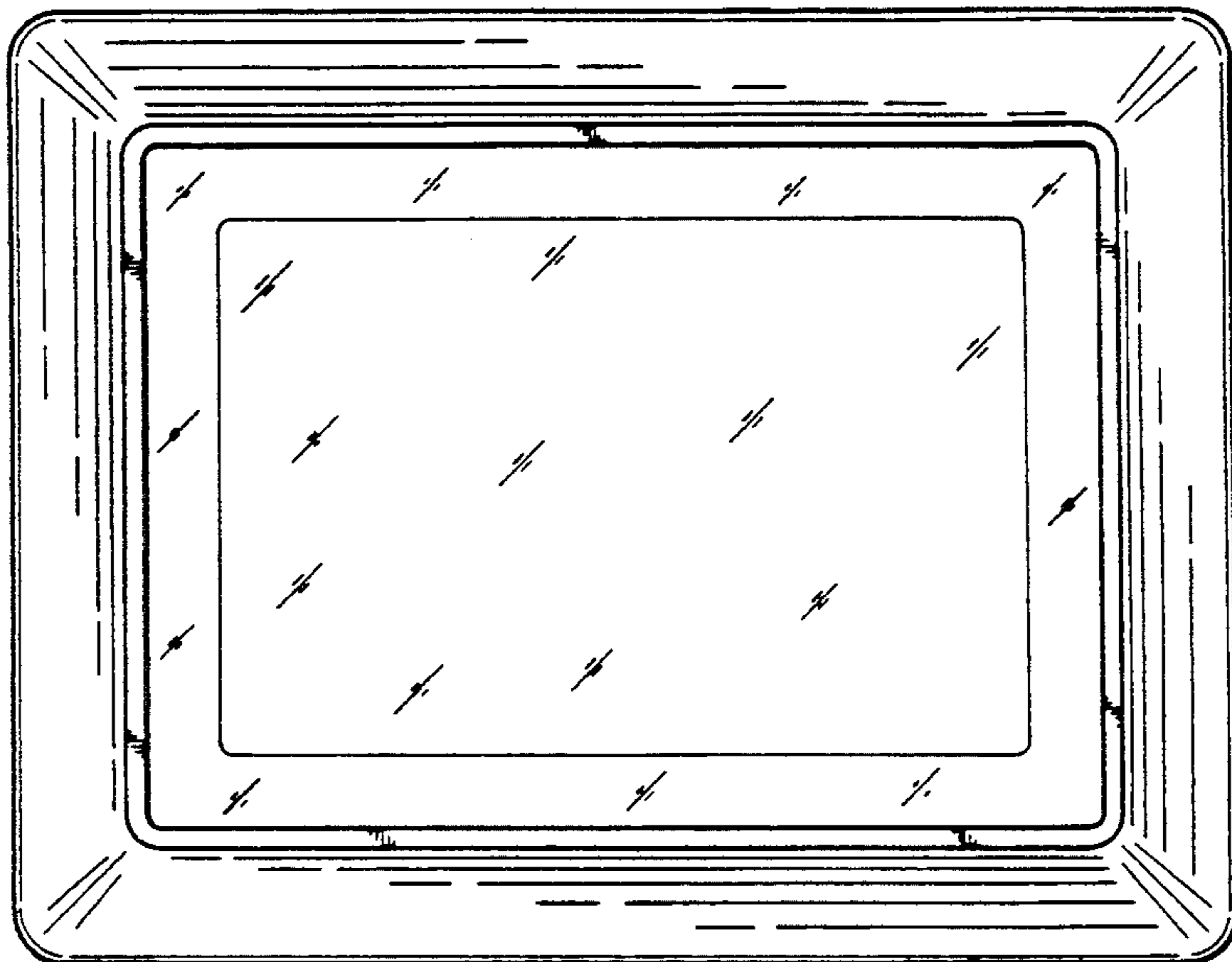

Fig. 26

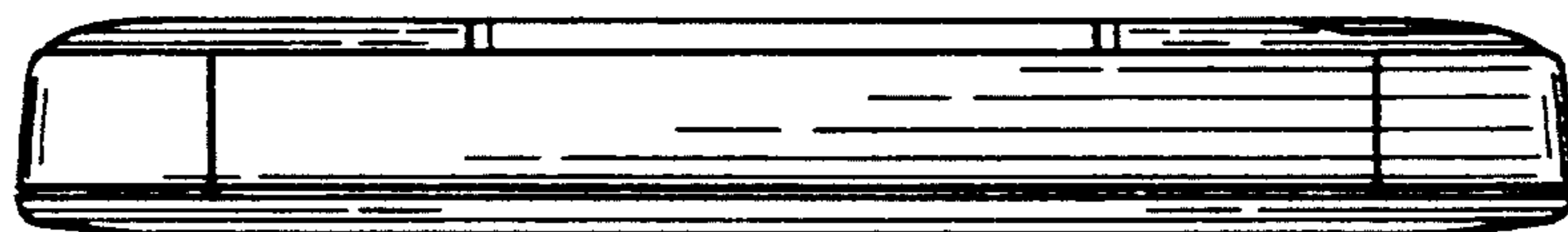

Fig. 27



Fig. 29

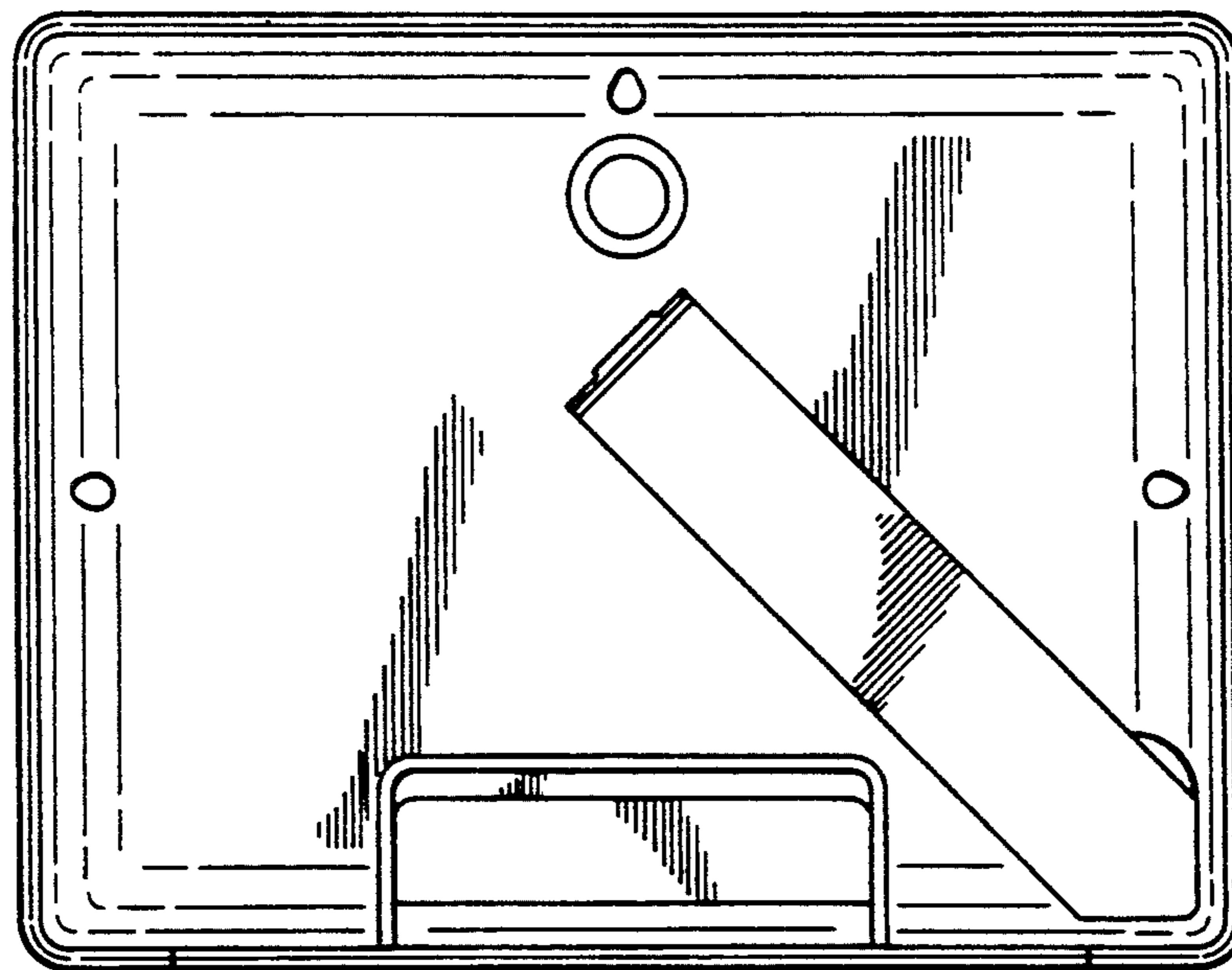

Fig. 28

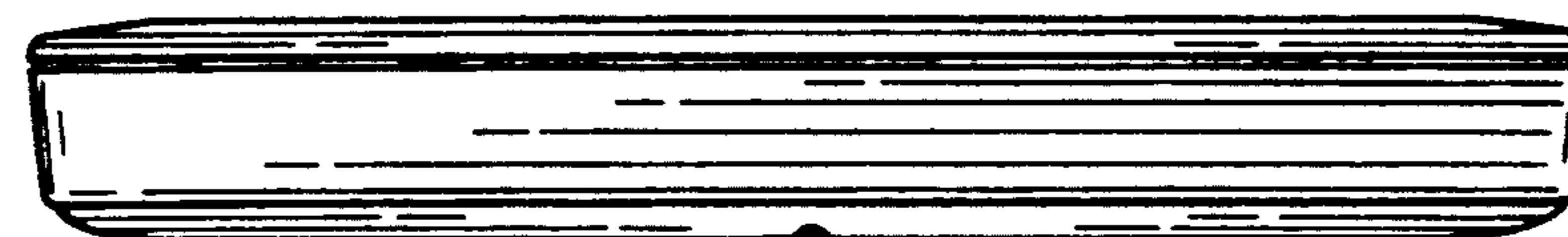

Fig. 30

Fig. 31

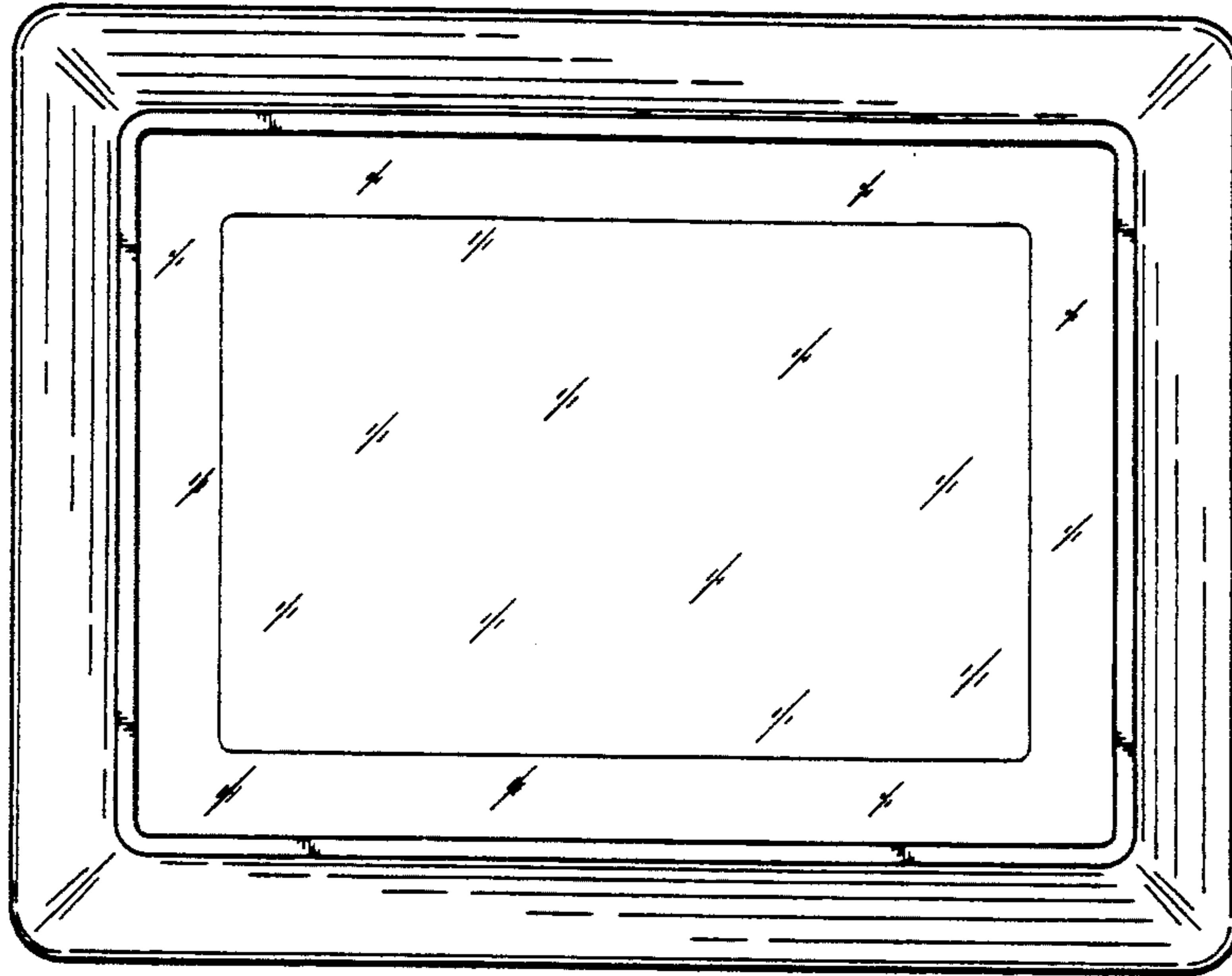

Fig. 32

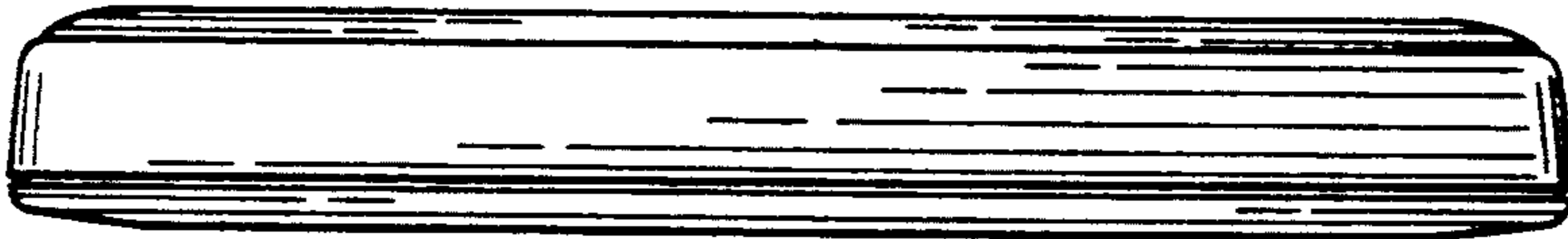
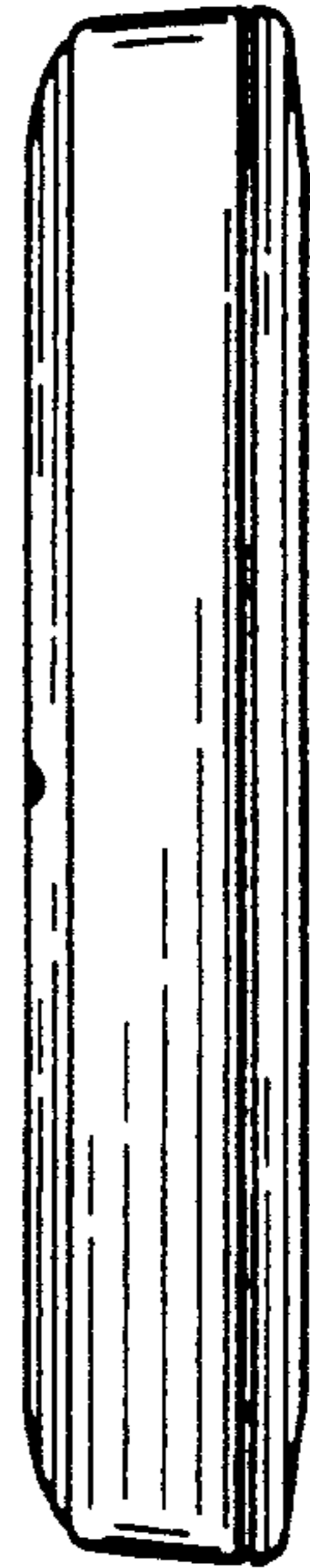

Fig. 33



Fig. 35

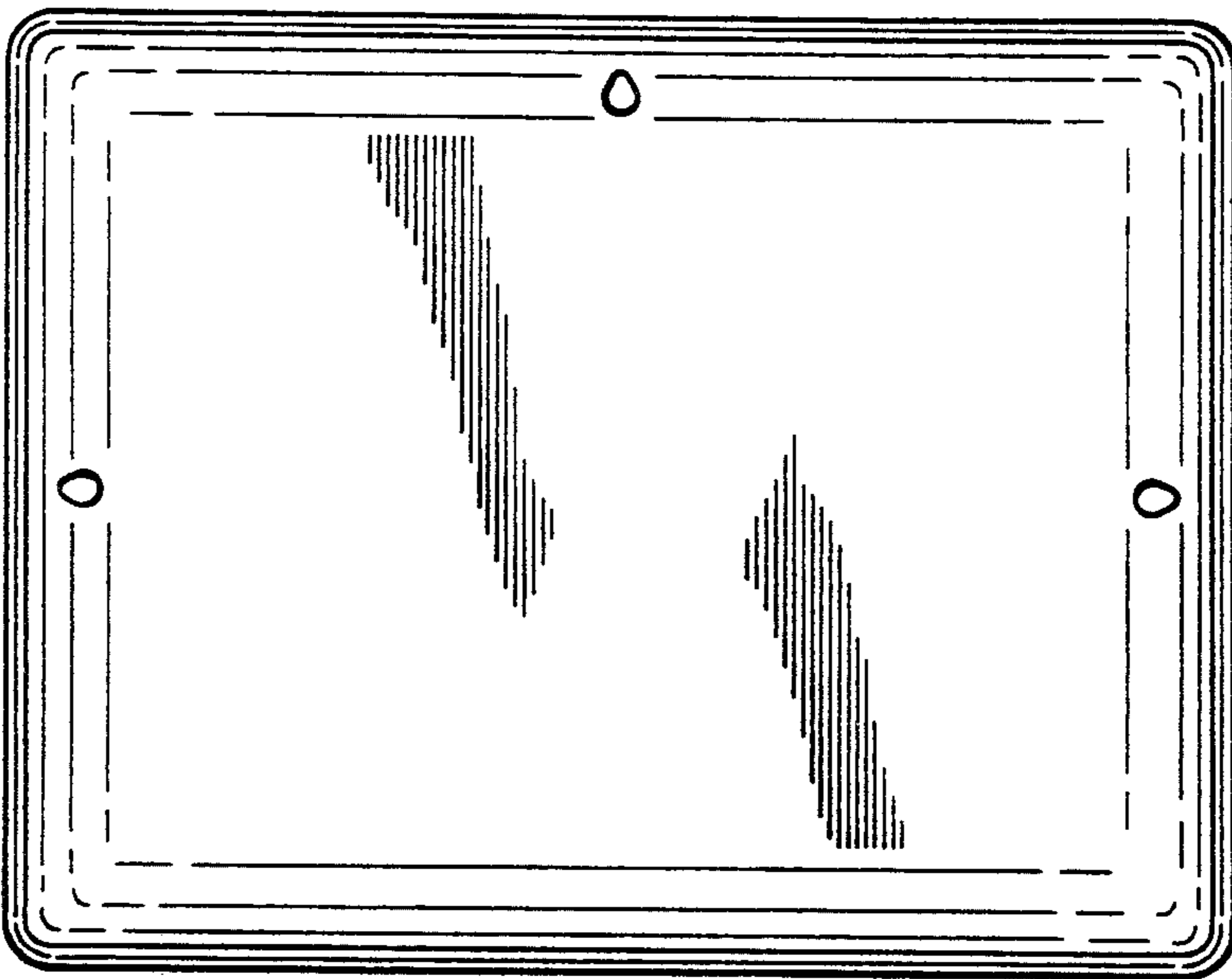

Fig. 34

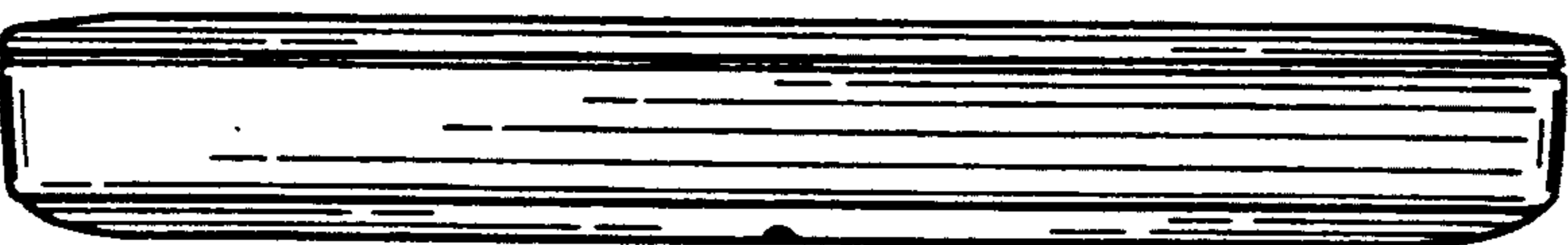

Fig. 36

Fig. 37

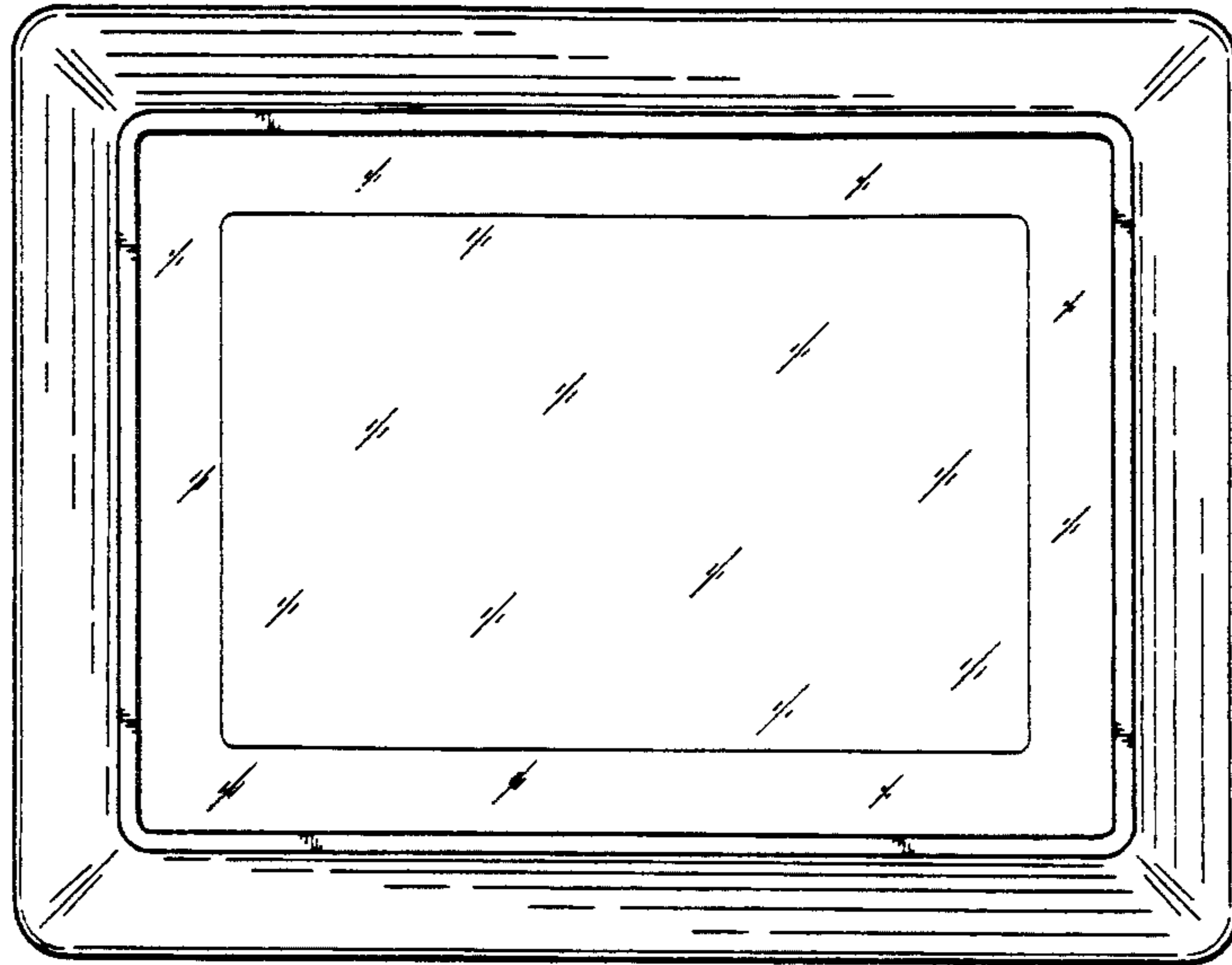

Fig. 38



Fig. 39

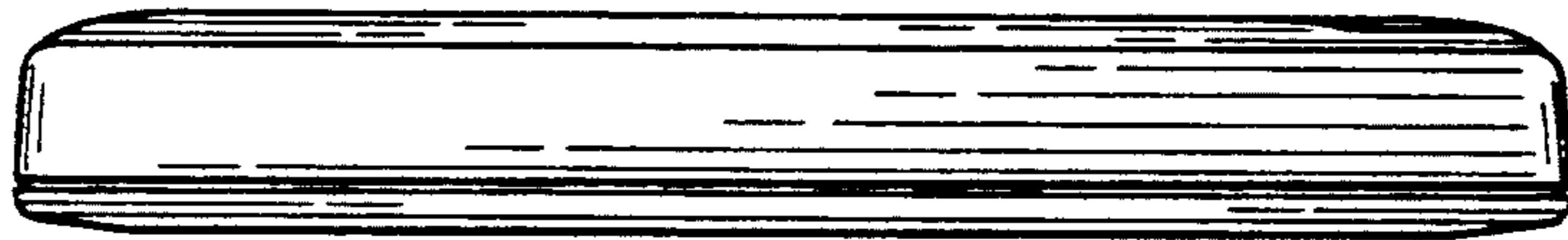

Fig. 40

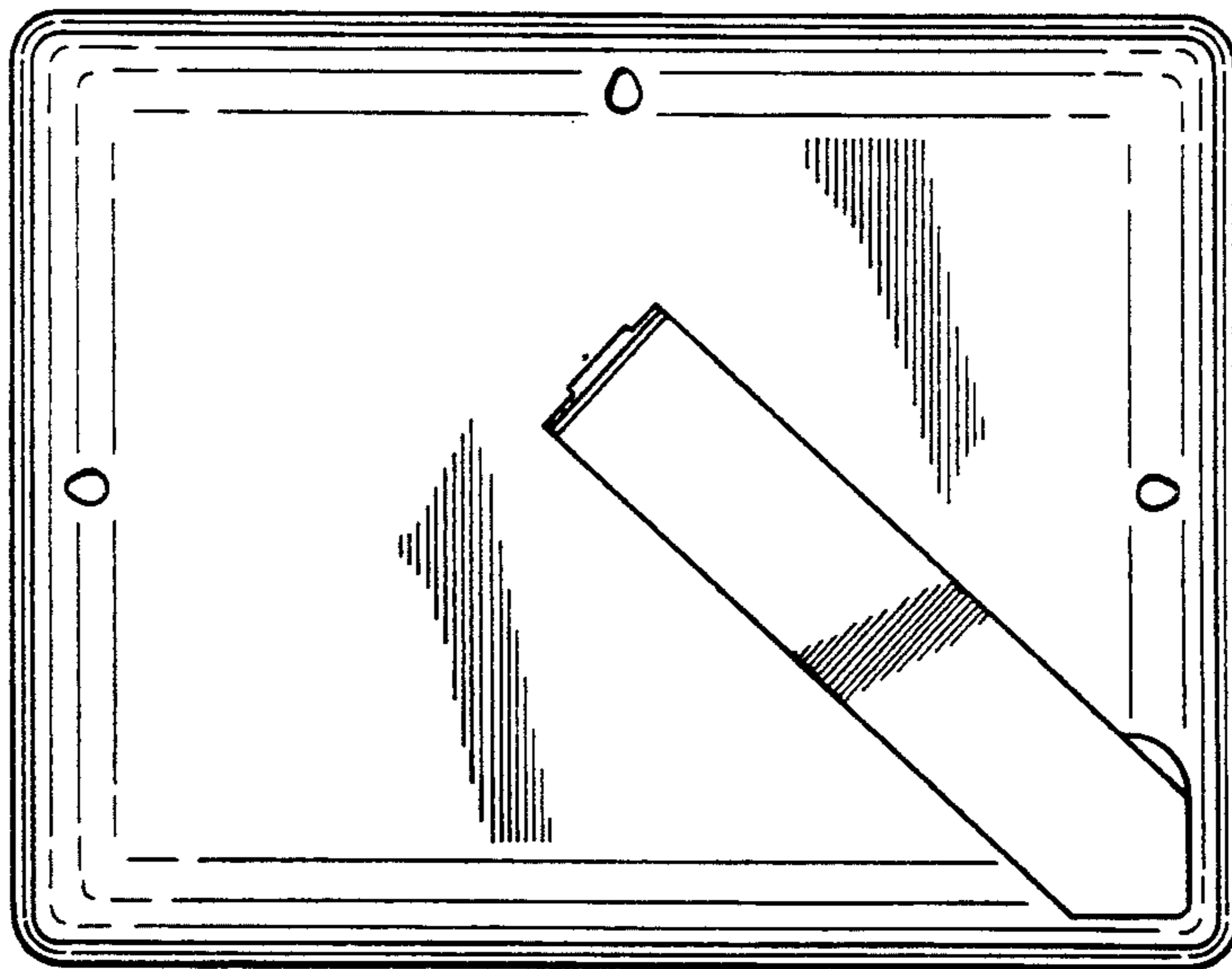

Fig. 41



Fig. 42

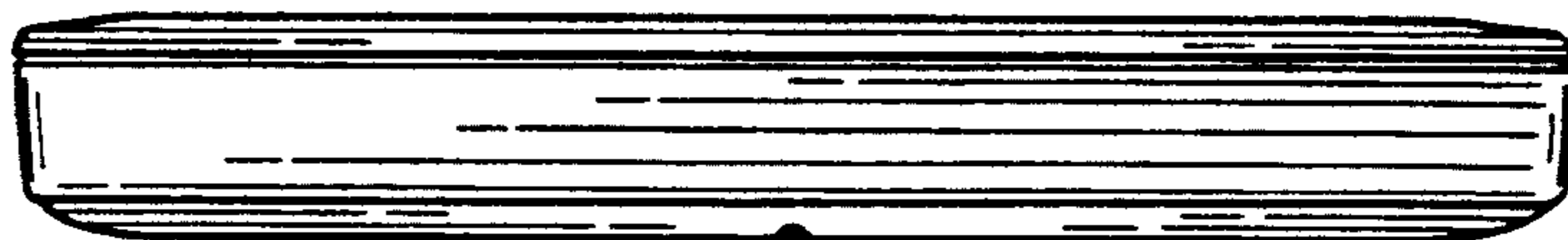

Fig. 43

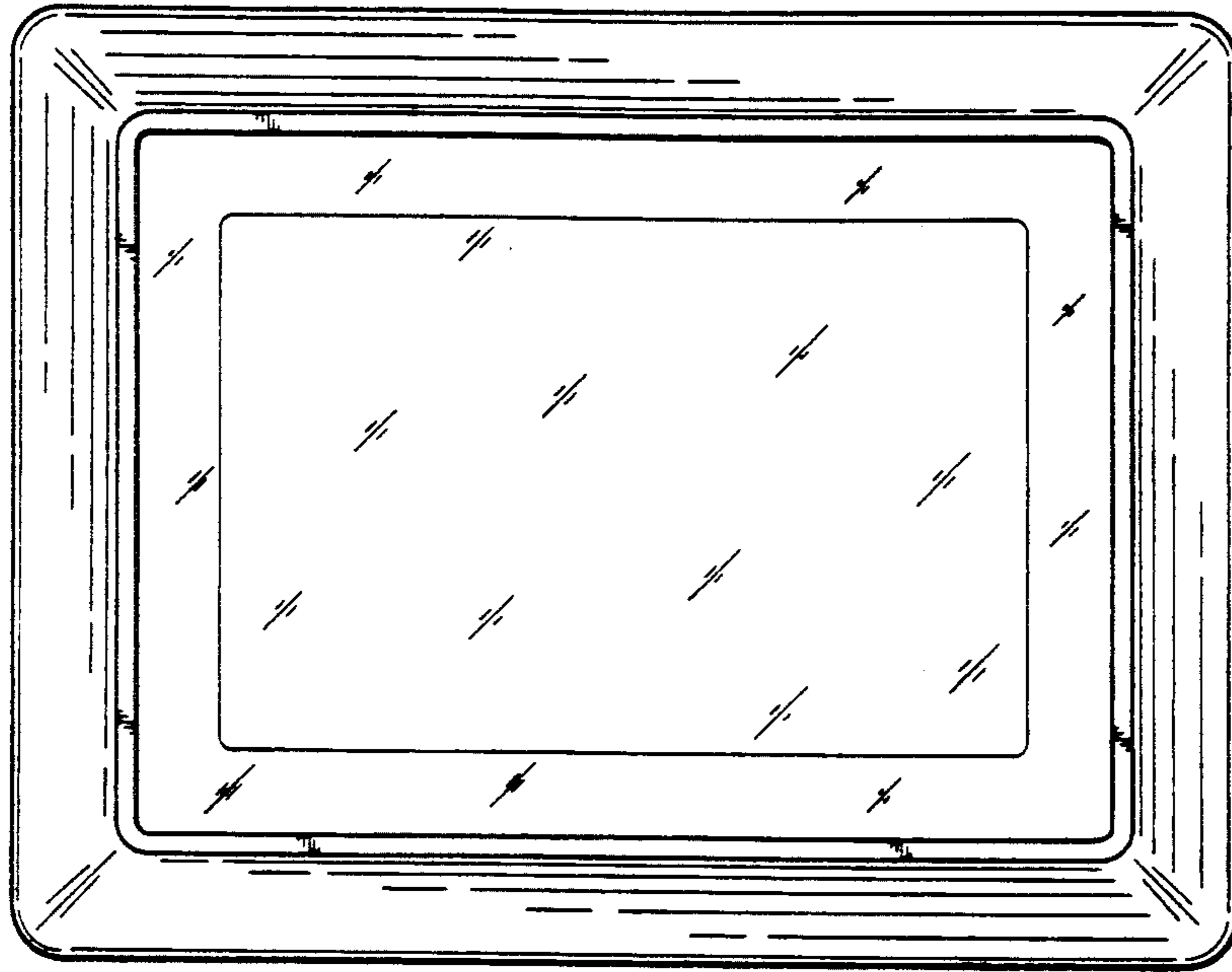

Fig. 44

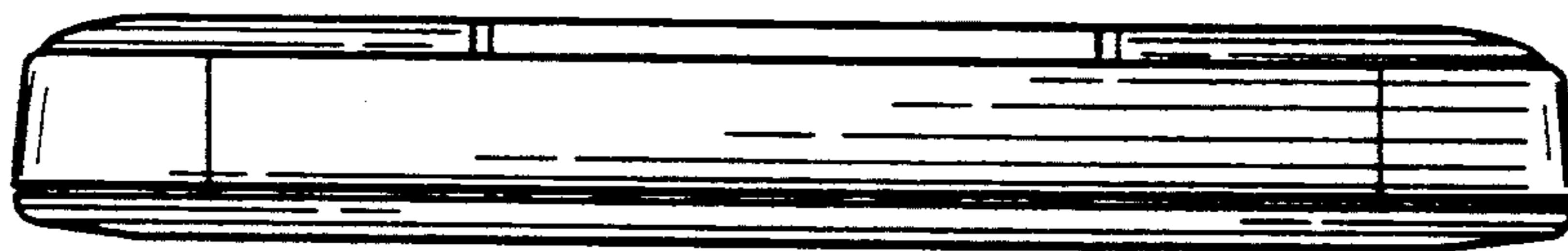
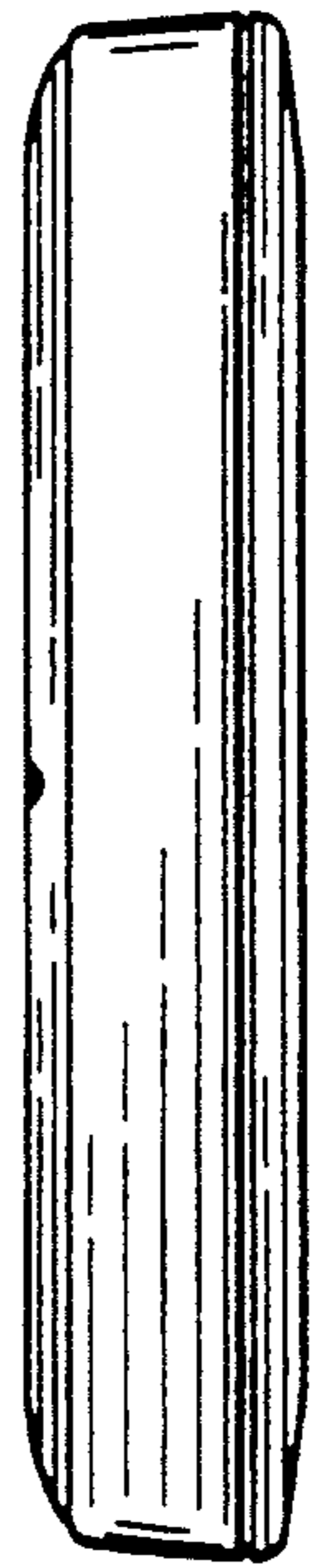

Fig. 45



Fig. 47

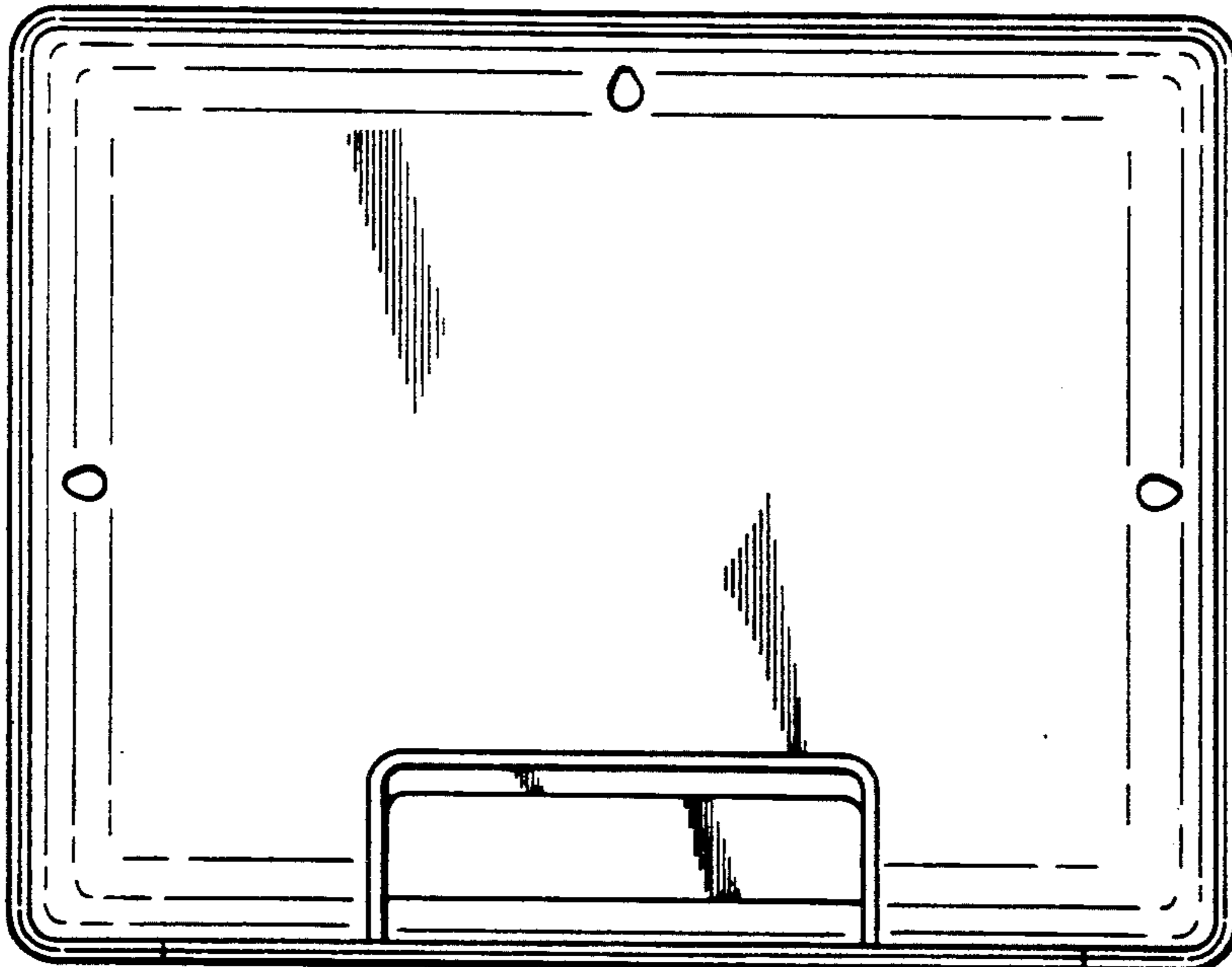

Fig. 46

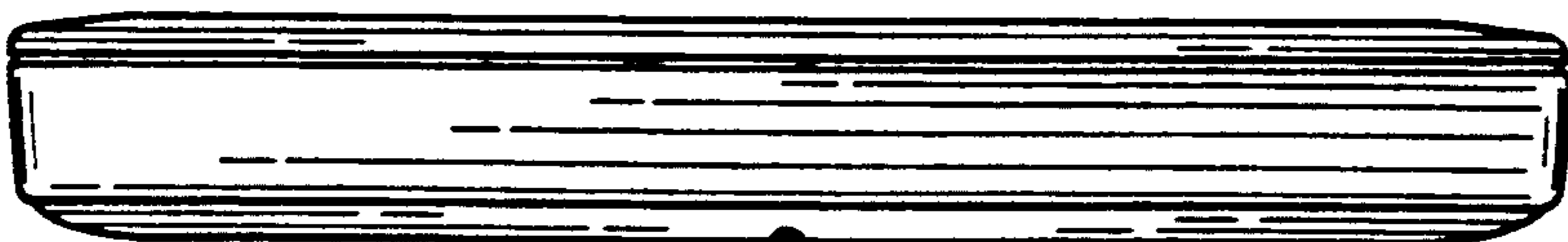

Fig. 48

Fig. 49

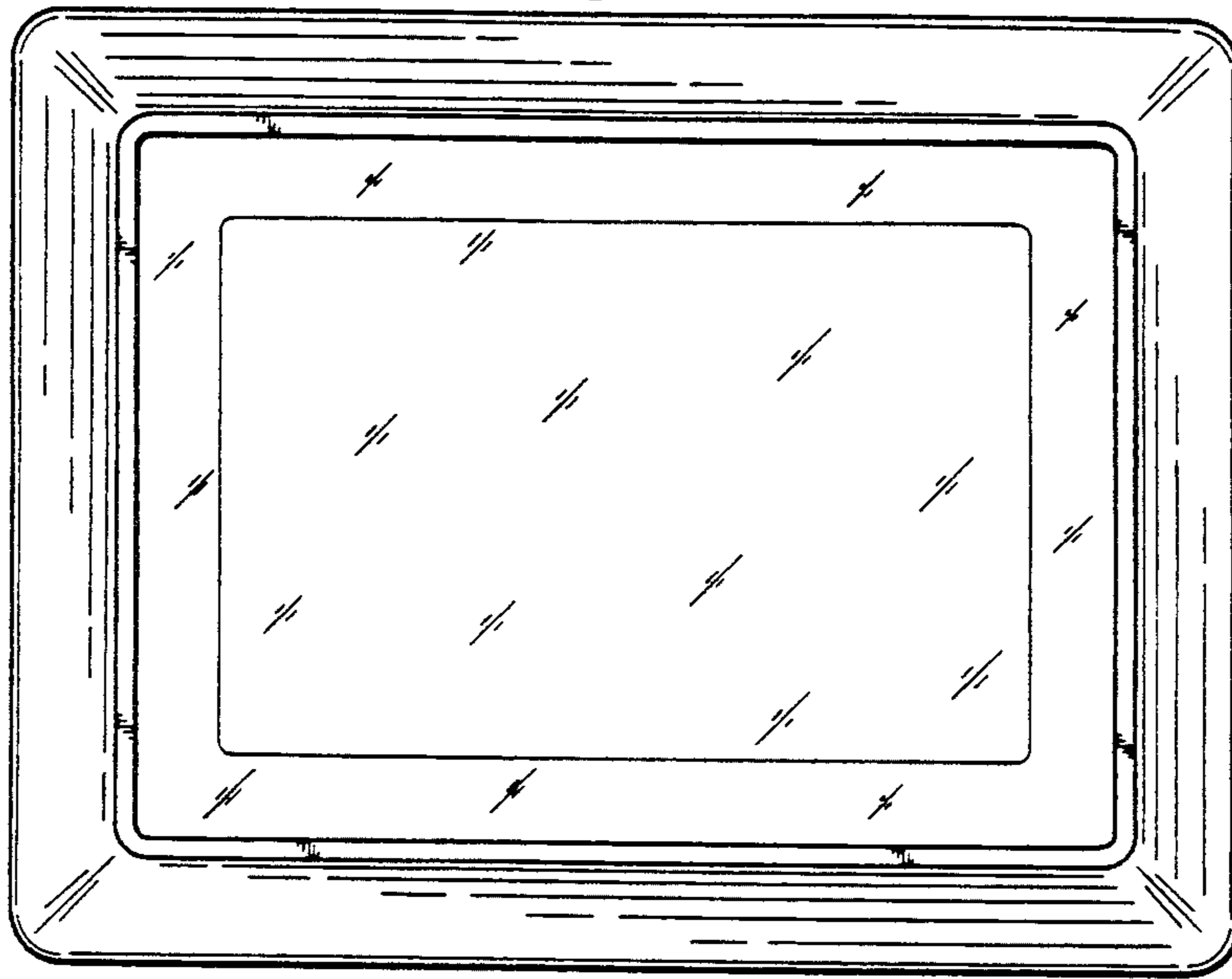

Fig. 50

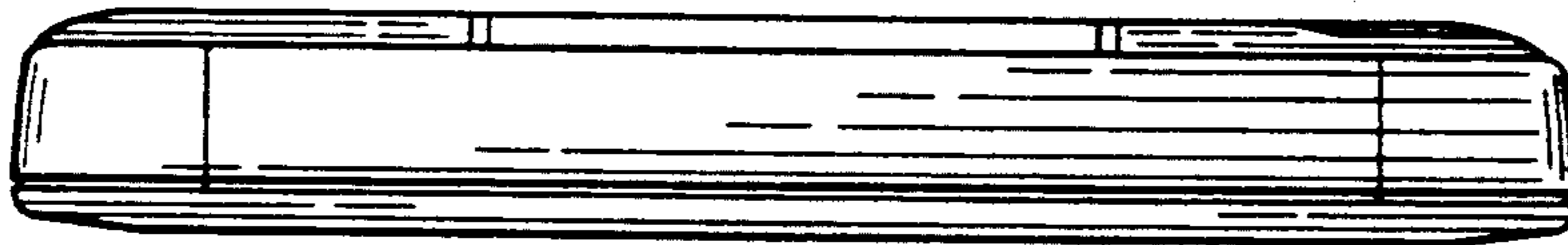

Fig. 51

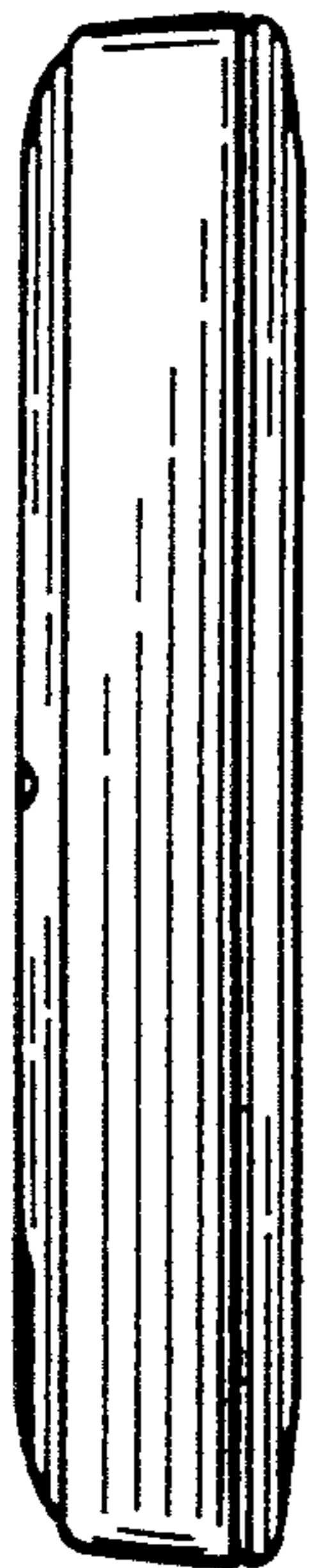

Fig. 53

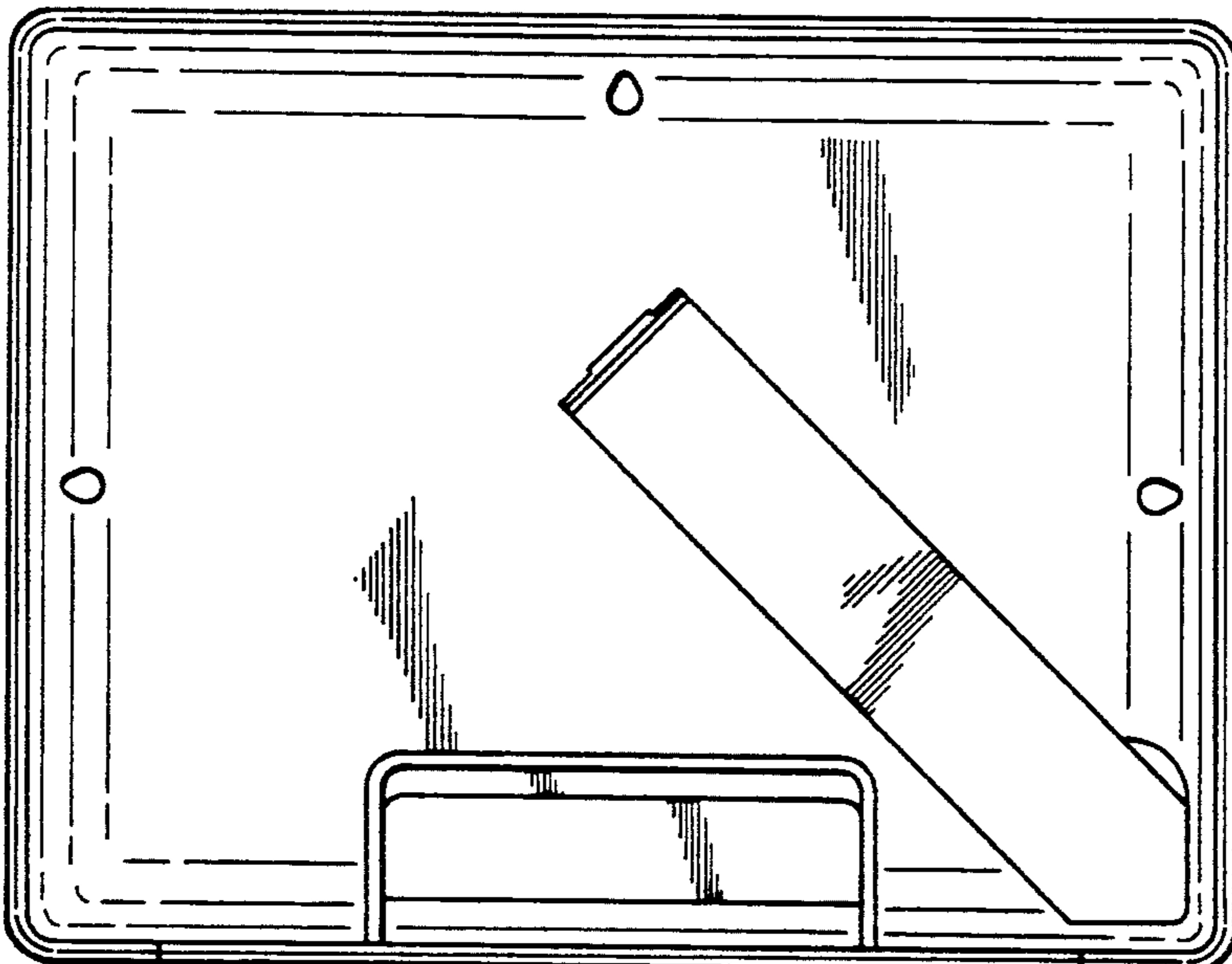

Fig. 52

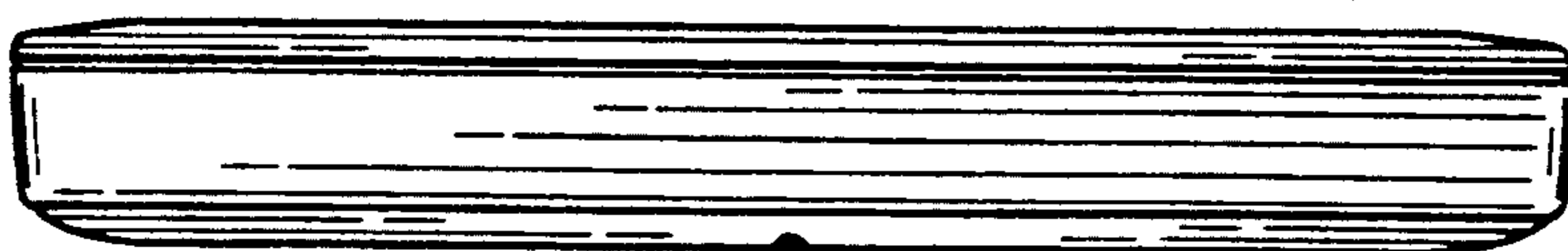

Fig. 54

Fig. 55

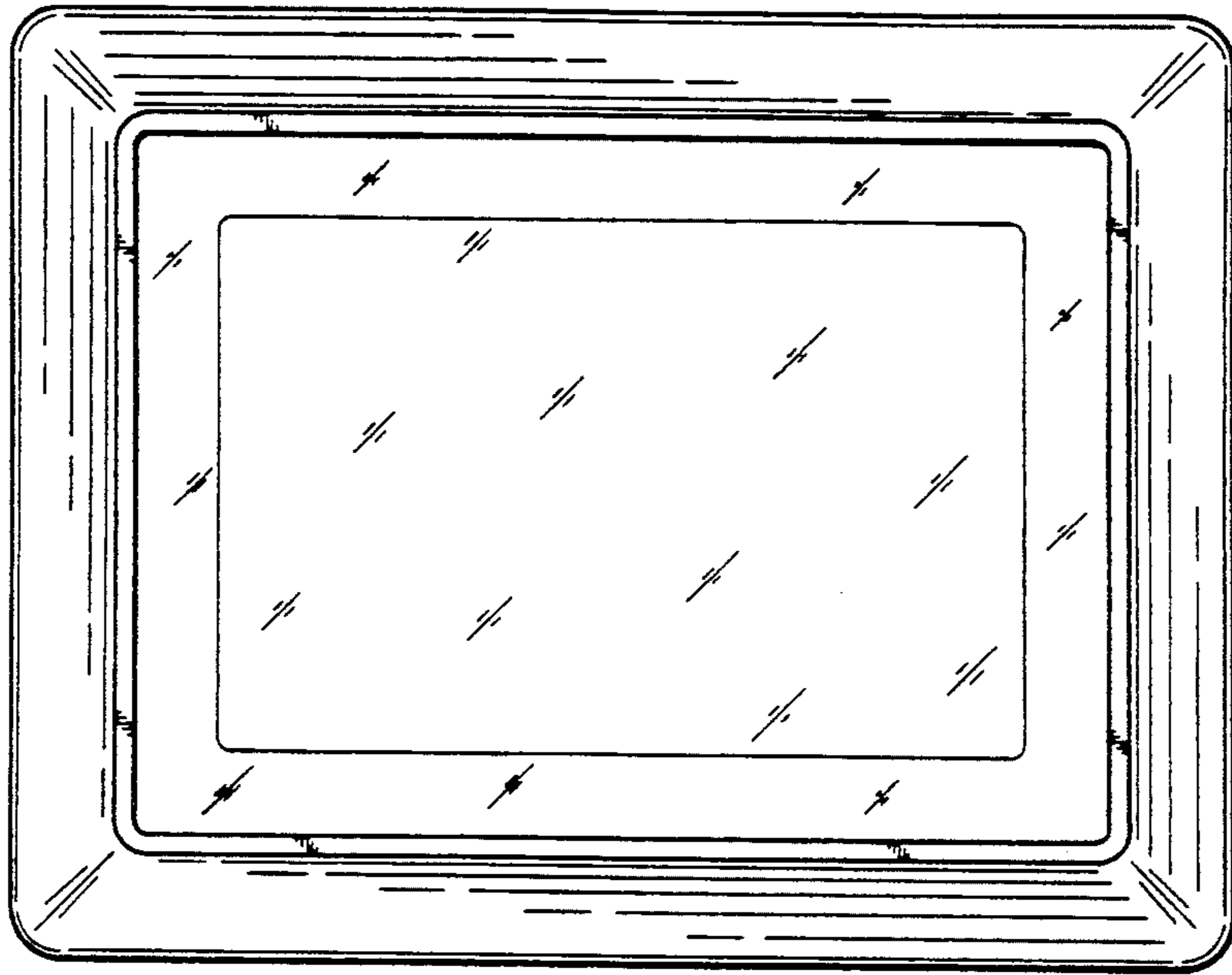

Fig. 56

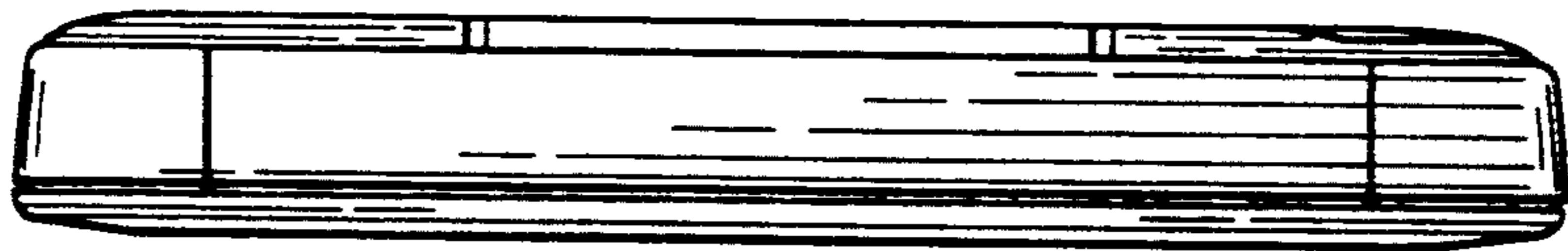

Fig. 57



Fig. 59

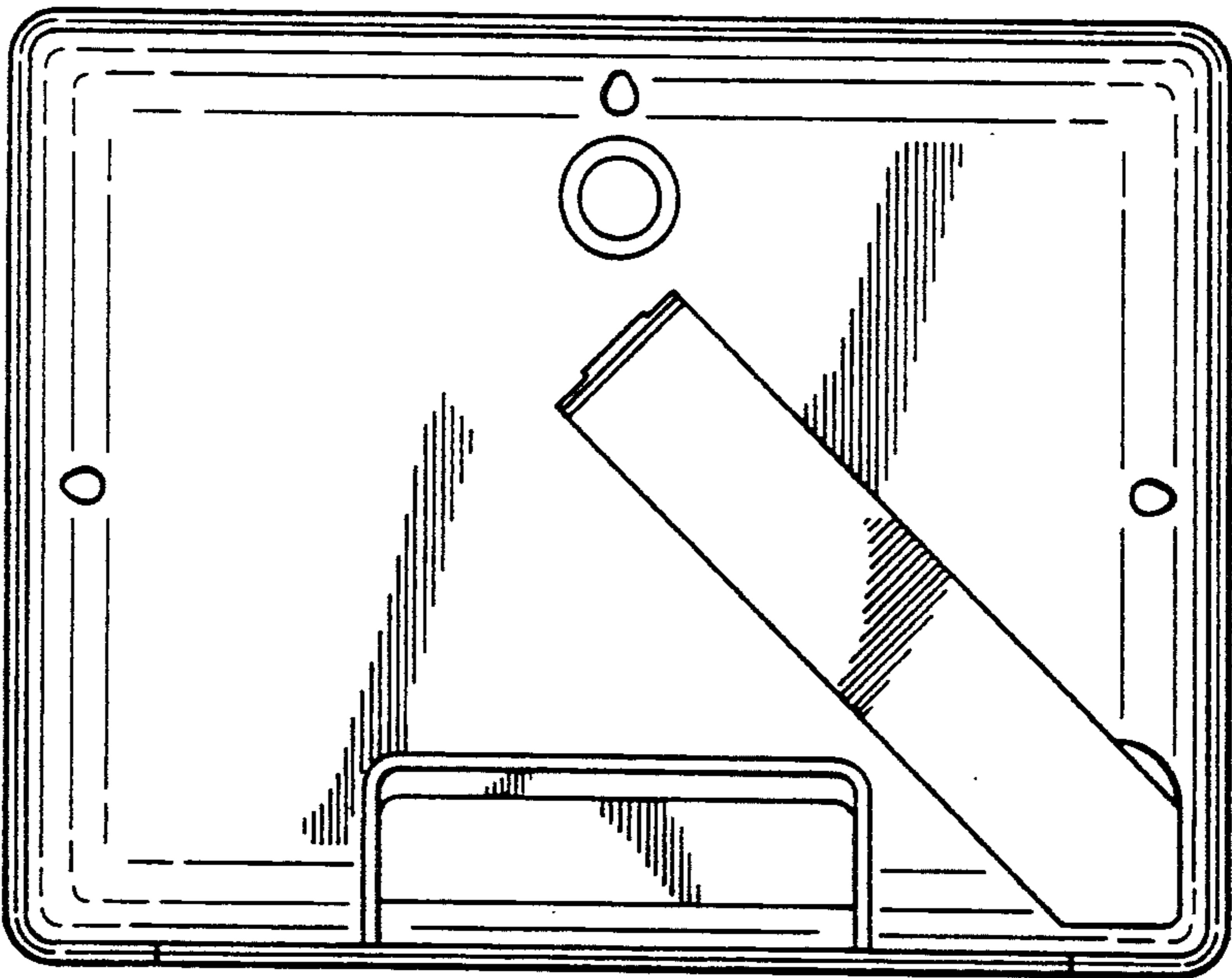

Fig. 58

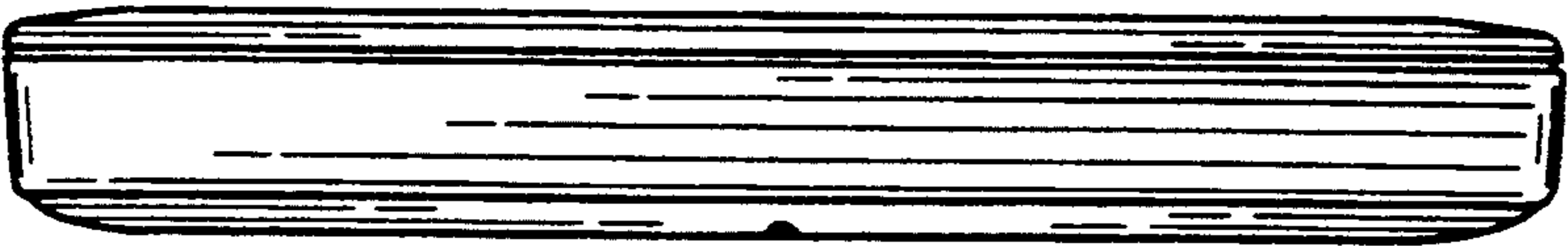

Fig. 60

Fig. 61

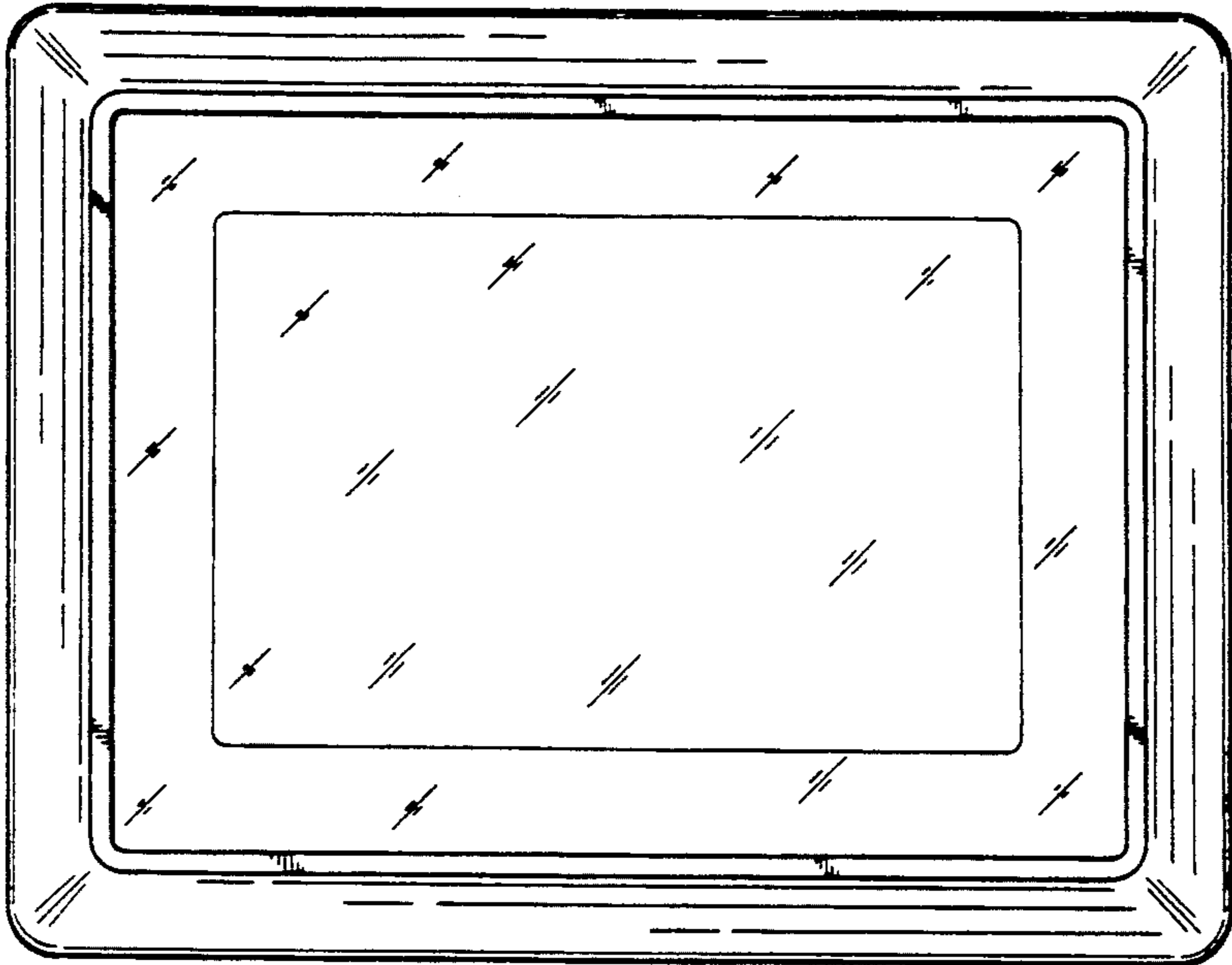

Fig. 62

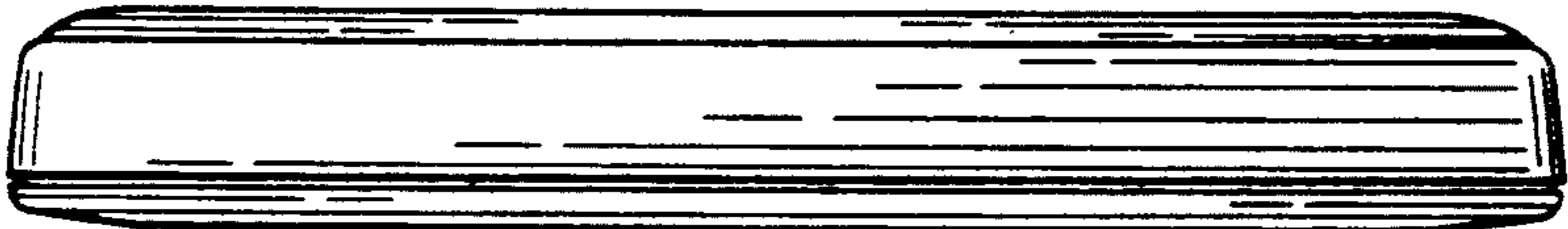

Fig. 63



Fig. 65

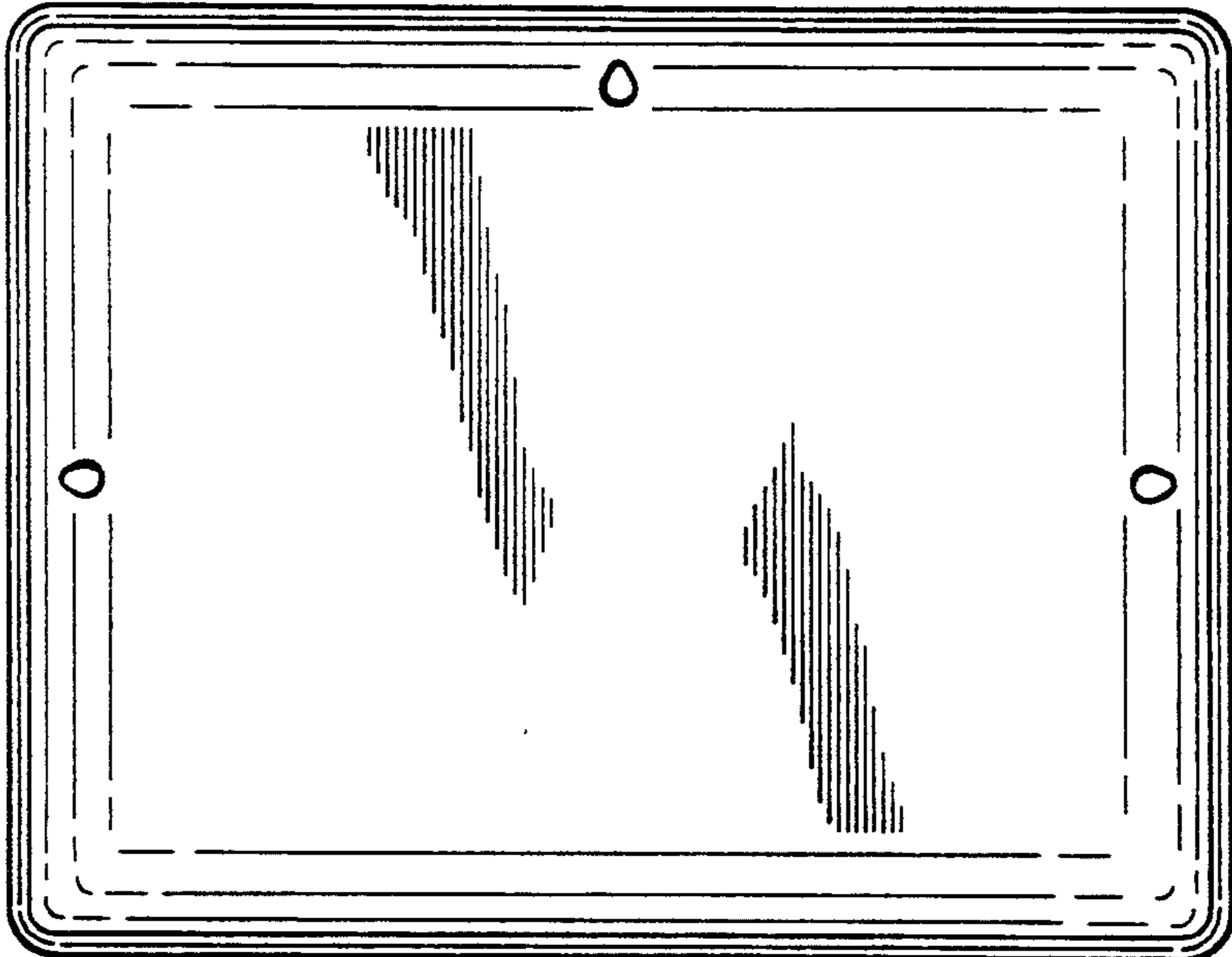

Fig. 64

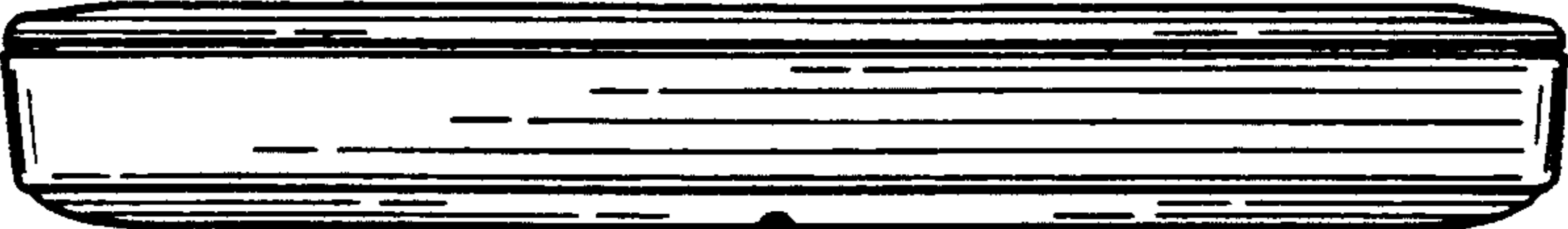

Fig. 66

Fig. 67

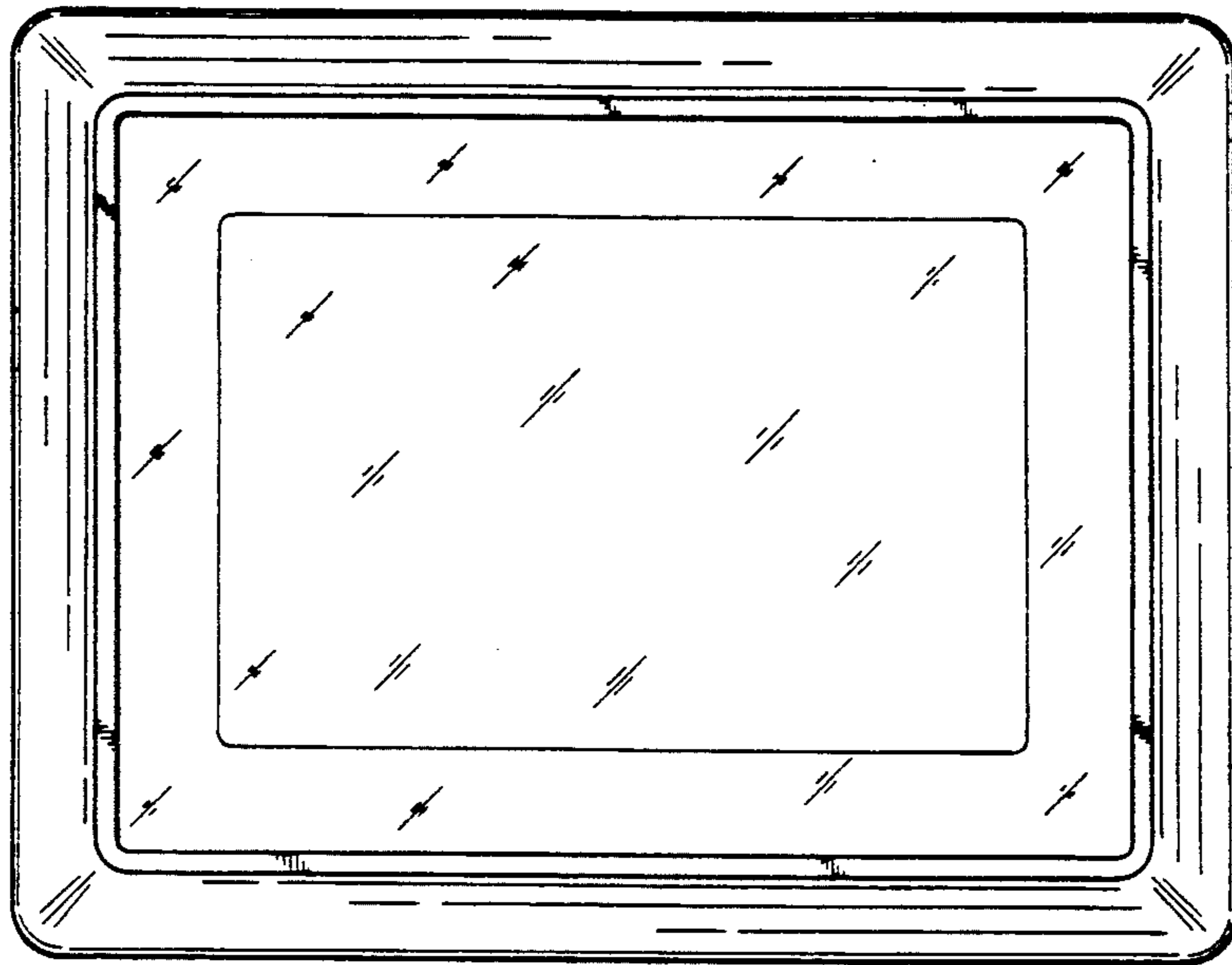

Fig. 68

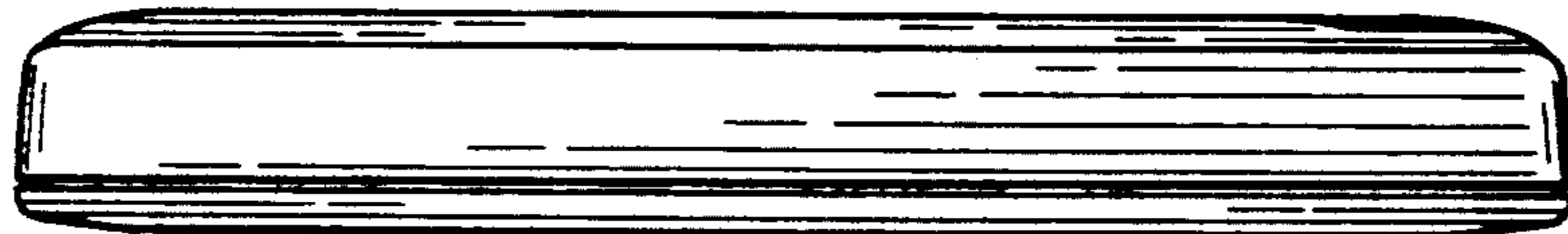
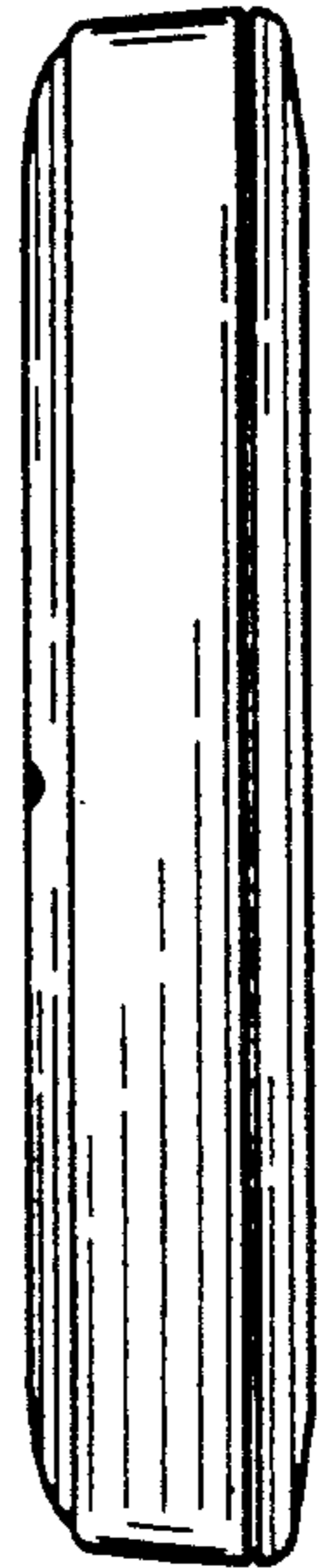

Fig. 69



Fig. 71

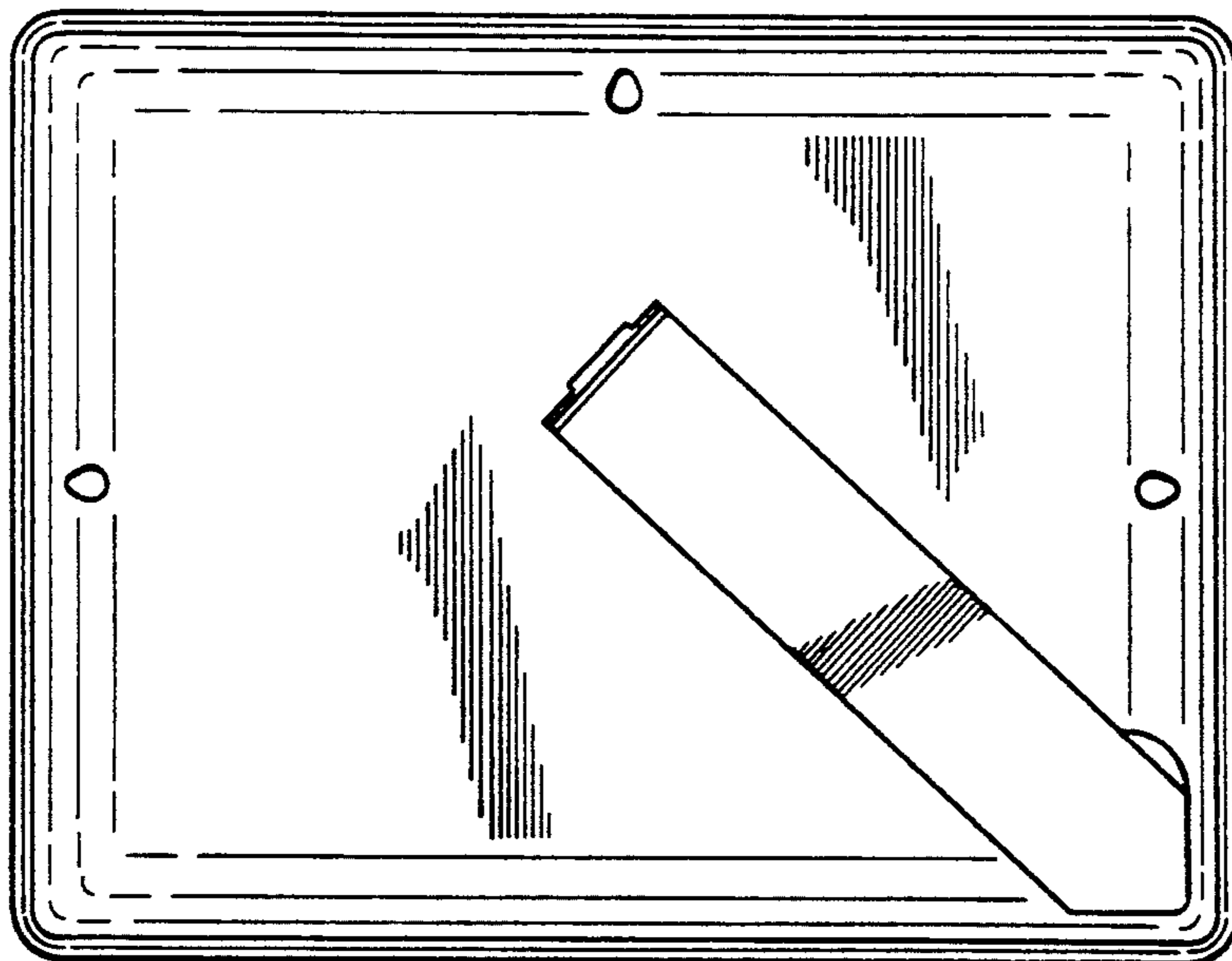

Fig. 70

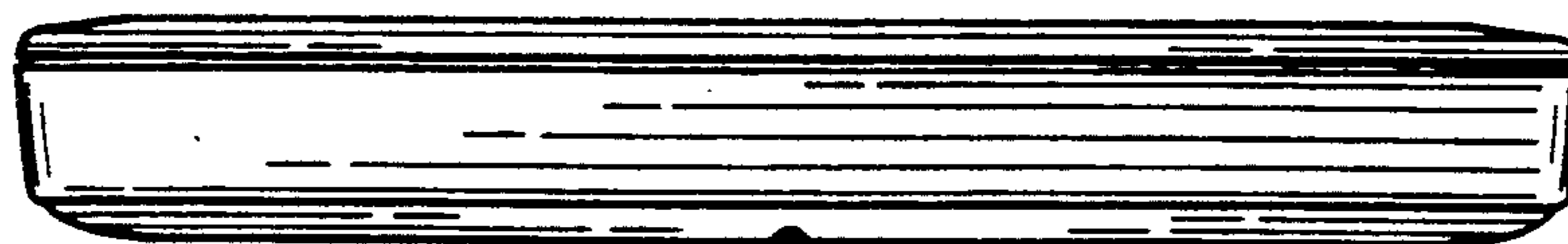

Fig. 72

Fig. 73

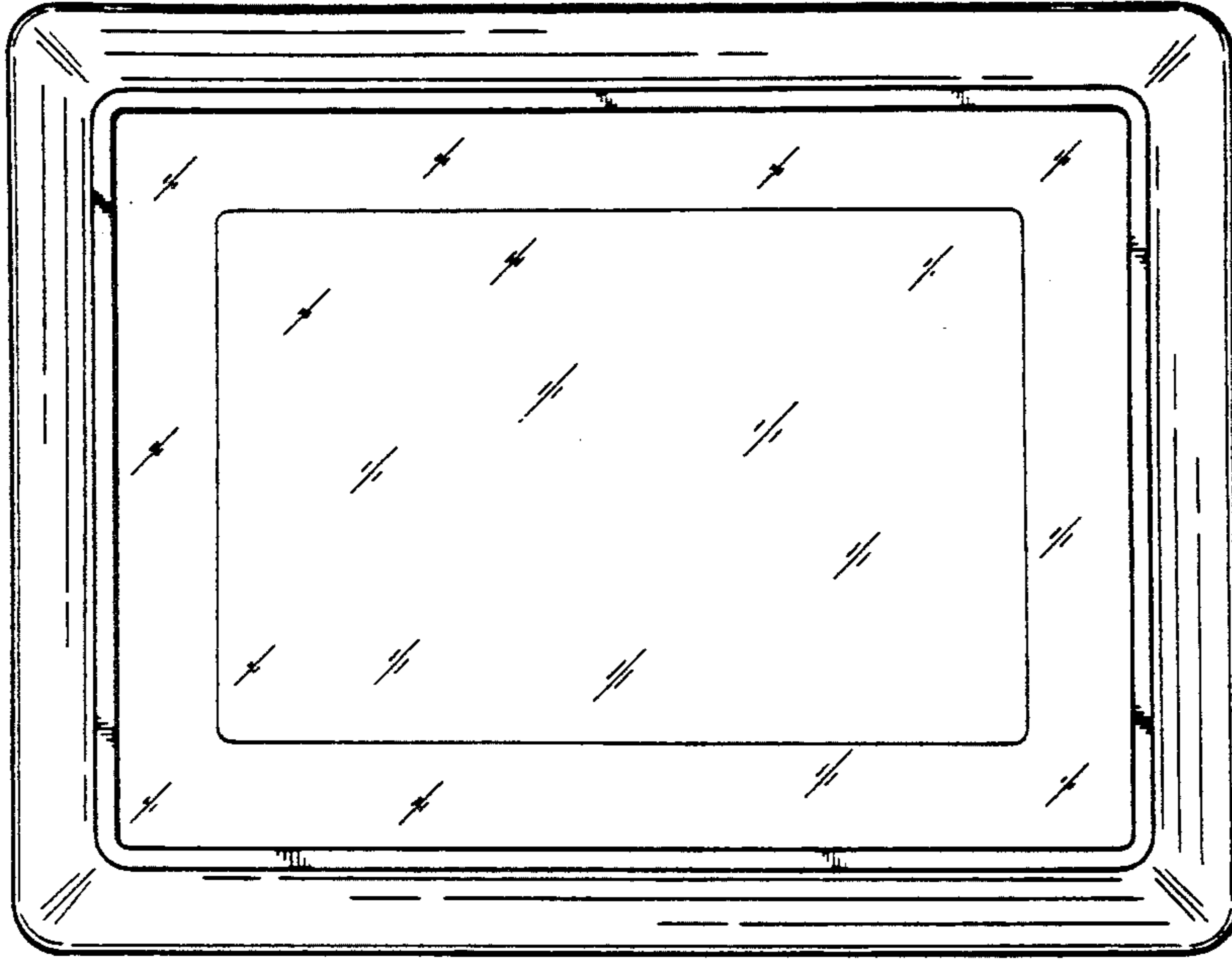

Fig. 74

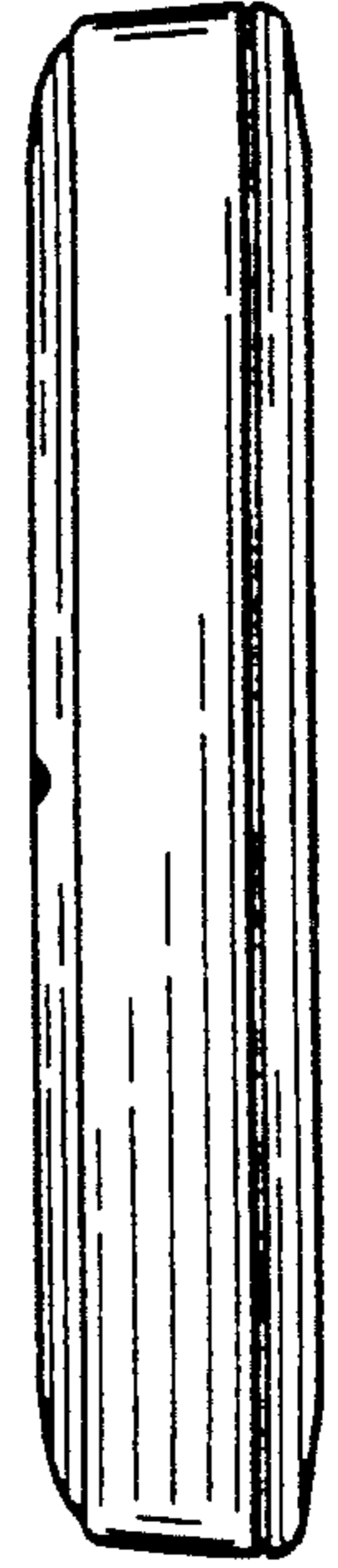

Fig. 75

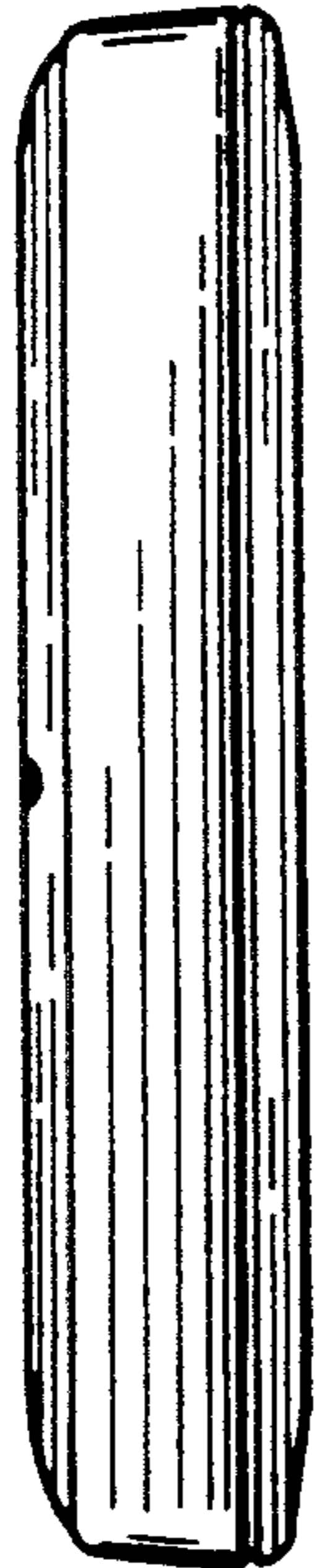
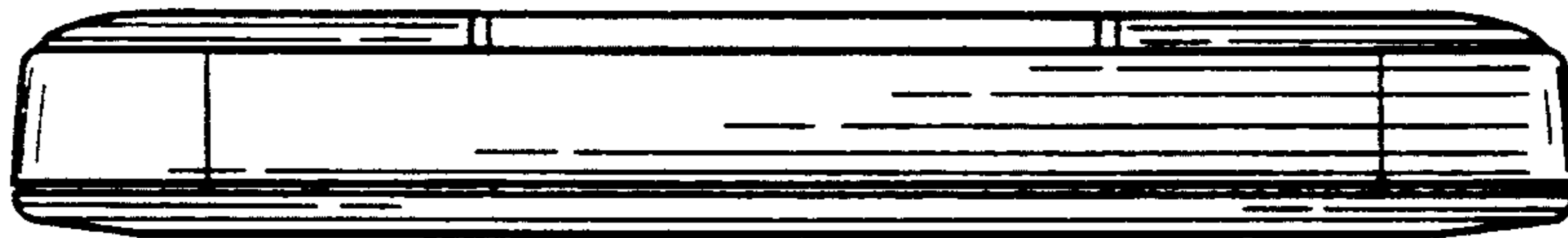

Fig. 77

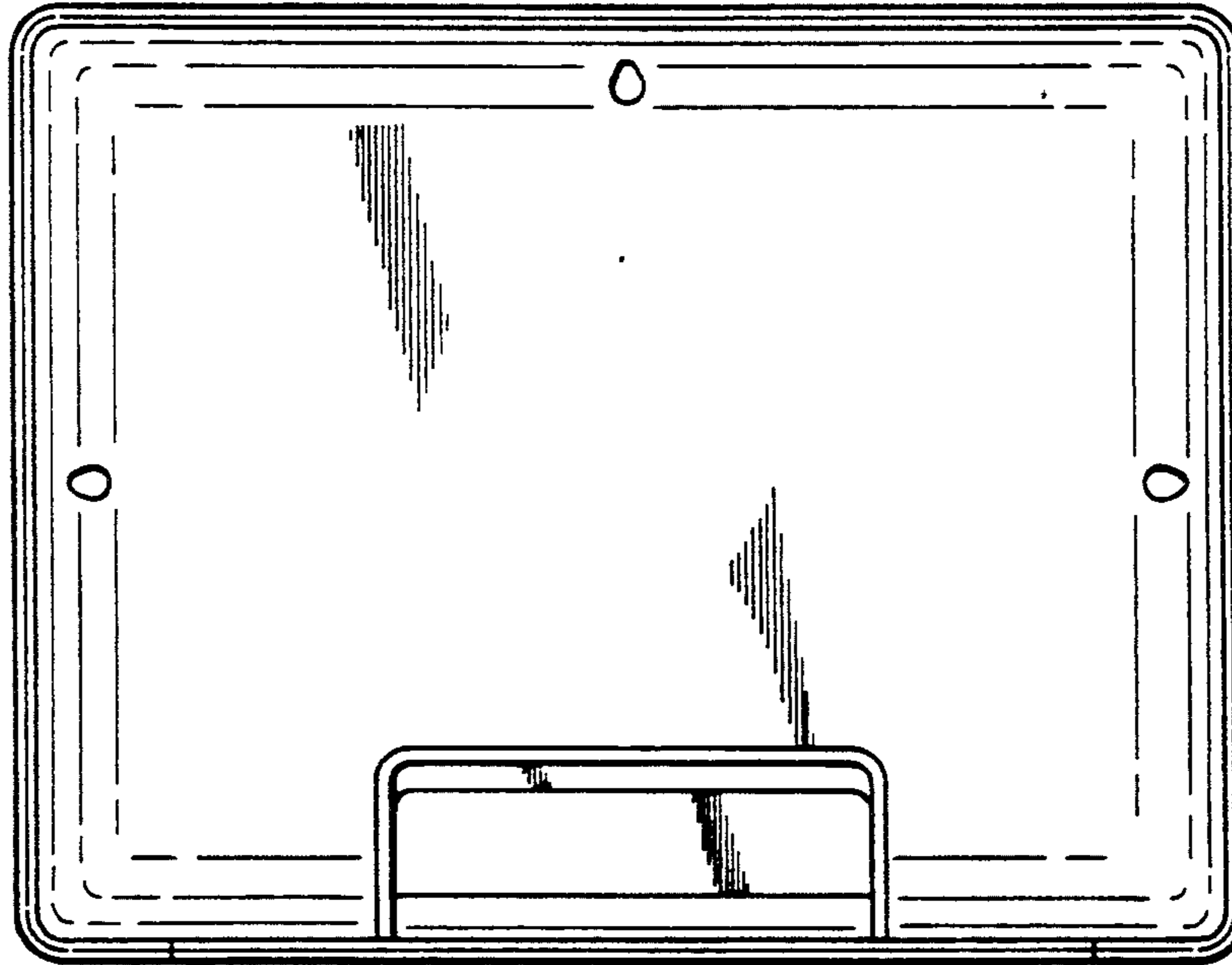

Fig. 76

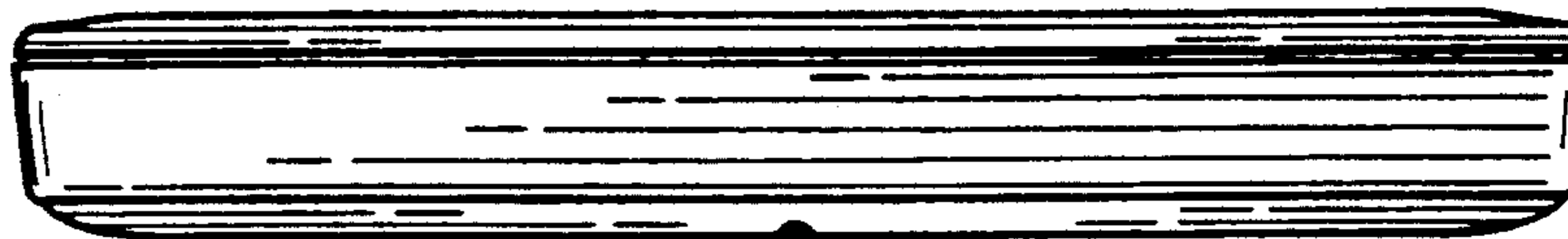

Fig. 78

Fig. 79

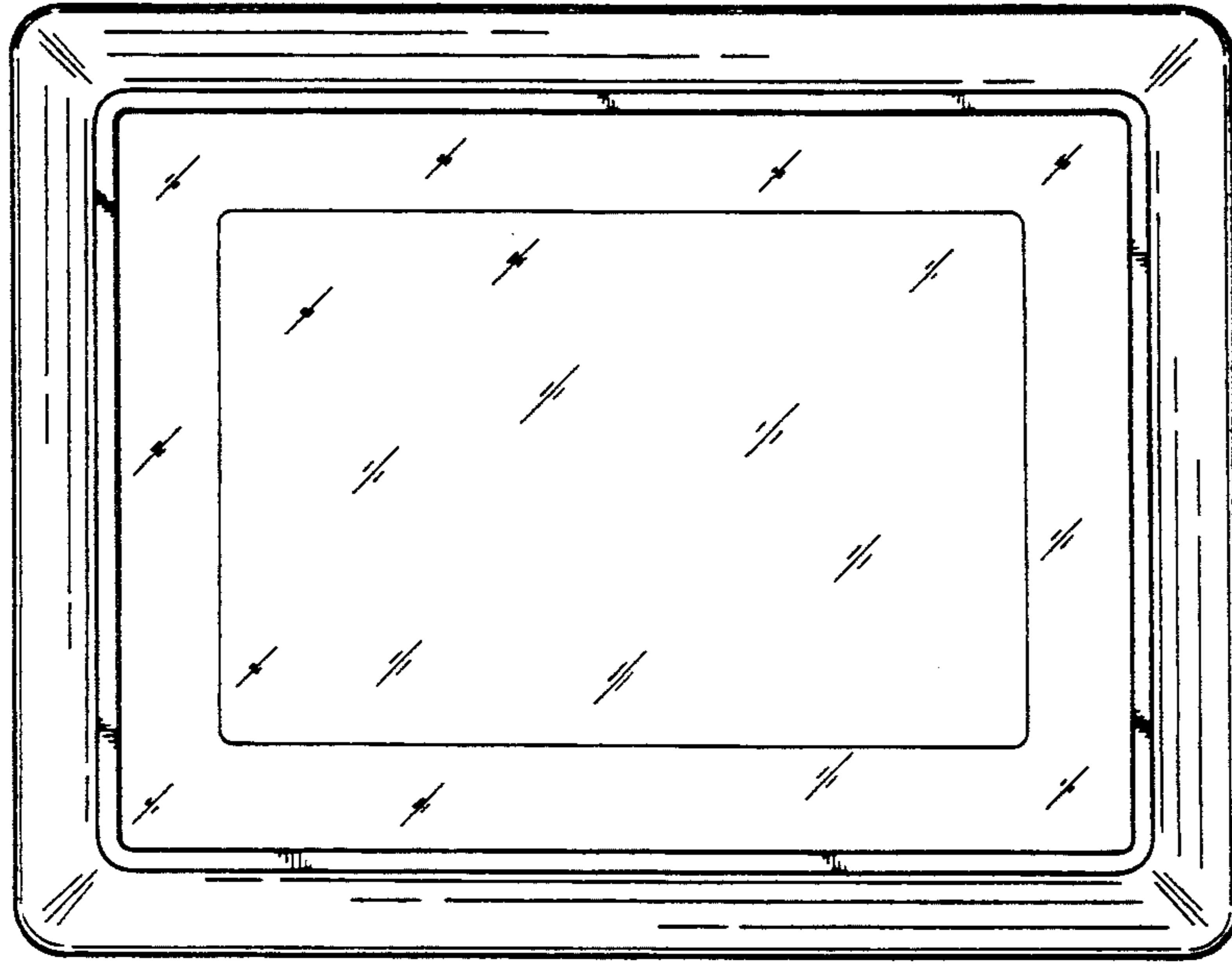

Fig. 80

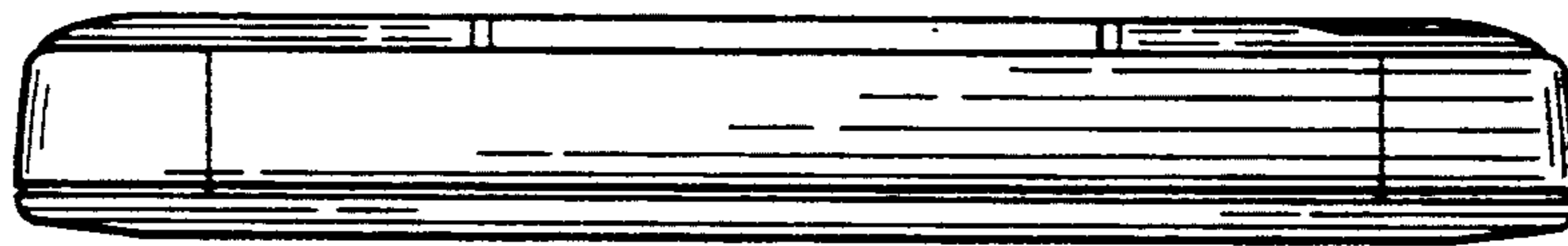

Fig. 81

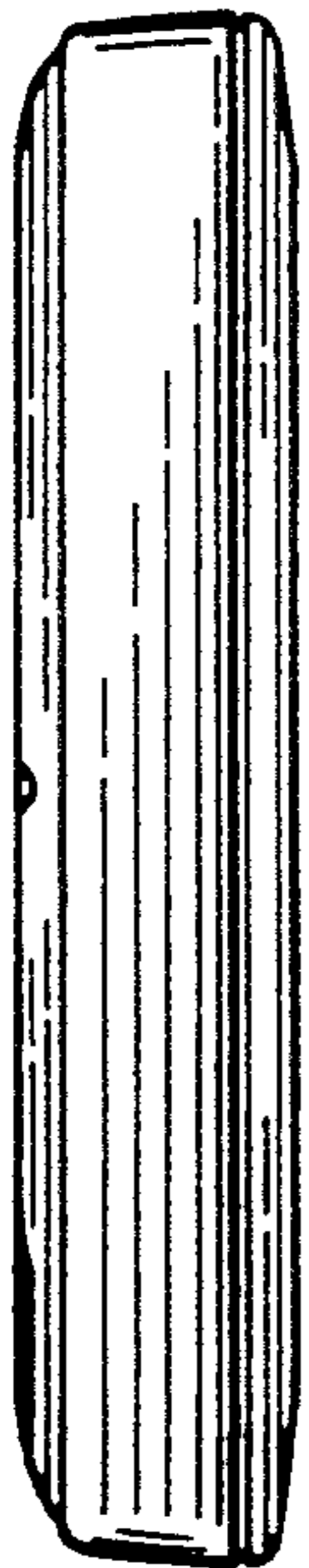

Fig. 83

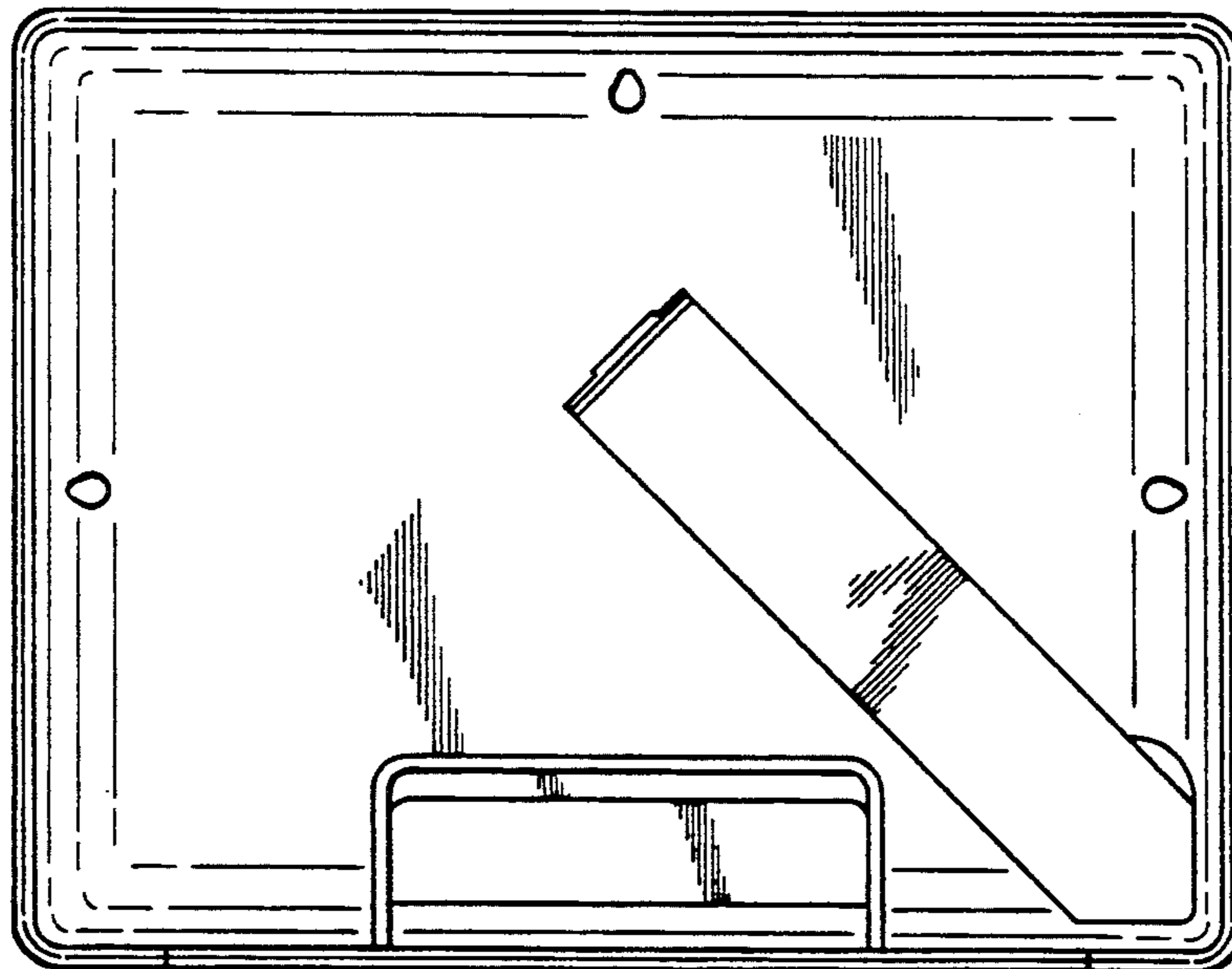

Fig. 82

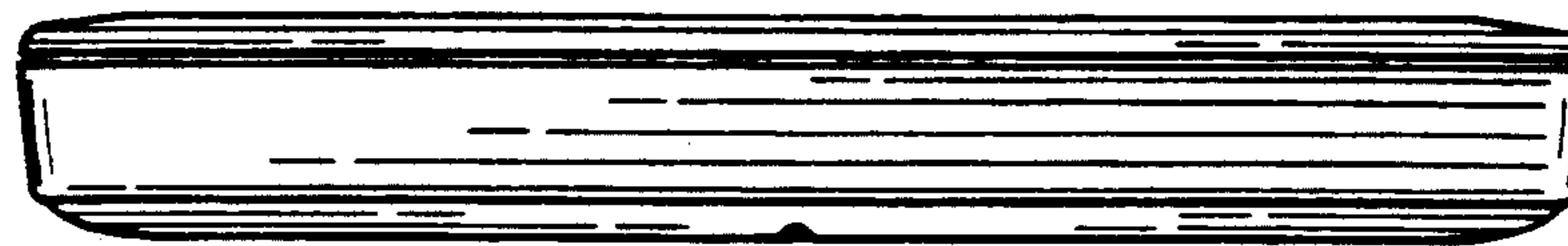

Fig. 84

Fig. 85

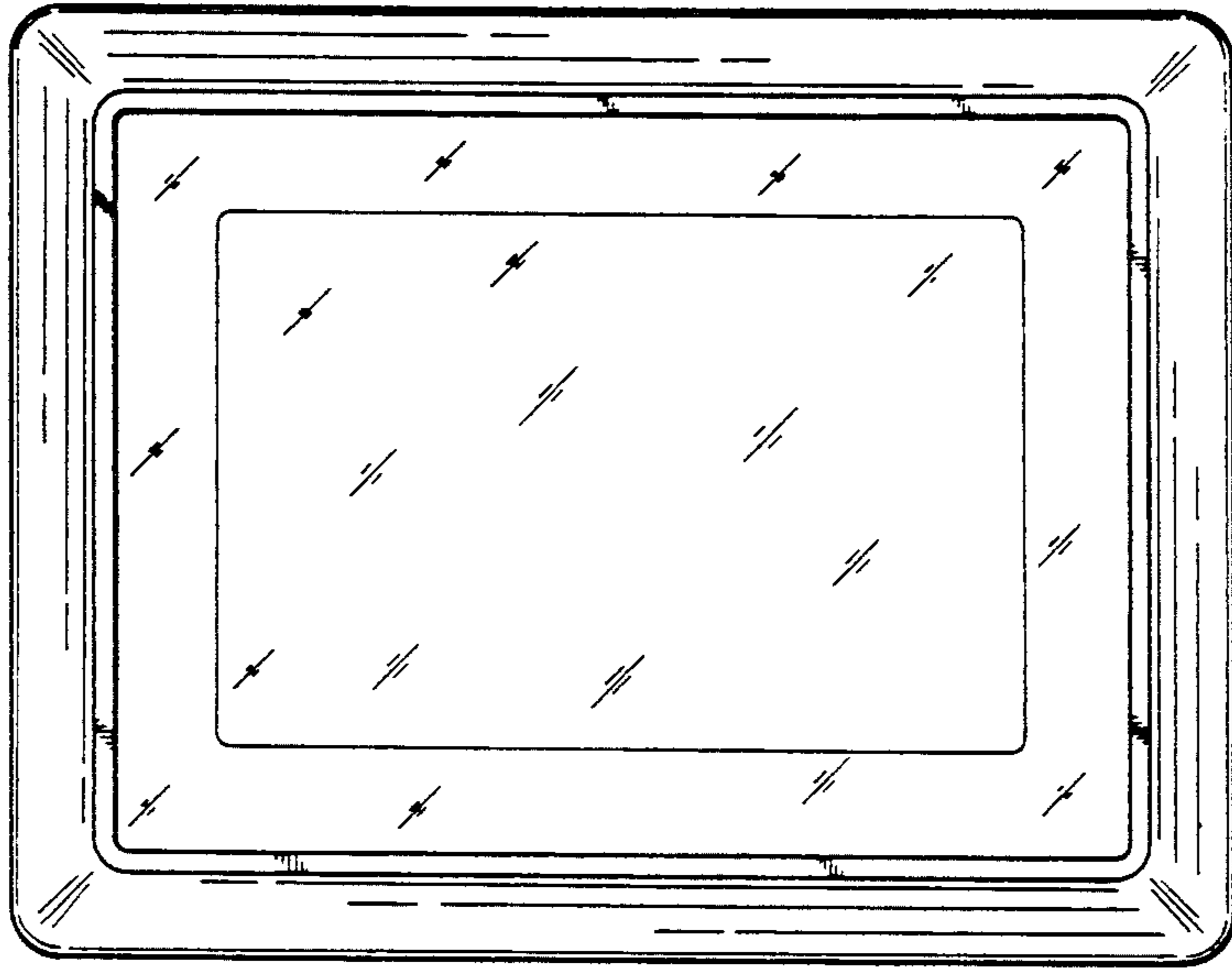

Fig. 86

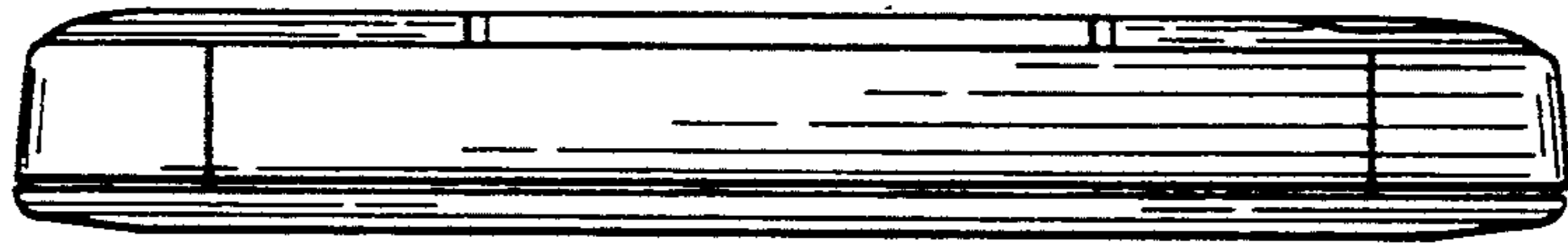

Fig. 87



Fig. 89

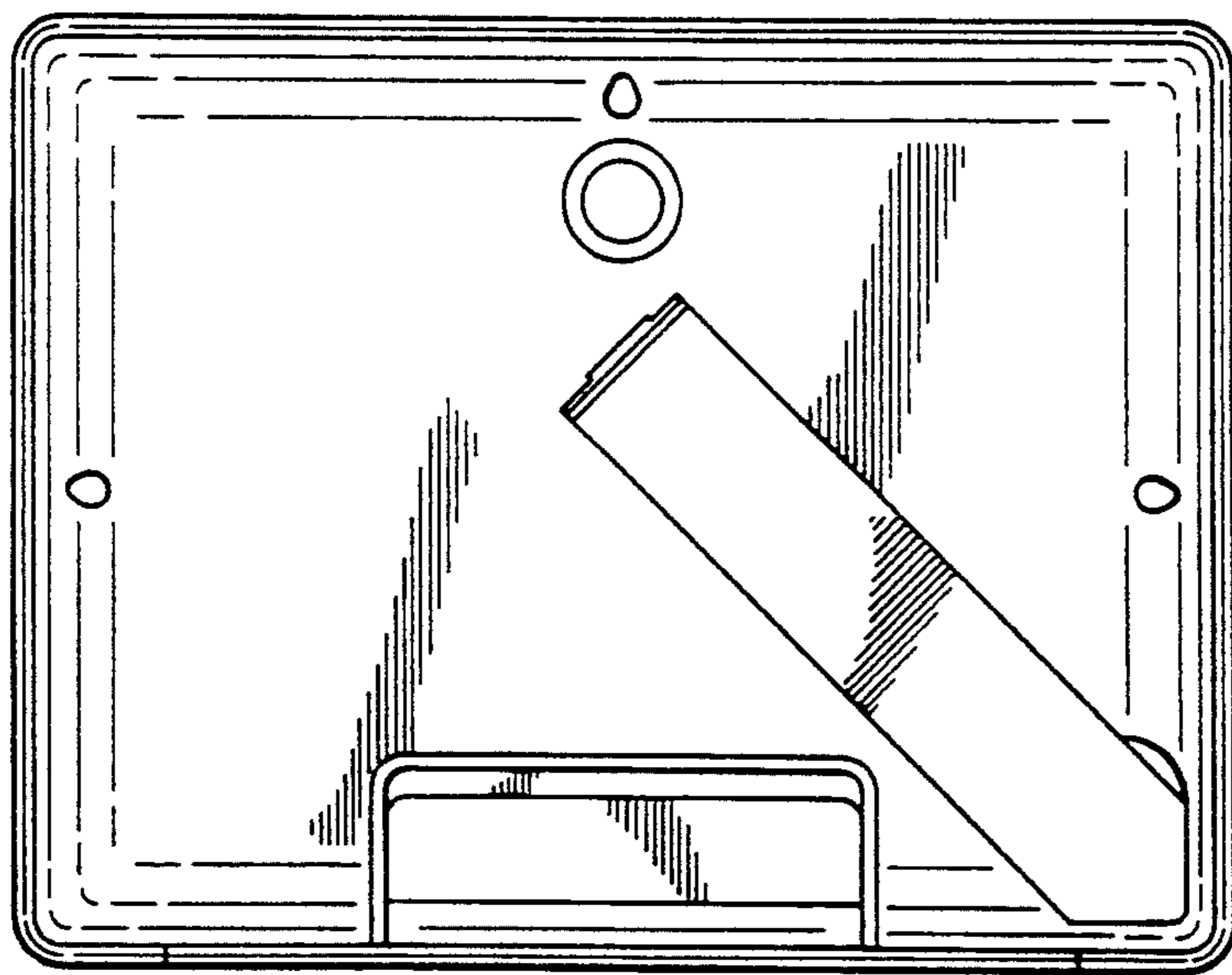

Fig. 88

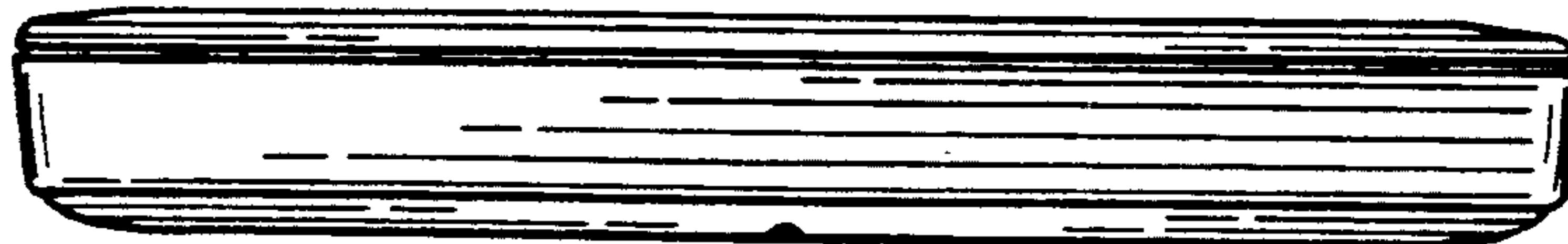

Fig. 90

Fig. 91

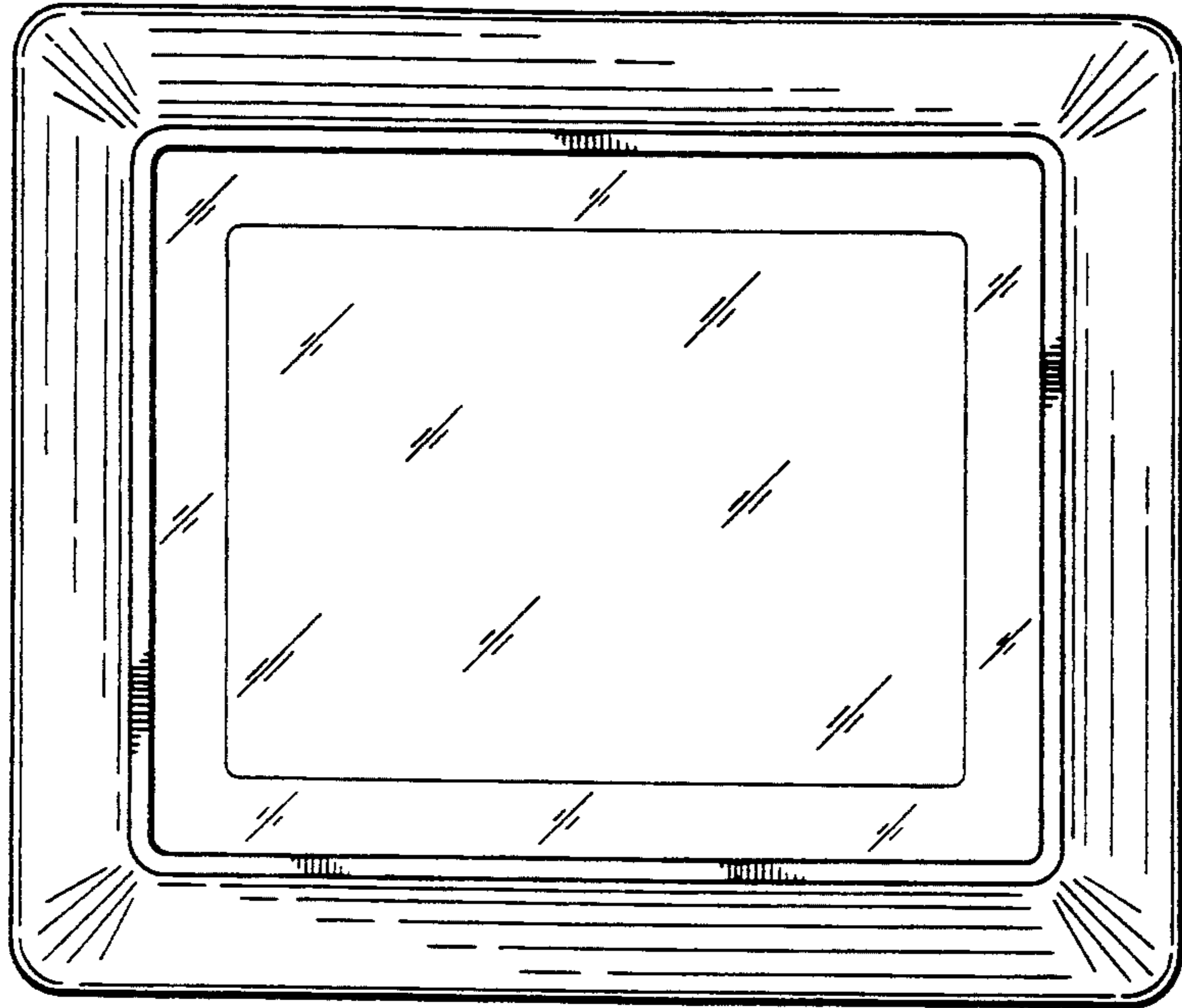

Fig. 92

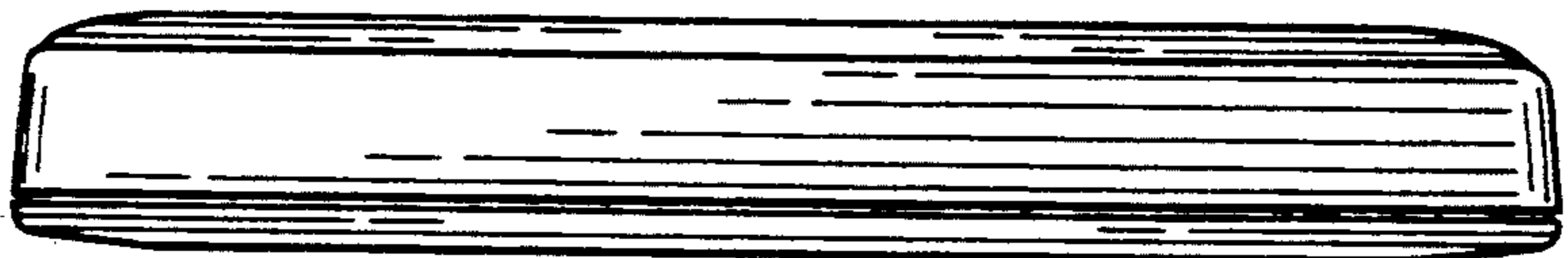
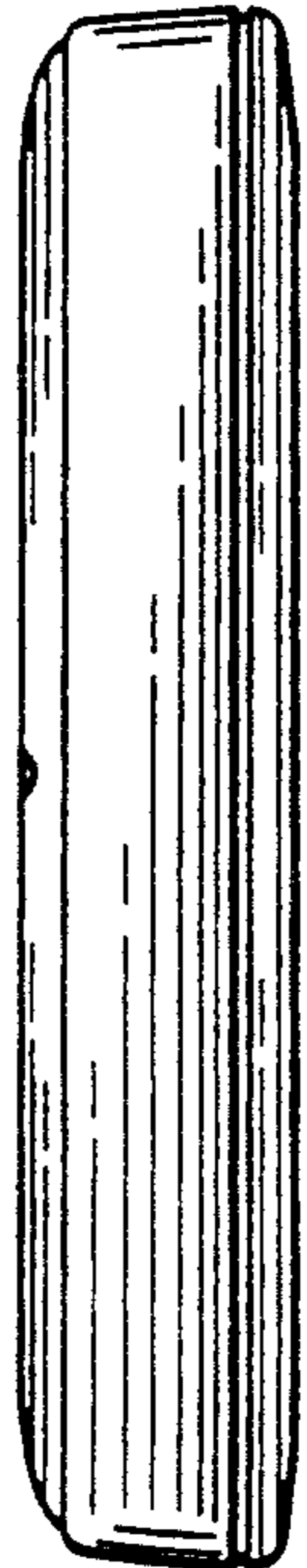

Fig. 93



Fig. 95

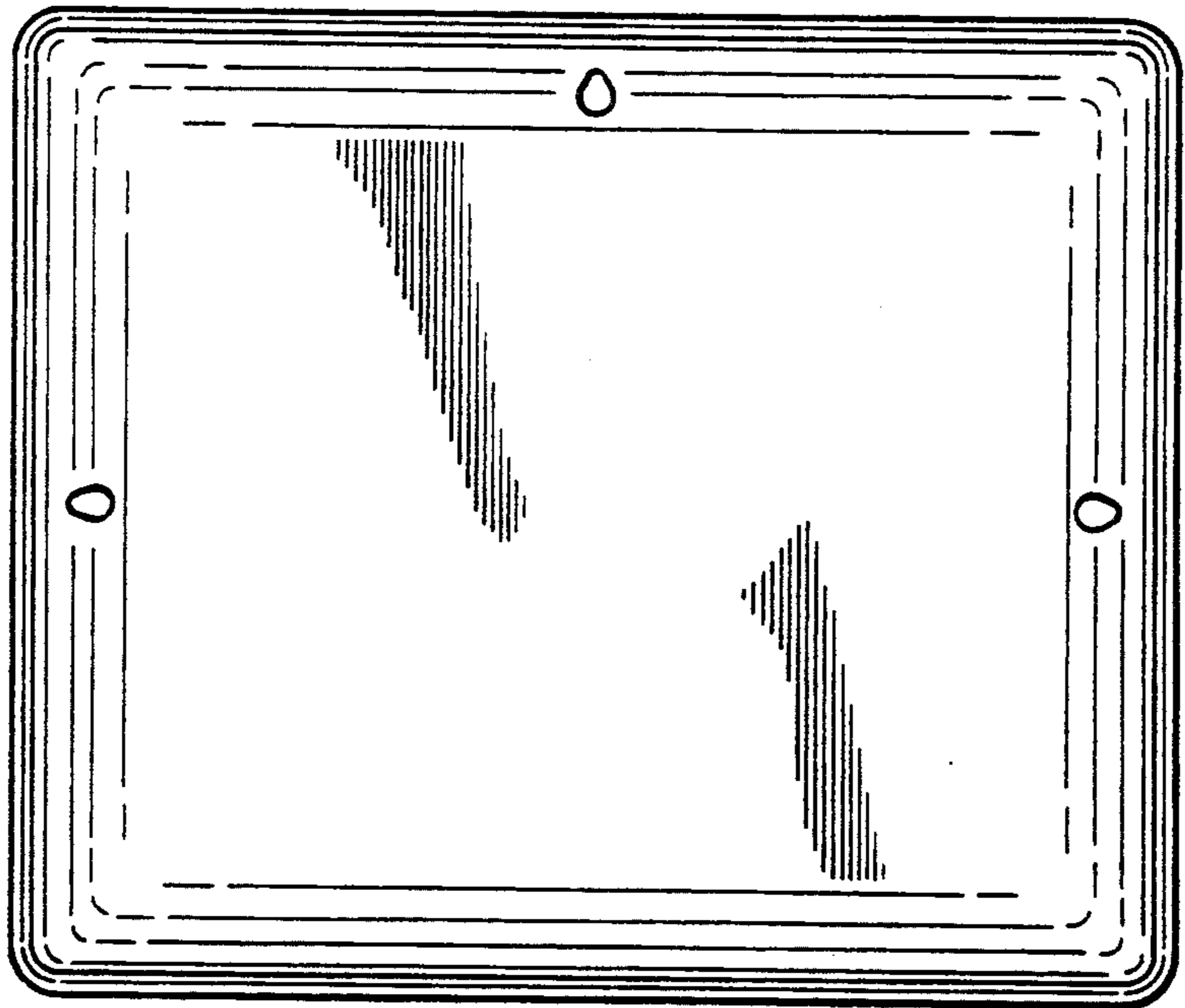

Fig. 94

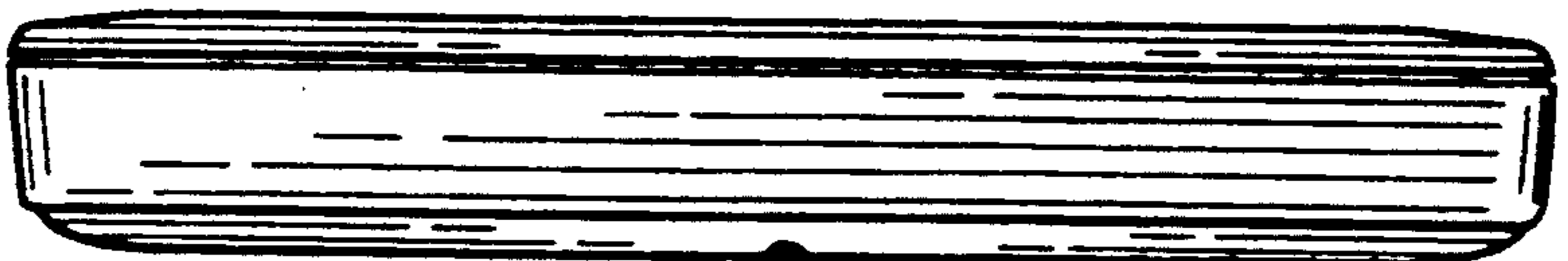

Fig. 96

Fig. 97

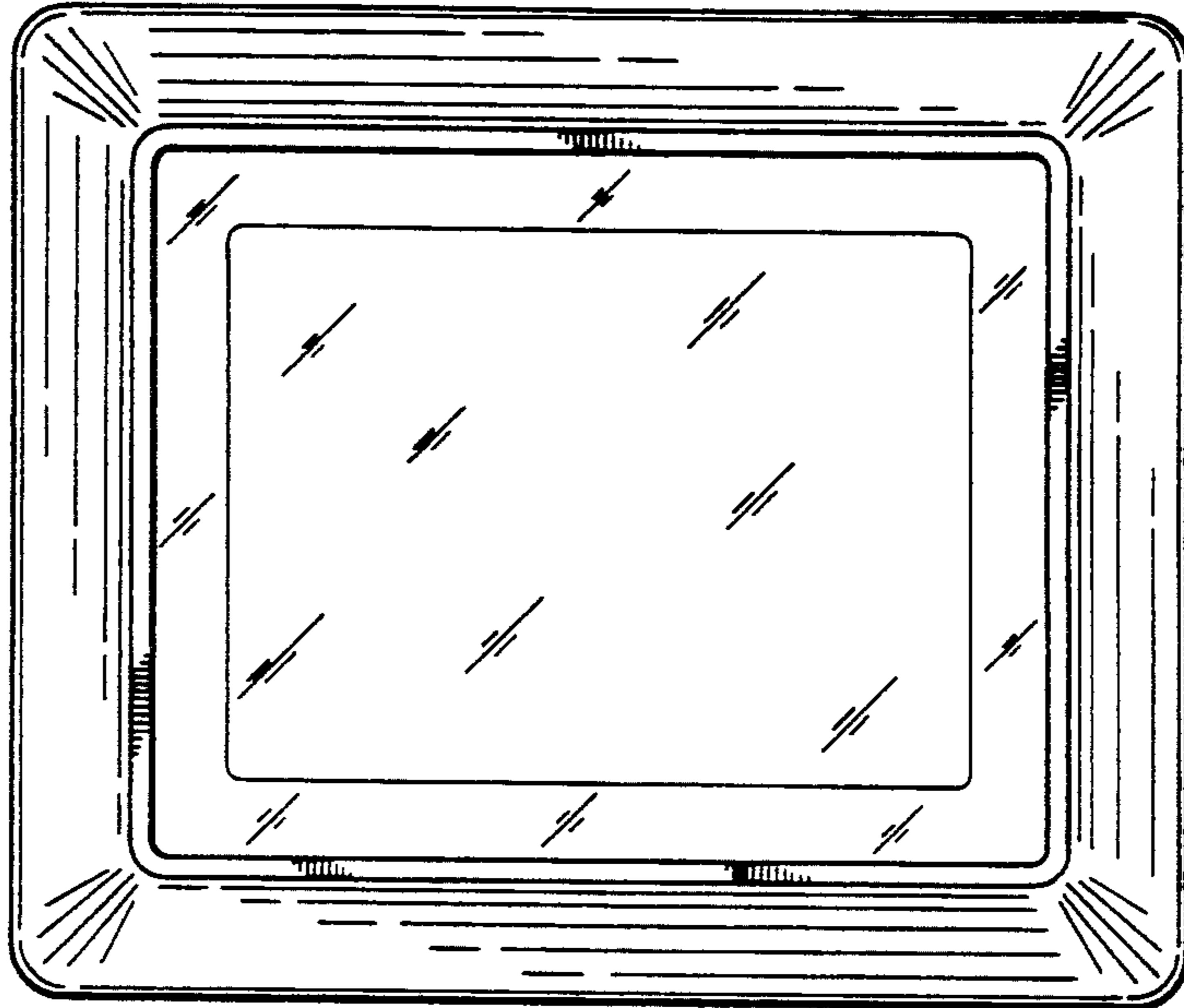

Fig. 98

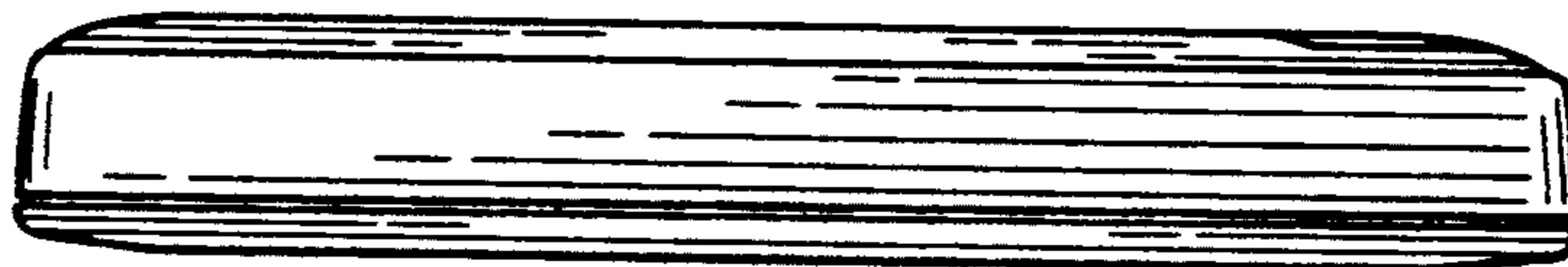
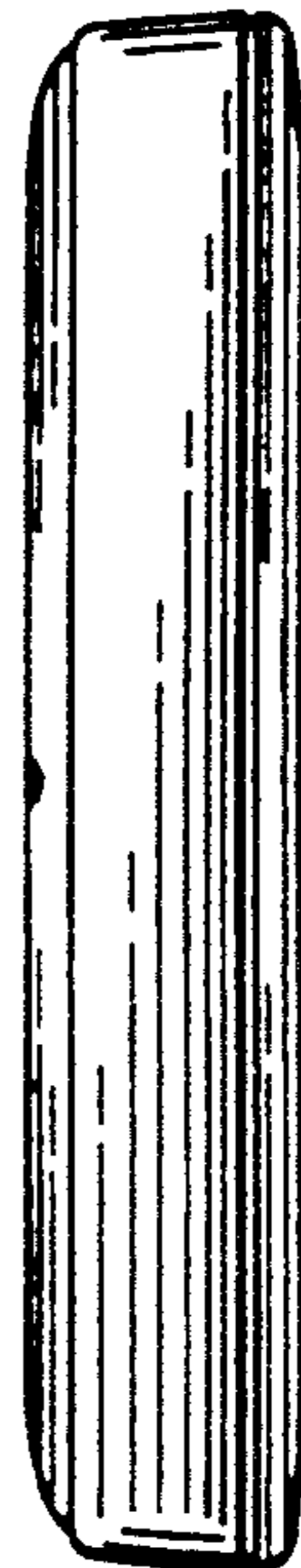

Fig. 99



Fig. 101

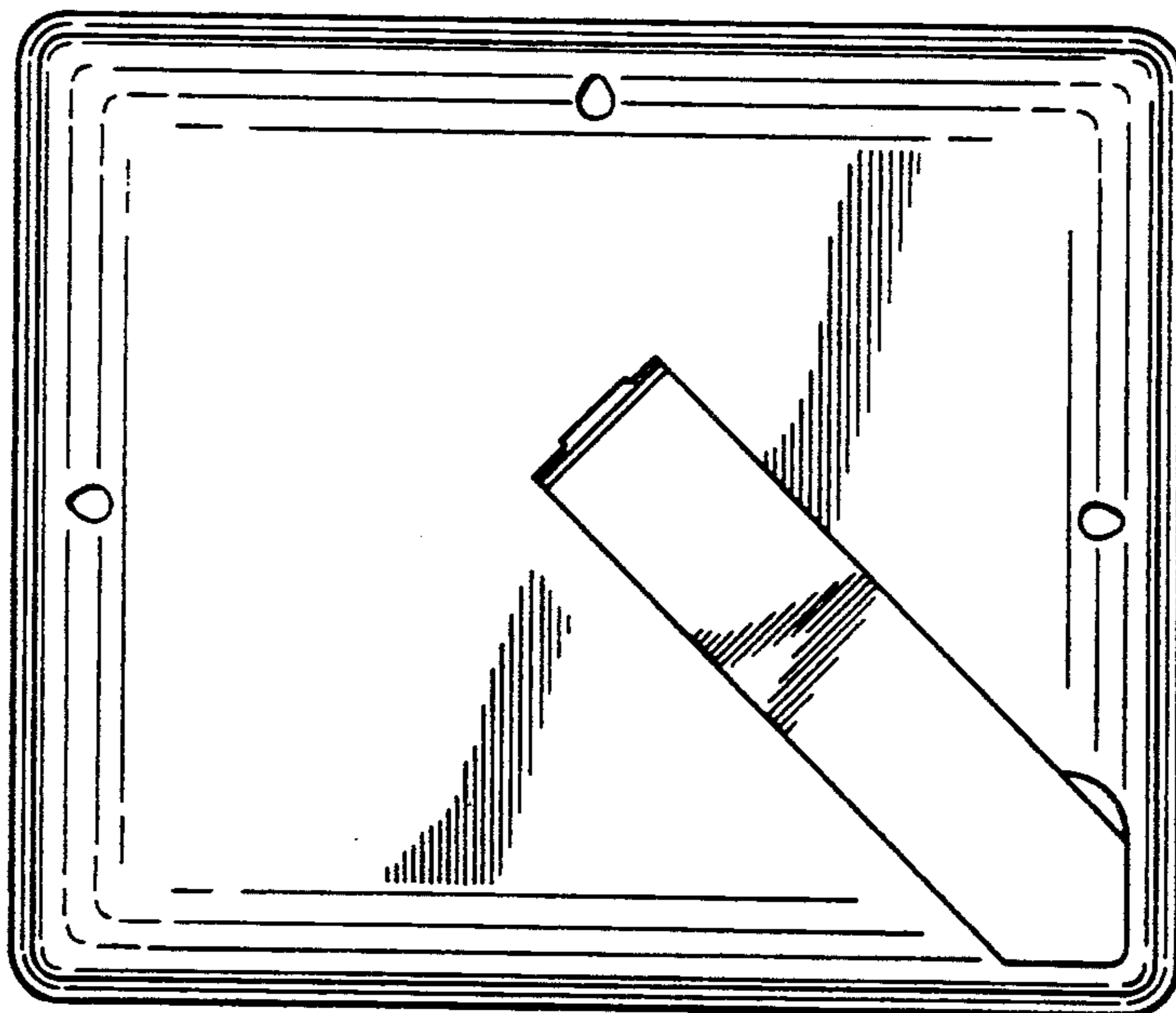

Fig. 100

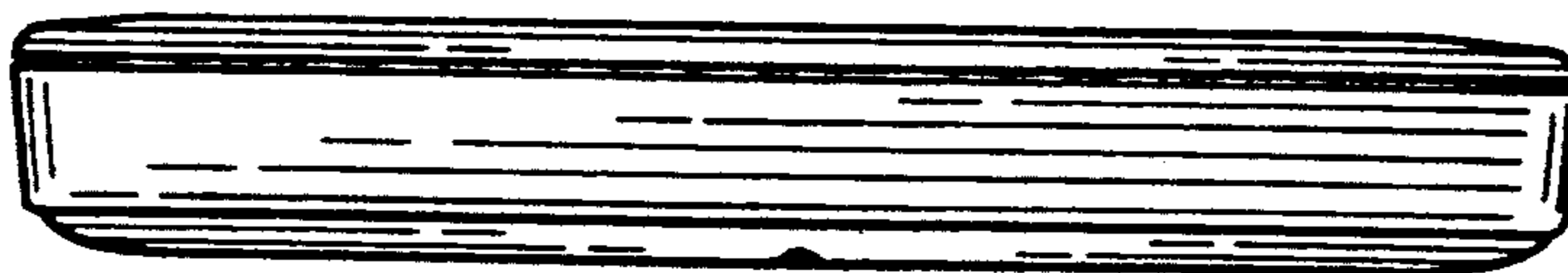

Fig. 102

Fig. 103

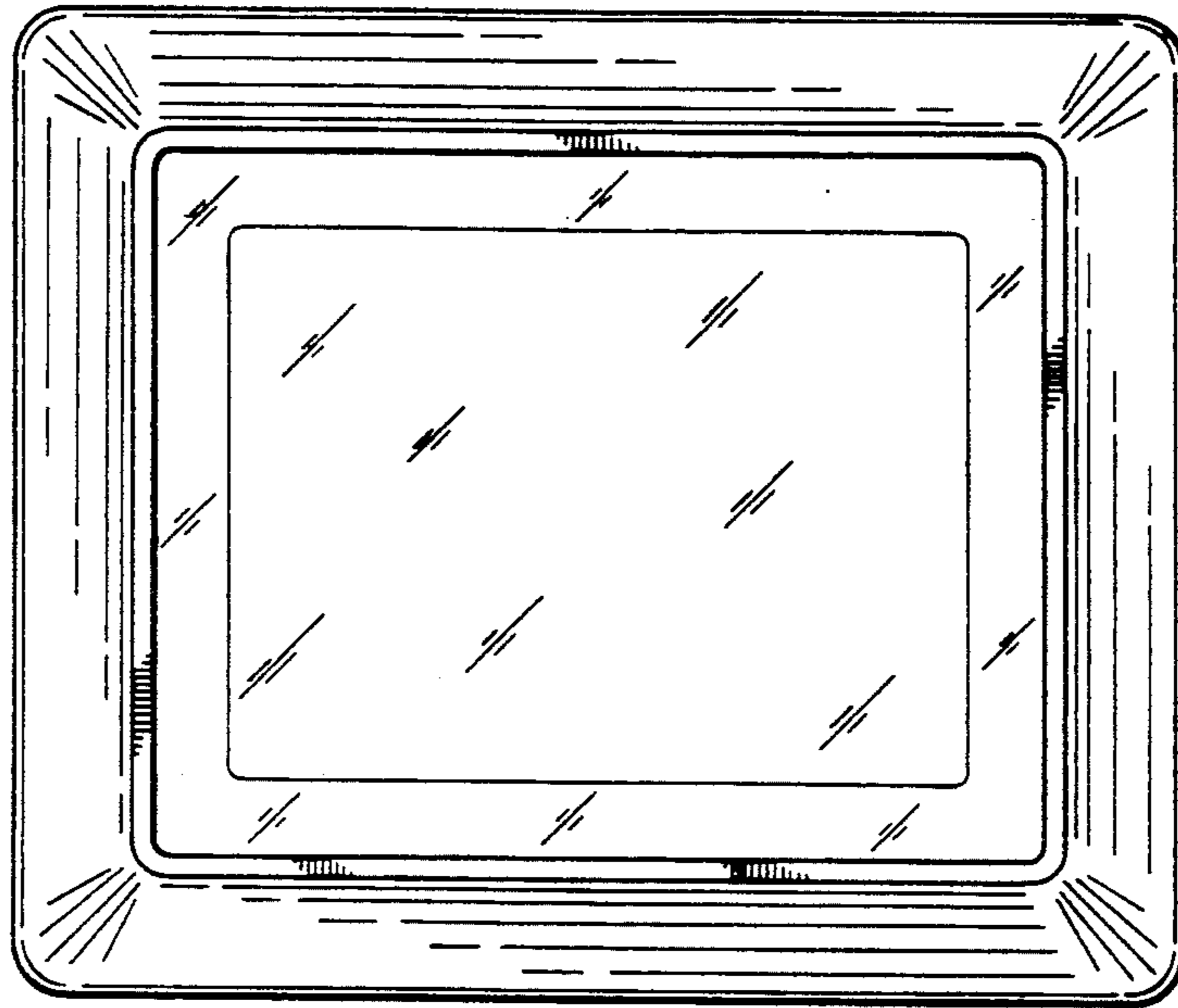

Fig. 104

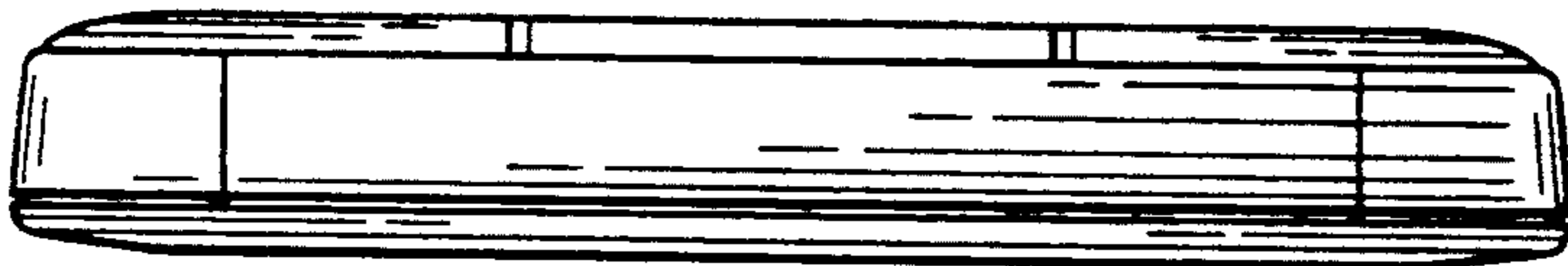
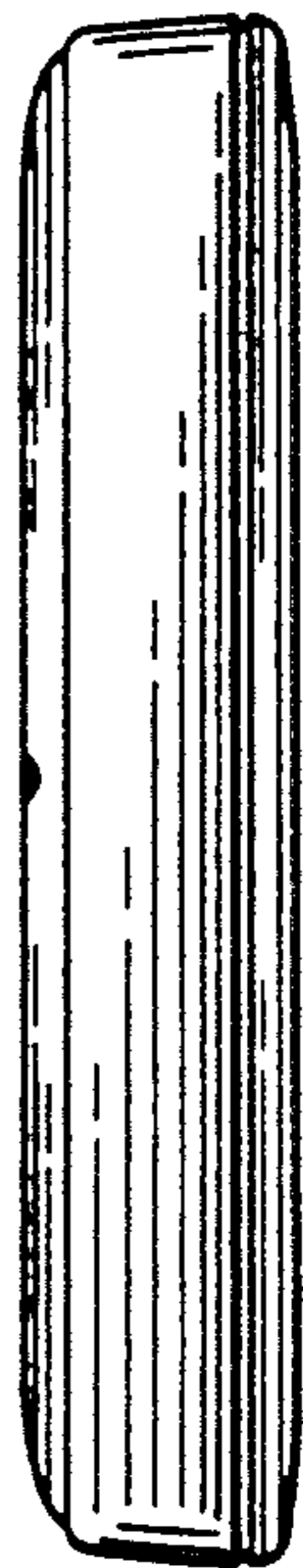

Fig. 105



Fig. 107

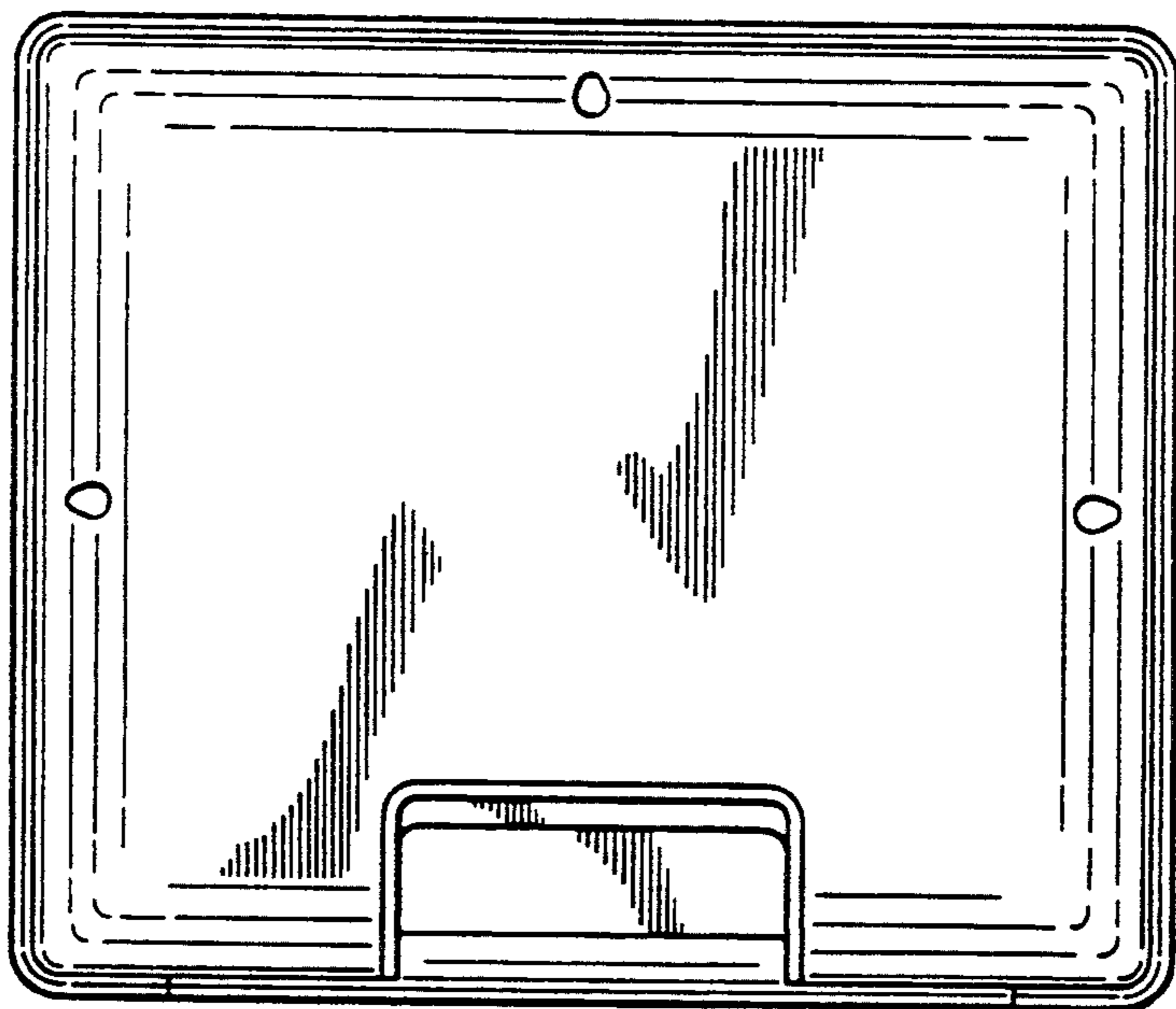

Fig. 106

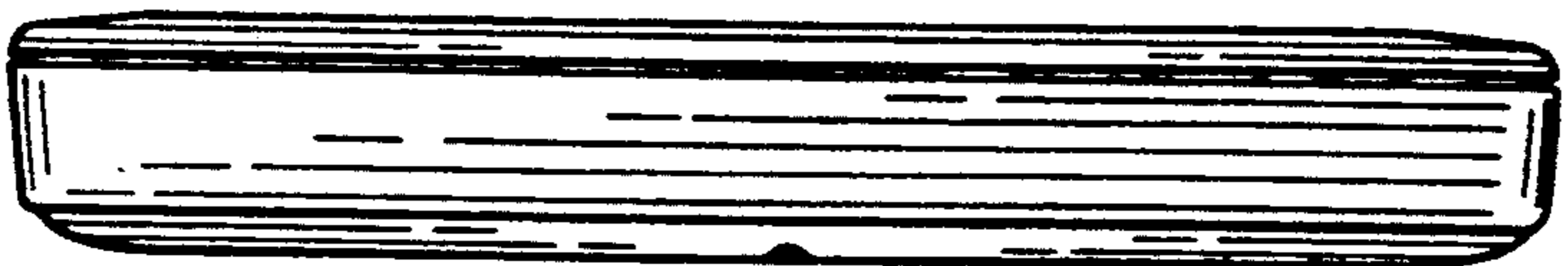

Fig. 108

Fig. 109

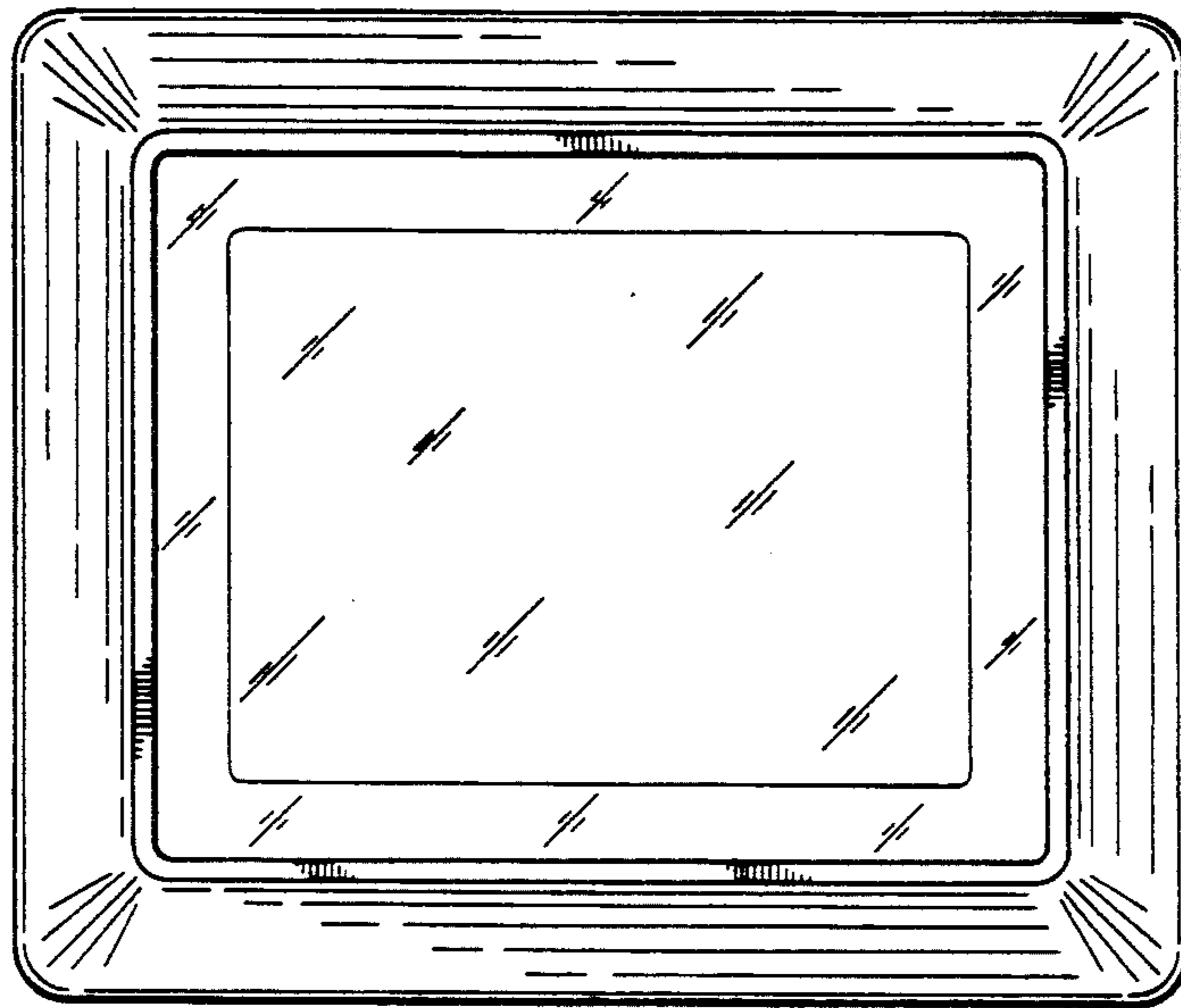

Fig. 110

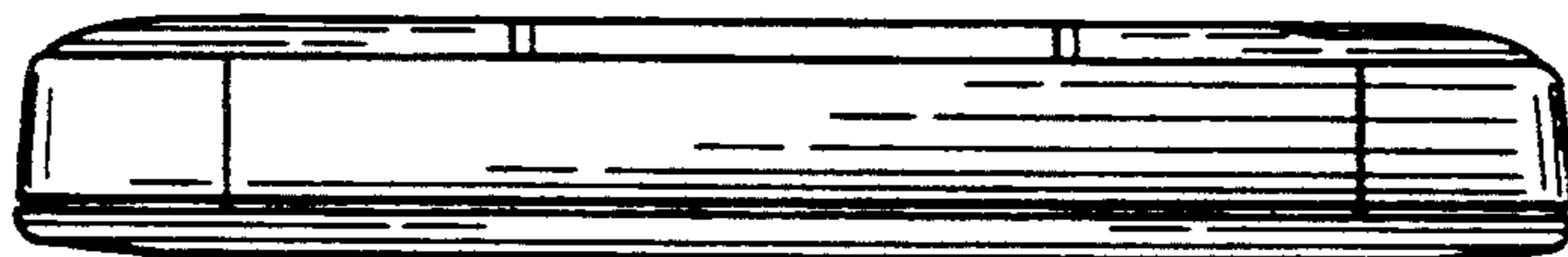

Fig. 111



Fig. 113

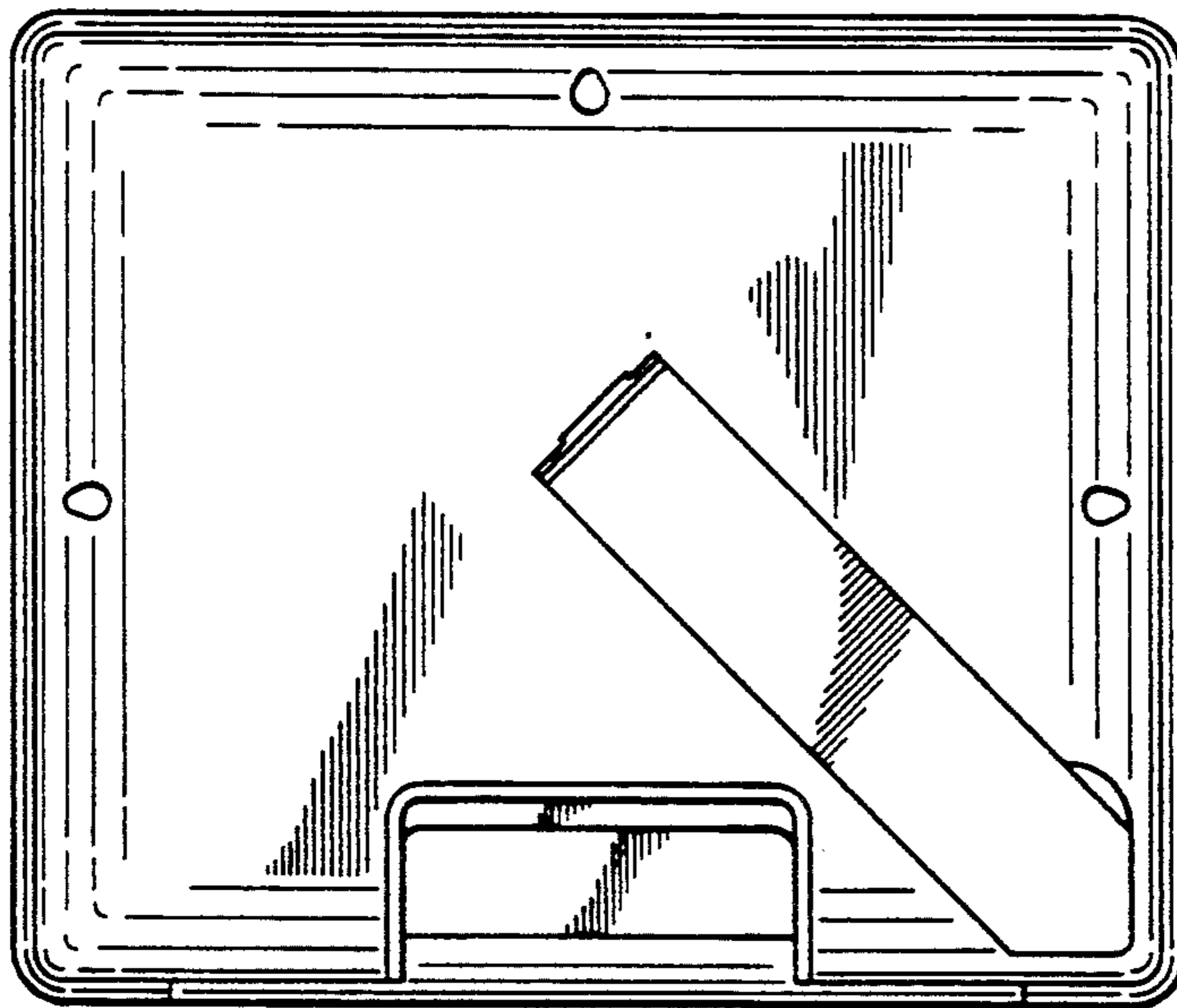

Fig. 112

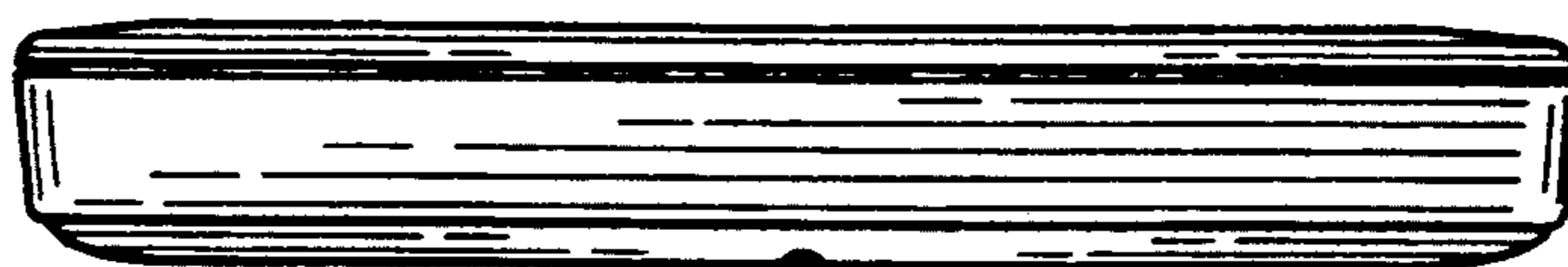

Fig. 114

Fig. 115

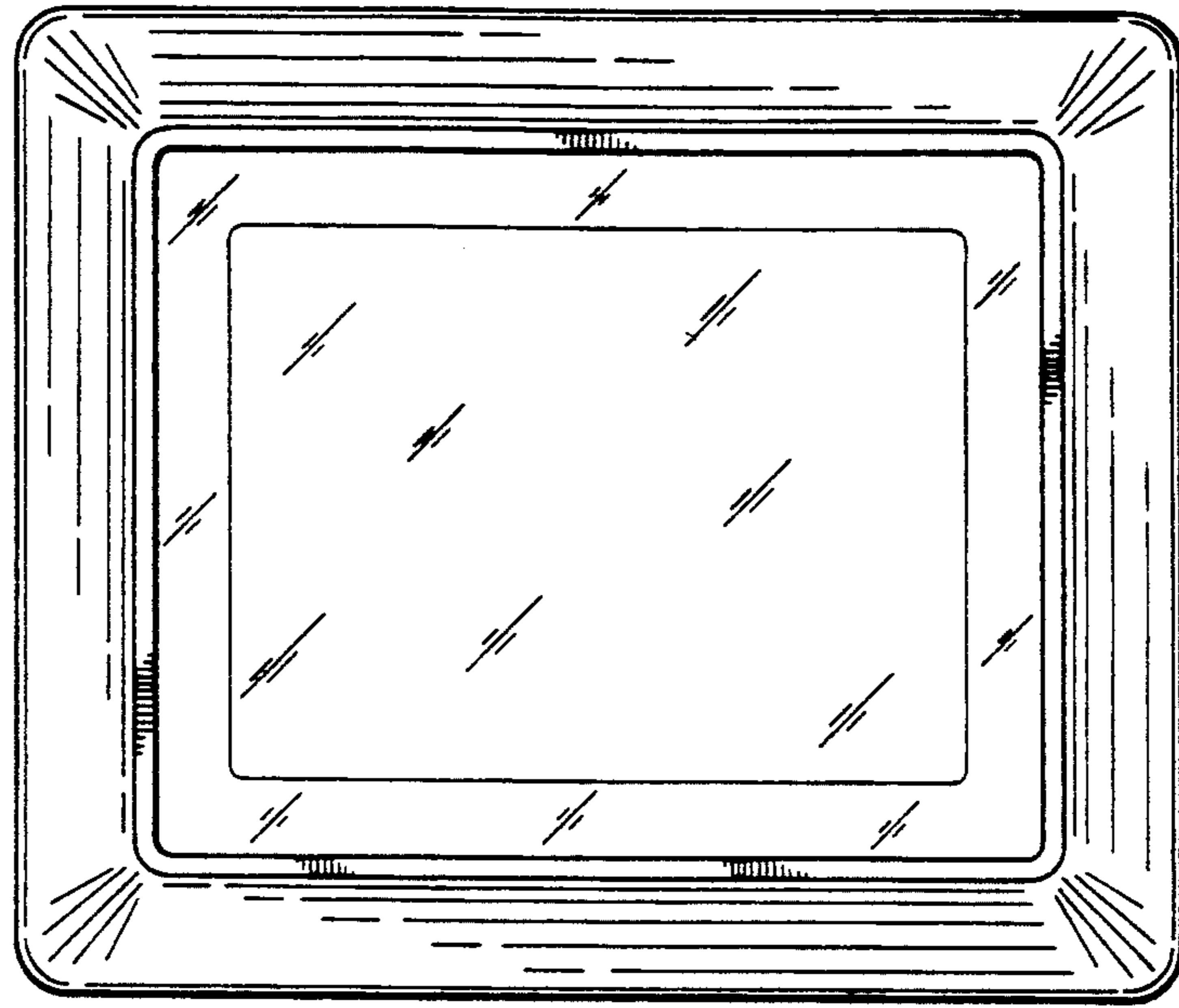

Fig. 116

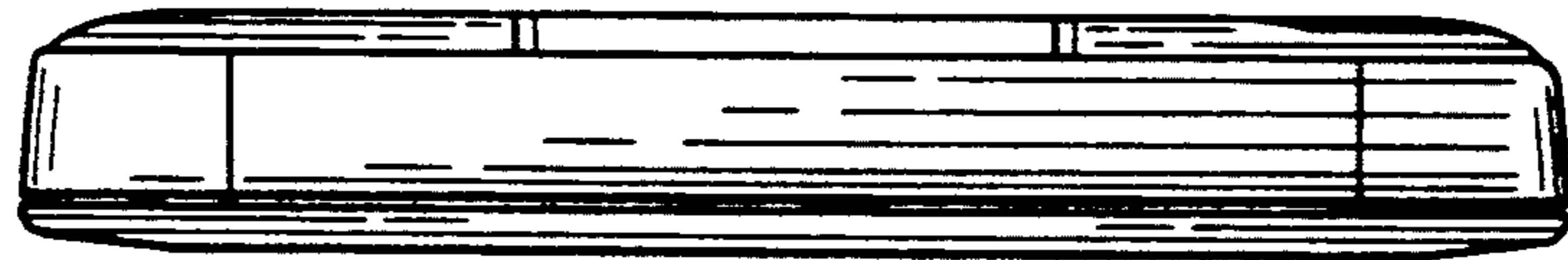
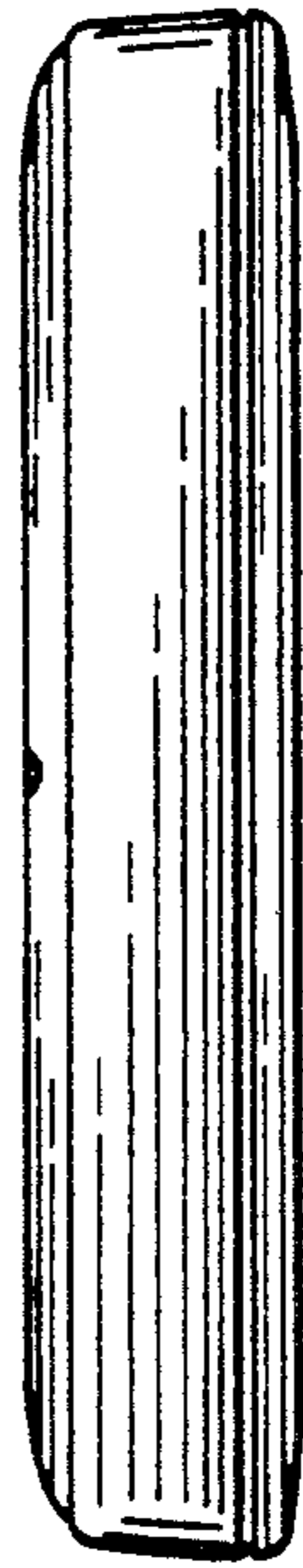

Fig. 117



Fig. 119

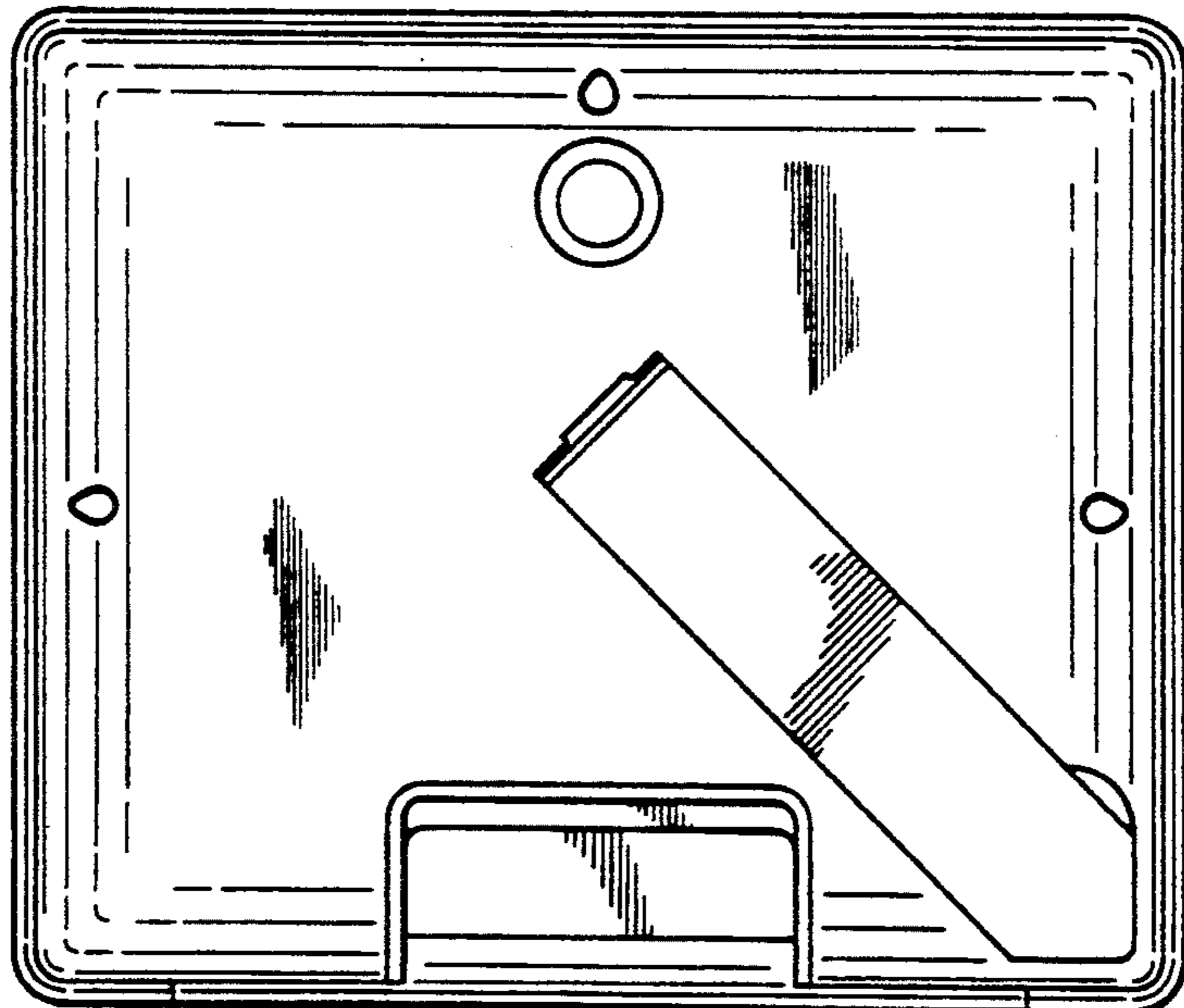

Fig. 118

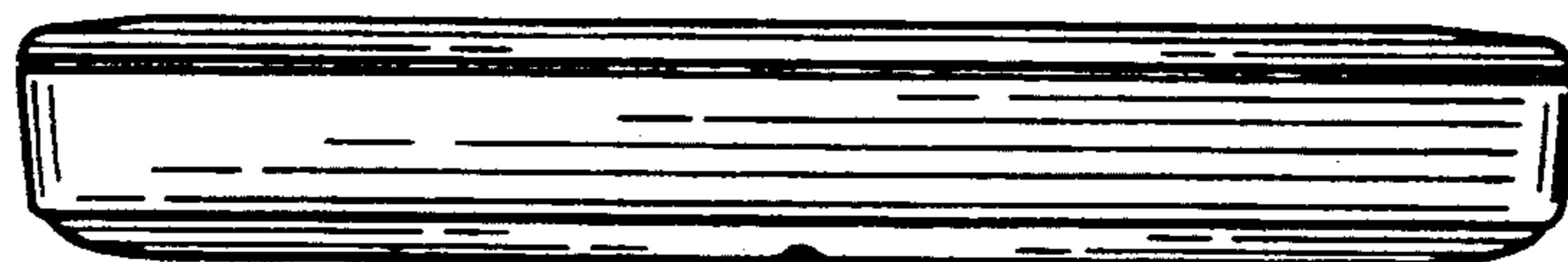

Fig. 120

Fig. 121

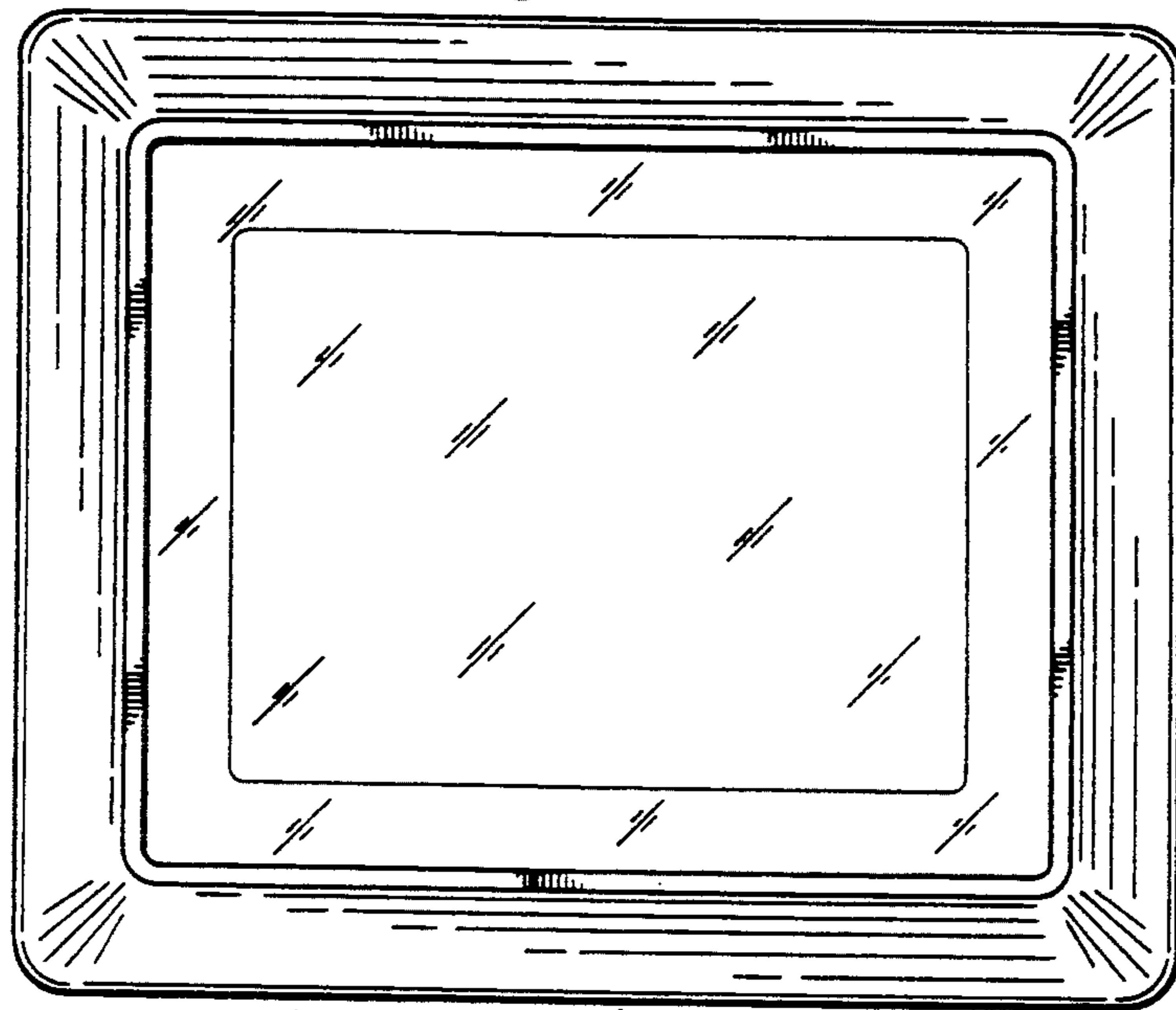

Fig. 122

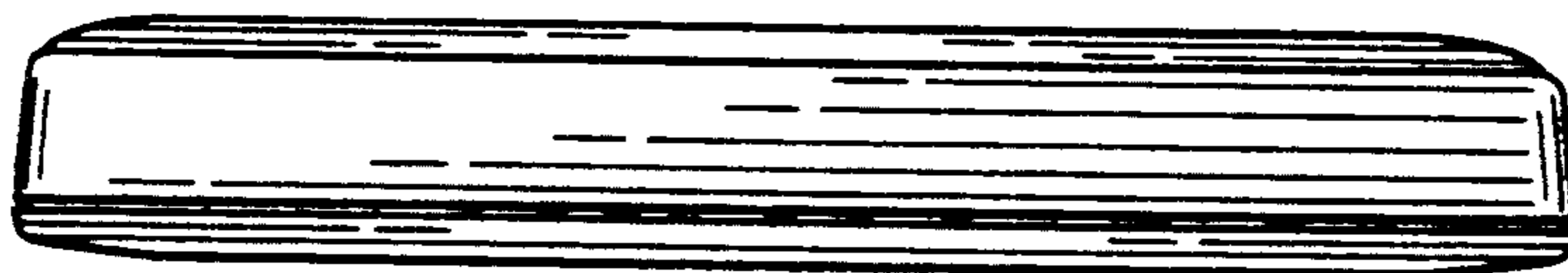
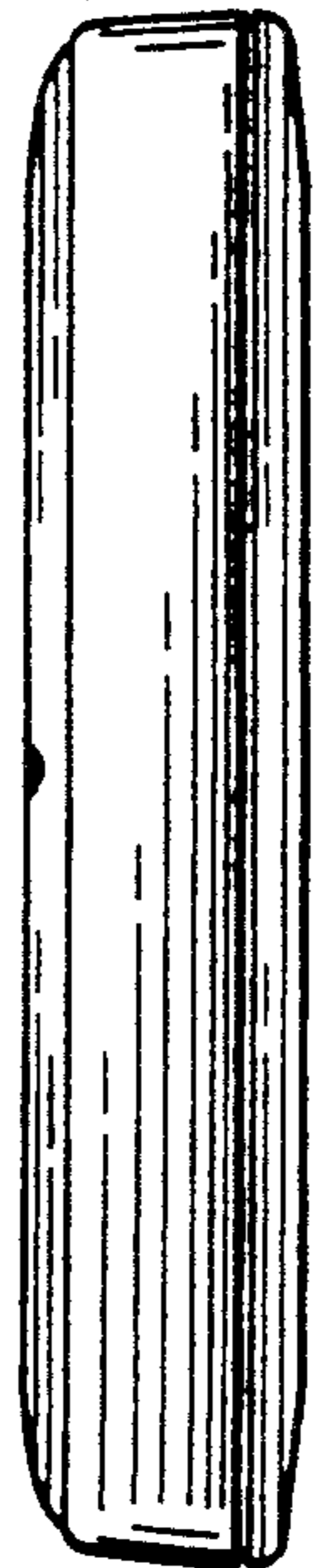

Fig. 123



Fig. 125

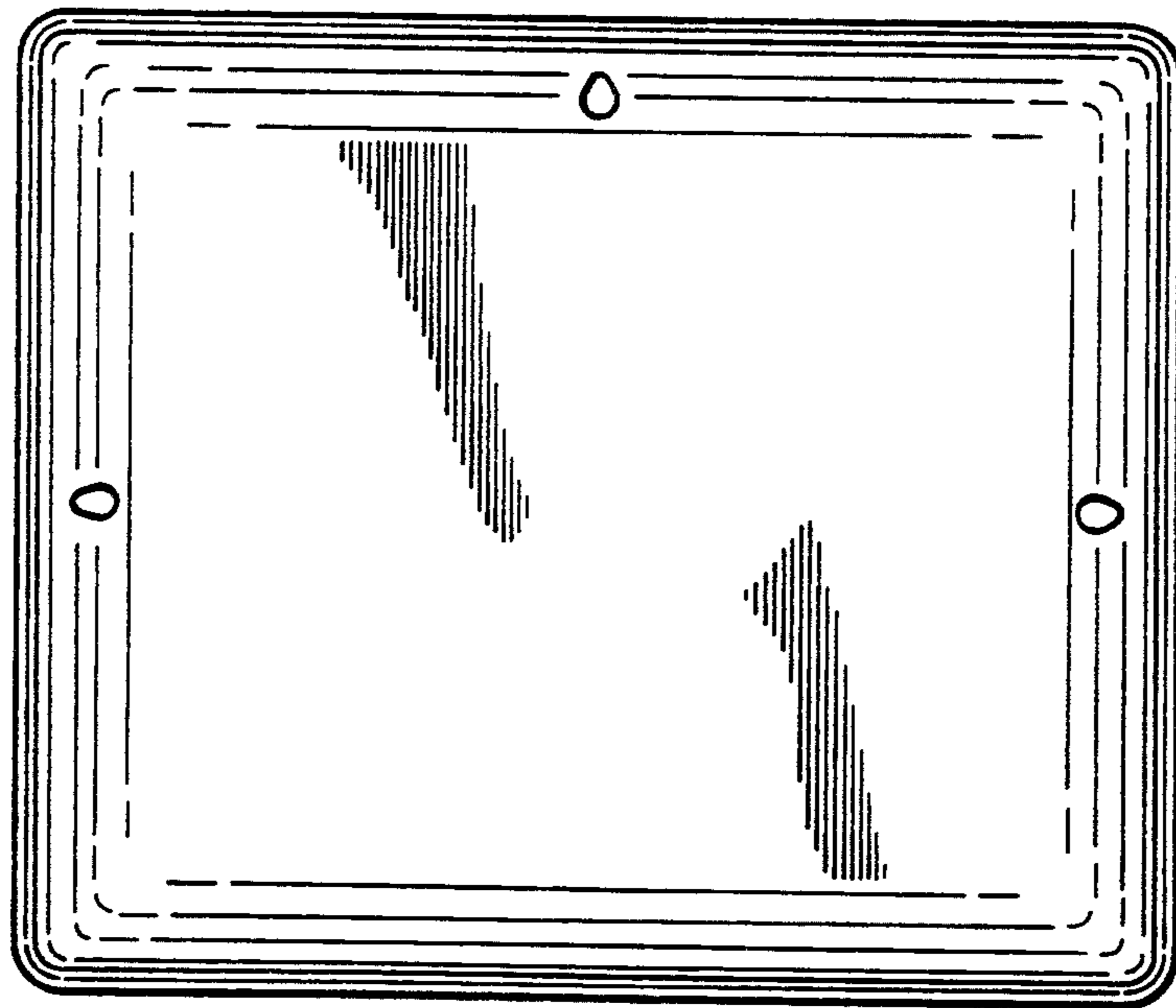

Fig. 124

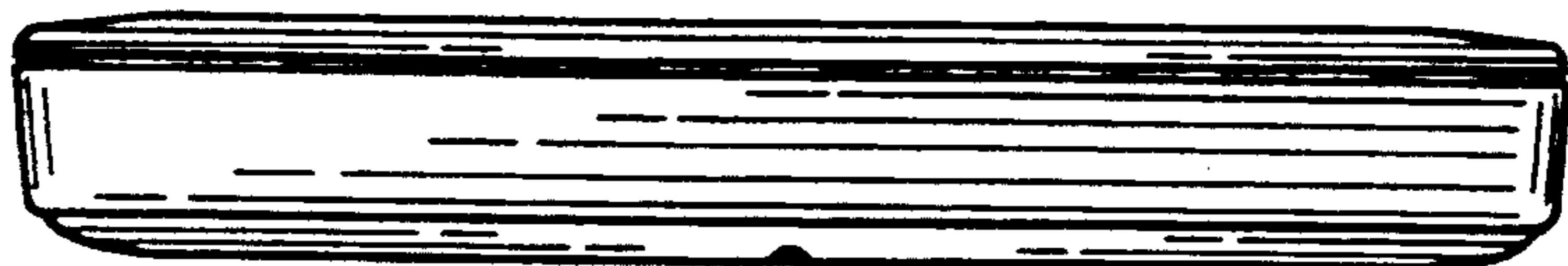

Fig. 126

Fig. 127

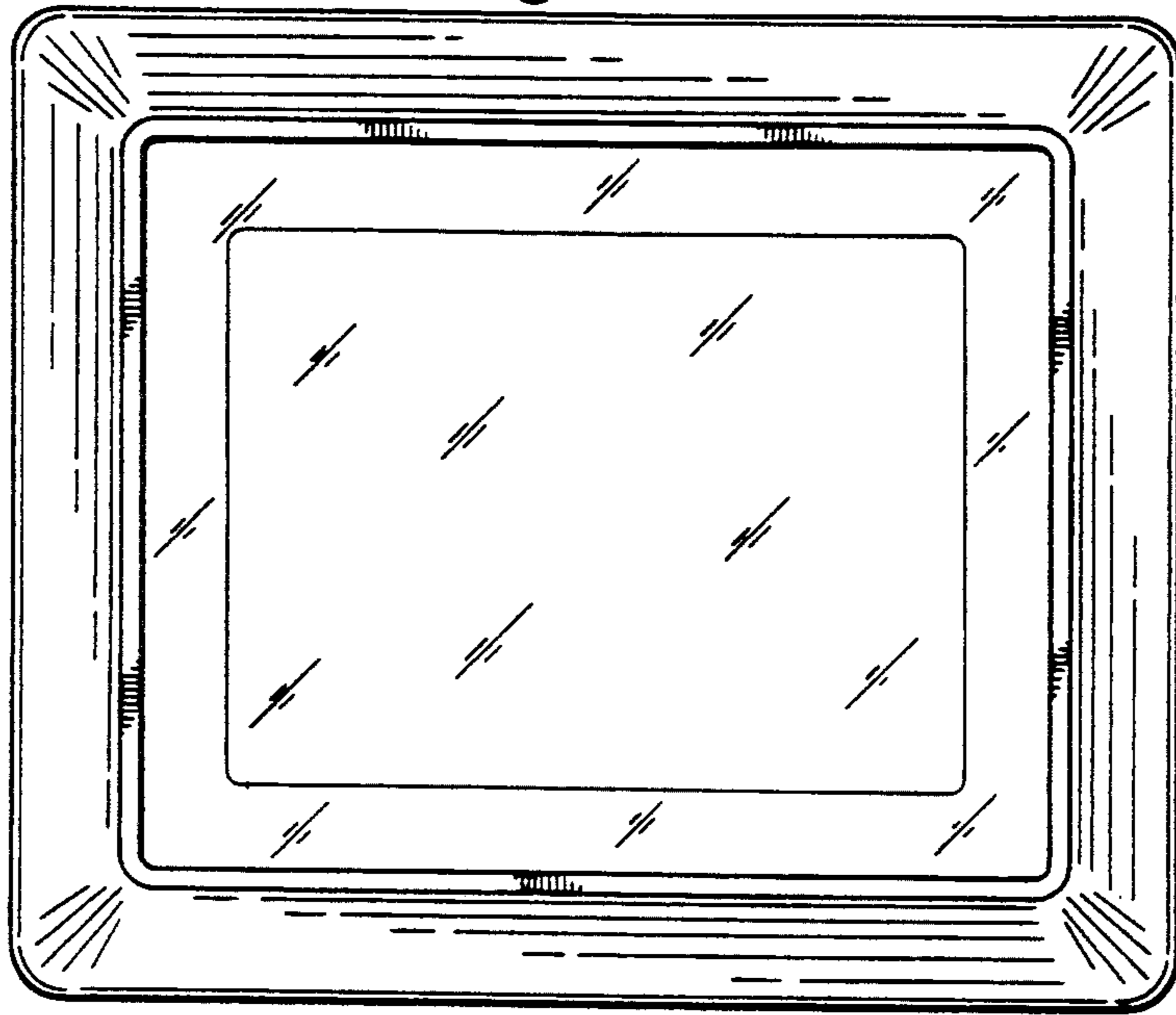

Fig. 128

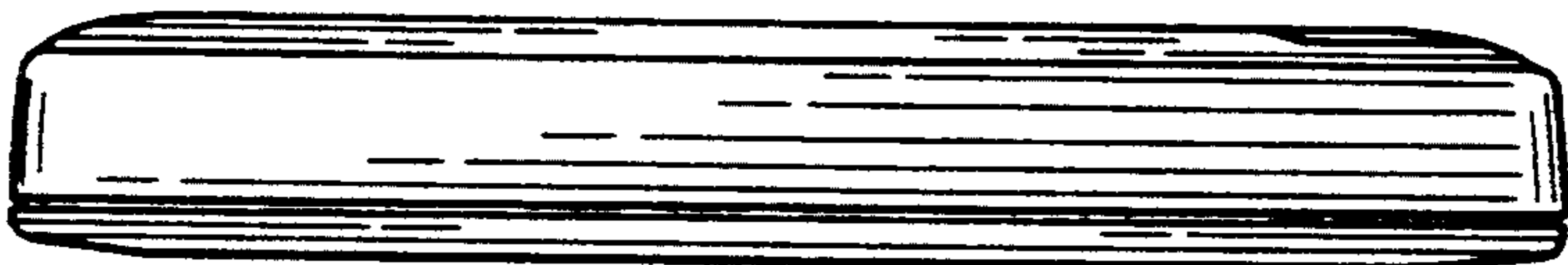
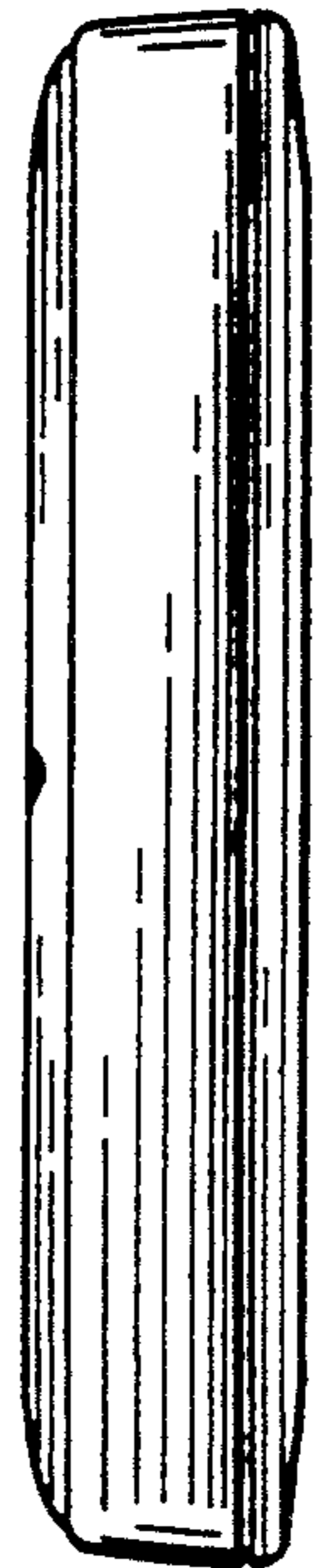

Fig. 129



Fig. 131

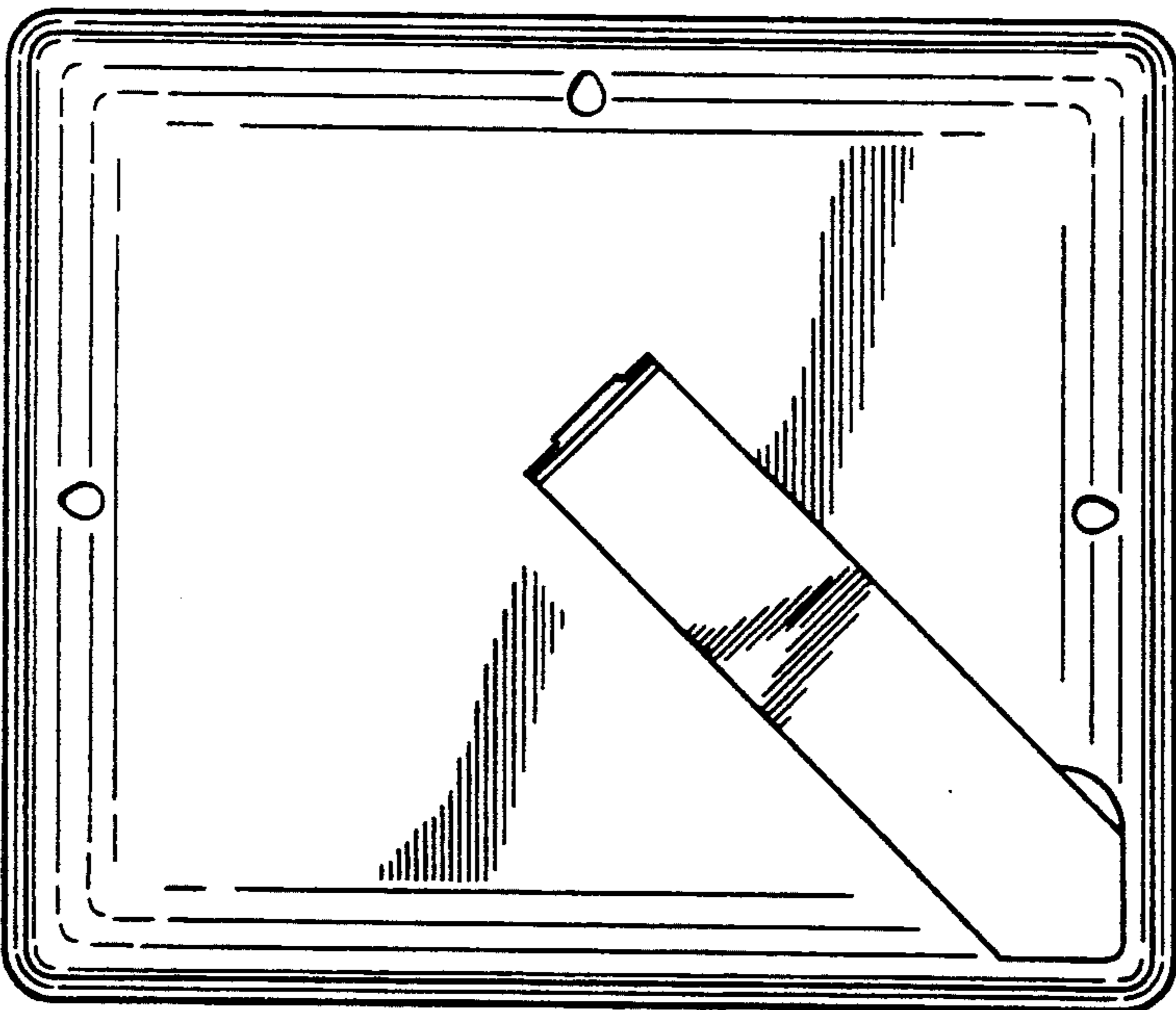

Fig. 130

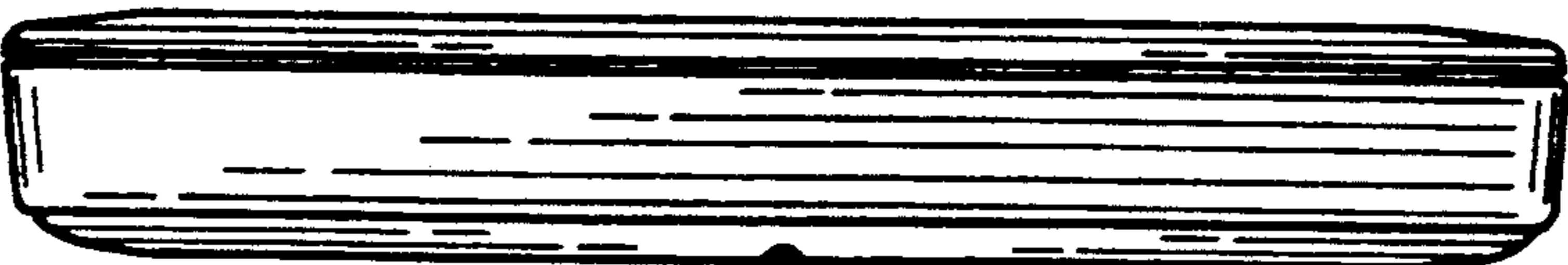

Fig. 132

Fig. 133

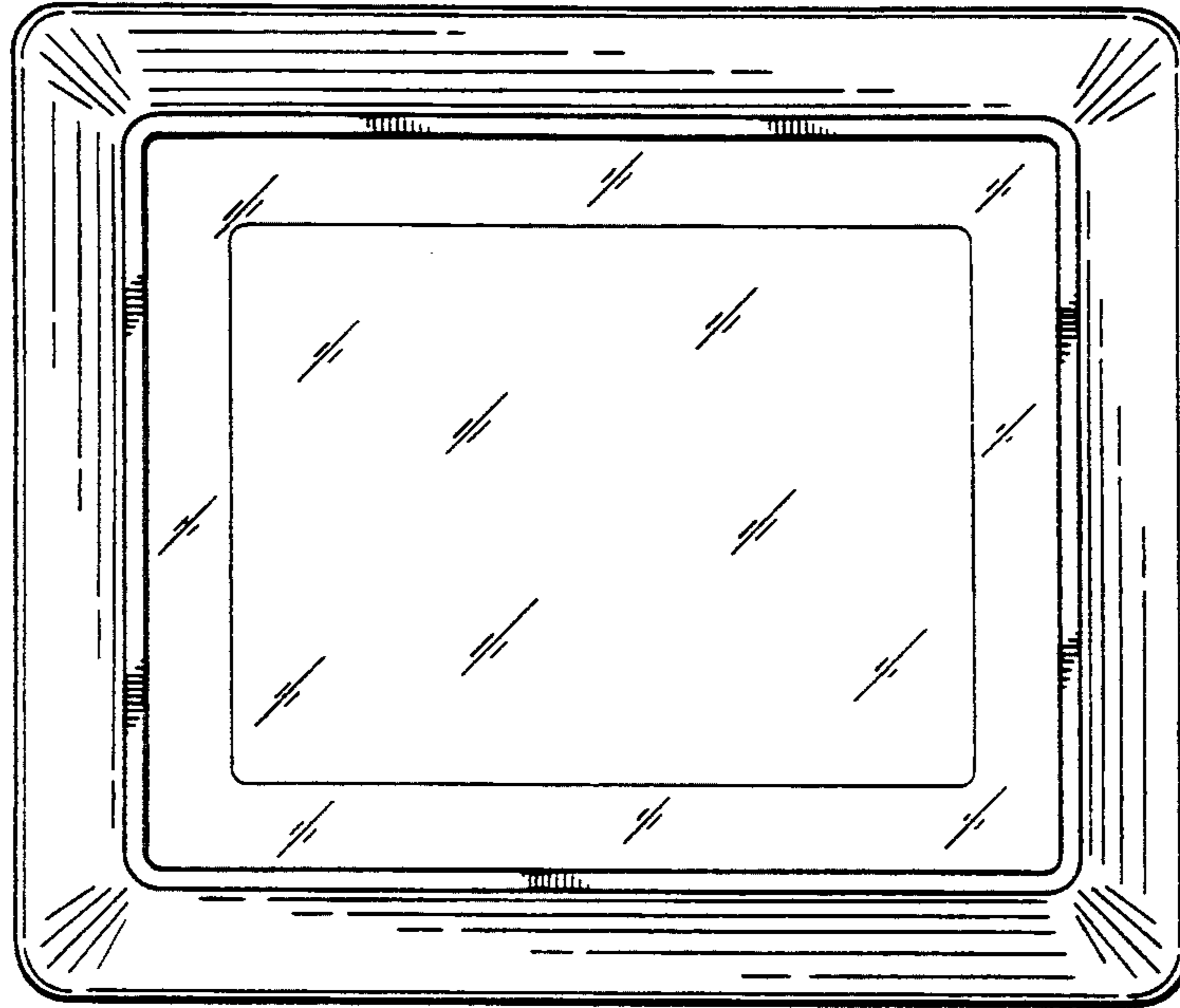

Fig. 134

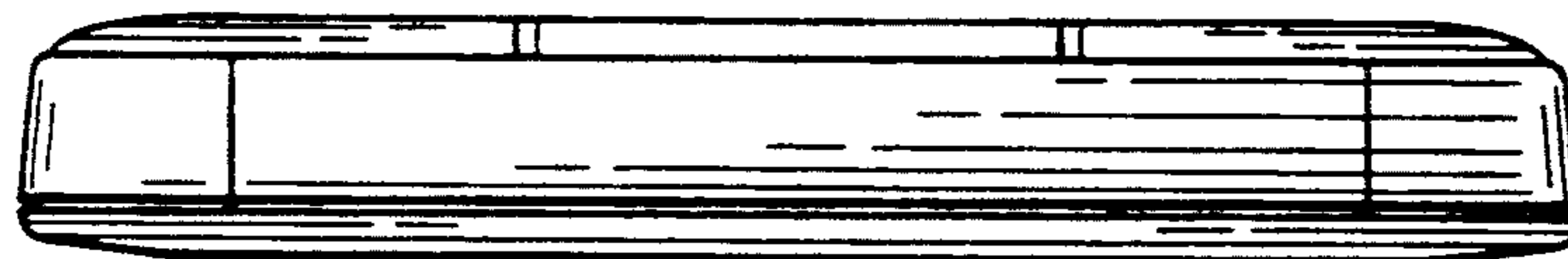
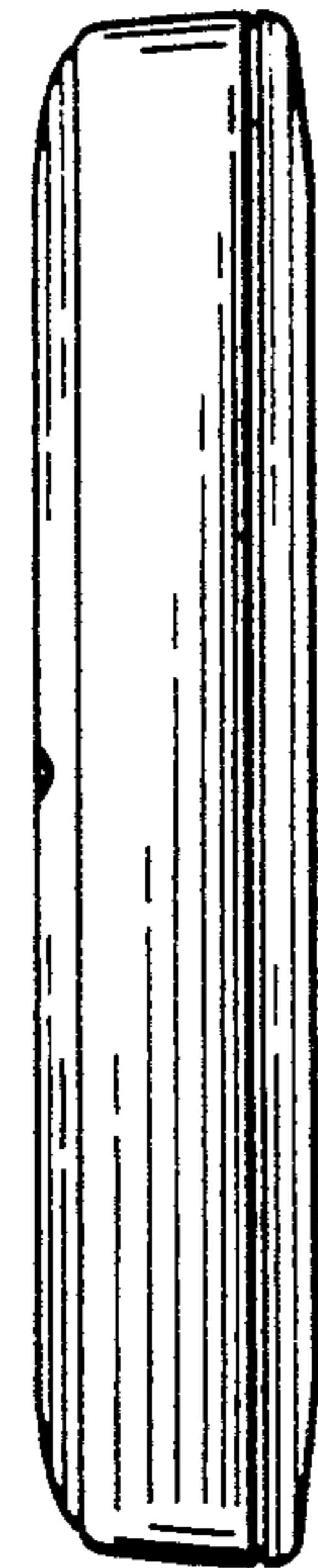

Fig. 135



Fig. 137

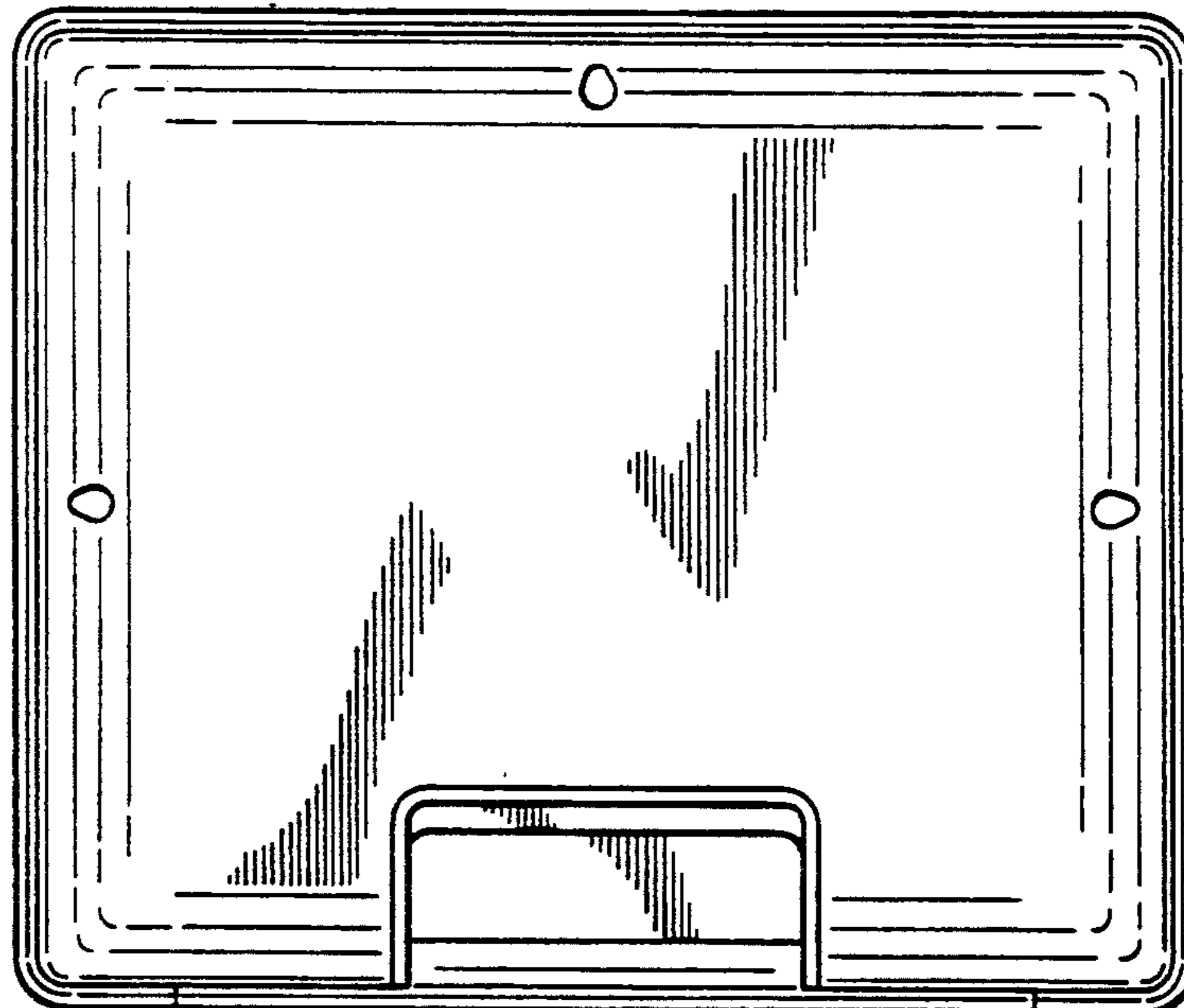

Fig. 136

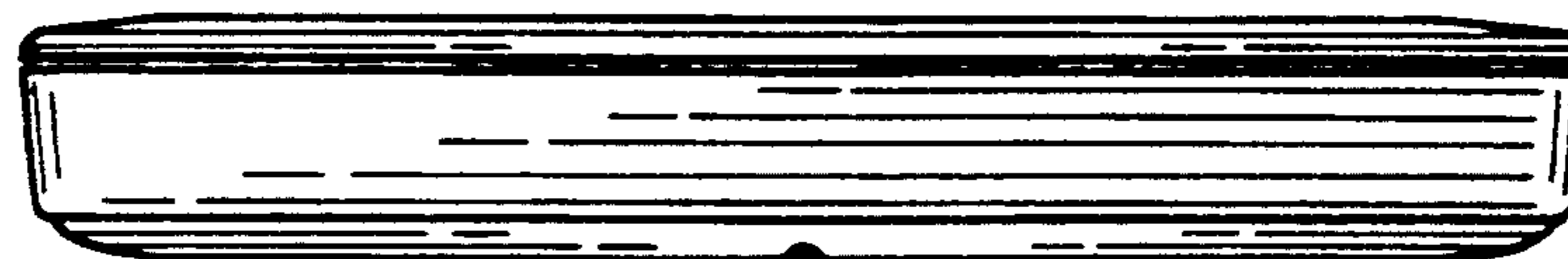

Fig. 138

Fig. 139

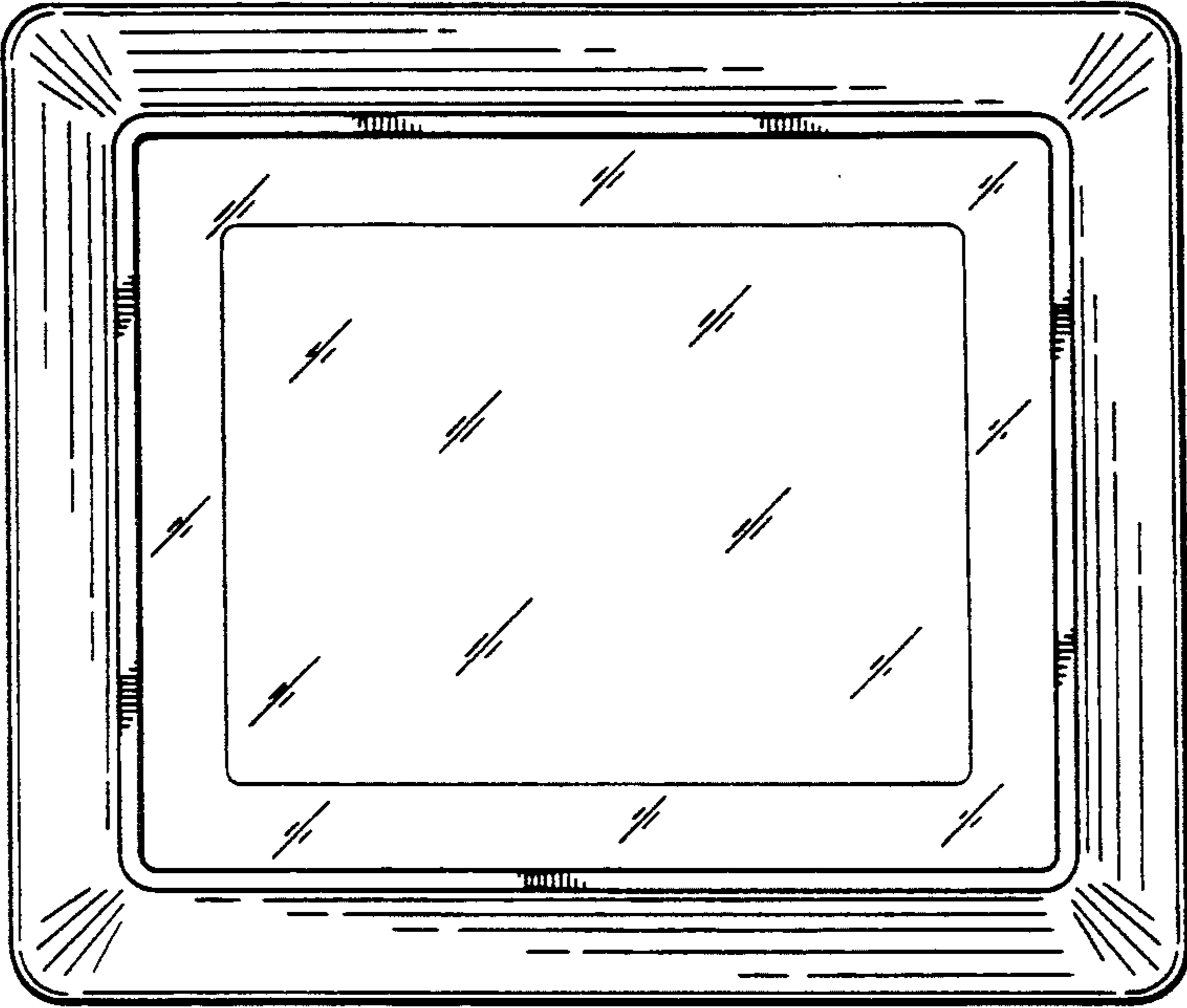

Fig. 140

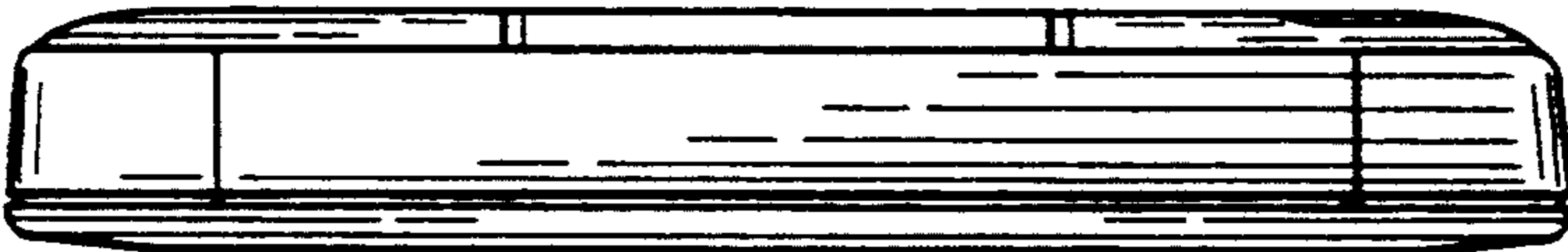

Fig. 141



Fig. 143

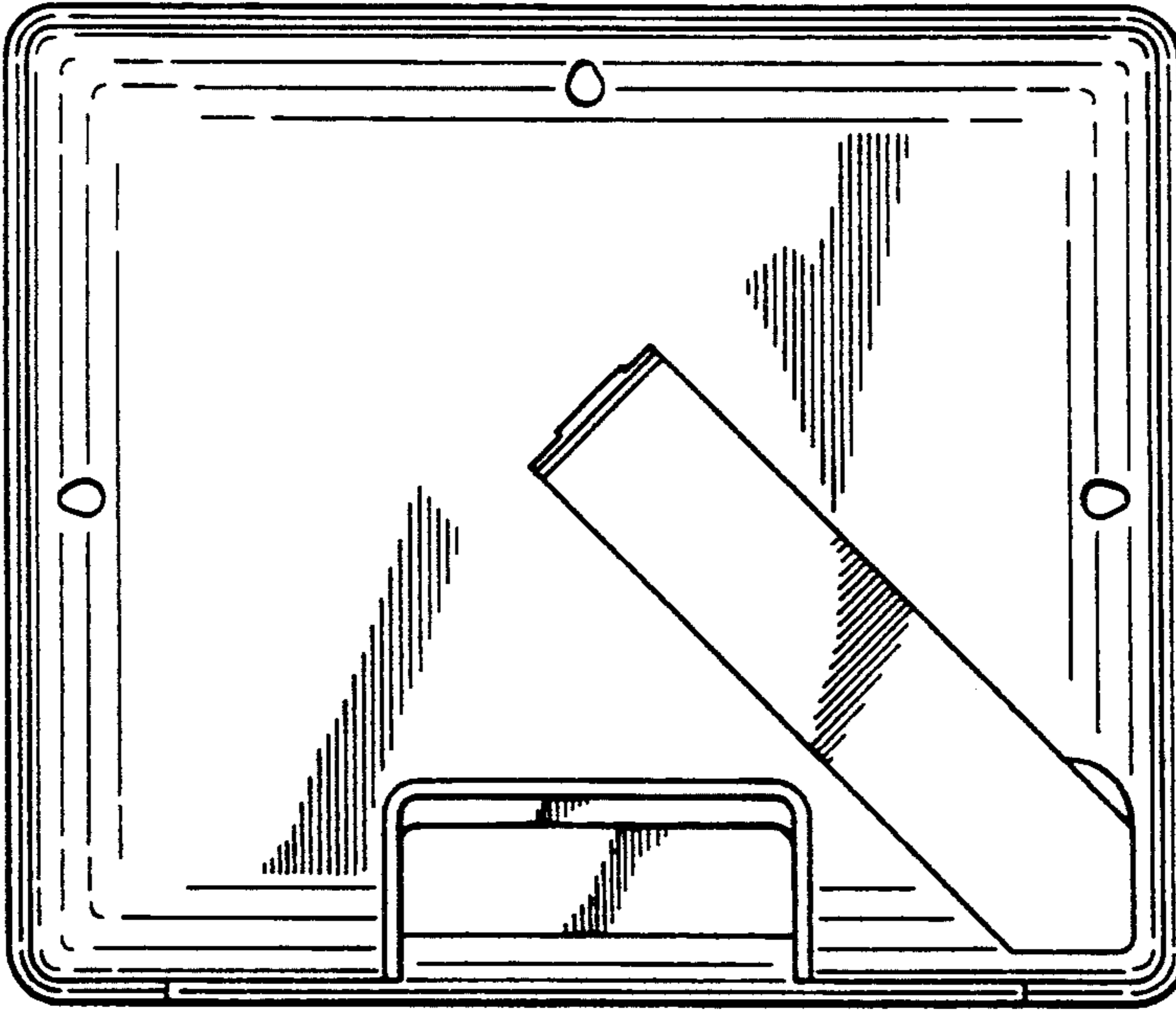

Fig. 142

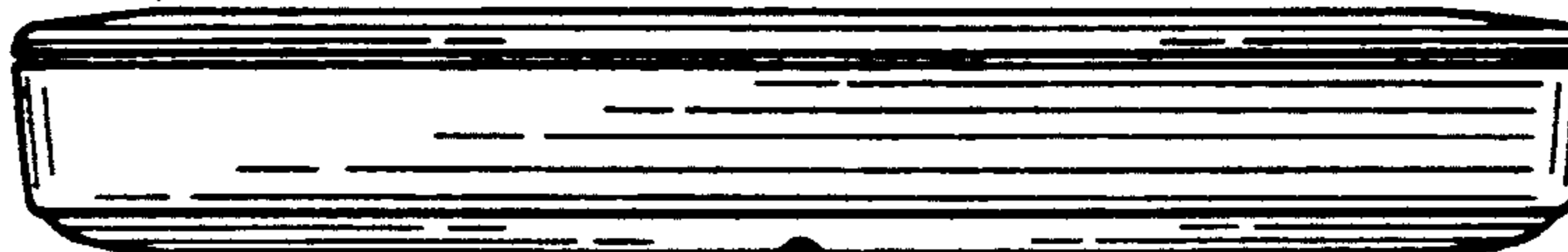

Fig. 144

Fig. 145

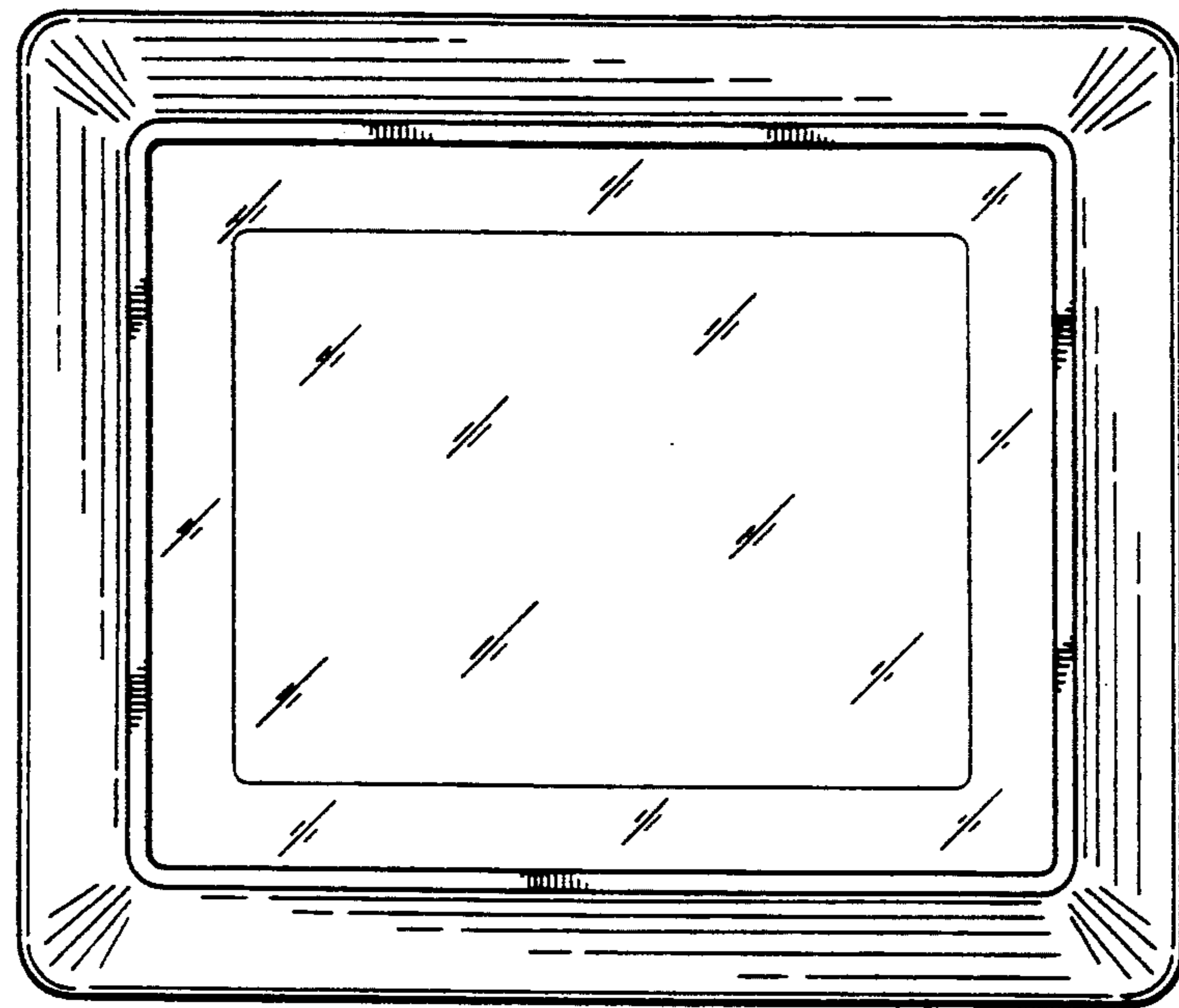

Fig. 146

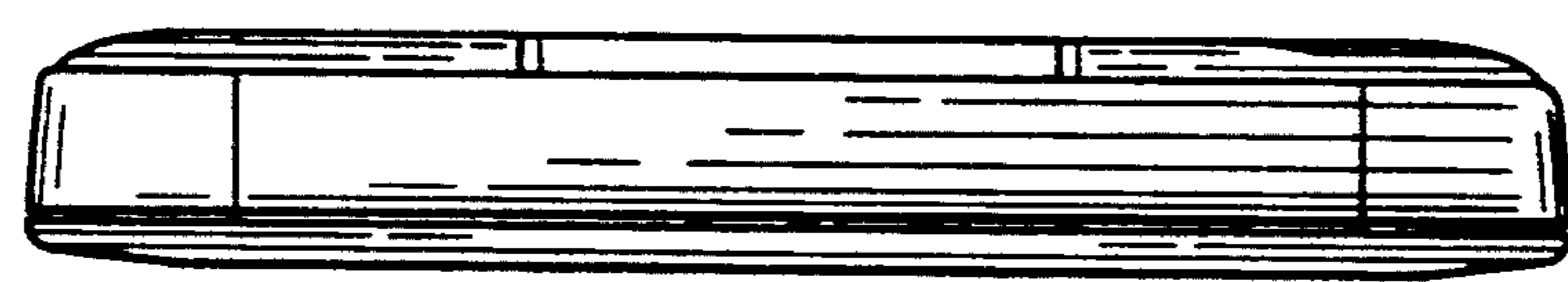
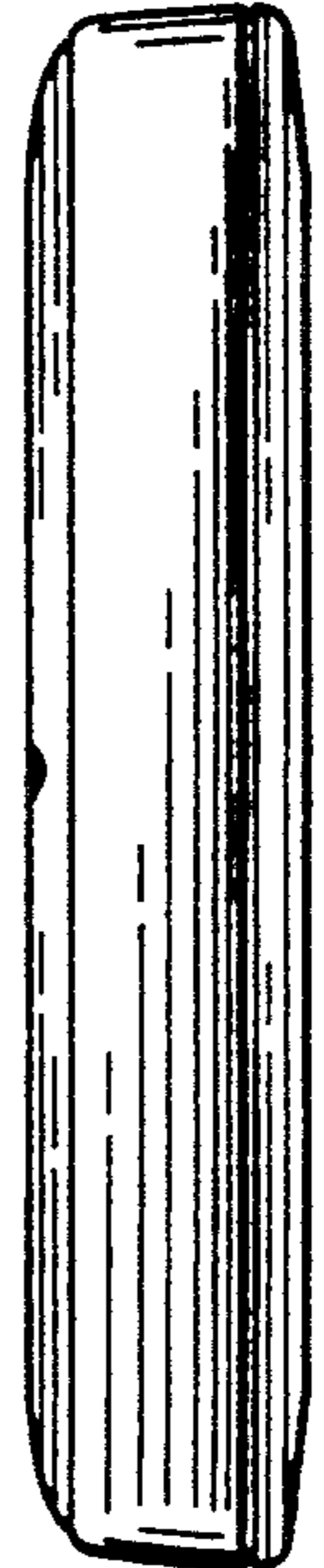

Fig. 147



Fig. 149

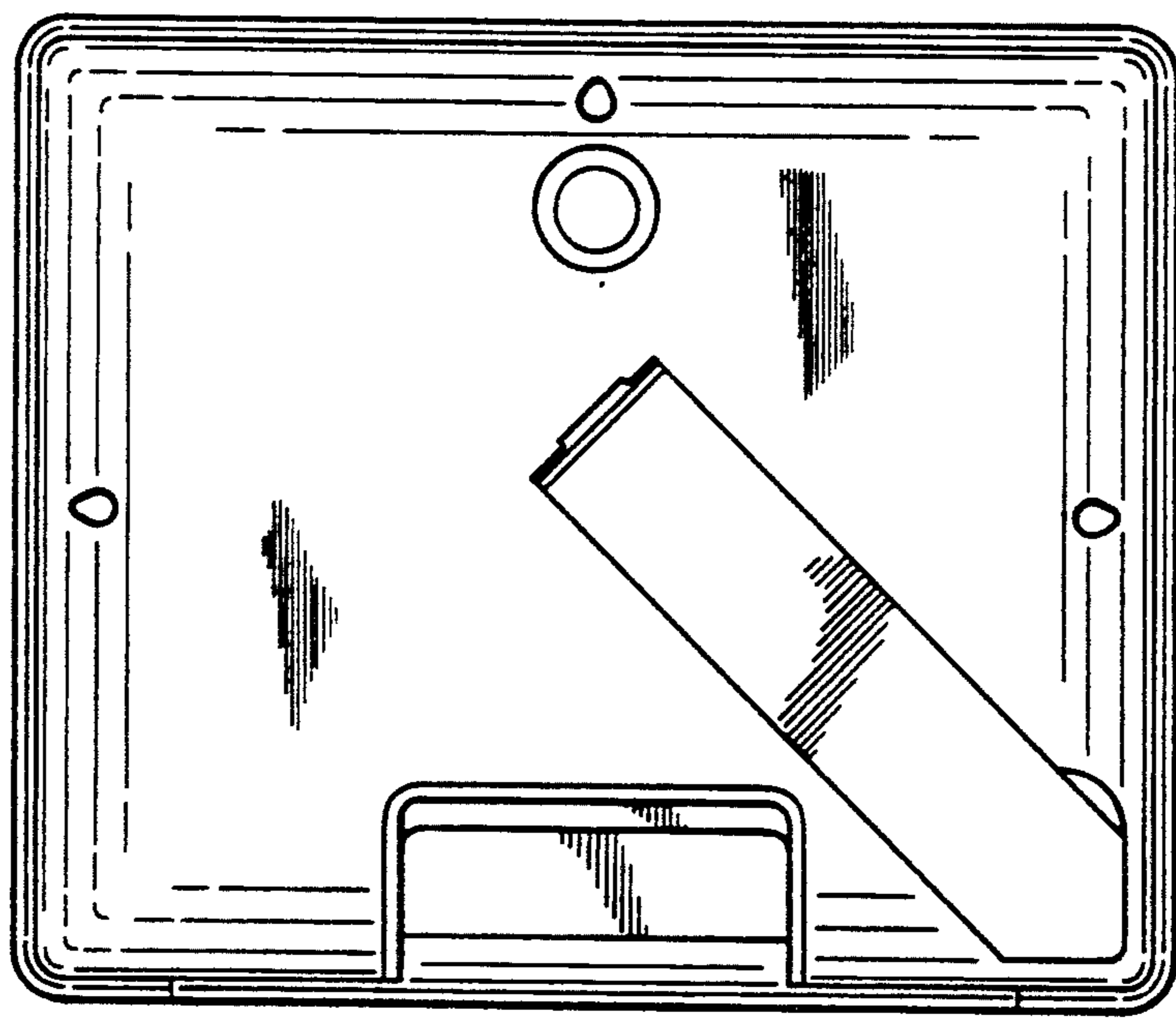

Fig. 148

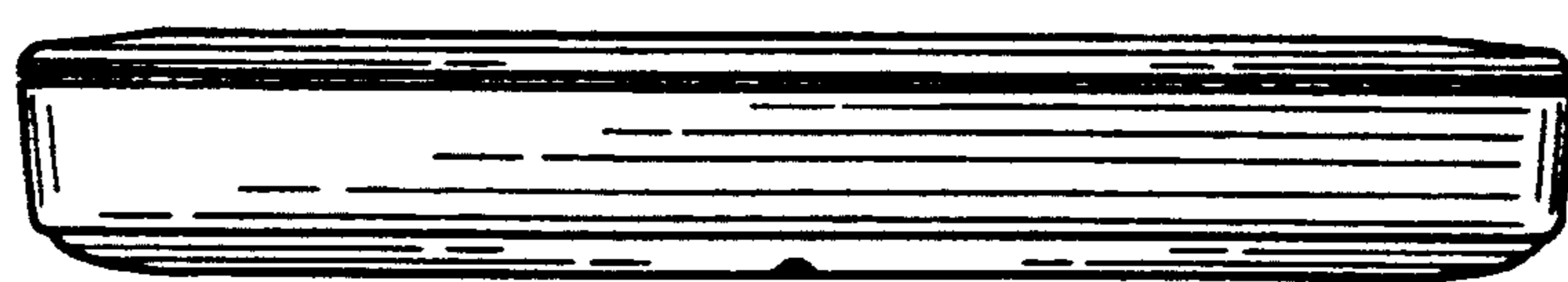

Fig. 150

Fig. 151

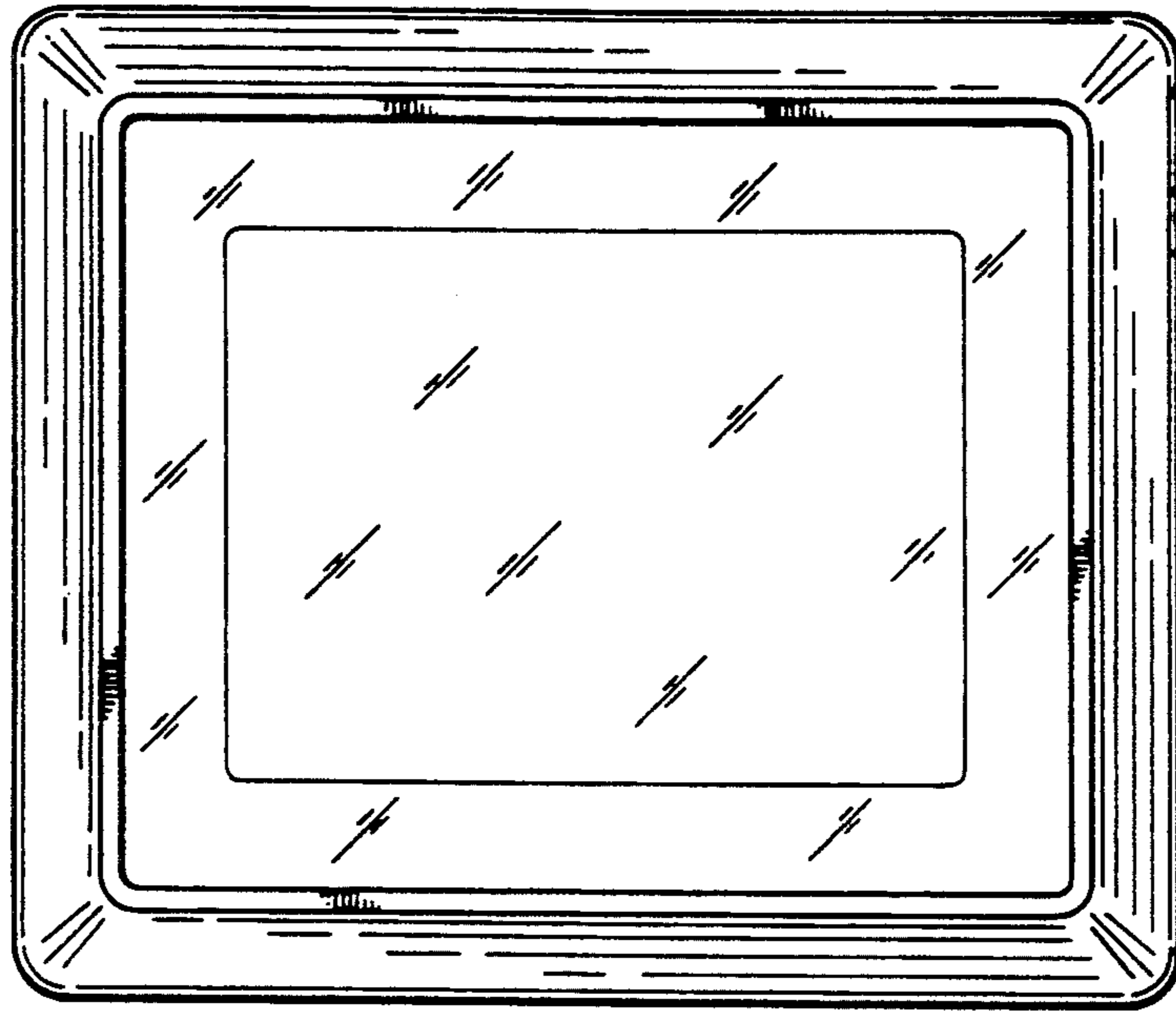

Fig. 152

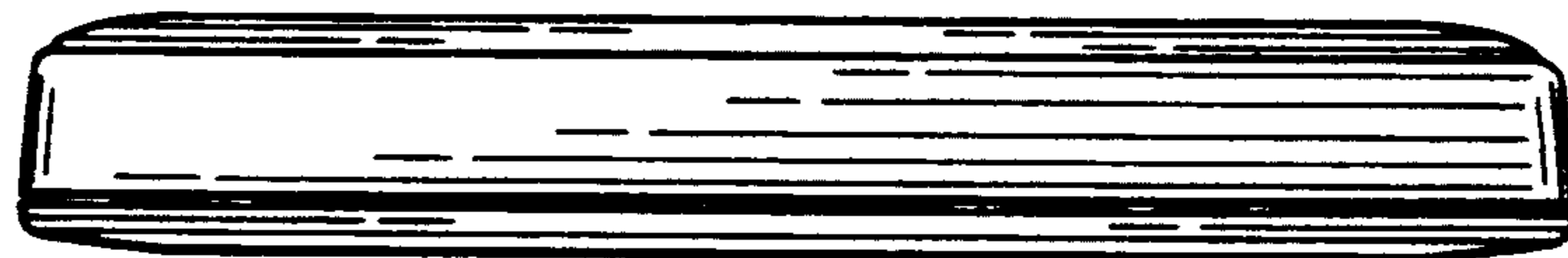

Fig. 153



Fig. 155

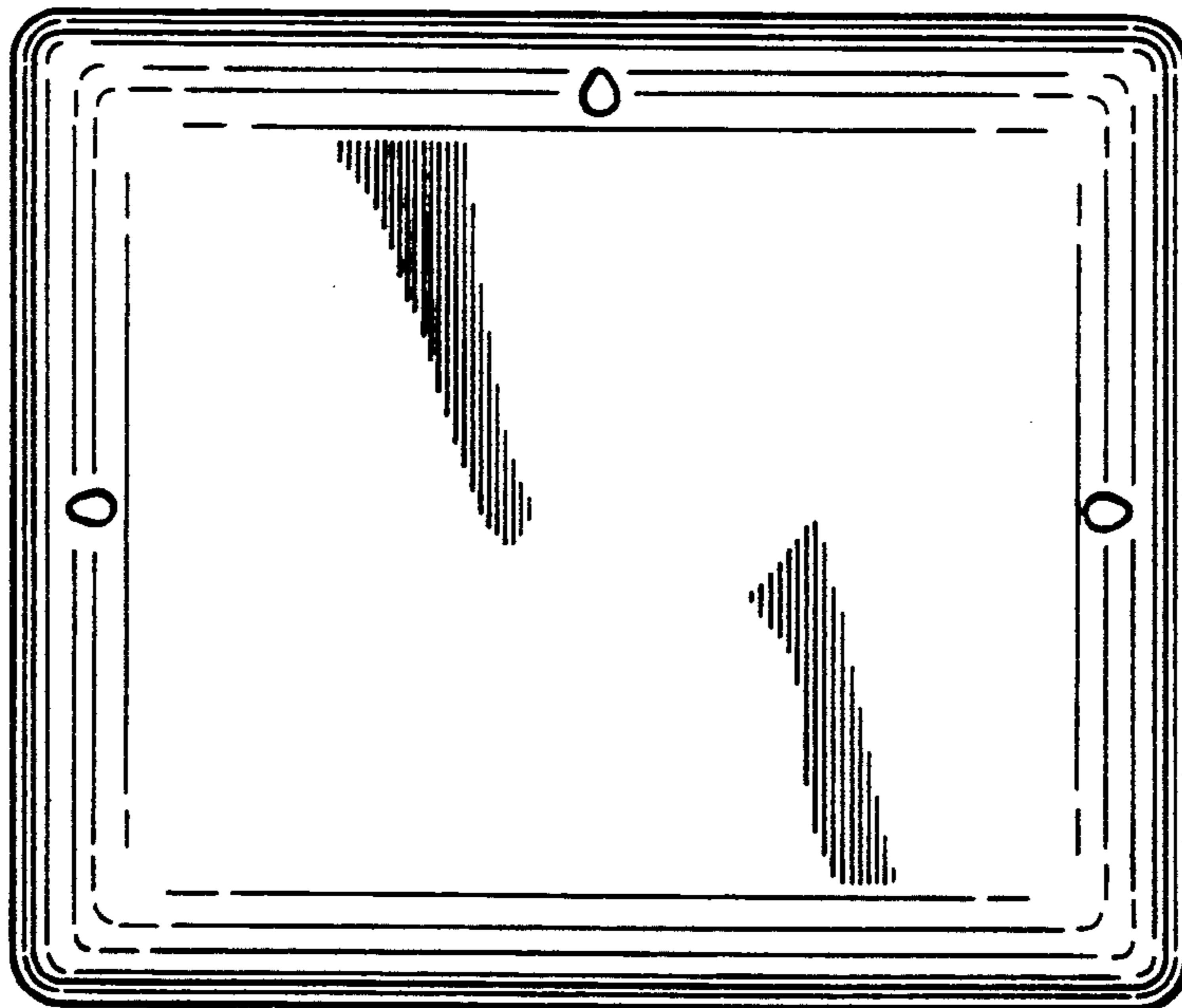

Fig. 154

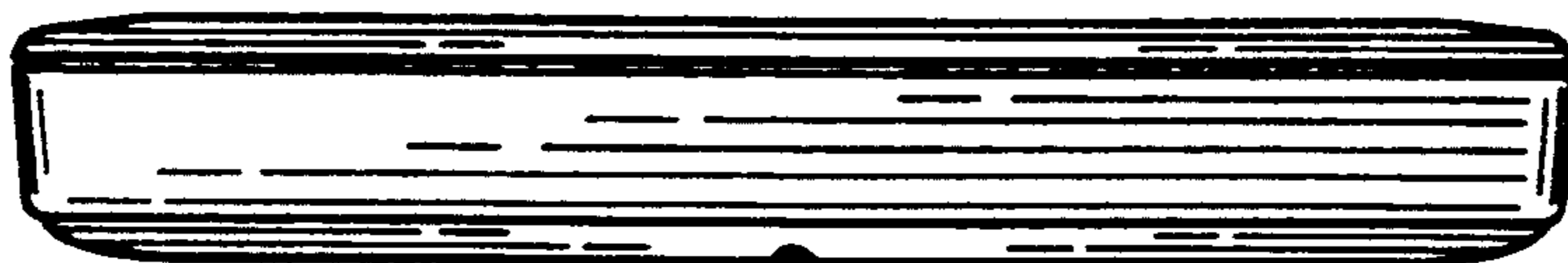

Fig. 156

Fig. 157

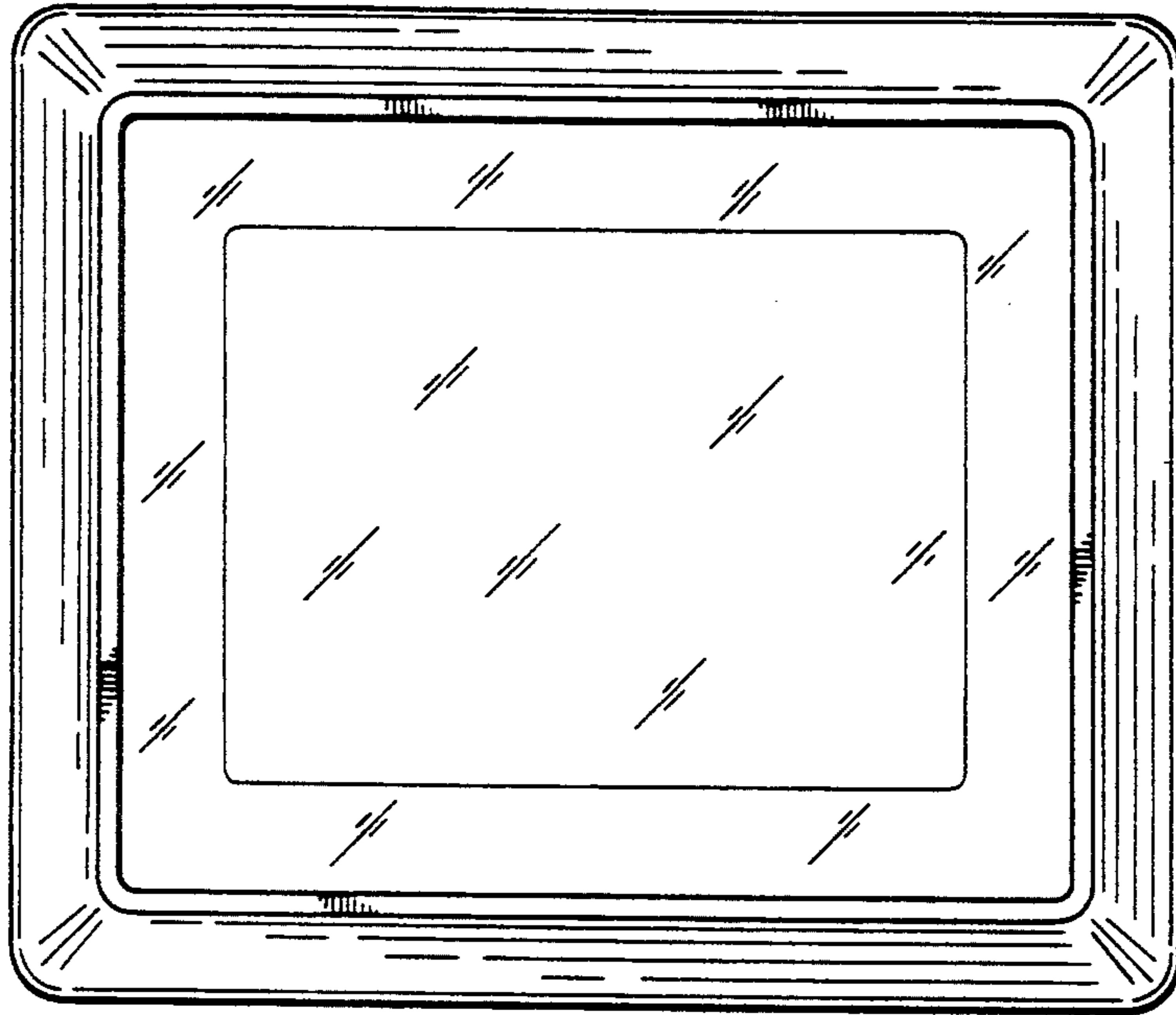

Fig. 158

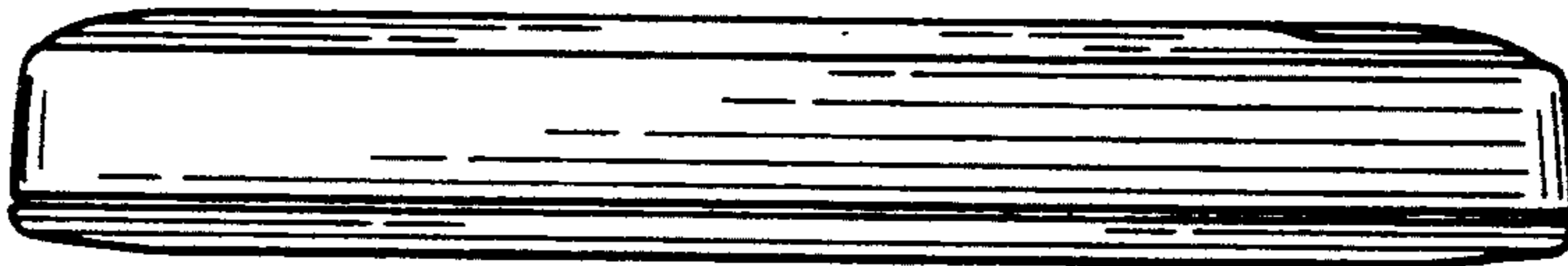
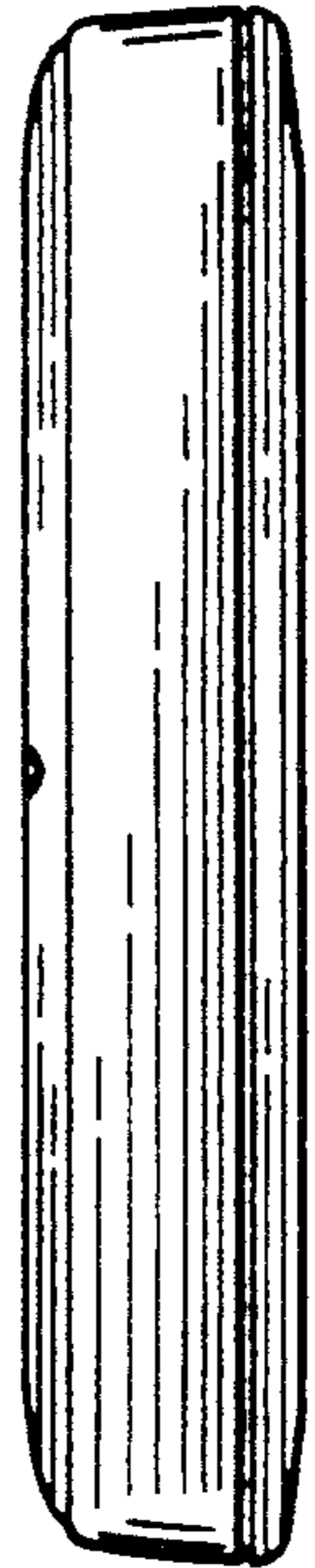

Fig. 159



Fig. 161

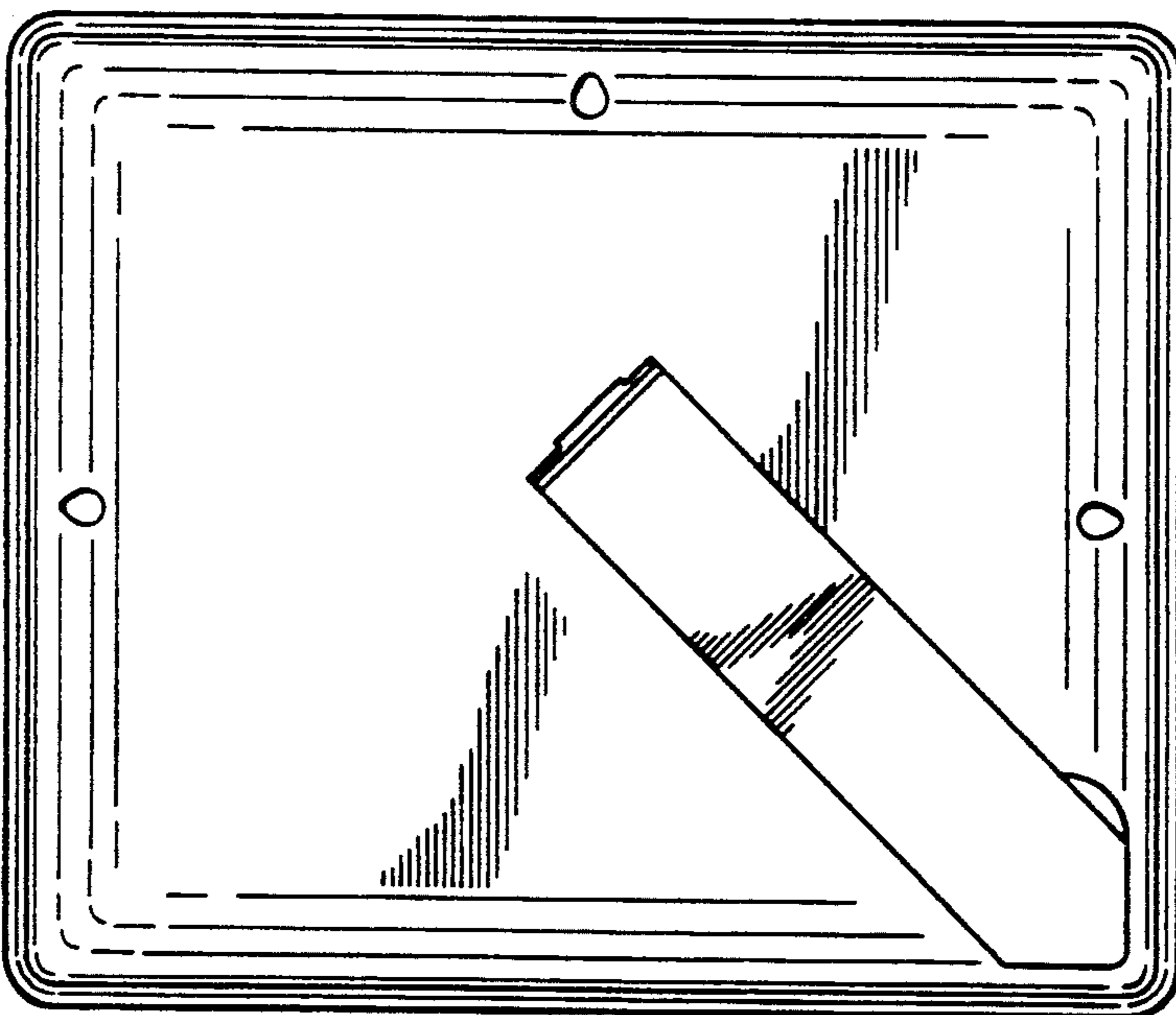

Fig. 160

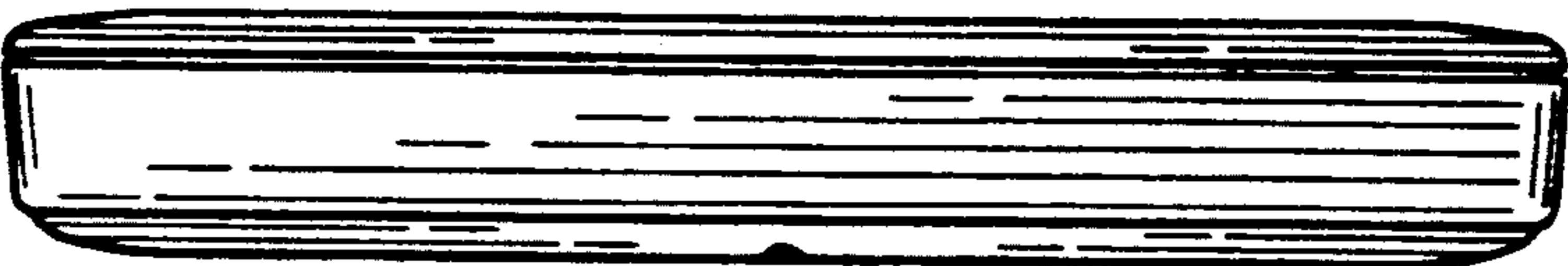

Fig. 162

Fig. 163

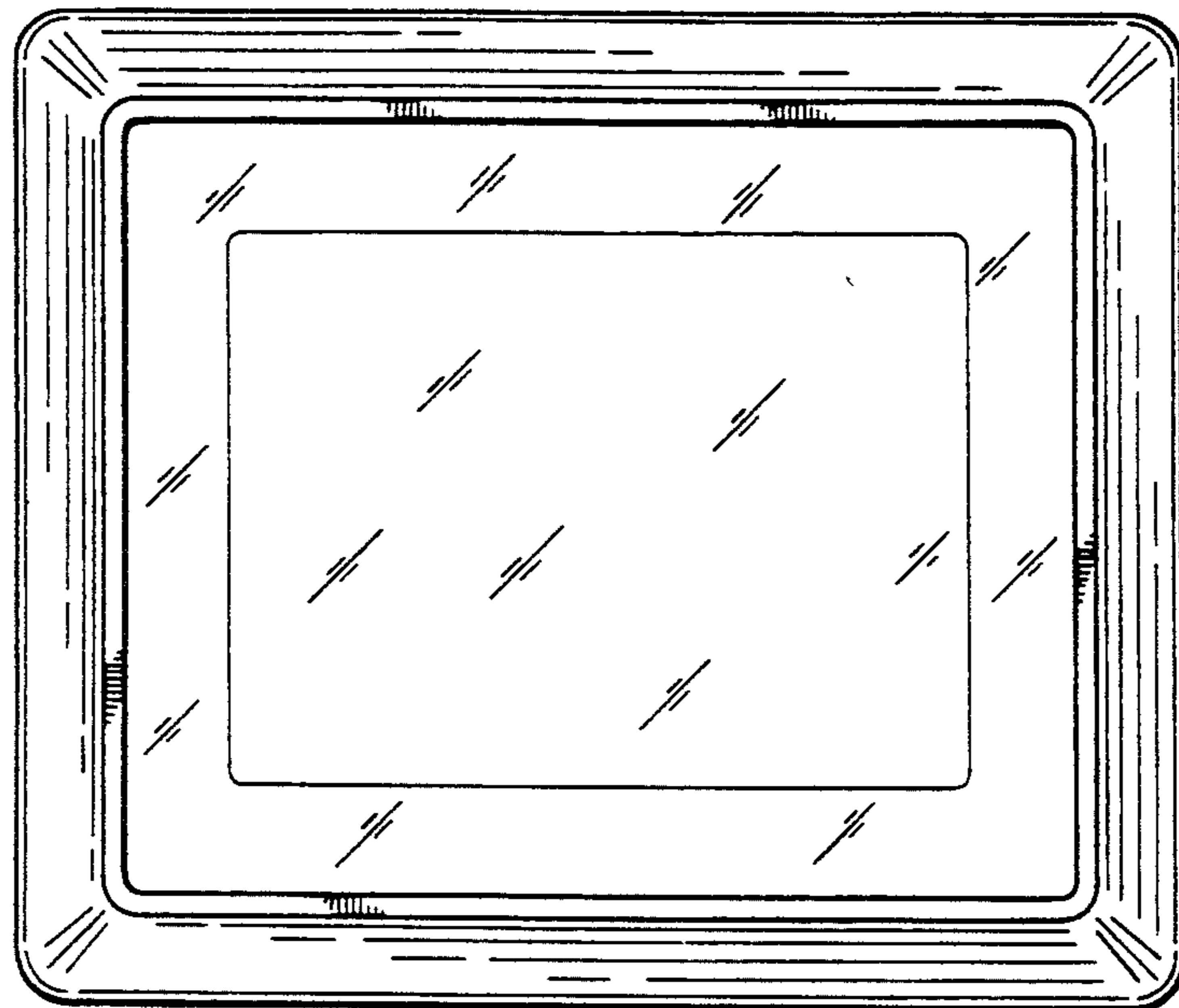

Fig. 164

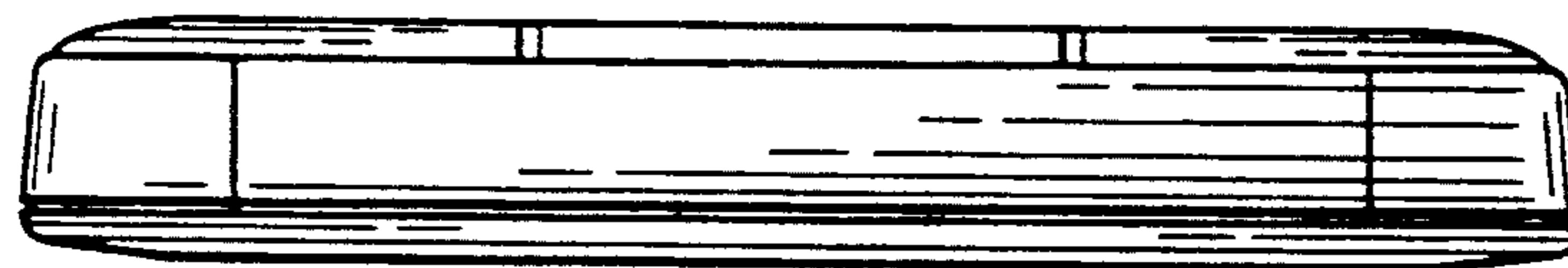
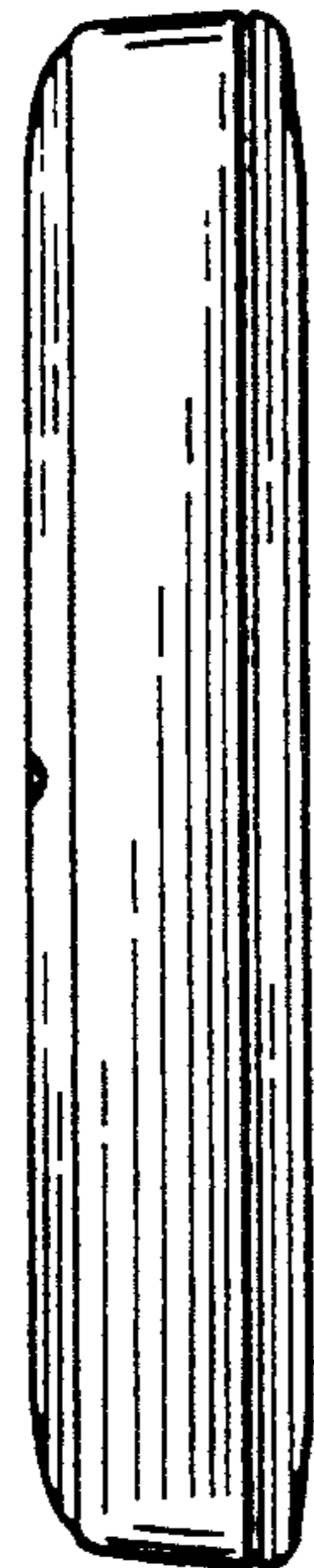

Fig. 165



Fig. 167

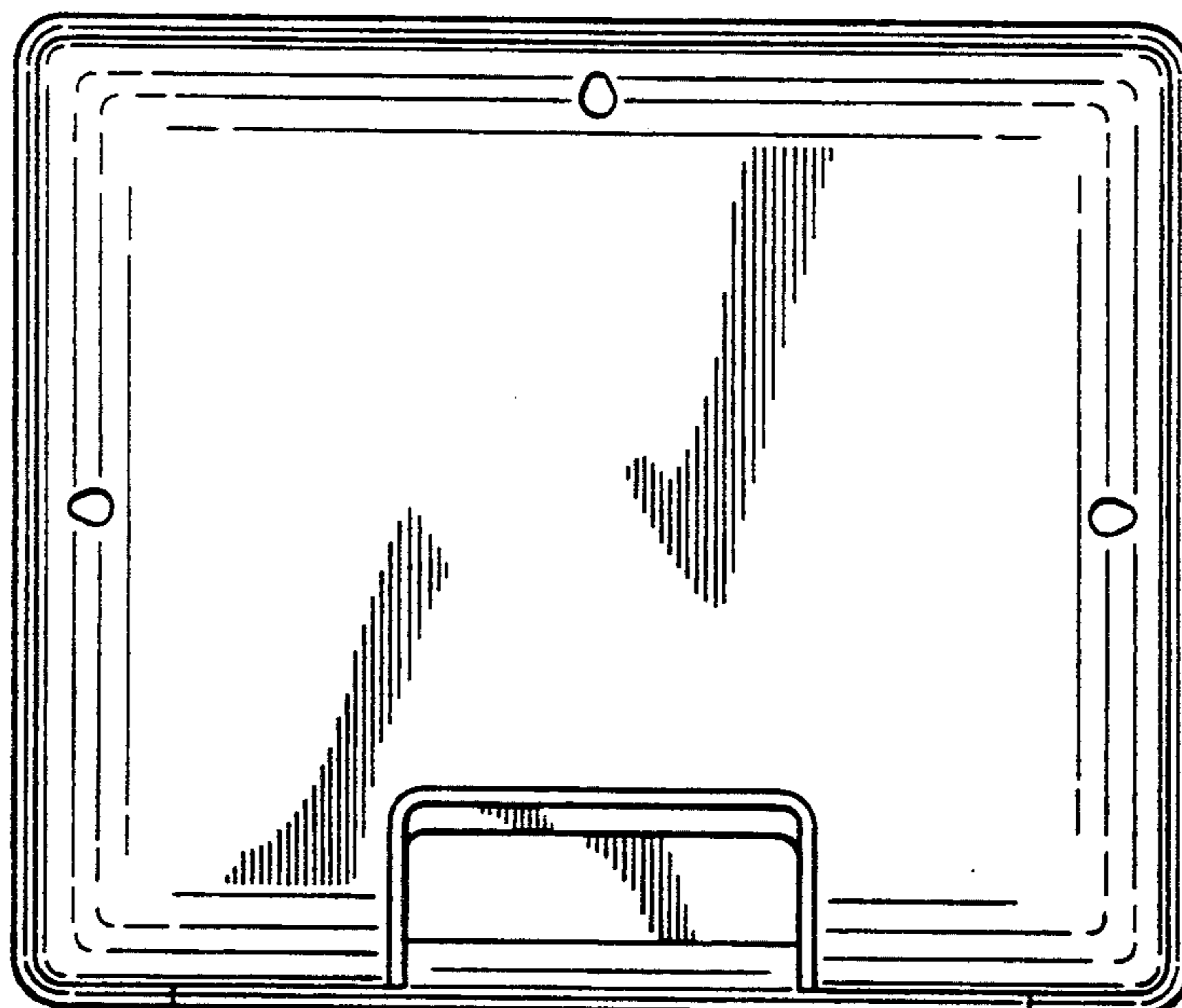

Fig. 166

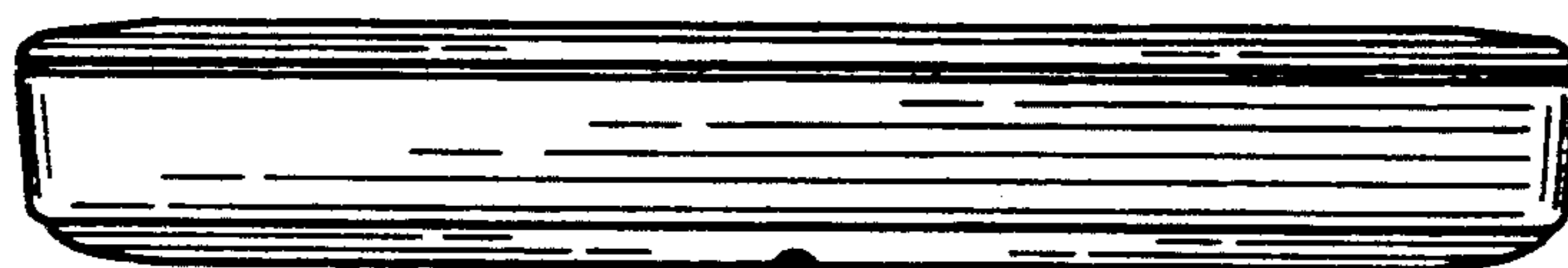

Fig. 168

Fig. 169

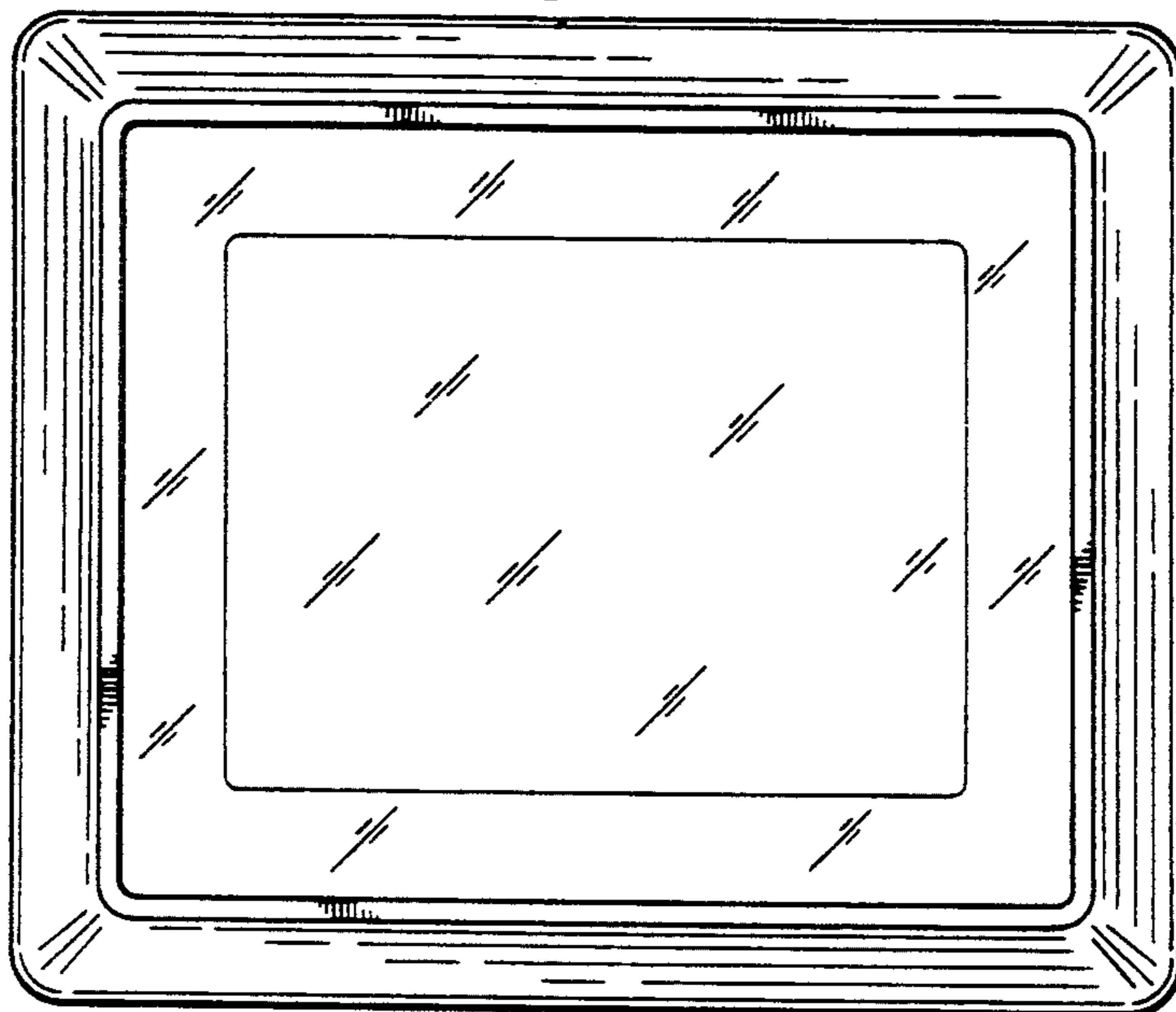

Fig. 170

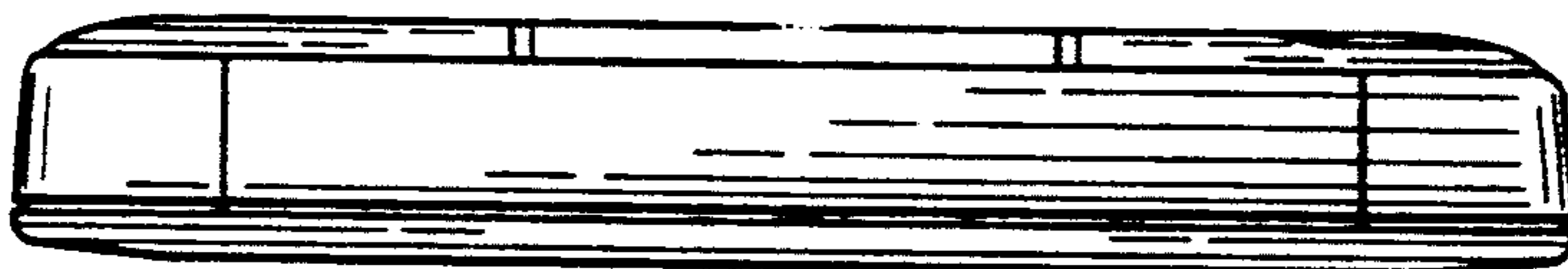

Fig. 171



Fig. 173

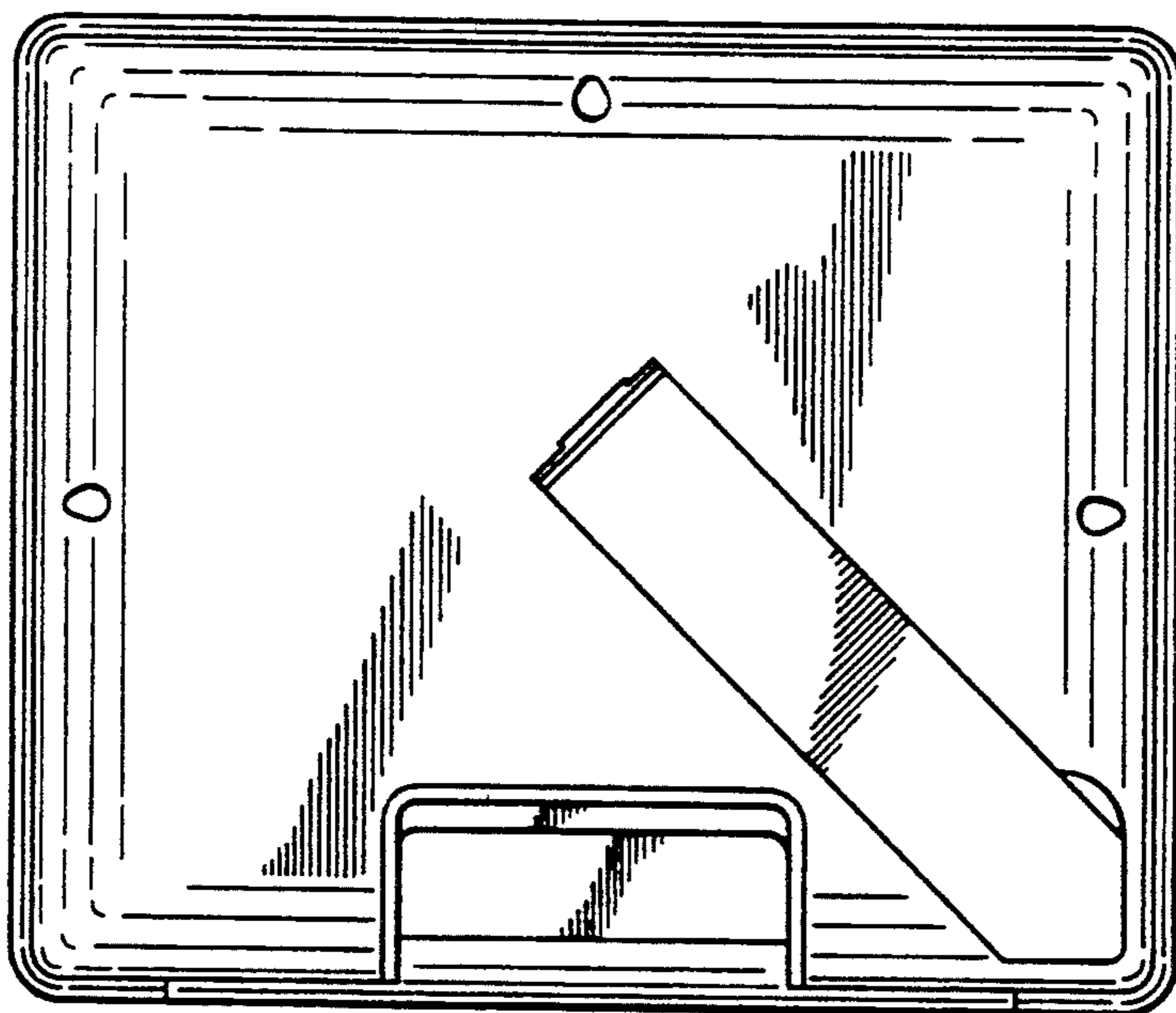

Fig. 172

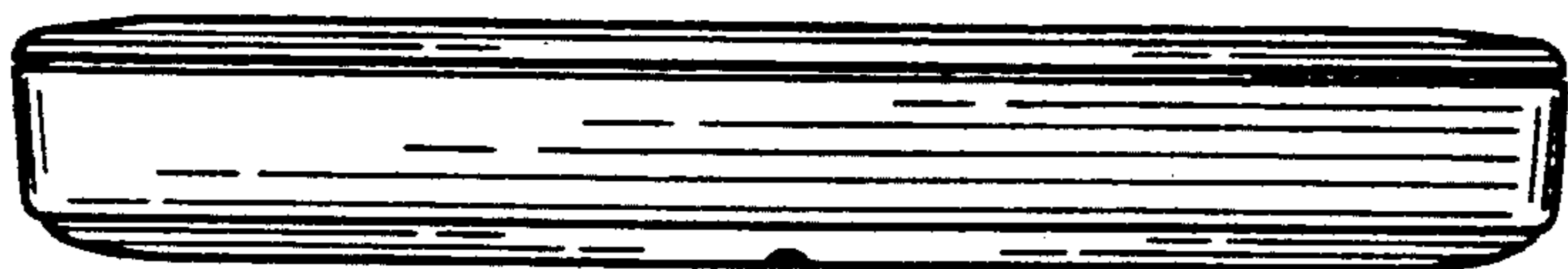

Fig. 174

Fig. 175

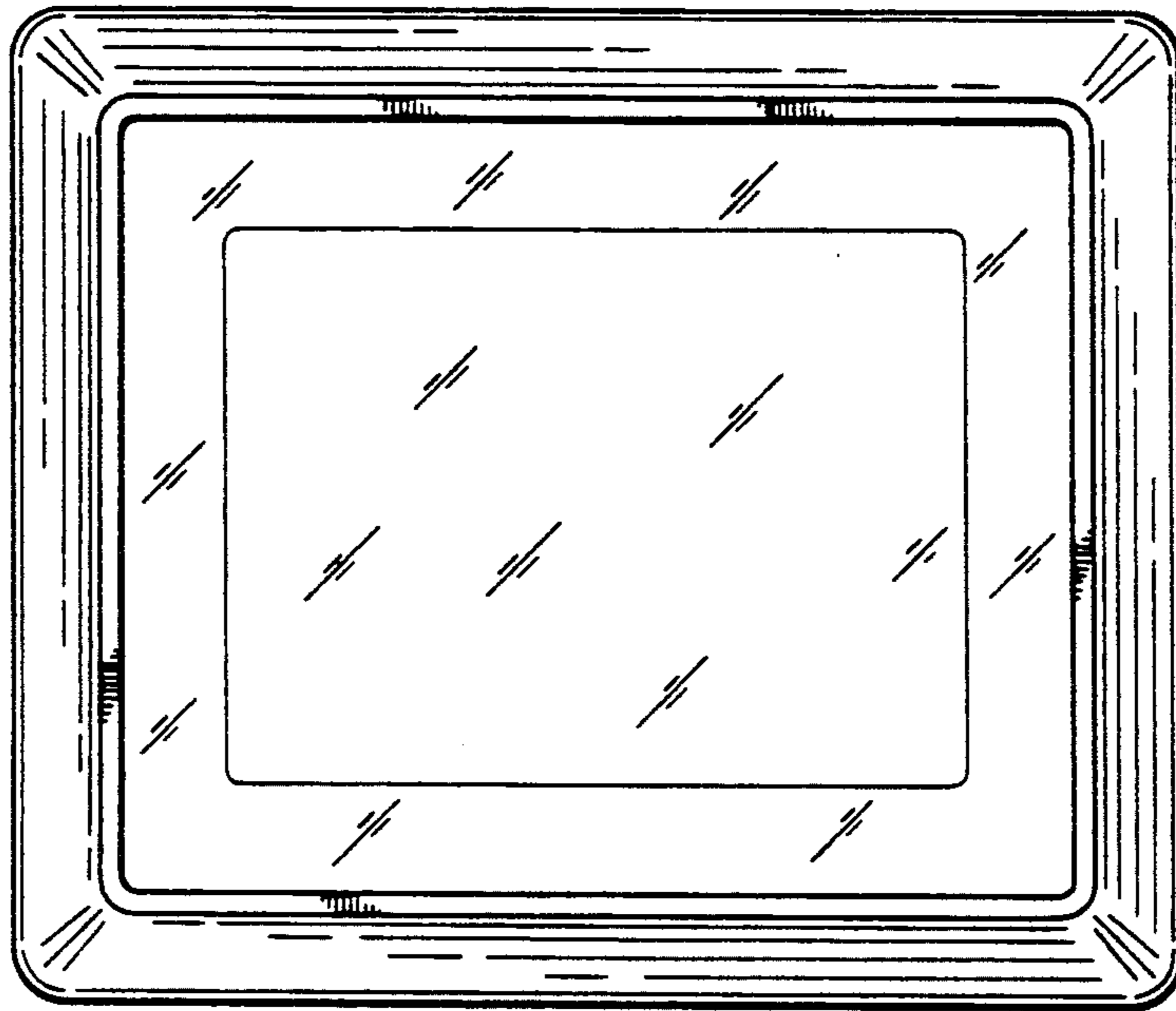

Fig. 176

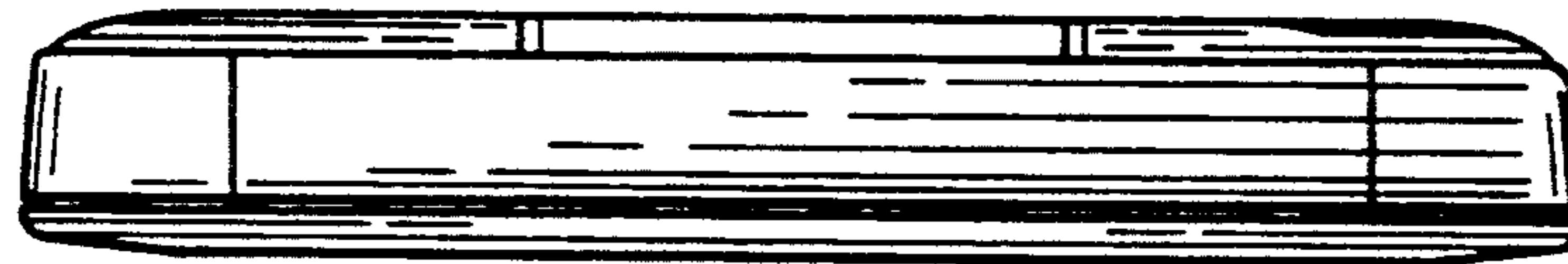
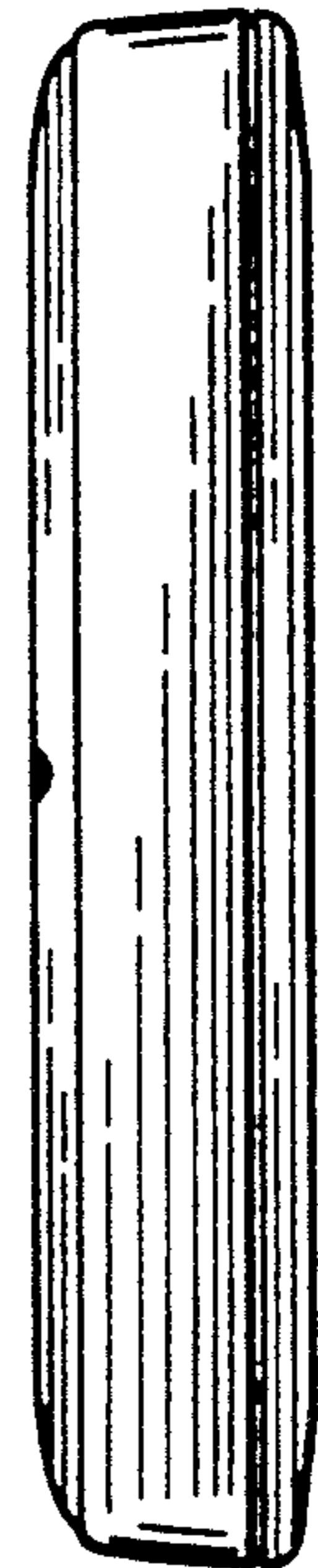

Fig. 177



Fig. 179

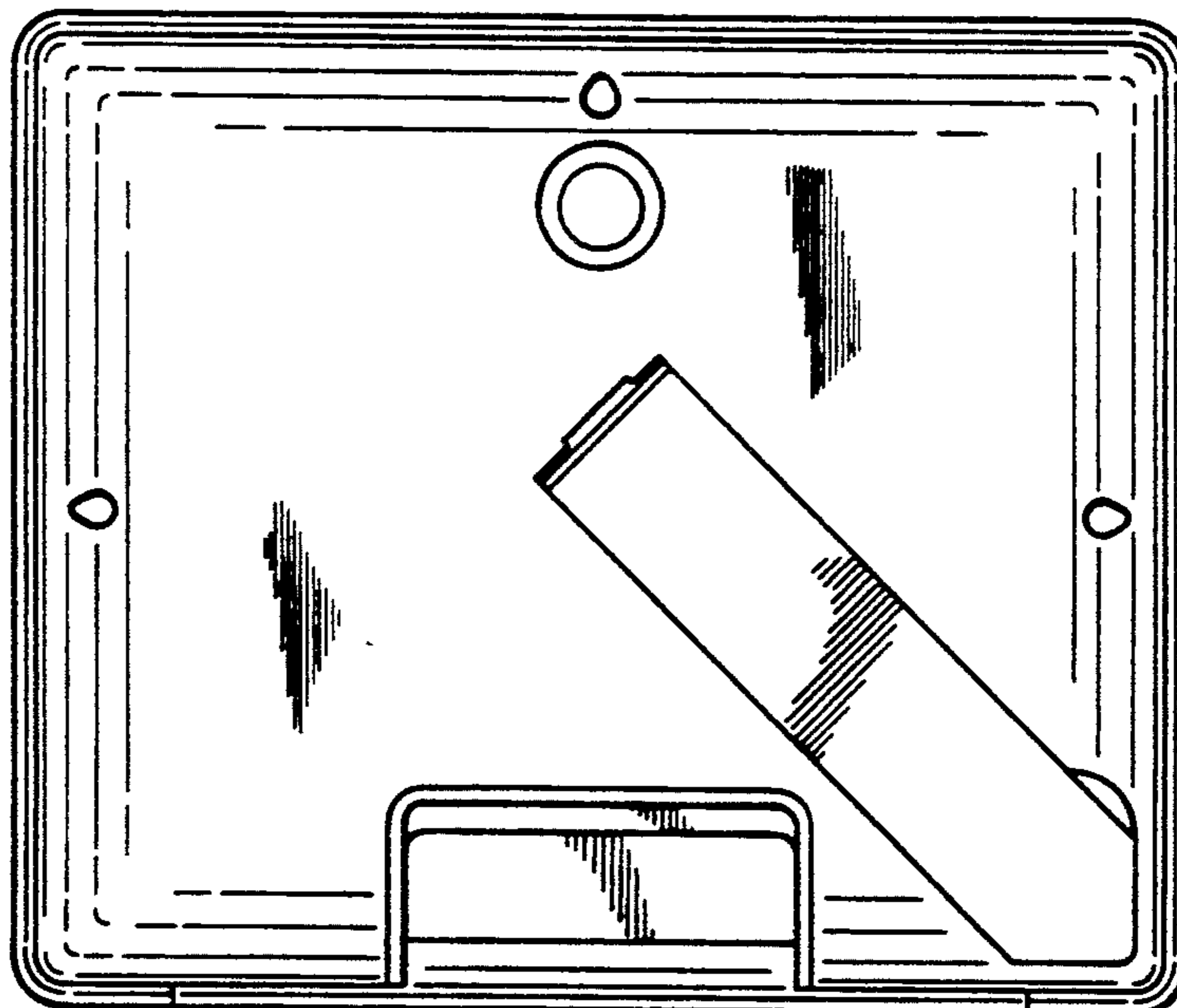

Fig. 178

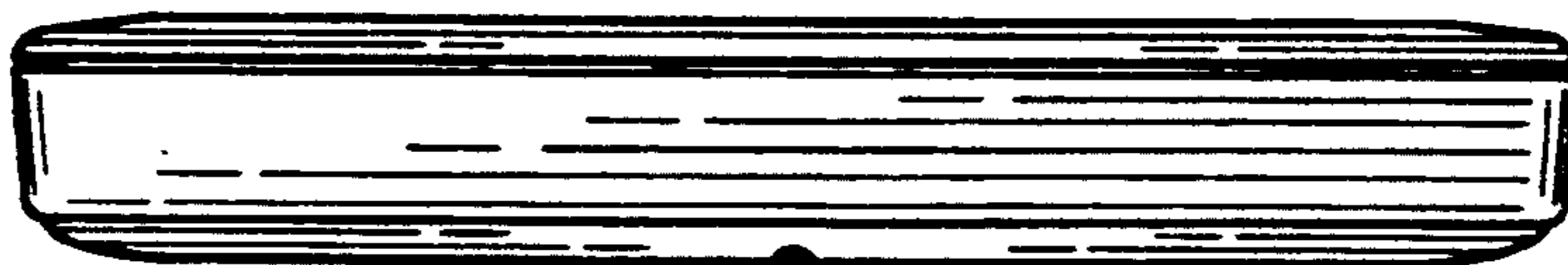

Fig. 180