



US00D329158S

United States Patent [19]

[11] Patent Number: **Des. 329,158**

Tuzi

[45] Date of Patent: **** Sep. 8, 1992**

[54] **BATHROOM CORNER SHELF UNIT**

2,522,442 9/1950 Garris 108/42
3,008,585 11/1961 McNeill 108/42
3,054,212 9/1962 Morris D6/540 X

[76] Inventor: **Gino Tuzi**, 5 Oldham Crescent,
Brampton, Ontario, L6Z 1W2,
Canada

OTHER PUBLICATIONS

Lillian Vernon Catalogue, p. 27, top right item.

[**] Term: **14 Years**

Primary Examiner—James R. Largen

[21] Appl. No.: **426,360**

Attorney, Agent, or Firm—Moss, Barrigar & Oyen

[22] Filed: **Oct. 24, 1989**

[57] **CLAIM**

[30] **Foreign Application Priority Data**

The ornamental design for a bathroom corner shelf unit,
as shown and described.

Sep. 29, 1989 [CA] Canada 20-09-89-2

[52] U.S. Cl. **D6/562; D6/525**

DESCRIPTION

[58] Field of Search **D23/303-313;**
D6/524, 525, 527, 529, 533, 540, 553, 562, 569,
570, 574; 108/42; 211/90, 134; 248/220.1

FIG. 1 is a perspective view taken from the top and
front of a bathroom corner shelf unit showing my new
design;

[56] **References Cited**

U.S. PATENT DOCUMENTS

- D. 137,897 5/1944 Veltheer et al. D33/19
- D. 188,482 8/1960 Litzaw D6/562
- D. 189,722 2/1961 Wolff D6/562
- D. 233,639 11/1974 Wooters D6/91
- D. 241,198 8/1976 Busch et al. D6/570
- D. 266,123 9/1982 Alfano D6/533
- D. 274,201 6/1984 Aaron D6/525
- D. 284,689 7/1986 King et al. D23/304
- D. 286,237 10/1986 Muderlak D6/525
- D. 304,888 12/1989 Korpjaako D6/574

FIG. 2 is a perspective view taken from the bottom and
rear of FIG. 1;

FIG. 3 is a left side elevational view thereof;

FIG. 4 is a top plan view thereof;

FIG. 5 is a bottom plan view thereof;

FIG. 6 is a perspective view taken from the top and
front of a second embodiment thereof;

FIG. 7 is a perspective view taken from the bottom and
rear of FIG. 6;

FIG. 8 is a left side elevational view of FIG. 6;

FIG. 9 is a top plan view of FIG. 6; and,

FIG. 10 is a bottom plan view of FIG. 6.

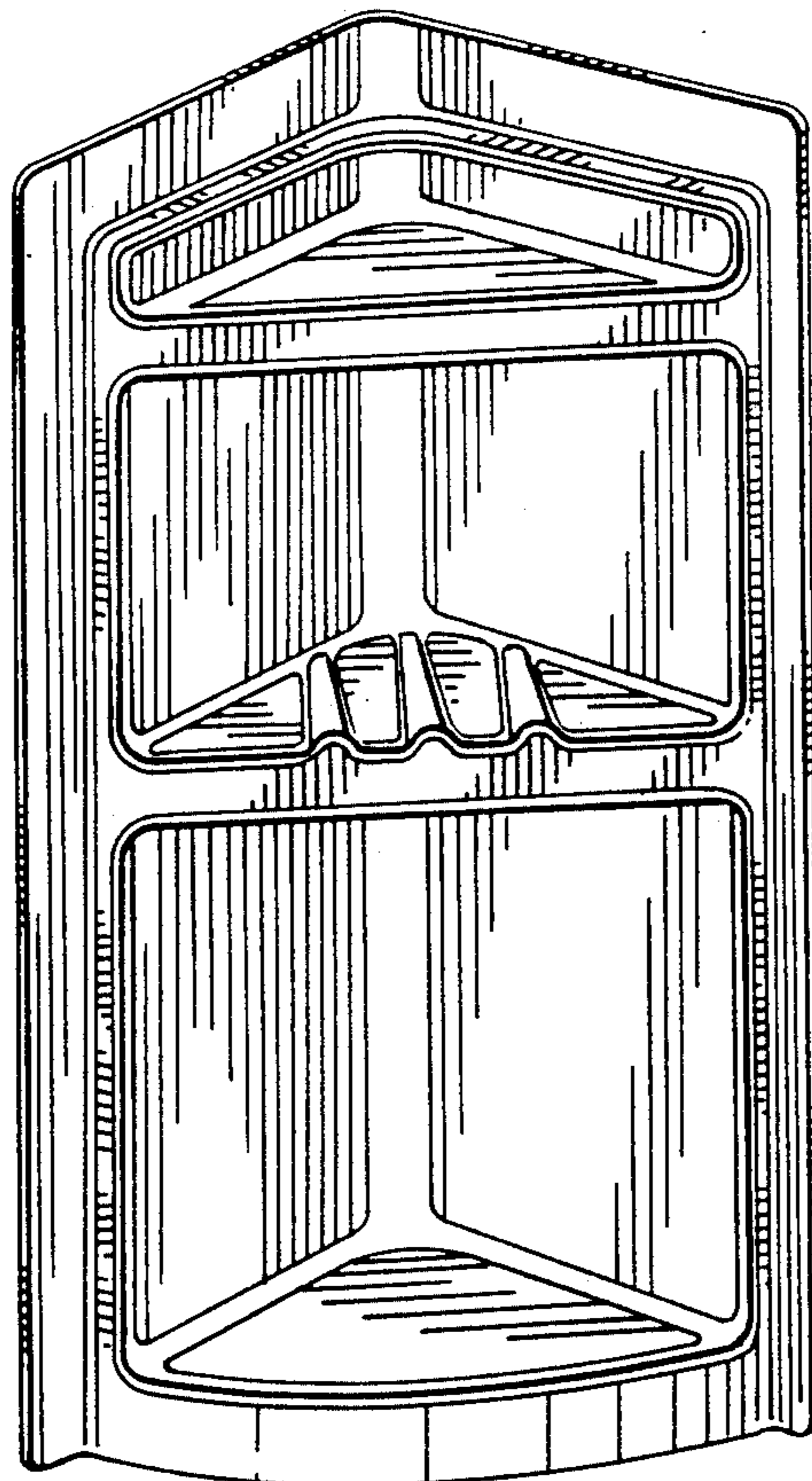

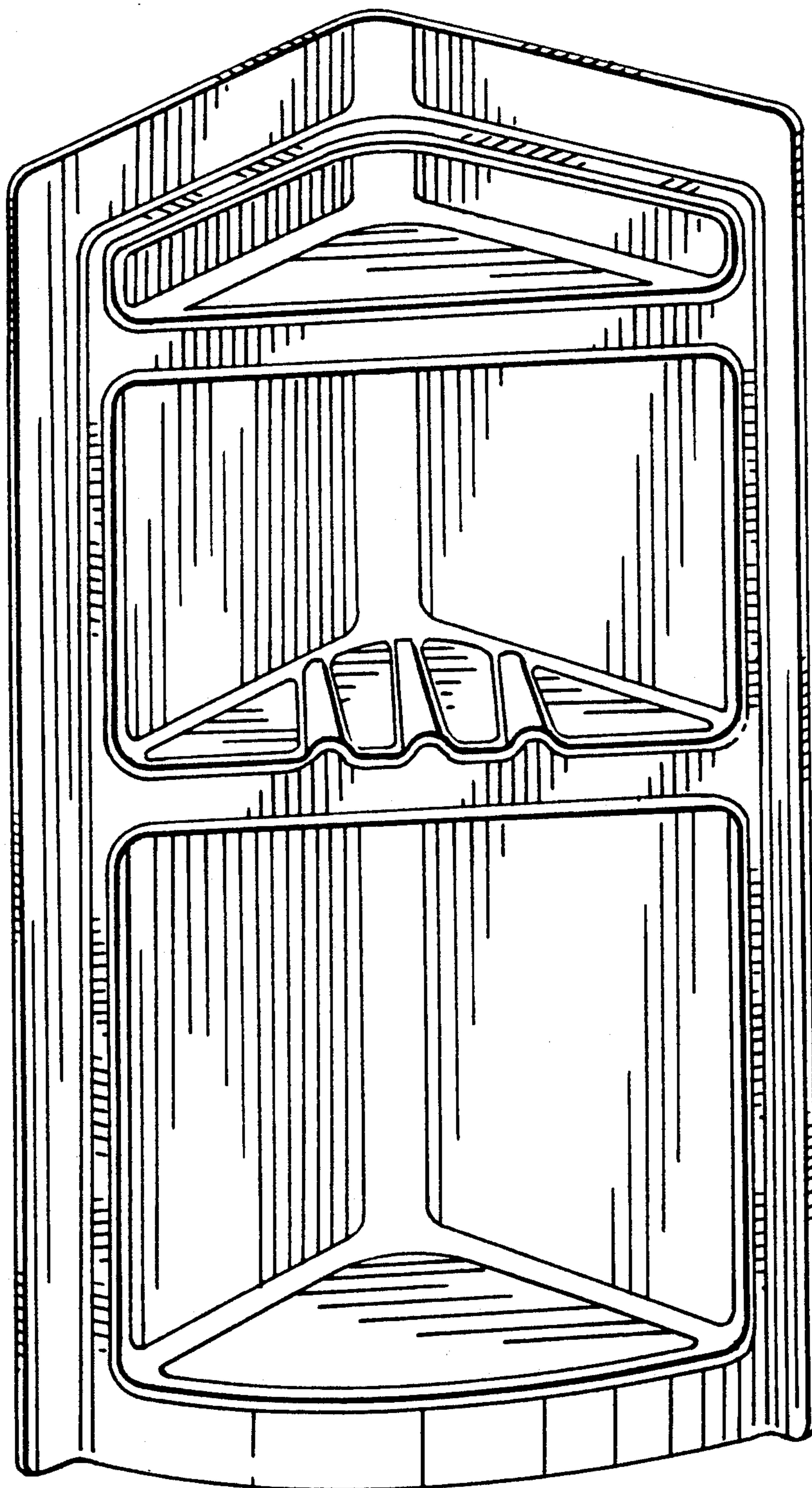

FIG. 1

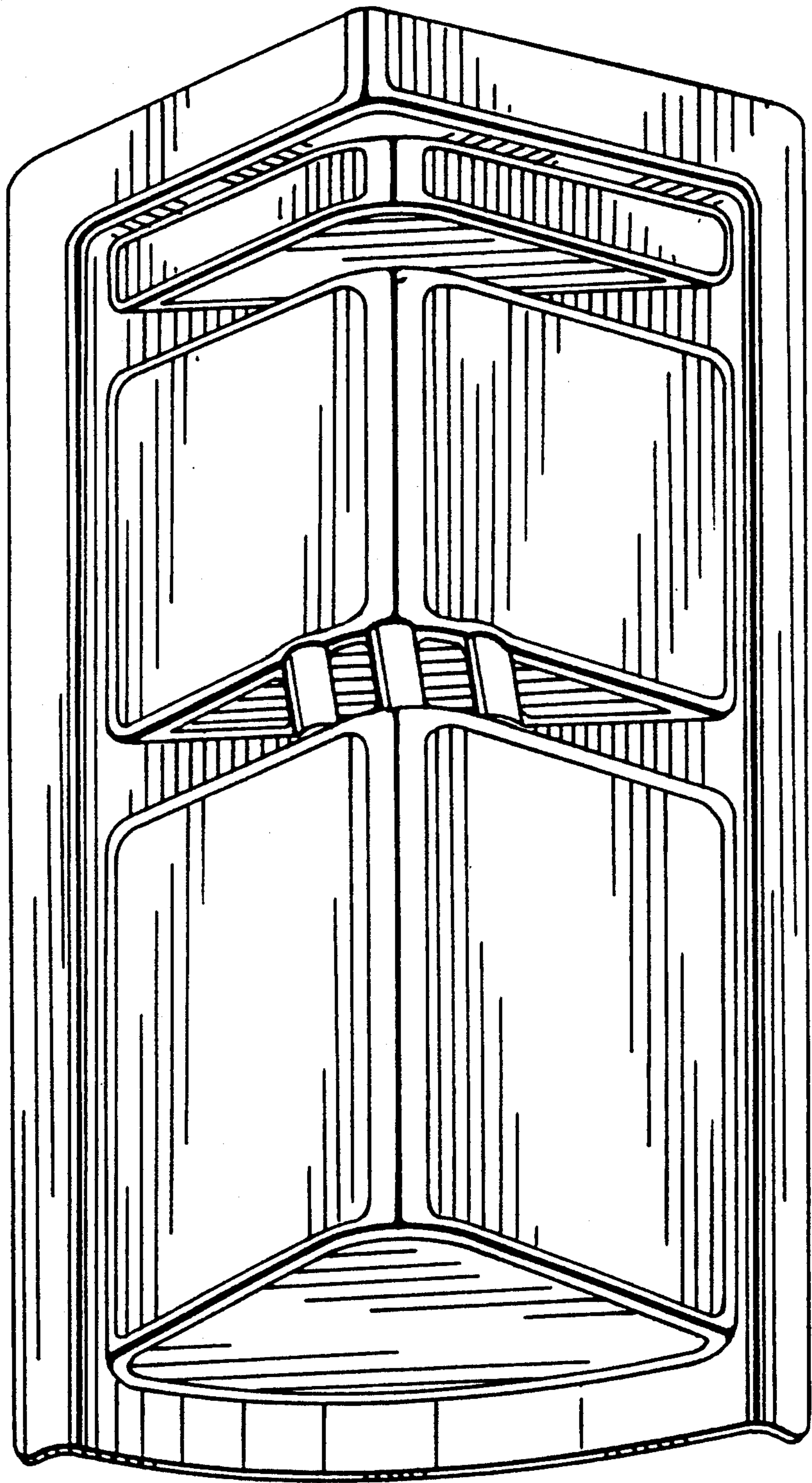

FIG. 2

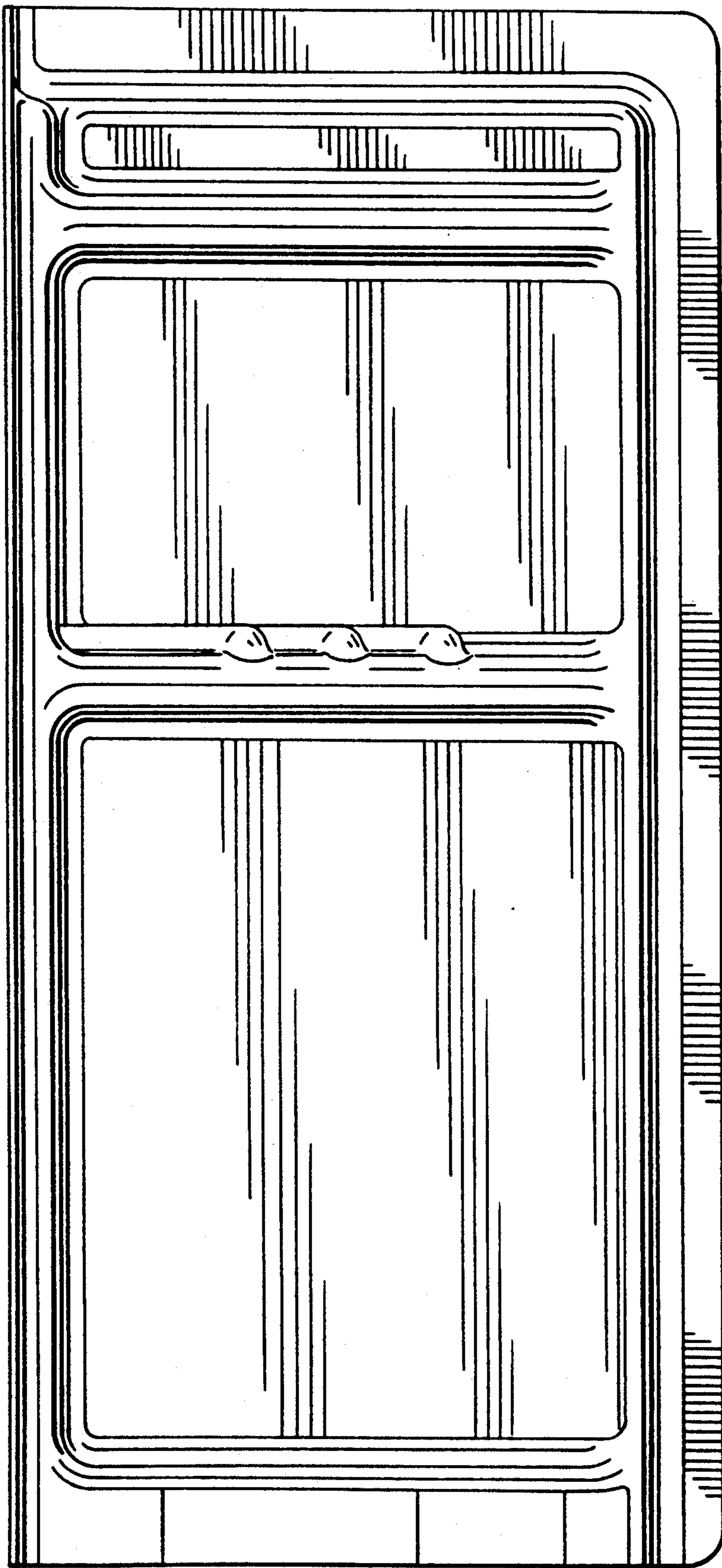

FIG. 3

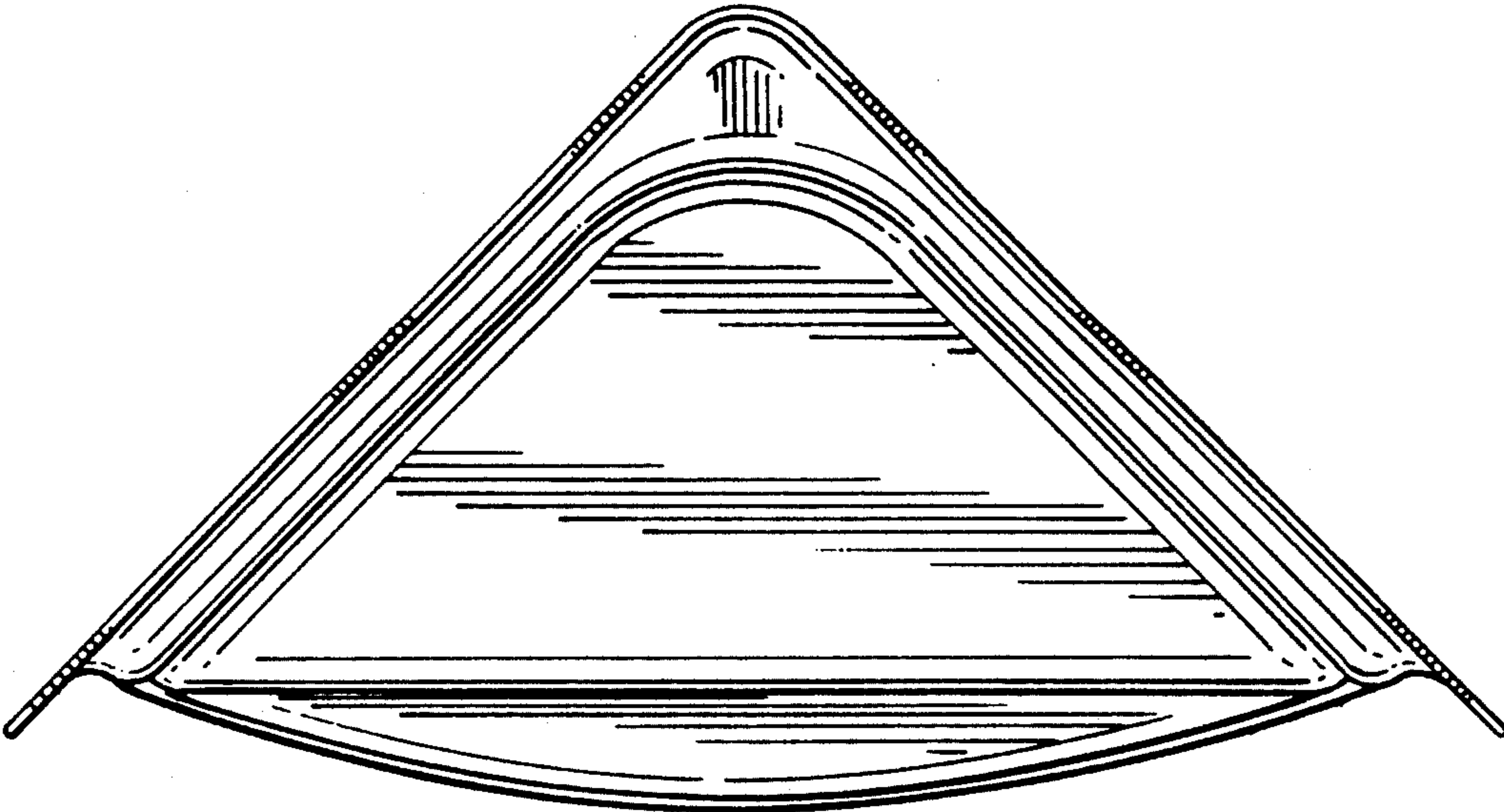

FIG. 4

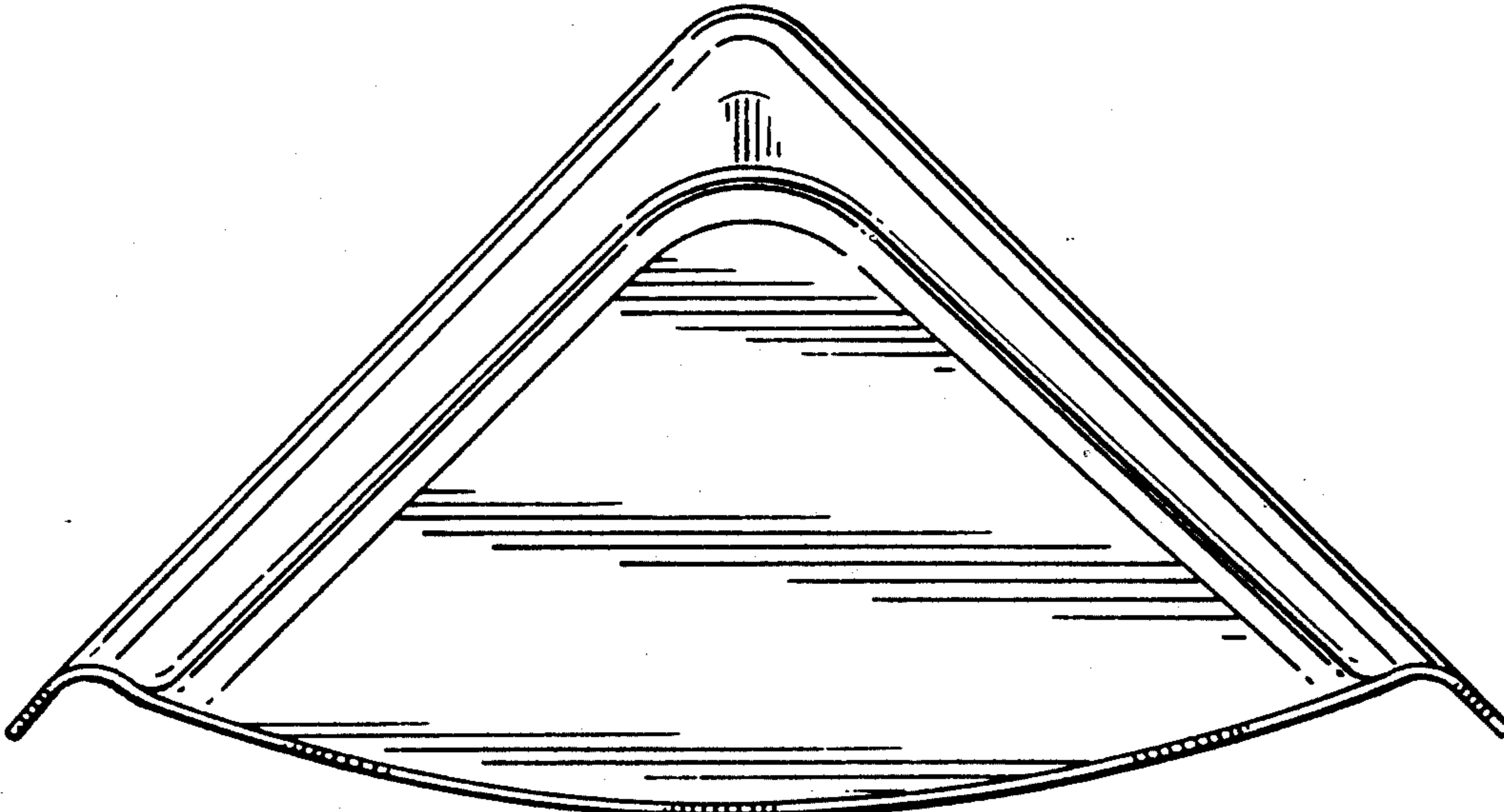

FIG. 5

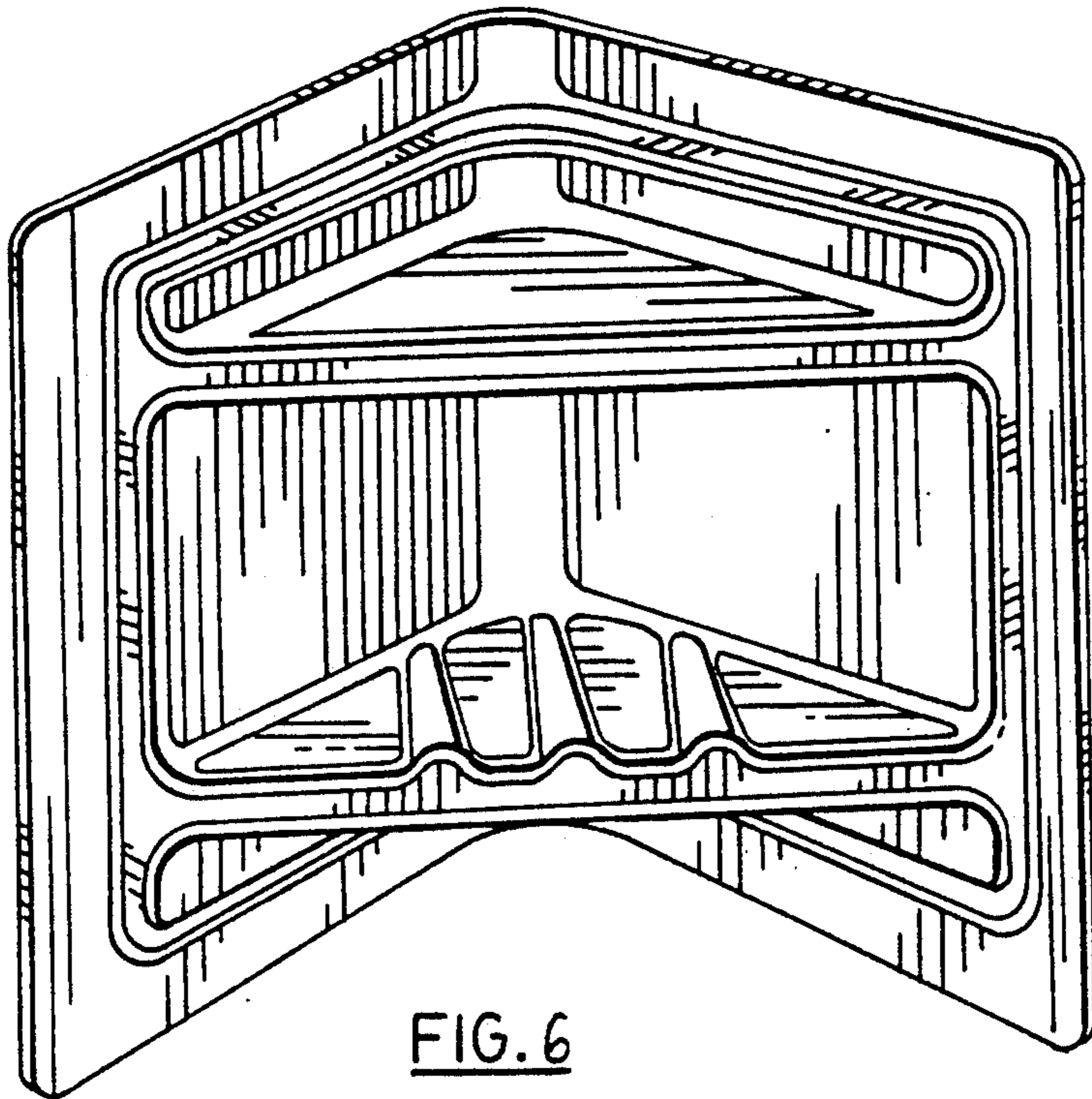

FIG. 6

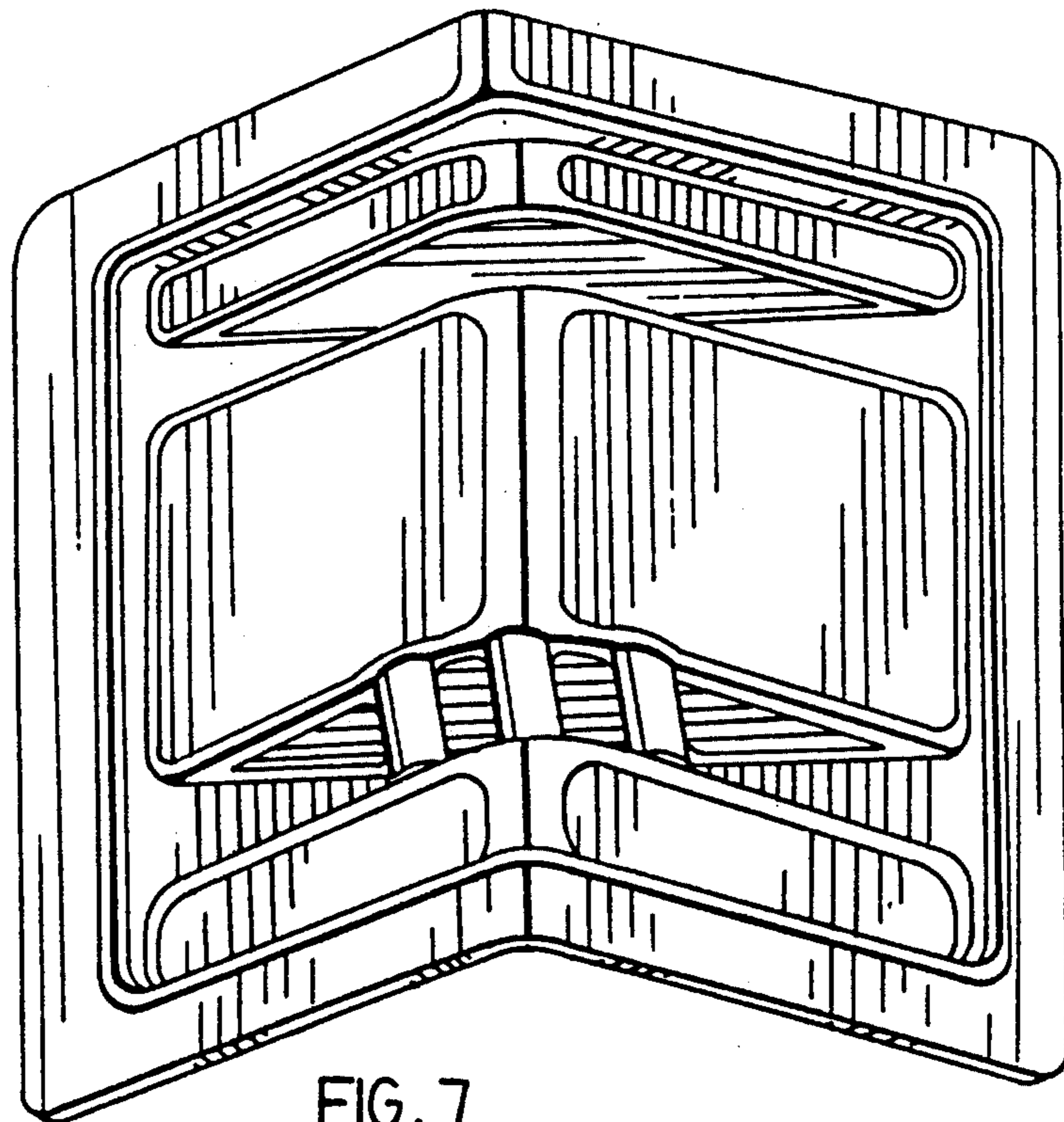

FIG. 7

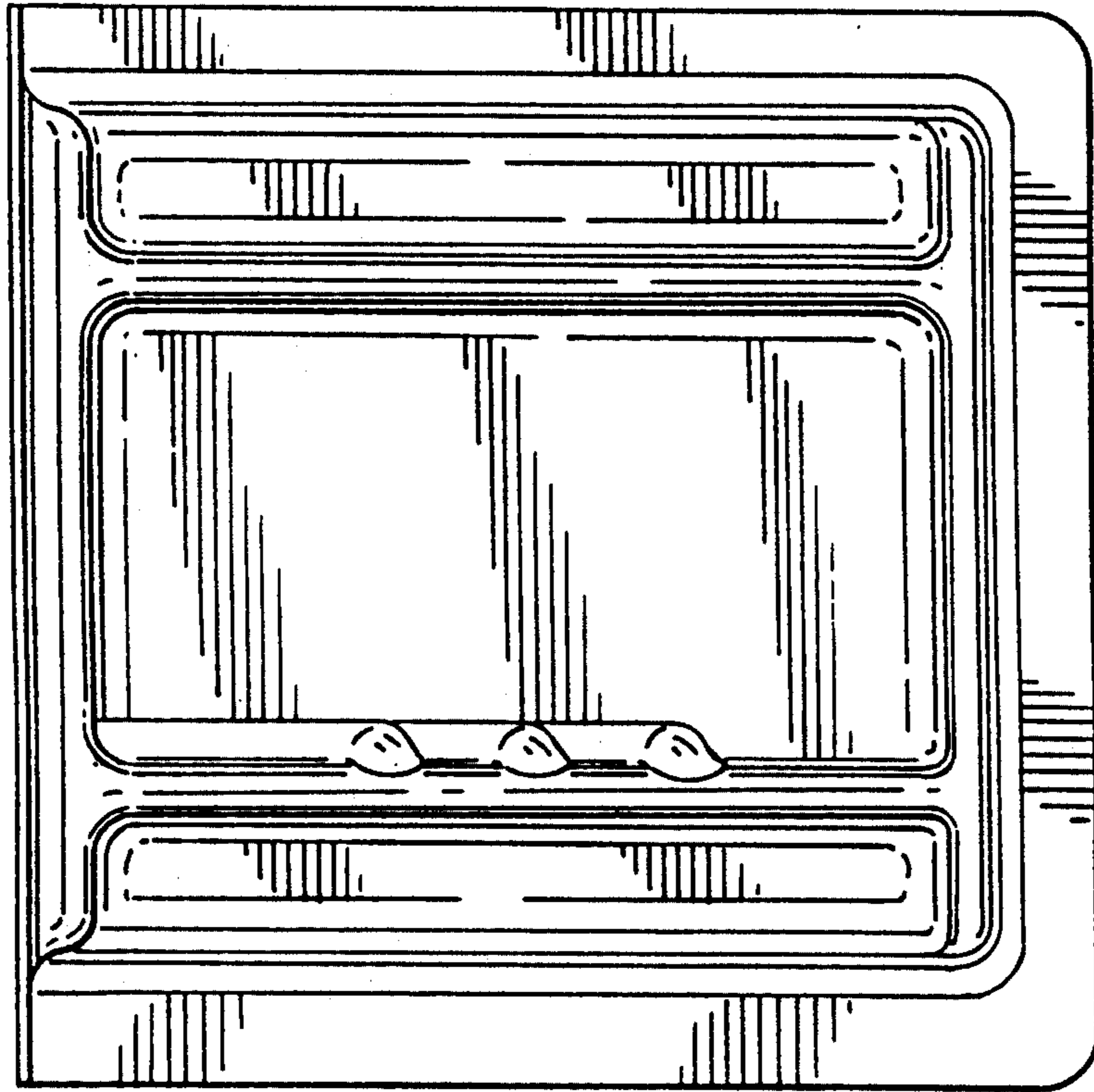

FIG. 8

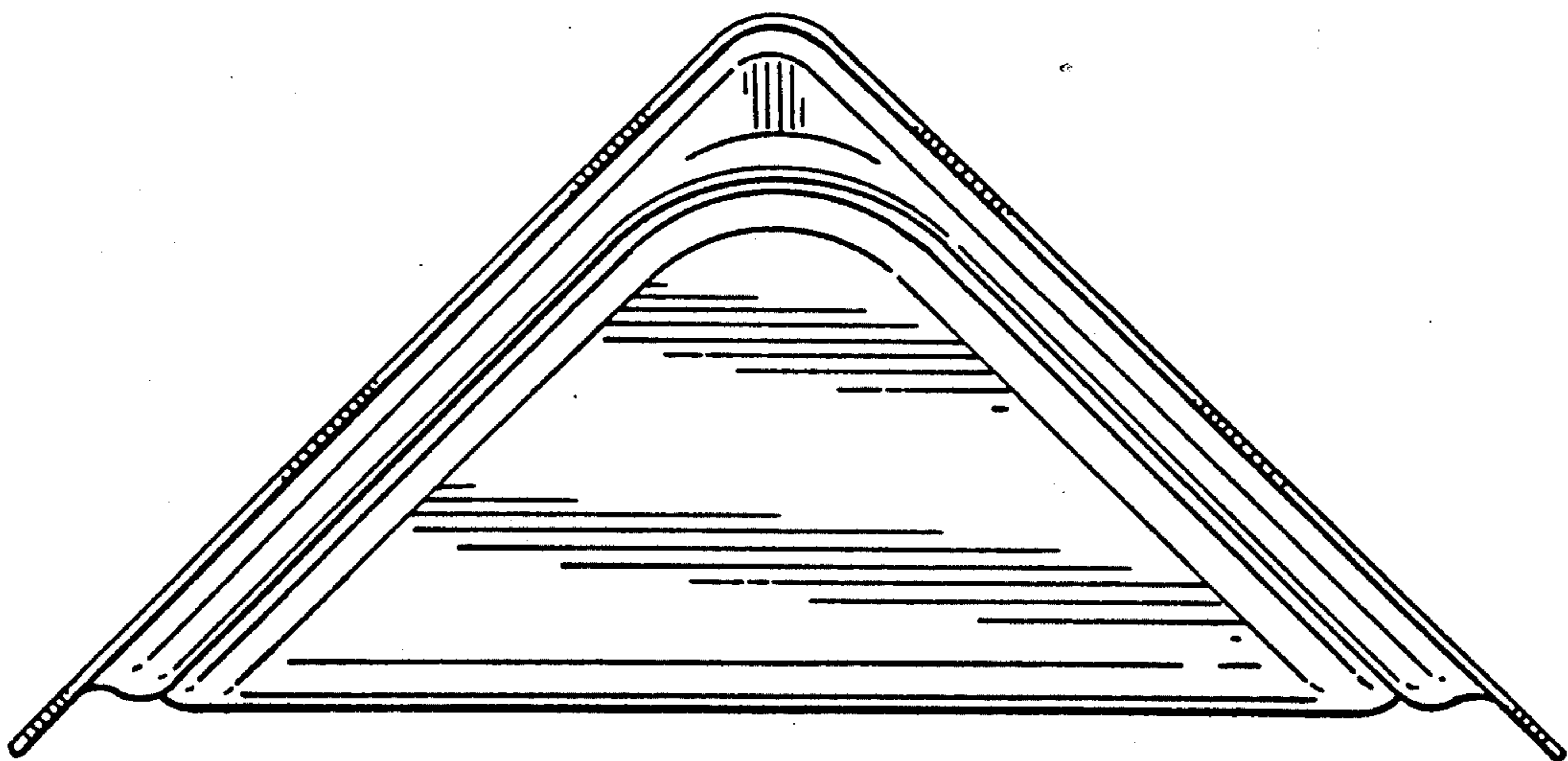

FIG. 9

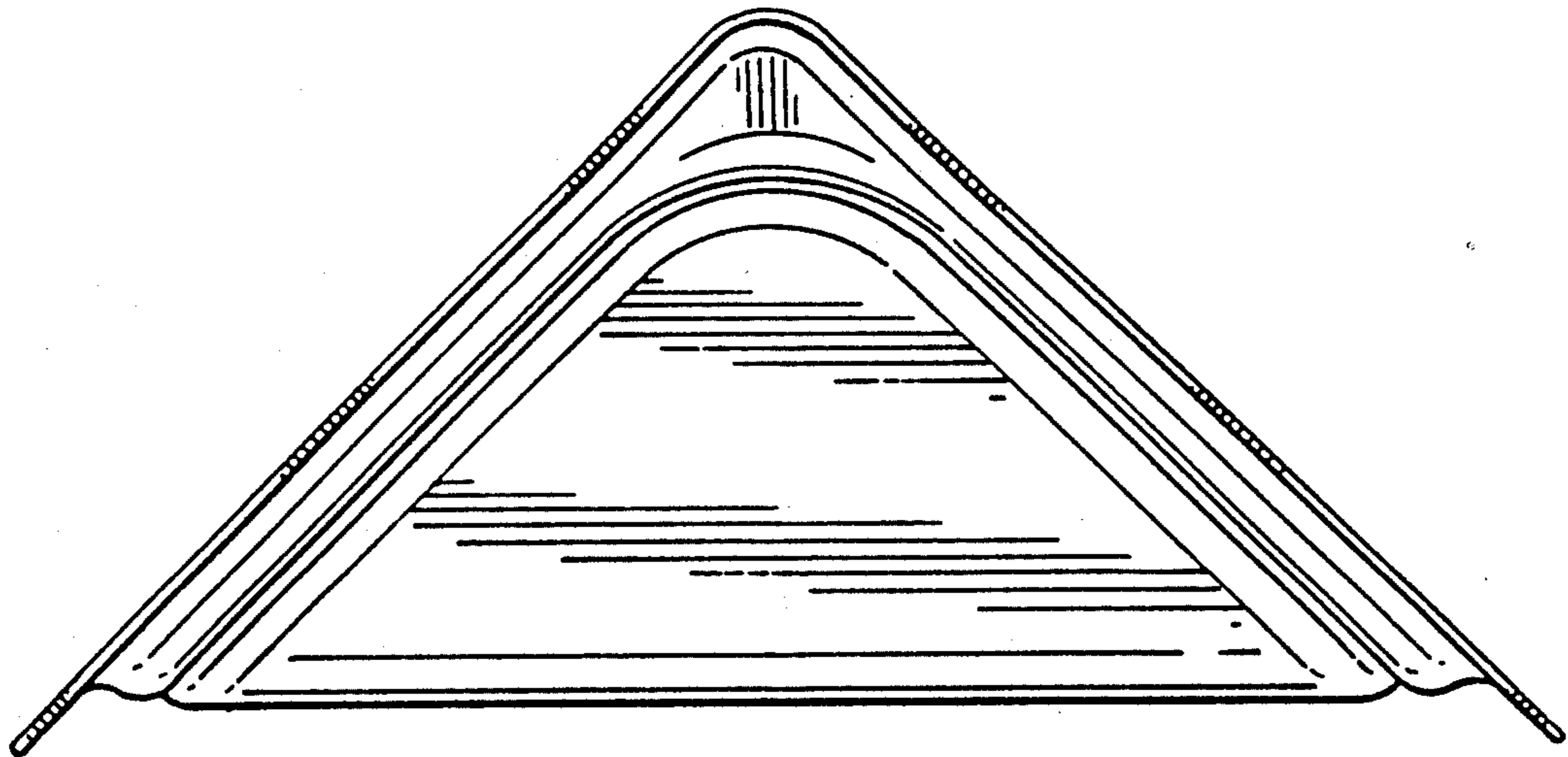

FIG.10