



US00D329146S

# United States Patent [19]

[11] Patent Number: **Des. 329,146**

Neal

[45] Date of Patent: **\*\* Sep. 8, 1992**

## [54] COMBINED CHAIR AND STORAGE UNIT

[76] Inventor: **Kathleen Neal**, 1004 W. Lusher Ave., Elkhart, Ind. 46517

[\*\*] Term: **14 Years**

[21] Appl. No.: **379,905**

[22] Filed: **Jul. 14, 1989**

[52] U.S. Cl. .... **D6/336**

[58] Field of Search ..... **D6/334, 335, 336, 371, D6/500; 297/192, 194**

## FOREIGN PATENT DOCUMENTS

443145 2/1936 United Kingdom ..... 297/194

*Primary Examiner*—Donald P. Walsh  
*Assistant Examiner*—Gary D. Watson  
*Attorney, Agent, or Firm*—Richard C. Litman

## [57] CLAIM

The ornamental design for a combined chair and storage unit, as shown and described.

## DESCRIPTION

FIG. 1 is a left-front perspective view of a combined chair and storage unit showing my new design; FIG. 2 is a front elevational view; FIG. 3 is a rear elevational view; FIG. 4 is a top plan view; FIG. 5 is a bottom plan view; FIG. 6 is a right side elevational view, the left side being a mirror image thereof; and, FIG. 7 is a left-front perspective view showing the storage compartments in opened condition.

## [56] References Cited

### U.S. PATENT DOCUMENTS

D. 104,824	6/1937	Swearingen	.....	D6/334
D. 110,791	8/1938	Armour	.....	D6/336
D. 167,595	8/1952	Simmons	.....	D6/336
D. 222,453	10/1971	Ziss et al.	.....	D6/370 X
811,475	1/1906	Bradley	.....	297/192
2,217,426	10/1940	Zareko	.....	297/192
2,494,838	1/1950	Slaughter	.....	297/194
2,703,600	3/1955	Harper	.....	297/194

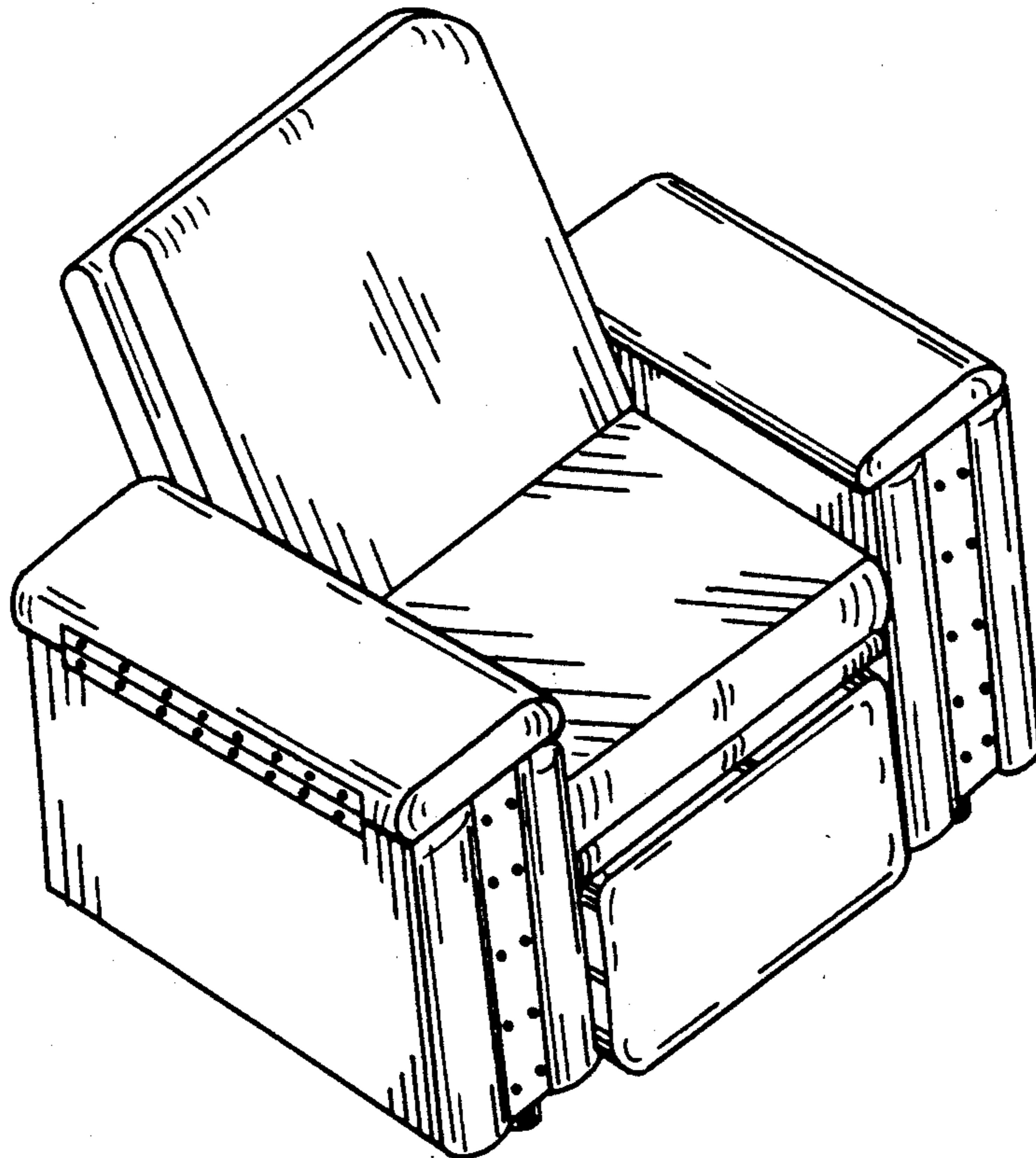

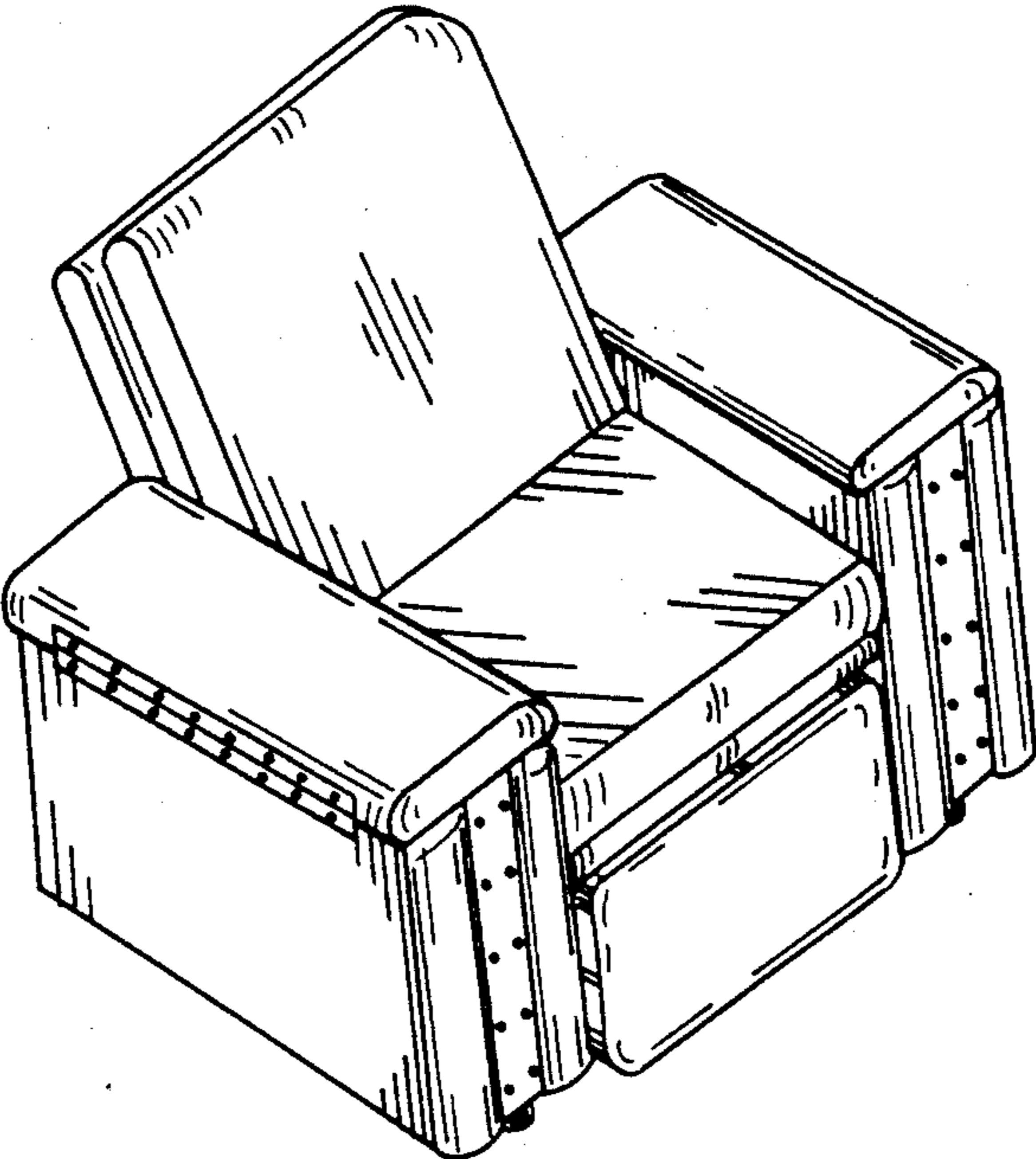

FIG. 1

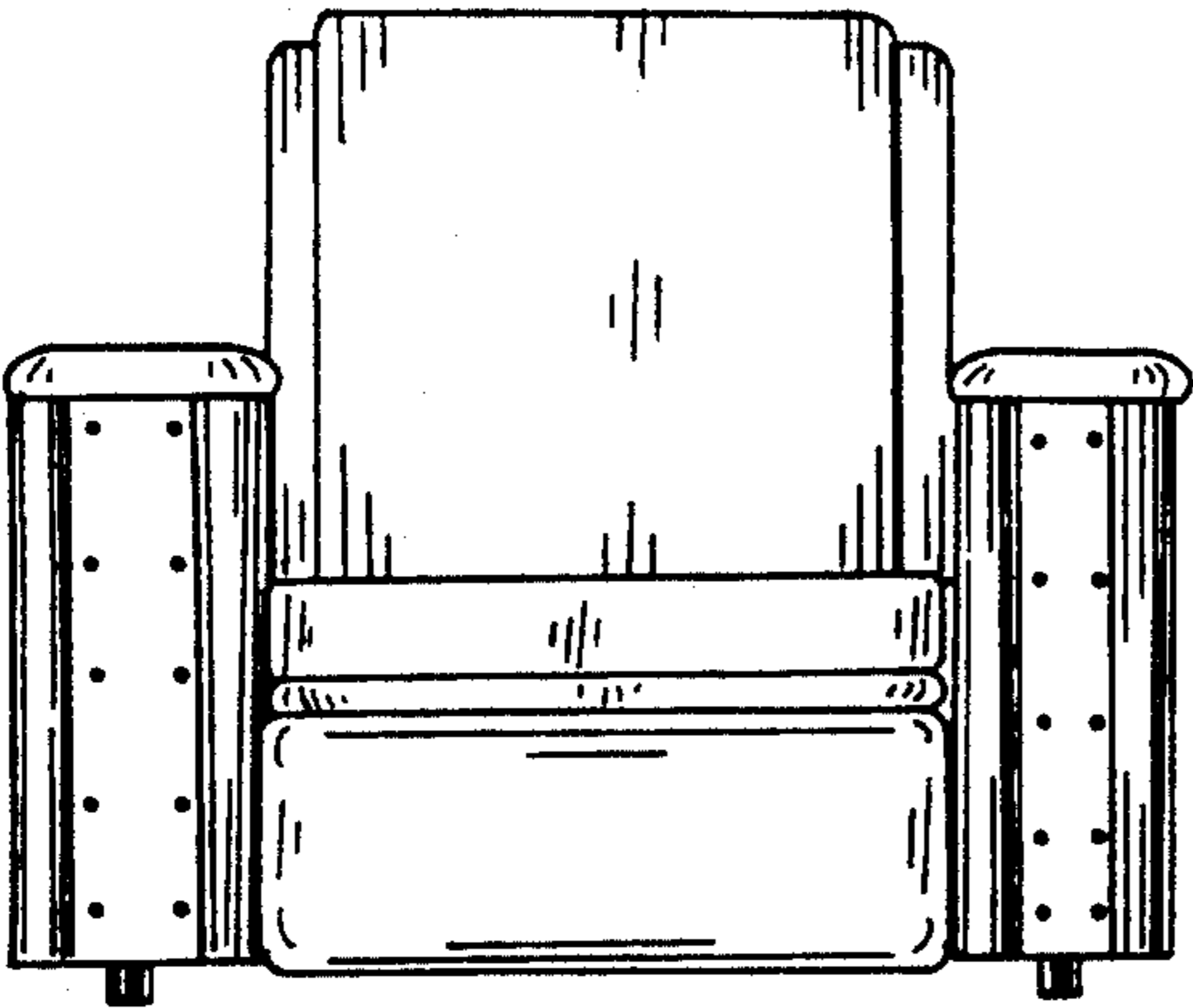

FIG. 2

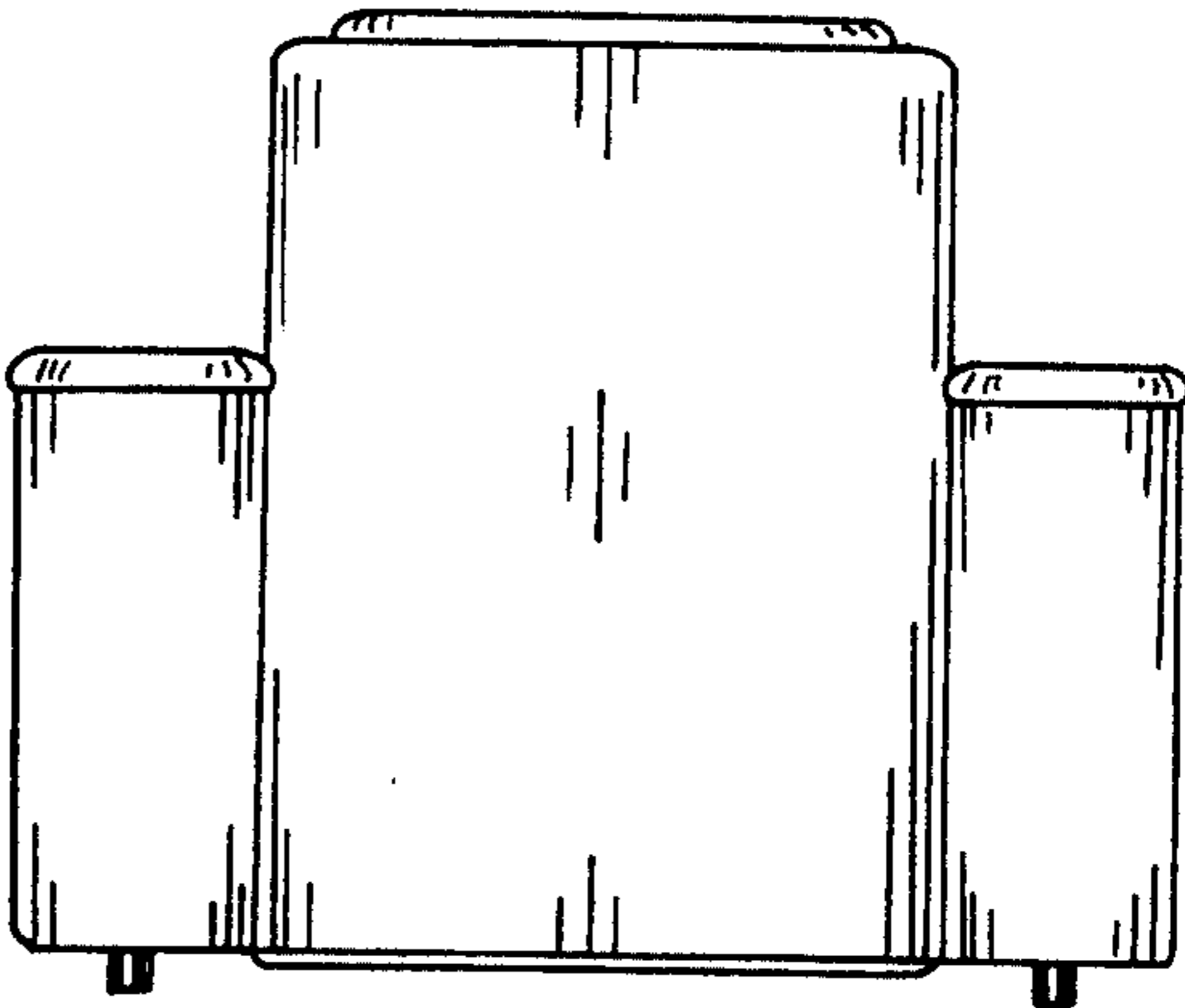

FIG. 3

FIG. 4

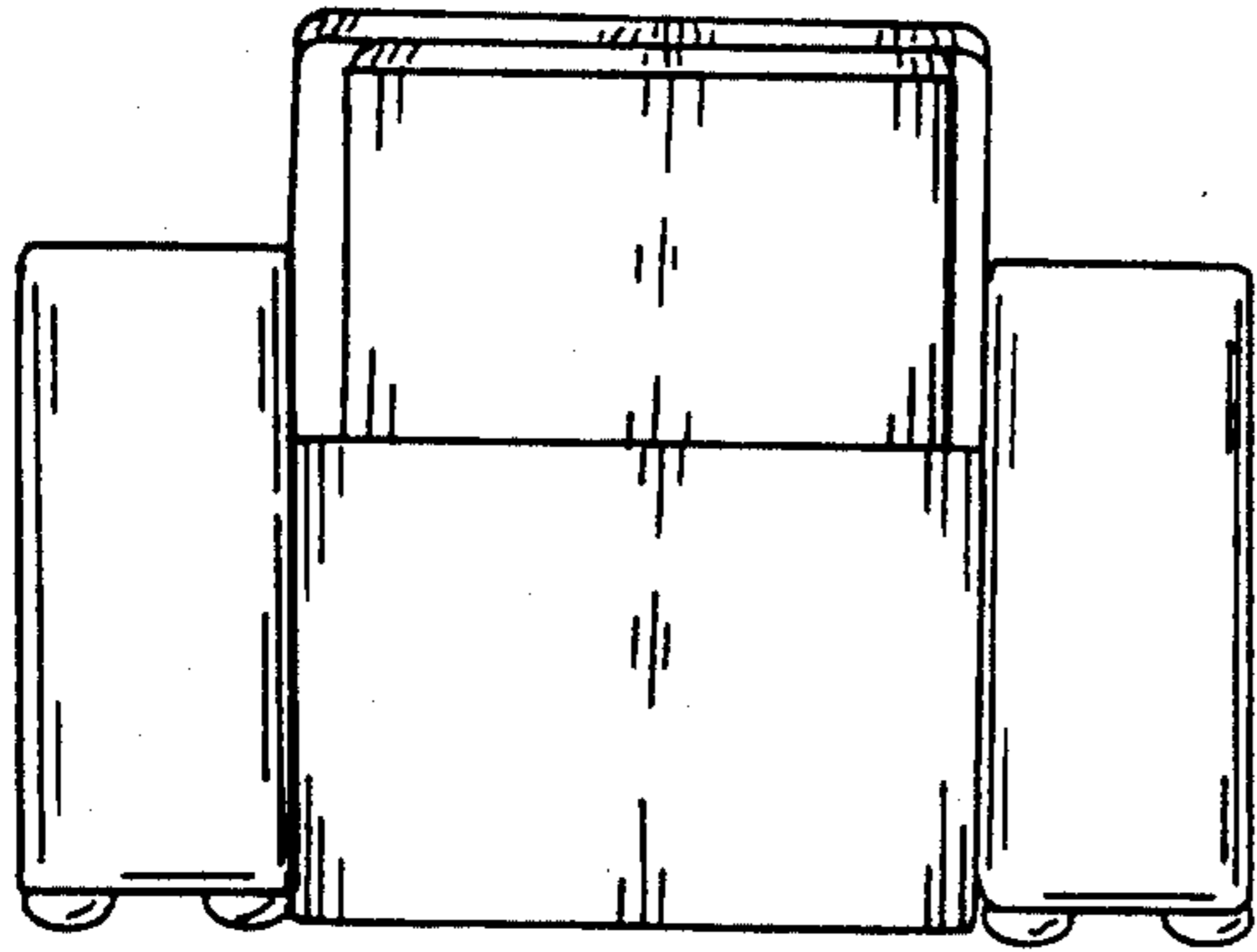

FIG. 5

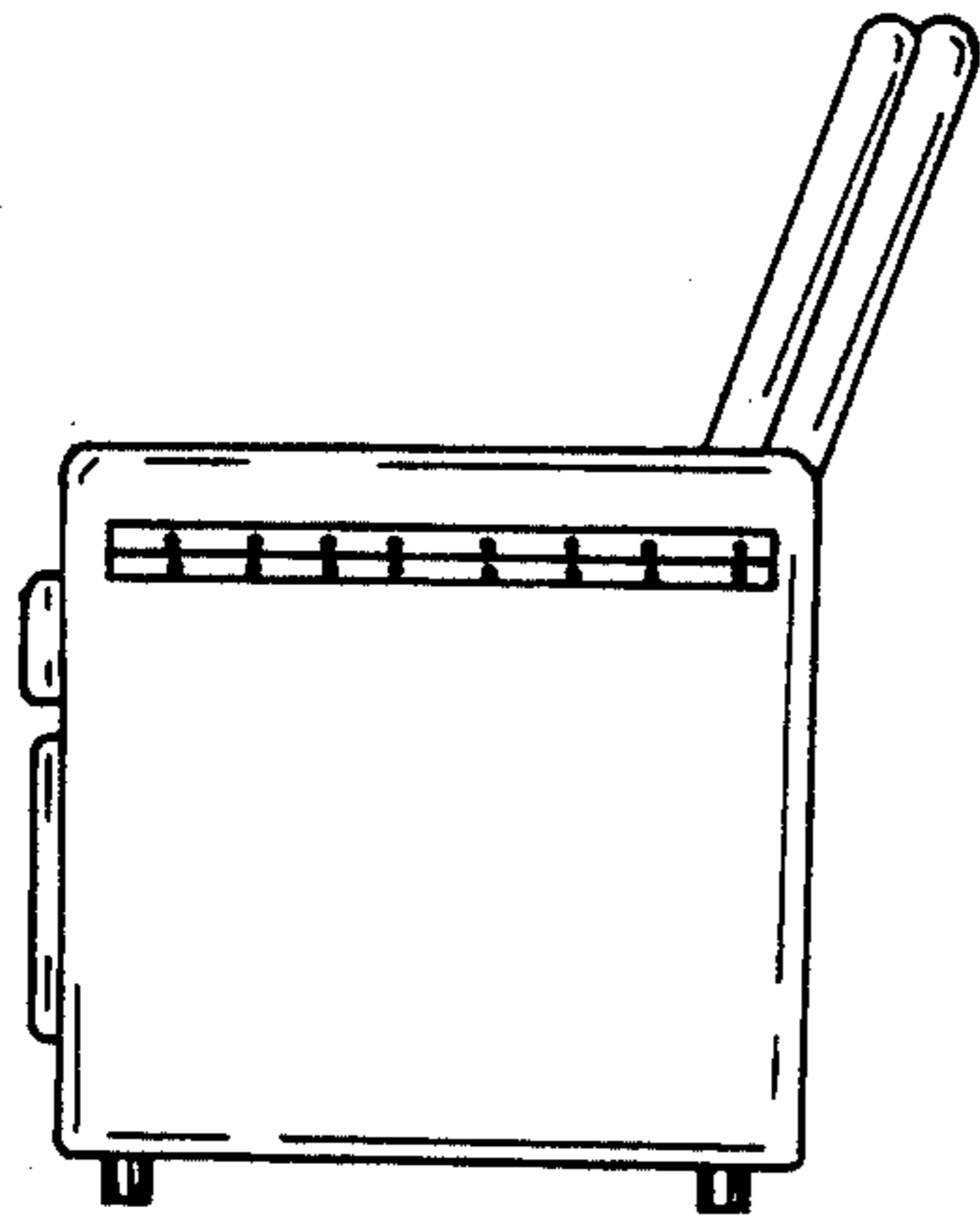
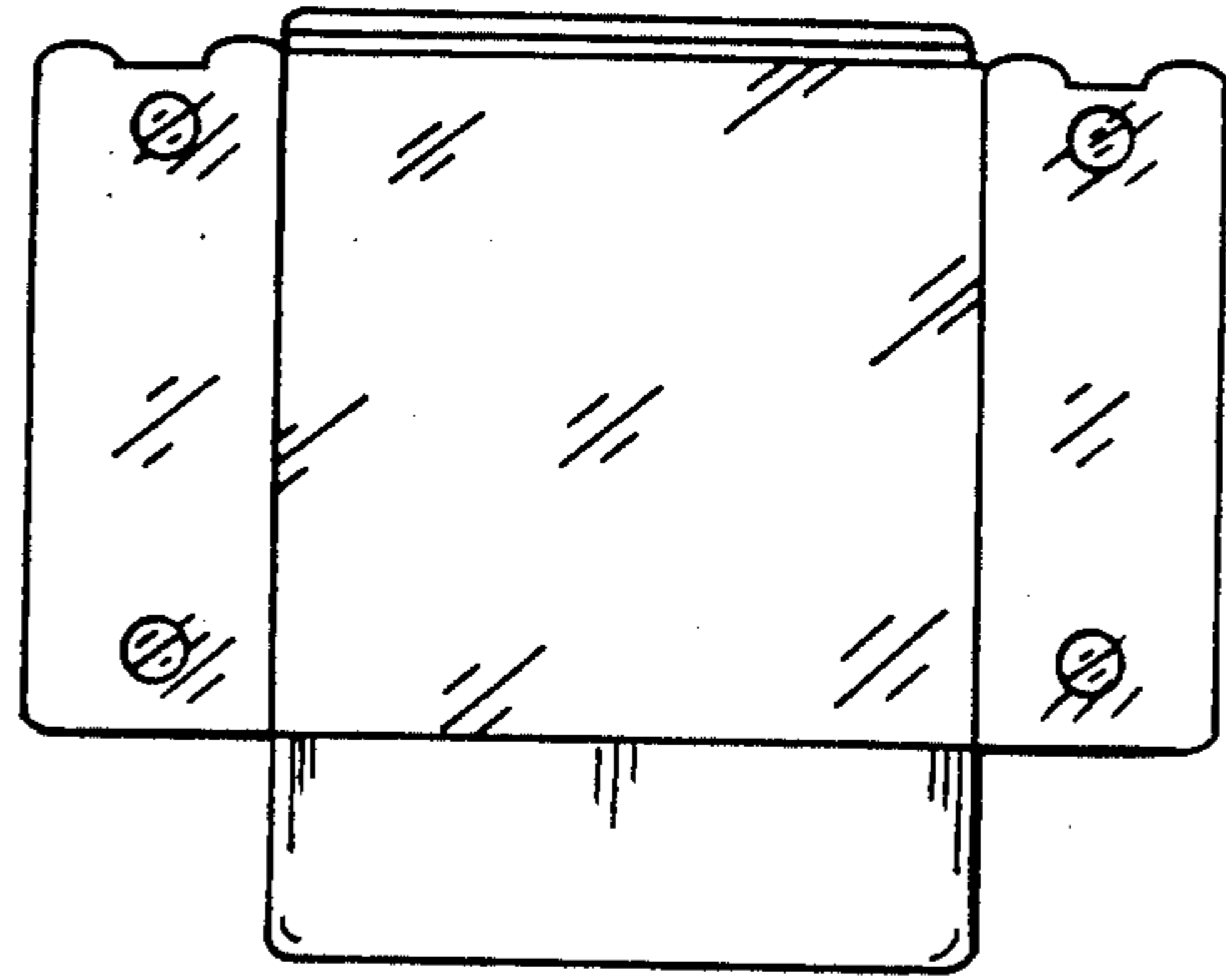

FIG. 6

FIG. 7

