



US00D329111S

United States Patent [19]

[11] Patent Number: **Des. 329,111**

Urquidi et al.

[45] Date of Patent: **** Sep. 1, 1992**

[54] TRASH RECEPTICLE

666,880	1/1901	Zerrahn	D34/6
957,237	5/1910	Moorman	248/134
1,227,323	5/1917	Russell	248/137

[76] Inventors: **Viterbo Urquidi**, 9185 Coventry Rd.;
Felipe P. Urquidi, 9223 Alameda Ave., both of, El Paso, Tex. 79907

Primary Examiner—Kay H. Chin
Attorney, Agent, or Firm—Leon Gildeen

[**] Term: **14 Years**

[57] **CLAIM**

[21] Appl. No.: **599,375**

The ornamental design for a trash receptacle, as shown and described.

[22] Filed: **Oct. 18, 1990**

[52] U.S. Cl. **D34/7; D34/1; D34/6**

DESCRIPTION

[58] Field of Search **D34/1, 5, 6; 248/134, 248/137; 220/908, 909, 910**

FIG. 1 is a front elevational view of the trash receptacle showing my new design;
FIG. 2 is a rear elevational view thereof;
FIG. 3 is a left side elevational view thereof;
FIG. 4 is a right side elevational view thereof;
FIG. 5 is a top plan view thereof;
FIG. 6 is a bottom plan view thereof; and,
FIG. 7 is a top perspective view thereof.

[56] **References Cited**

U.S. PATENT DOCUMENTS

D. 319,520 8/1991 Yurk et al. D34/6

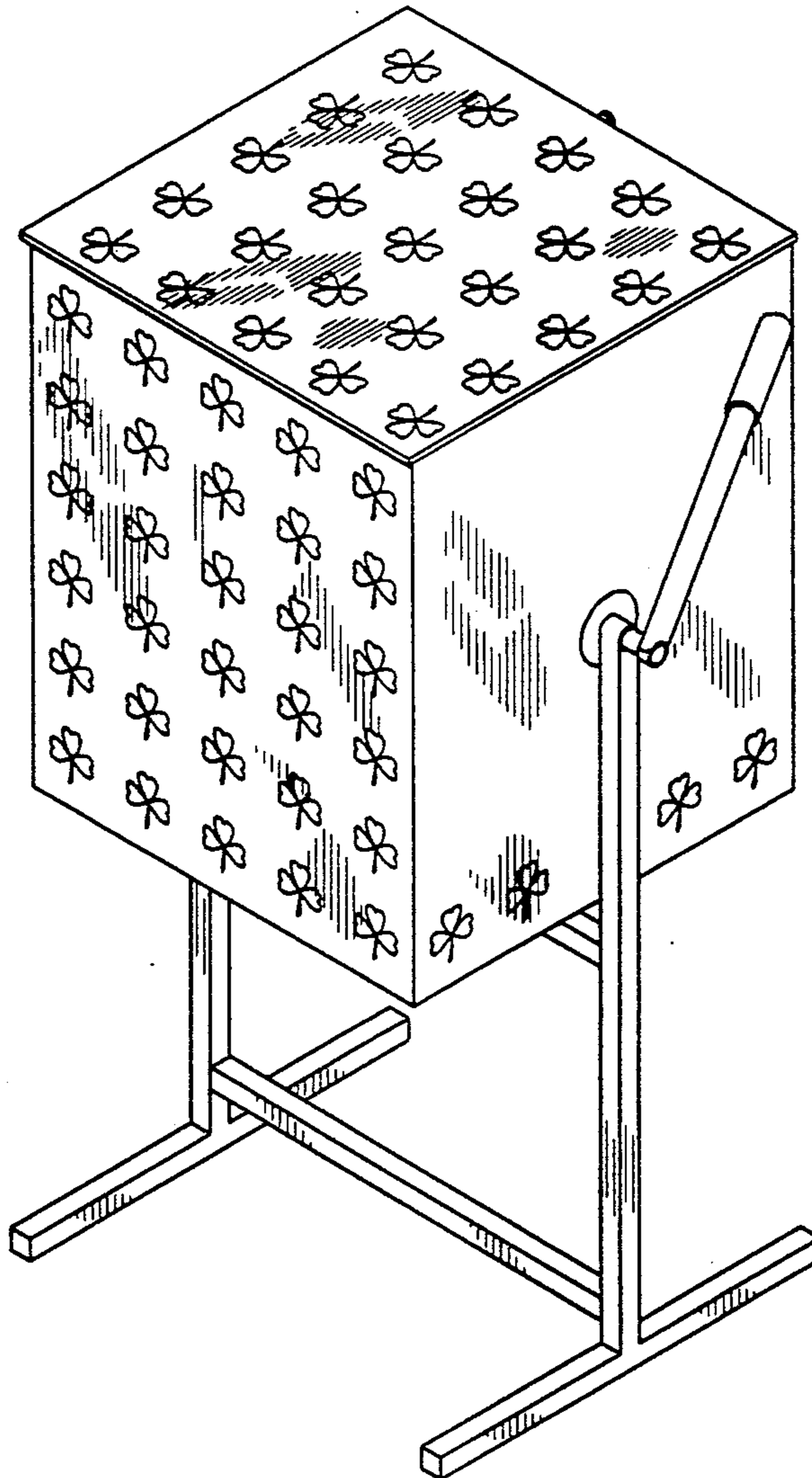

FIG. 1

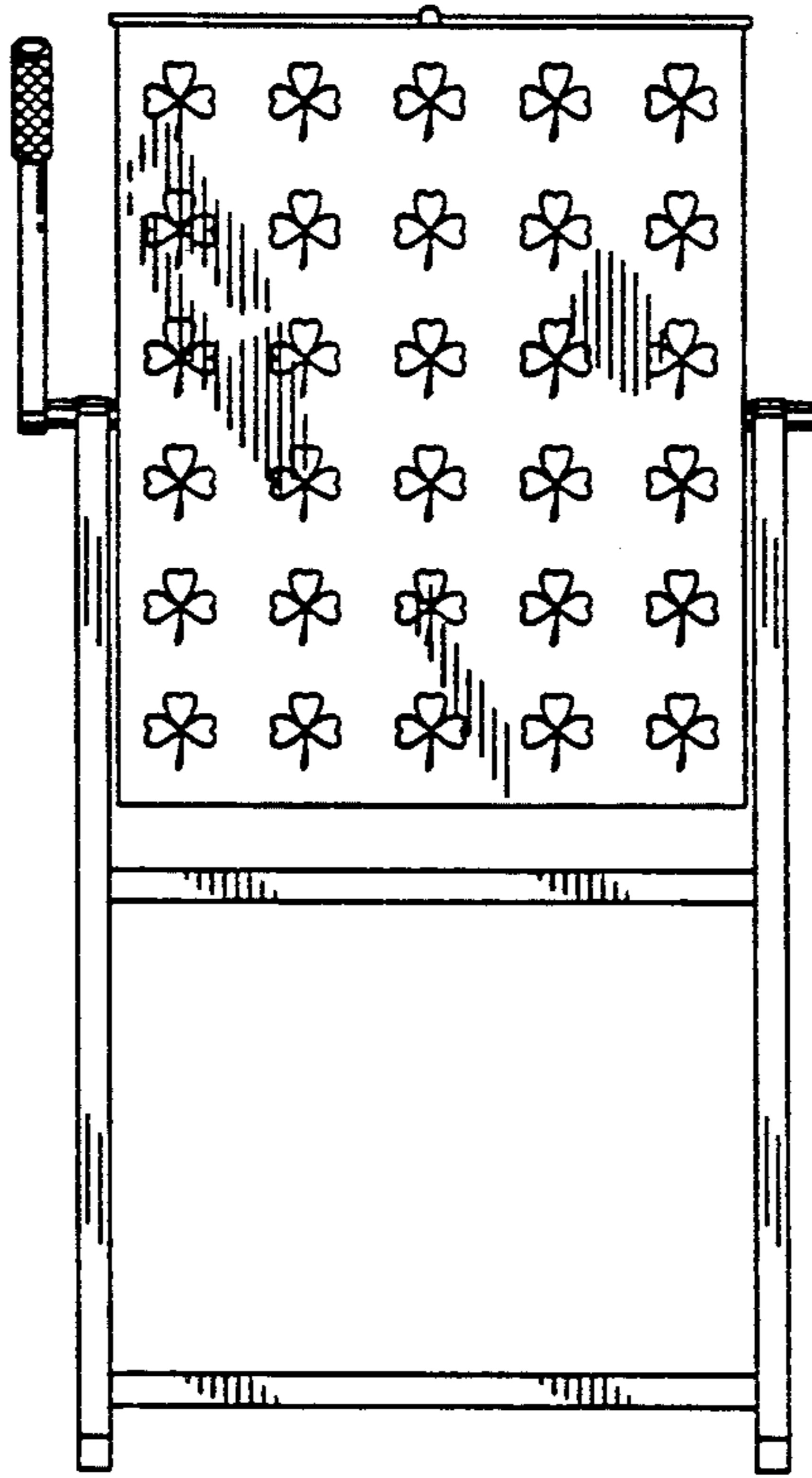

FIG. 2

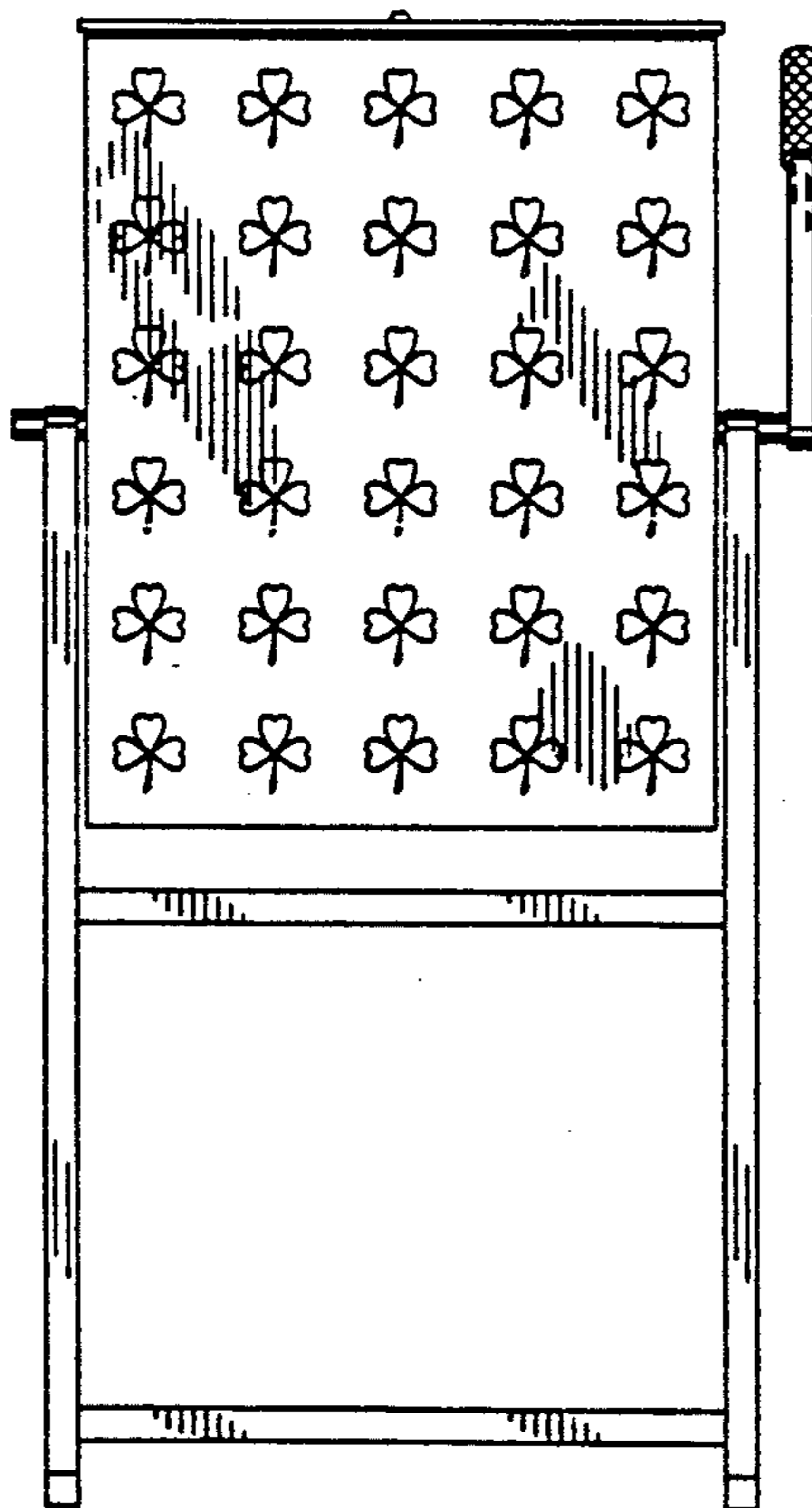

FIG. 3

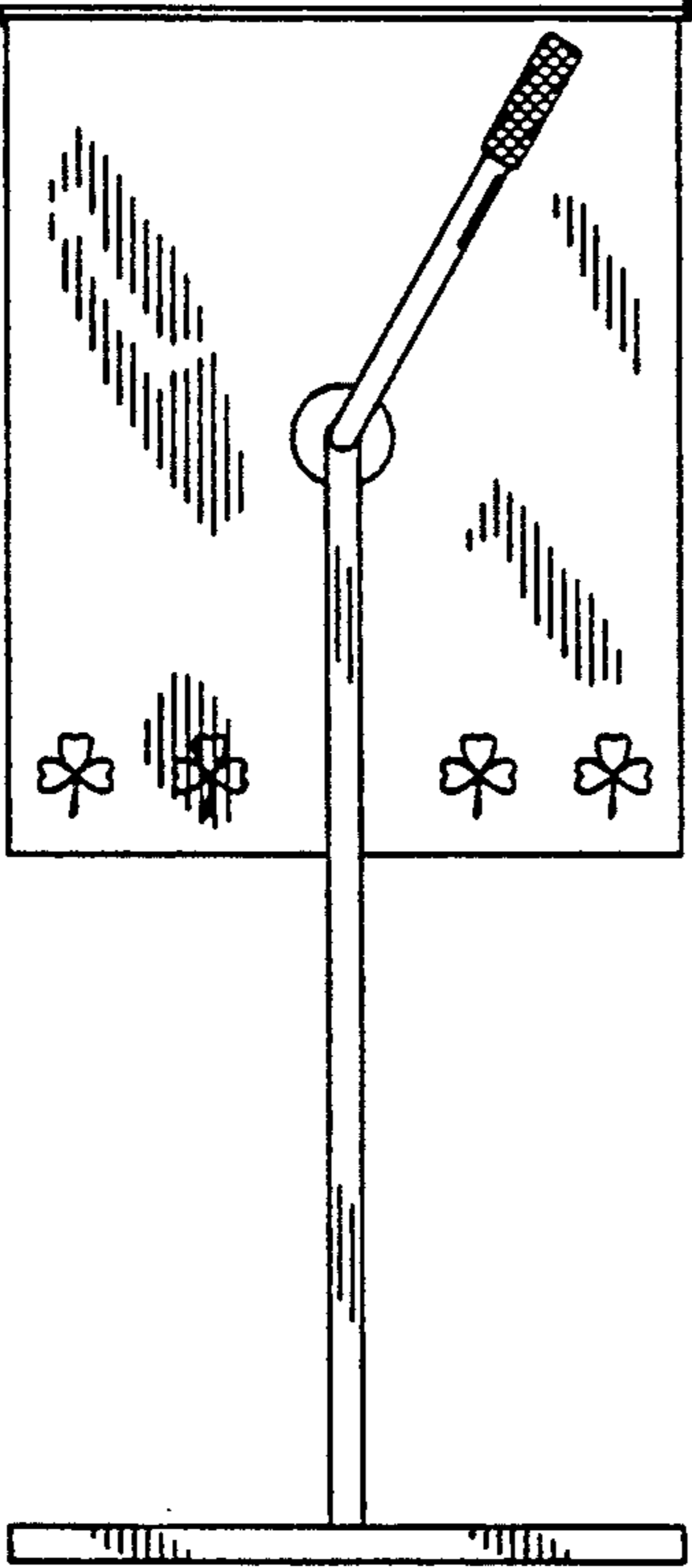

FIG. 4

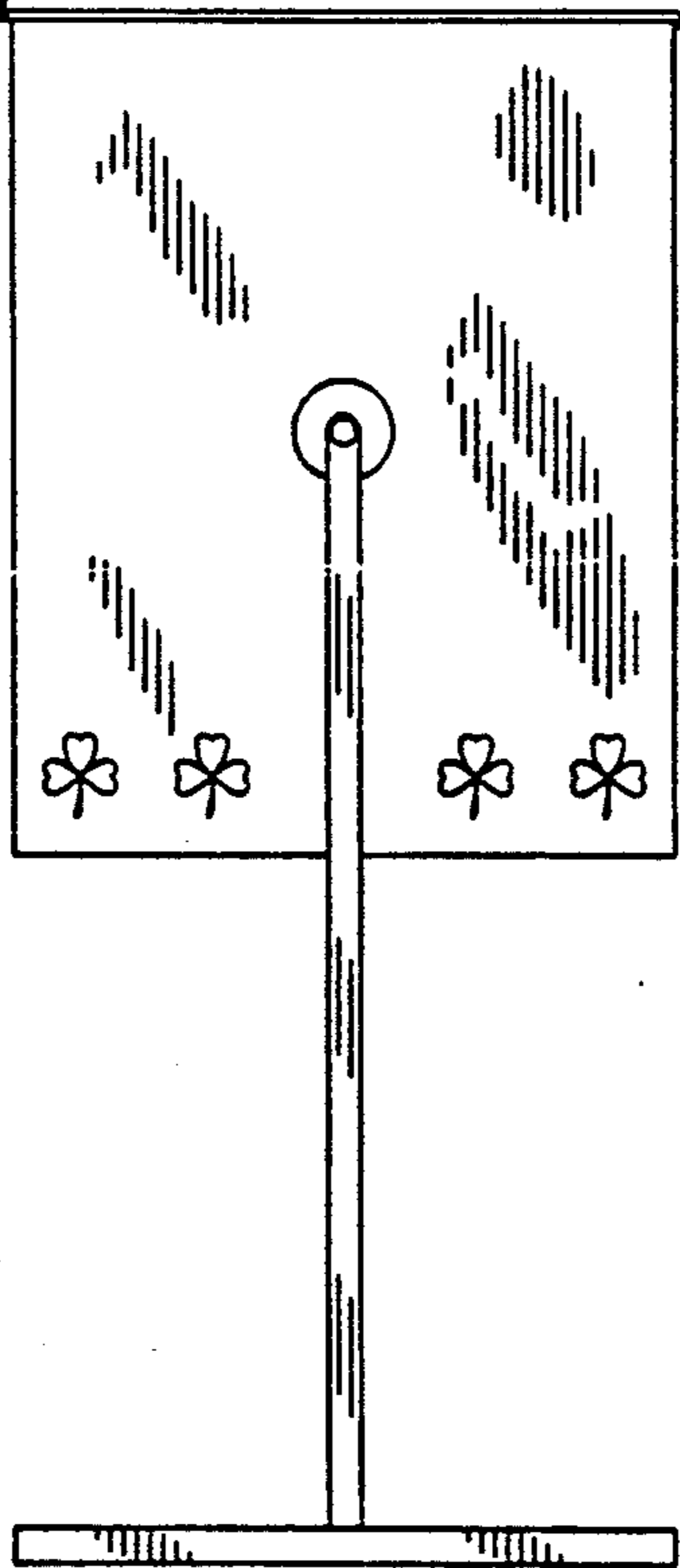

FIG. 5

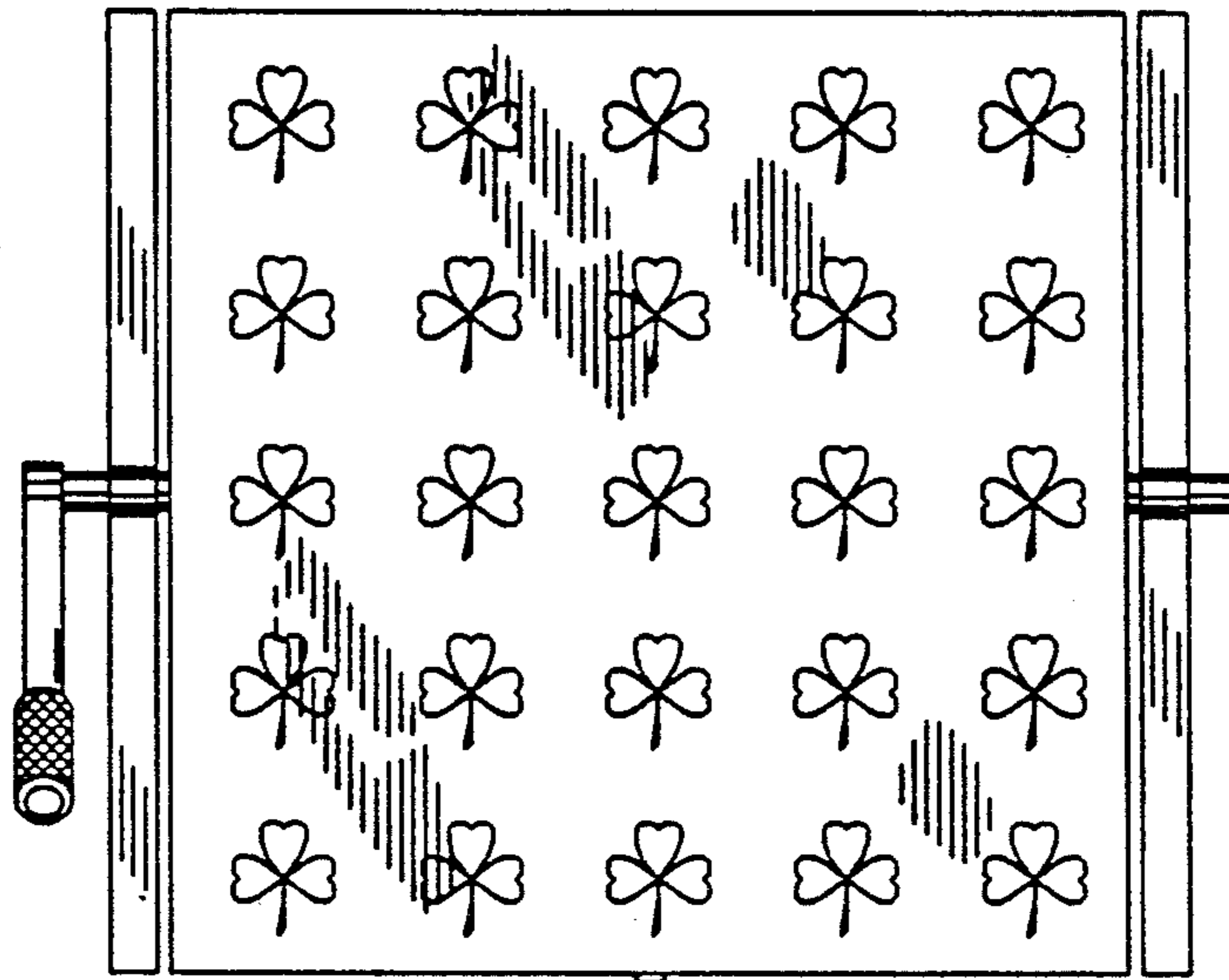

FIG. 6

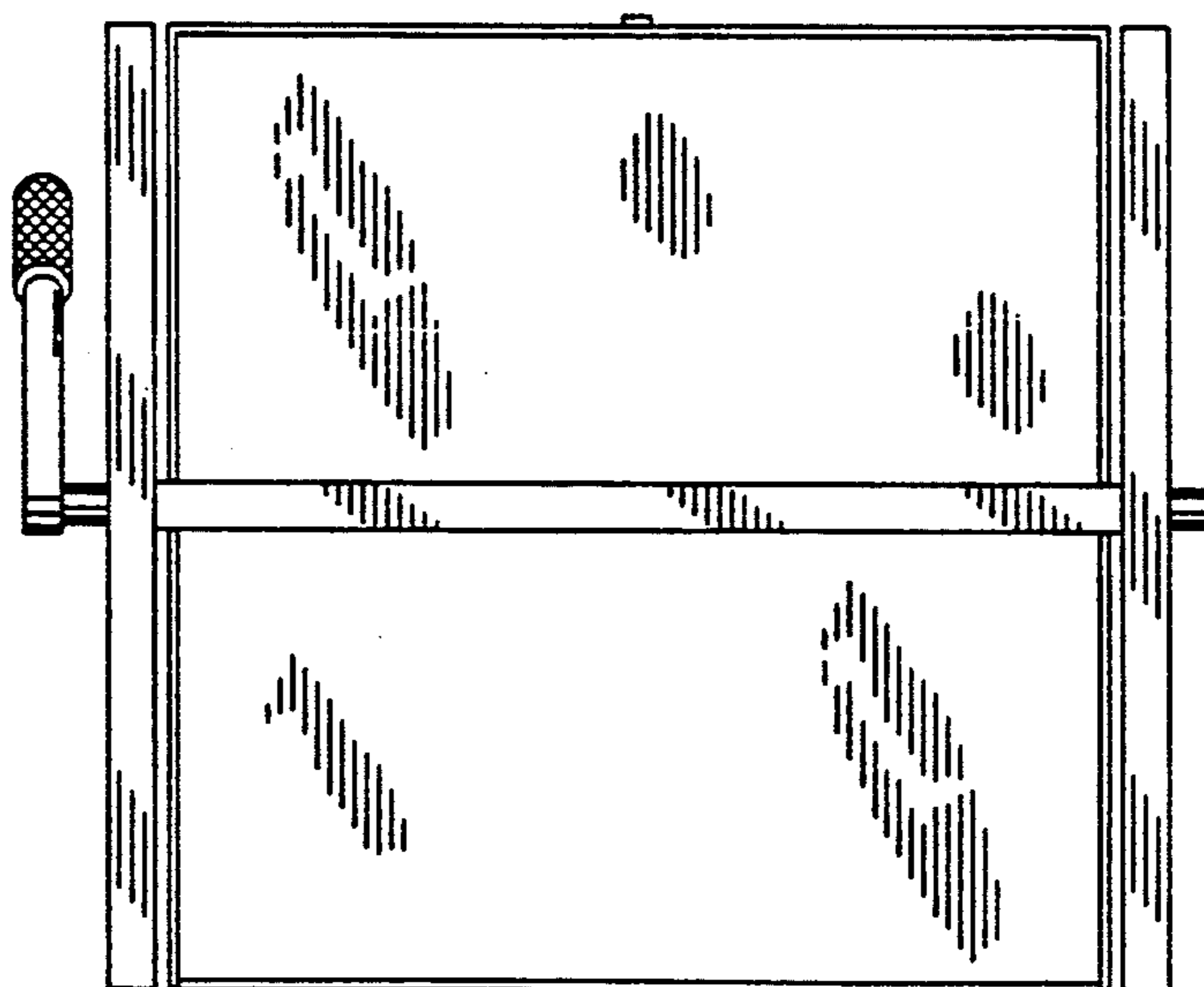

FIG. 7

