



US00D329001S

United States Patent [19]

[11] Patent Number: **Des. 329,001**

Valentino

[45] Date of Patent: **** Sep. 1, 1992**

[54] COOLER

4,700,395 10/1987 Long 62/457.7 X

[76] Inventor: **Giuseppe Valentino, 1392 Little Neck Ave., Bellmore, N.Y. 11710**

*Primary Examiner—Terry A. Pfeffer
Attorney, Agent, or Firm—Leon Gilden*

[**] Term: **14 Years**

[57] CLAIM

[21] Appl. No.: **558,381**

The ornamental design for a cooler, as shown and described.

[22] Filed: **Jul. 27, 1990**

DESCRIPTION

[52] U.S. Cl. **D7/605**

[58] Field of Search **D7/605-608;
62/457.1, 457.7; 220/410, 412**

FIG. 1 is a front elevational view of the cooler showing my new design;

FIG. 2 is a rear elevational view thereof;

FIG. 3 is a left side elevational view thereof;

FIG. 4 is a right side elevational view thereof;

FIG. 5 is a top plan view thereof;

FIG. 6 is a bottom plan view thereof; and,

FIG. 7 is a perspective view thereof in an open position.

[56] References Cited

U.S. PATENT DOCUMENTS

- D. 253,537 11/1979 Seager D7/605 X
- D. 259,760 7/1981 Lucas et al. D7/605

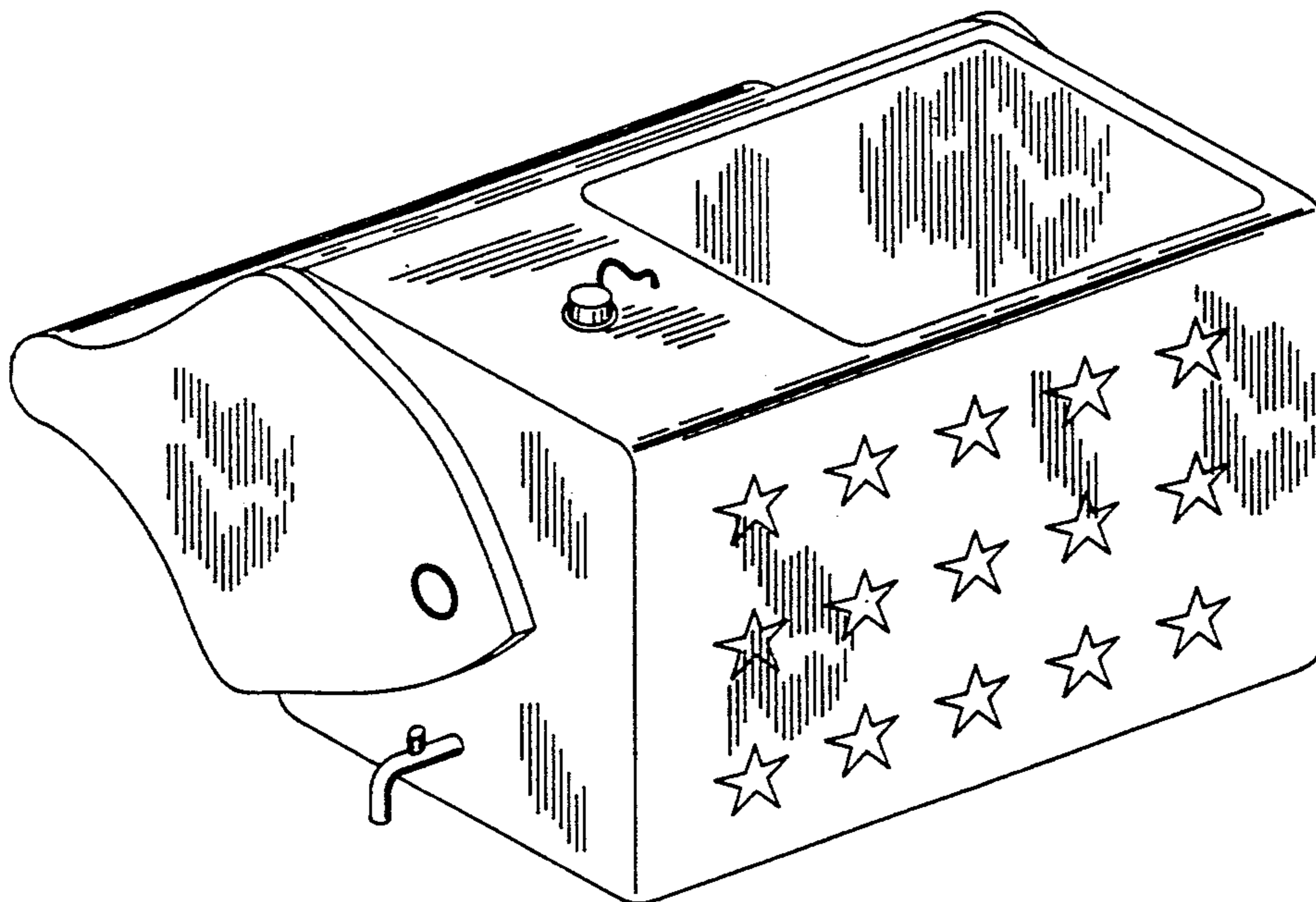
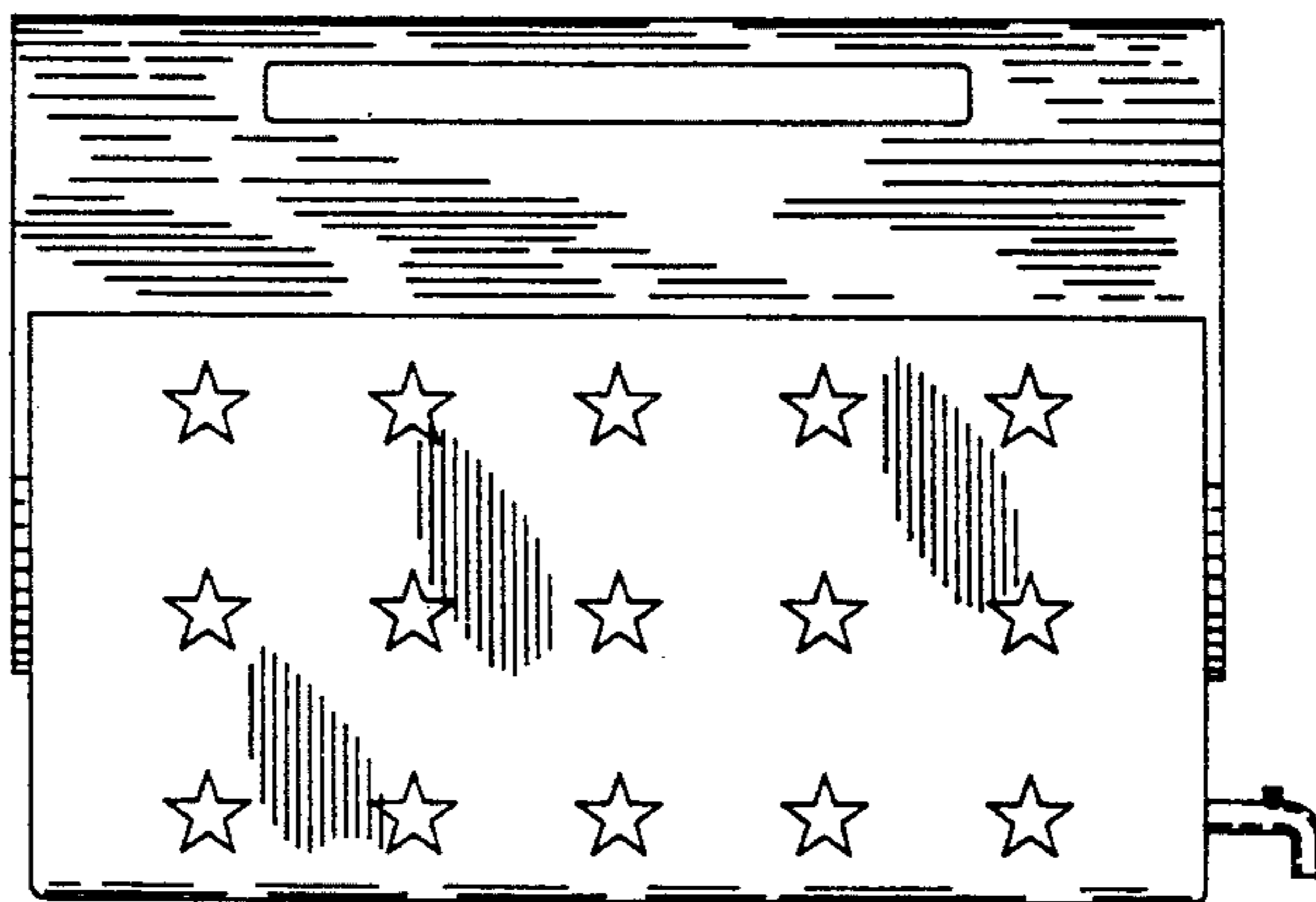

FIG. 1

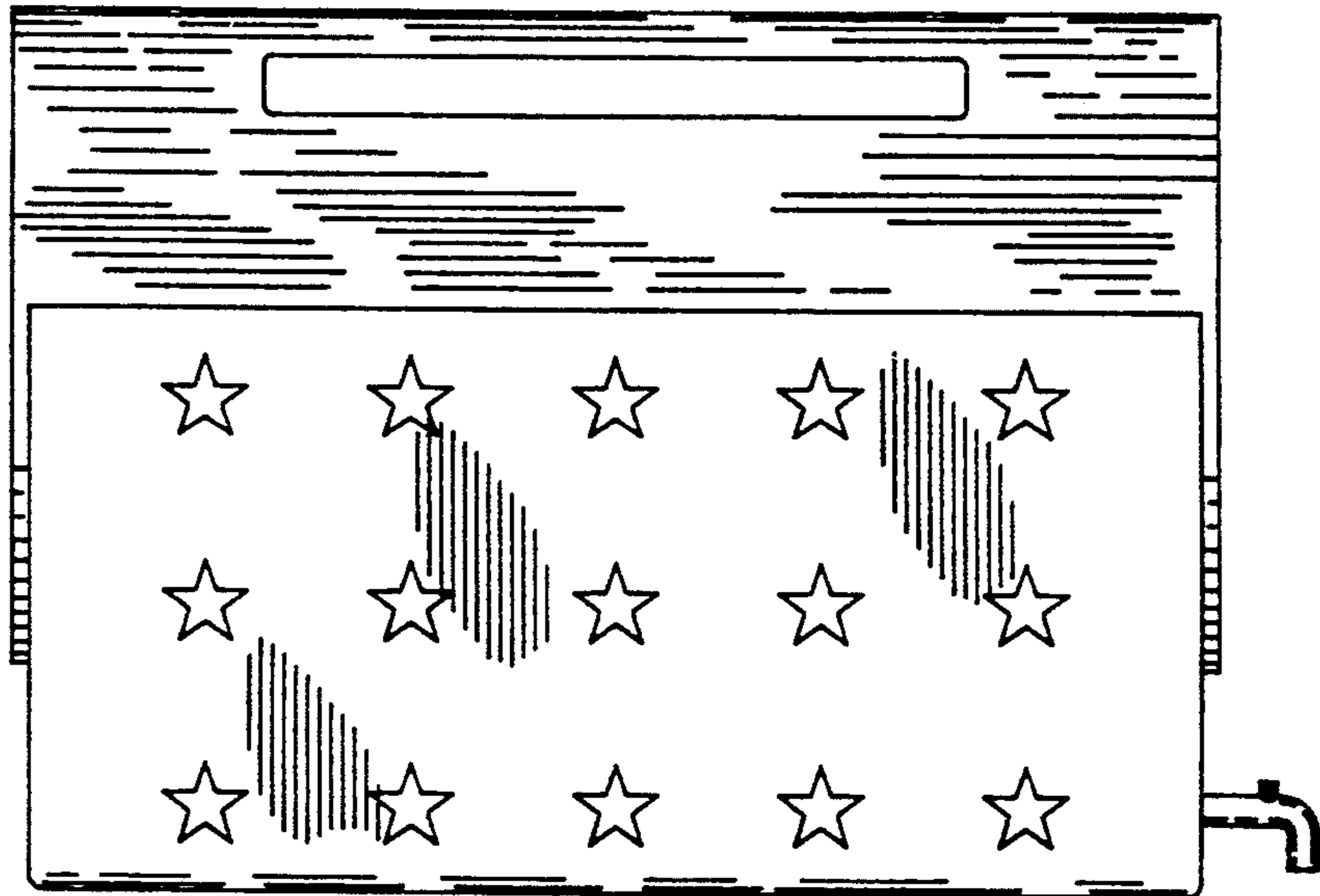

FIG. 2

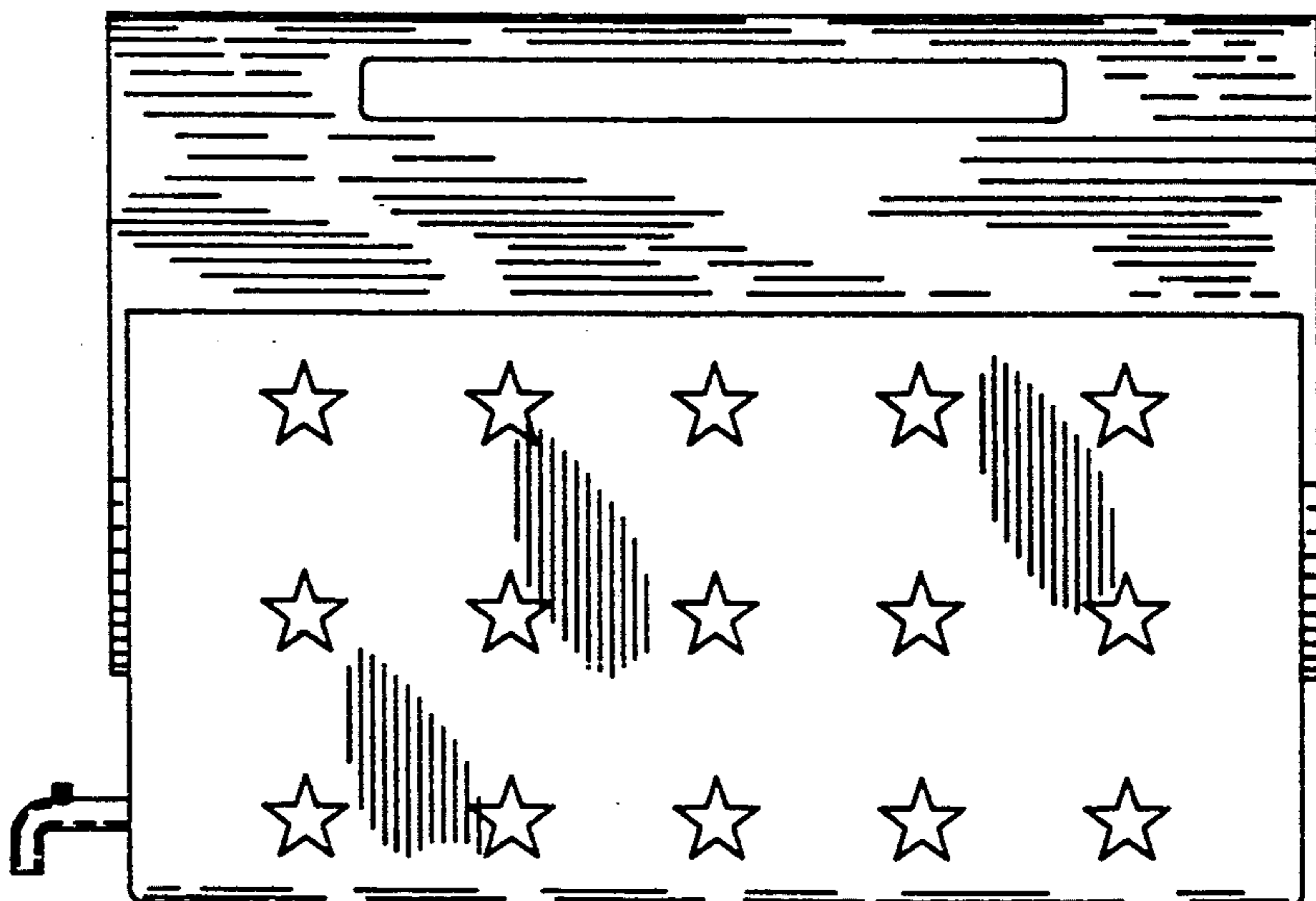

FIG. 3

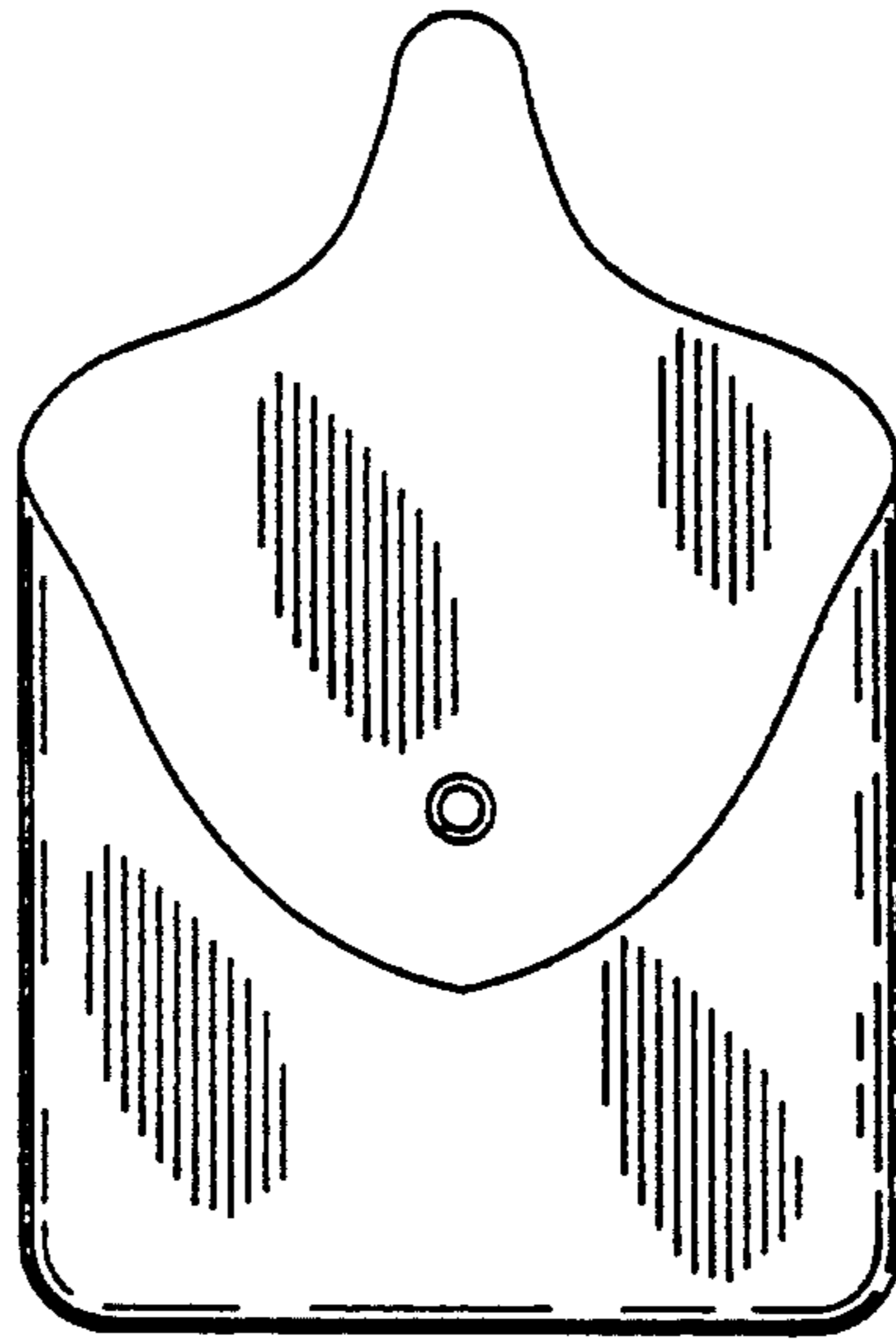

FIG. 4

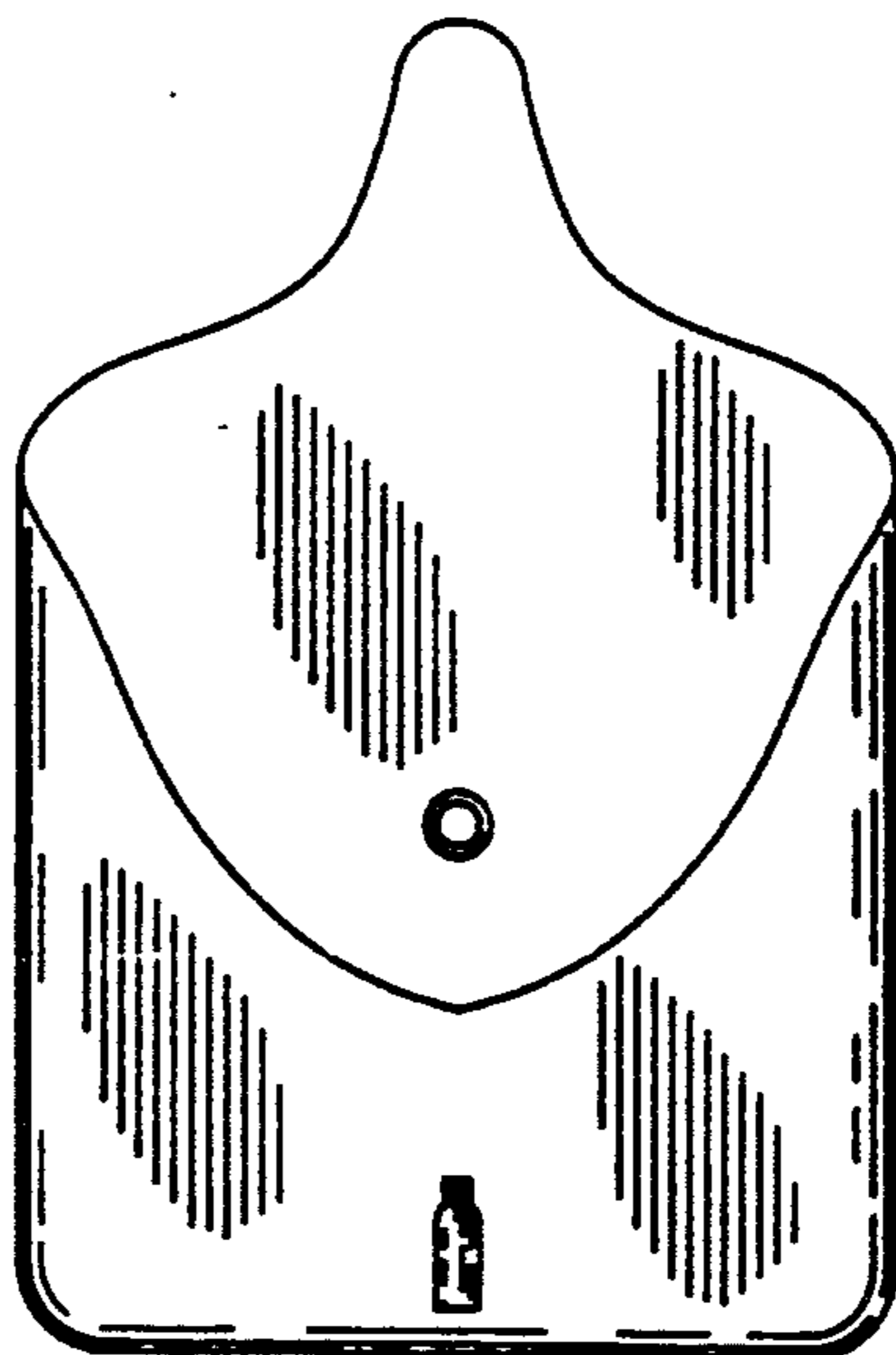

FIG. 5

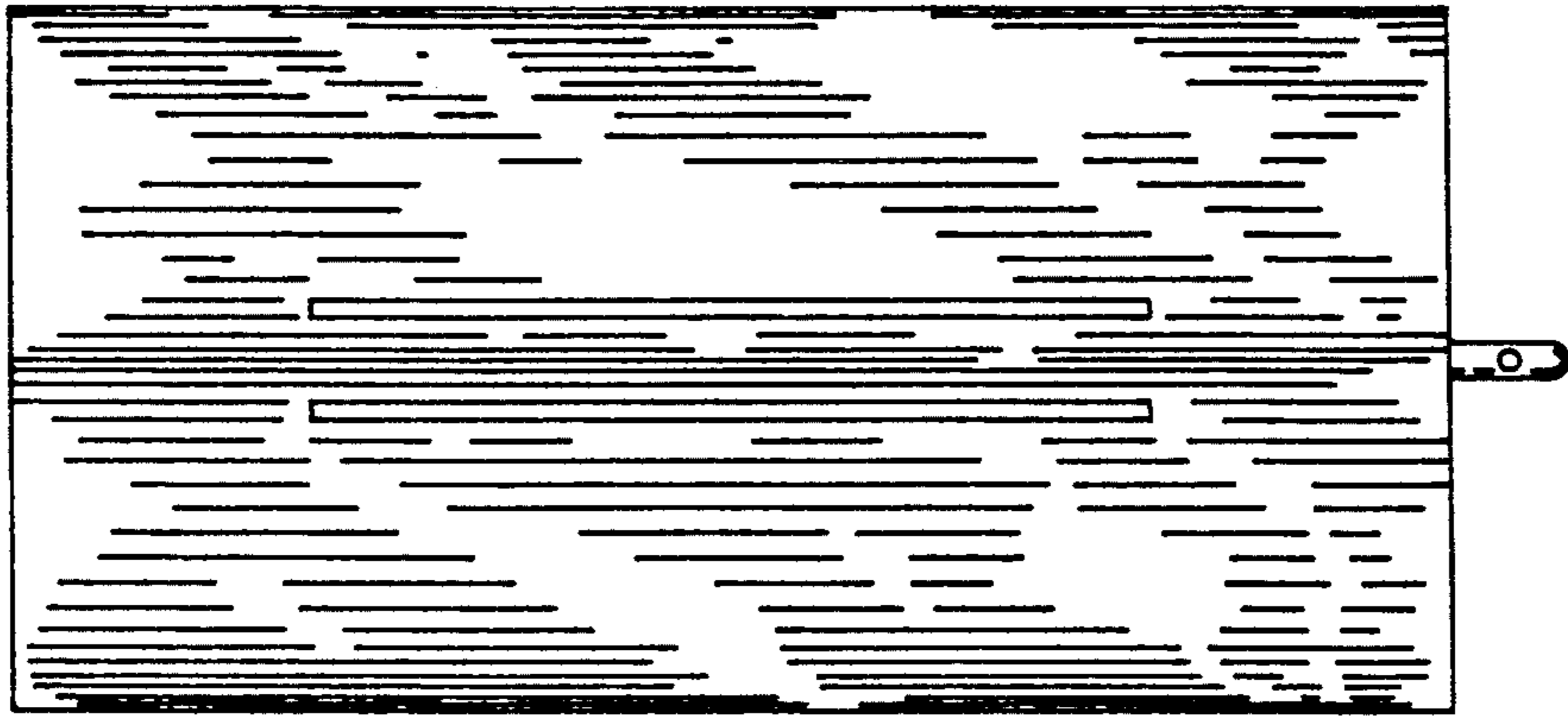

FIG. 6

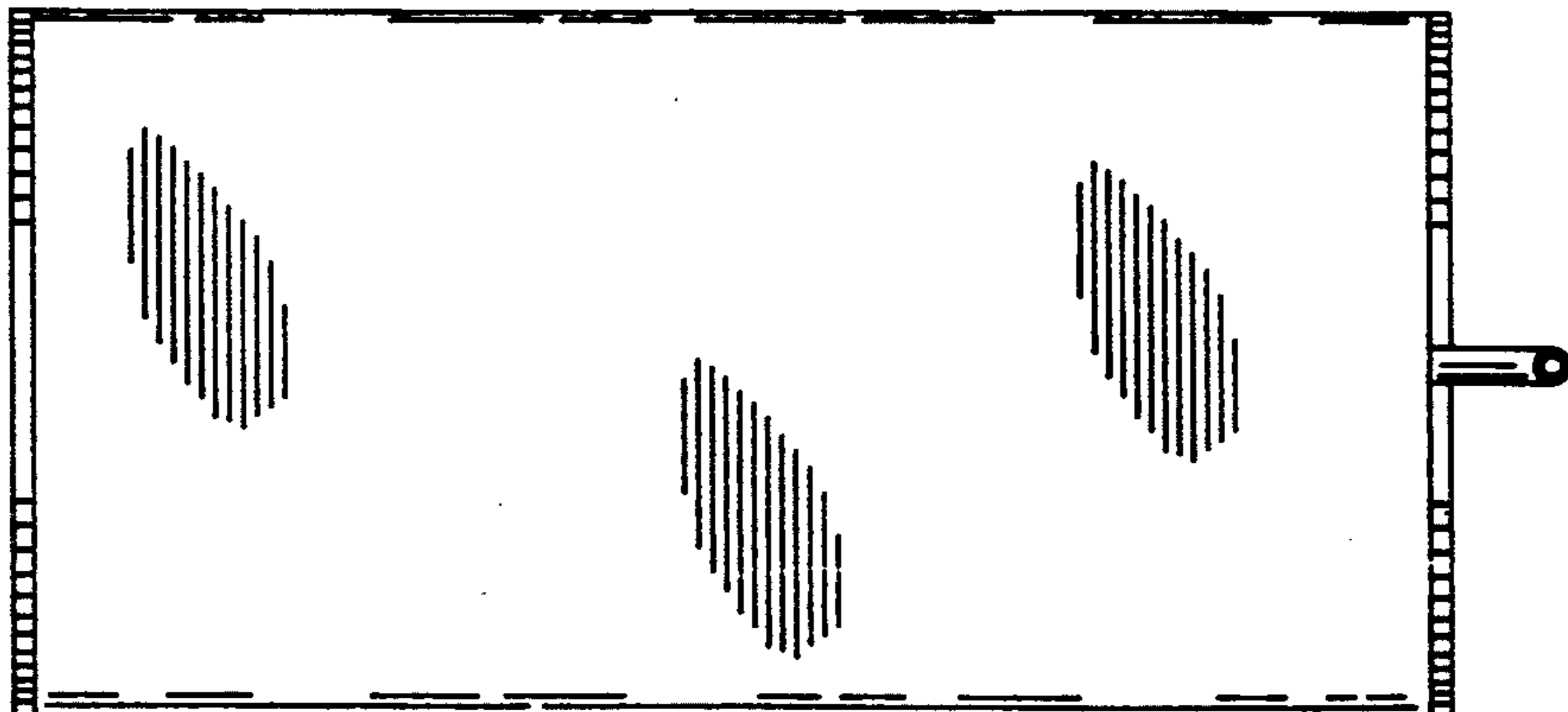

FIG. 7

