



US00D328995S

United States Patent [19]

Verheijen

[11] Patent Number: **Des. 328,995**

[45] Date of Patent: **** Sep. 1, 1992**

[54] COFFEE MAKER

[75] Inventor: **Jan J. Verheijen**, Heilo, Netherlands

[73] Assignee: **Verheijen B.V.**, Heerhugowaard, Netherlands

[**] Term: **14 Years**

[21] Appl. No.: **388,905**

[22] Filed: **Aug. 3, 1989**

[52] U.S. Cl. **D7/309; D7/307; D7/312**

[58] Field of Search **D7/300, 305, 308, 309, D7/312, 311, 307, 313**

[56] References Cited

U.S. PATENT DOCUMENTS

D. 250,536	12/1978	Bourke	D7/308
D. 274,029	5/1984	Daugherty	D7/309
D. 292,961	12/1987	Daugherty	D7/309
D. 309,843	8/1990	Reichmann	D7/311 X
4,478,139	10/1984	Zimmerman	D7/309 X

OTHER PUBLICATIONS

Jet Spray Cold Beverage Dispensers, brochure MJ241, Apr. 1, 1985, "Twin Jet", #TJ3 and Jet Bank JS7/Top Two Machines.

Vending Times, Aug. 1988, p. 18, Newco D-Series Dual Brewer-top center panel in adv.

Primary Examiner—Donald P. Walsh

Assistant Examiner—Caron D. Veynar

Attorney, Agent, or Firm—Foley & Lardner

[57] CLAIM

The ornamental design for a coffee maker, as shown and described.

DESCRIPTION

FIG. 1 is a front perspective view of a coffee maker showing my new design;

FIG. 2 is a right side elevational view thereof;

FIG. 3 is a rear elevational view thereof;

FIG. 4 is a front elevational view thereof;

FIG. 5 is a left side elevational view thereof;

FIG. 6 is a top plan view thereof; and,

FIG. 7 is a bottom plan view thereof.

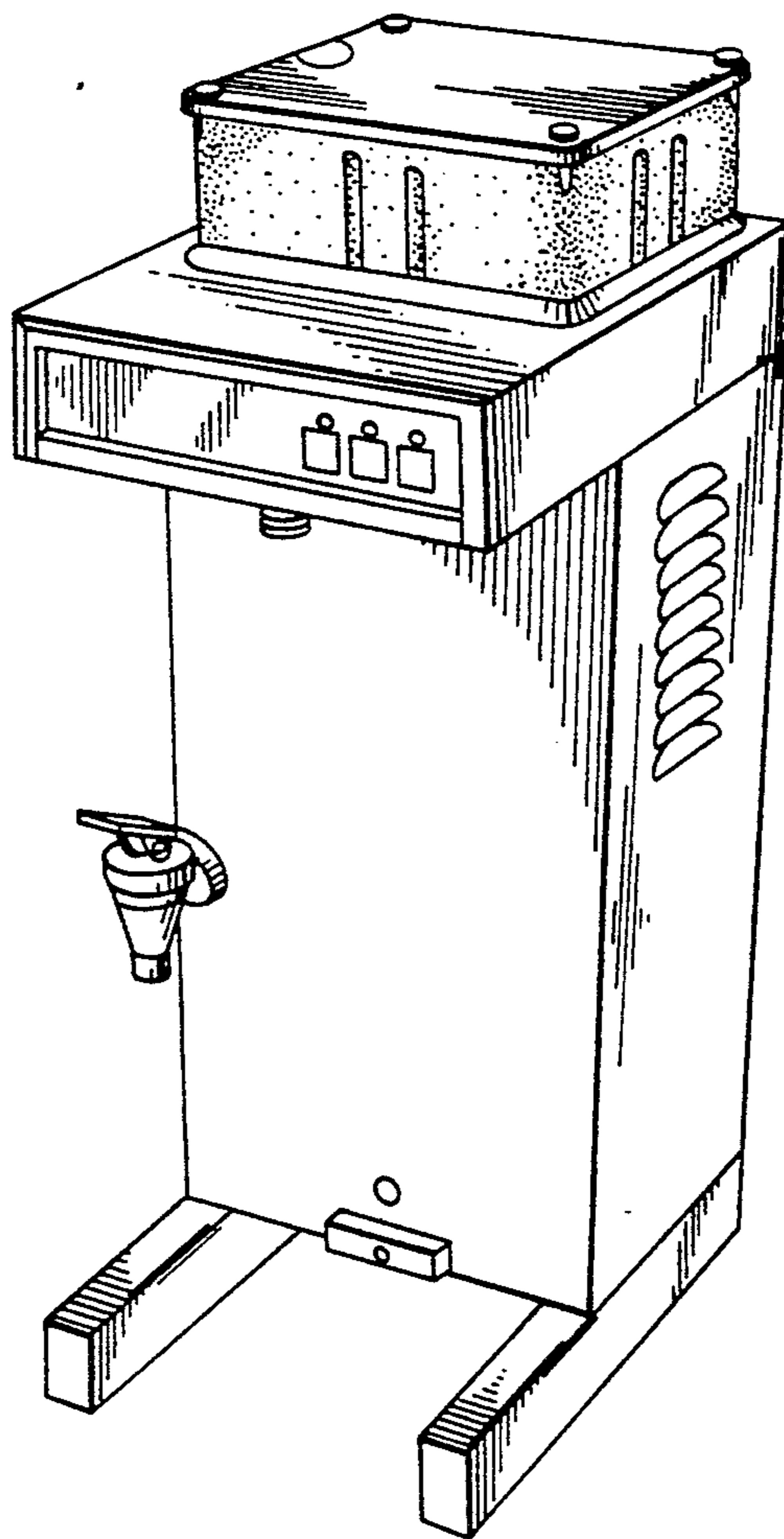

FIG. 3

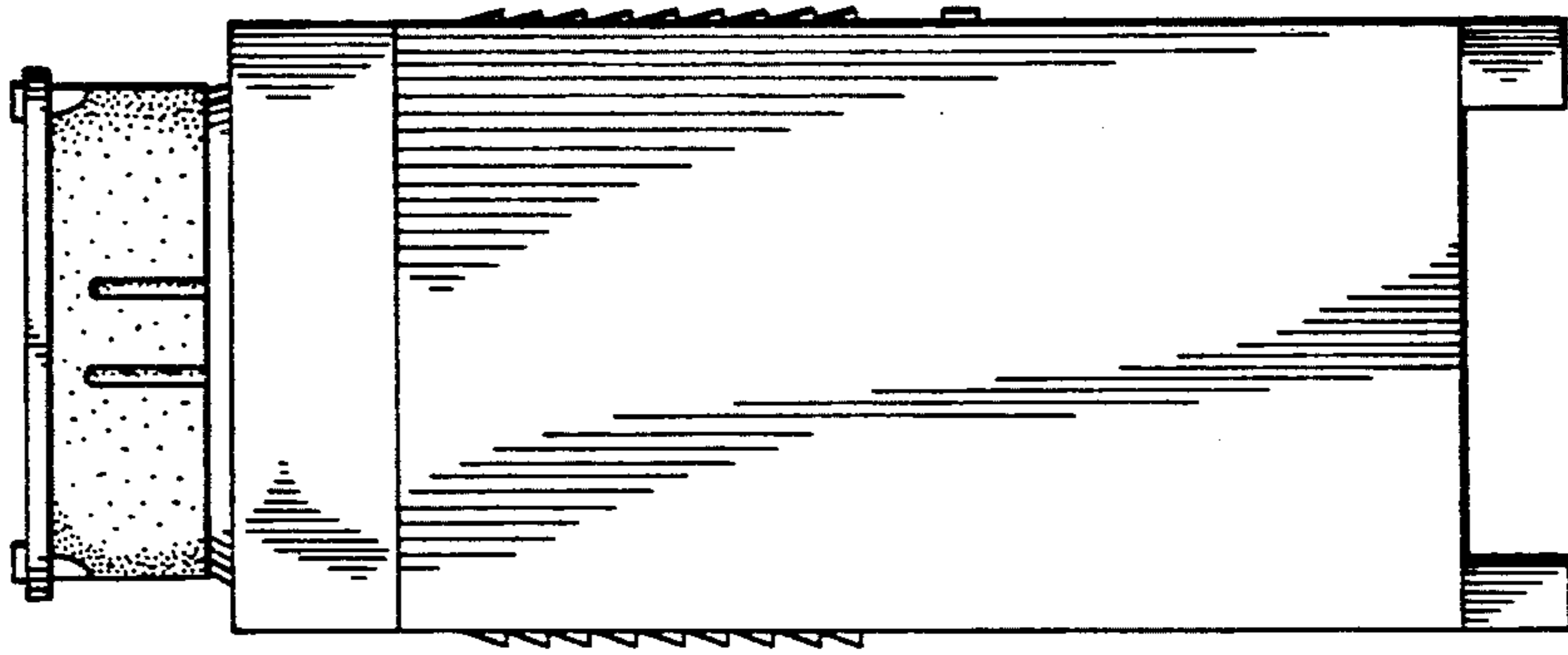

FIG. 2

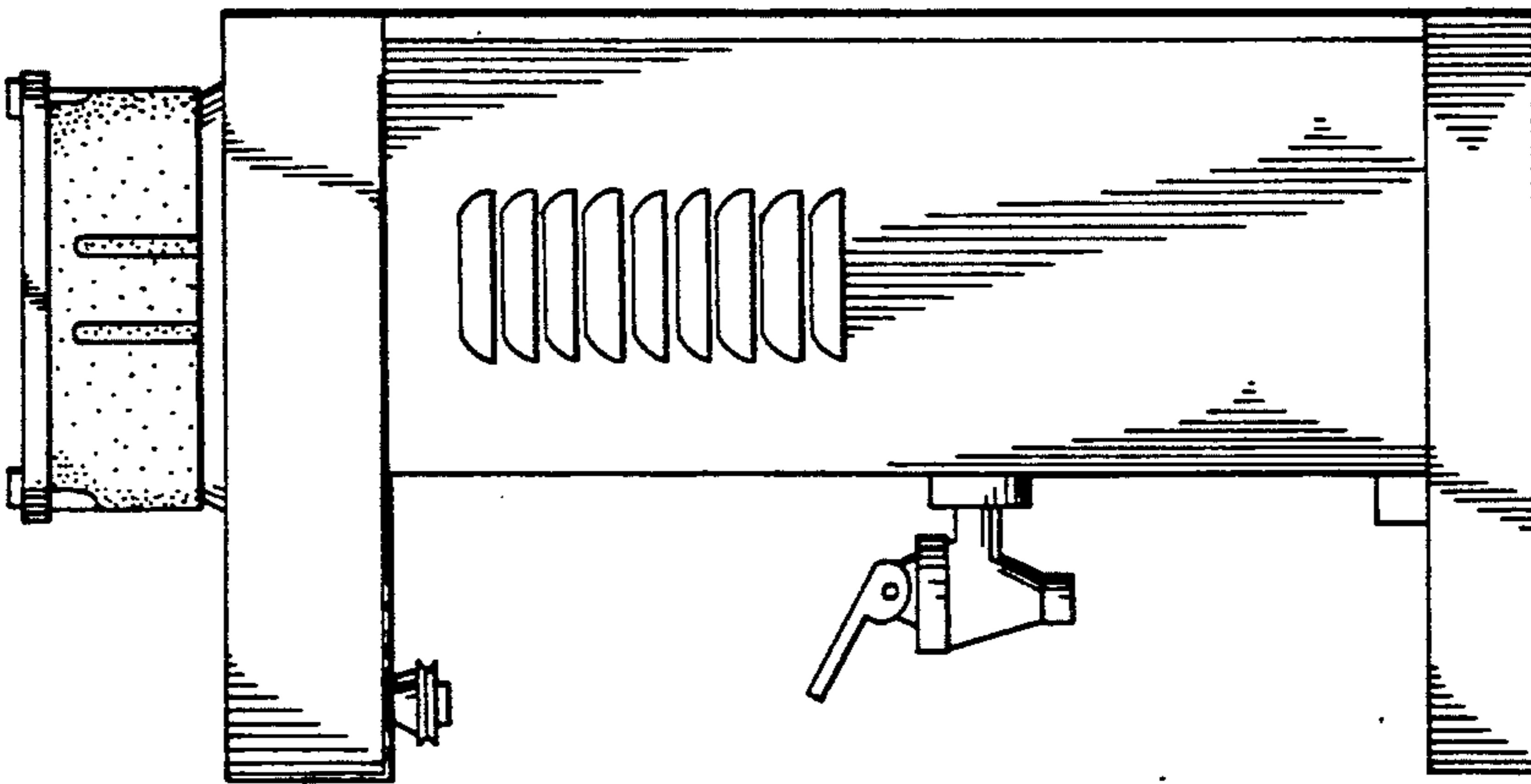

FIG. 1

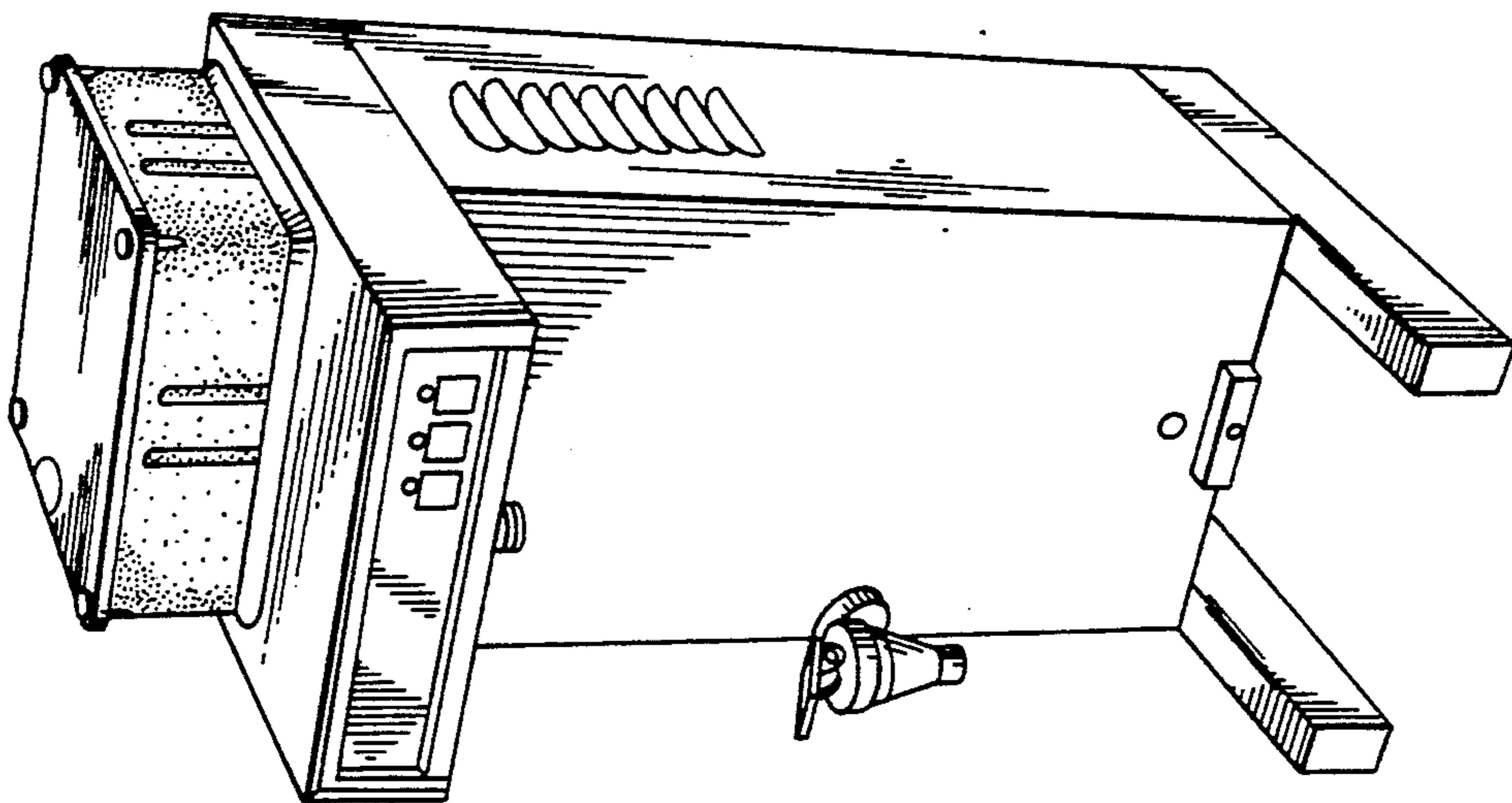

FIG. 4

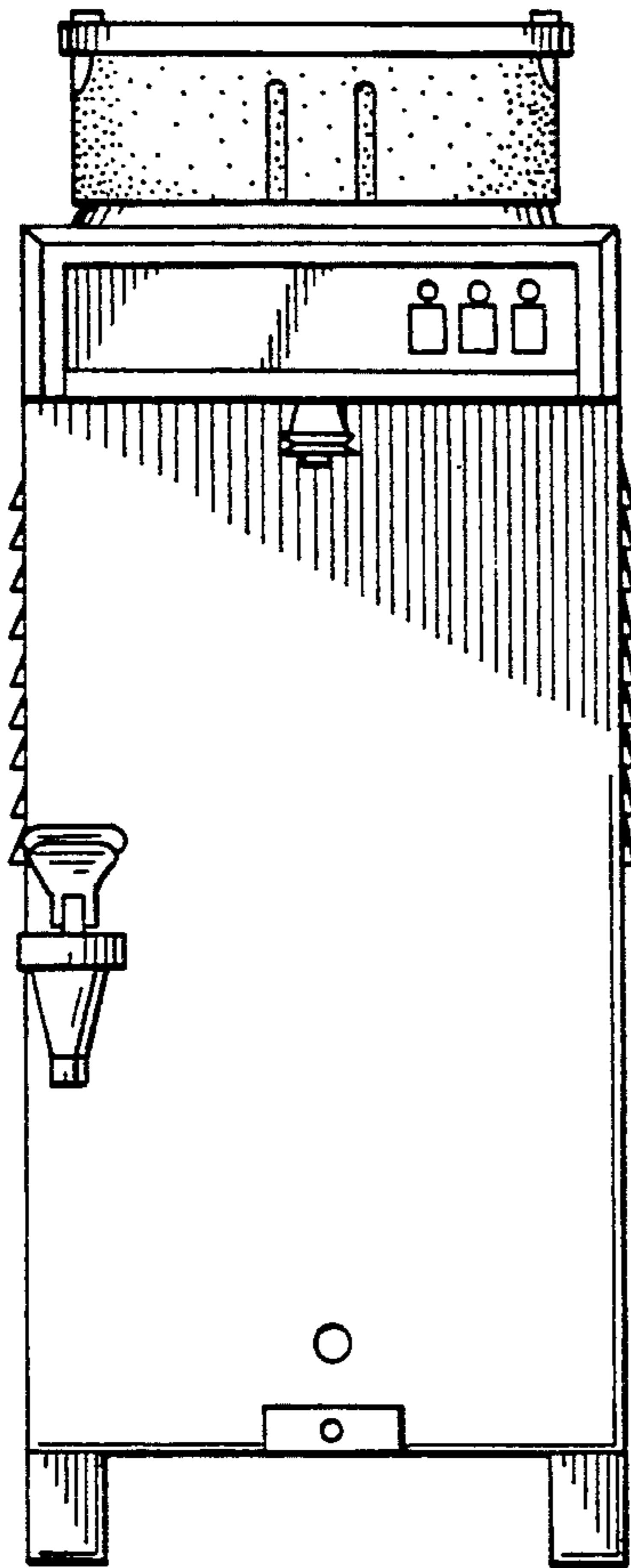

FIG. 5

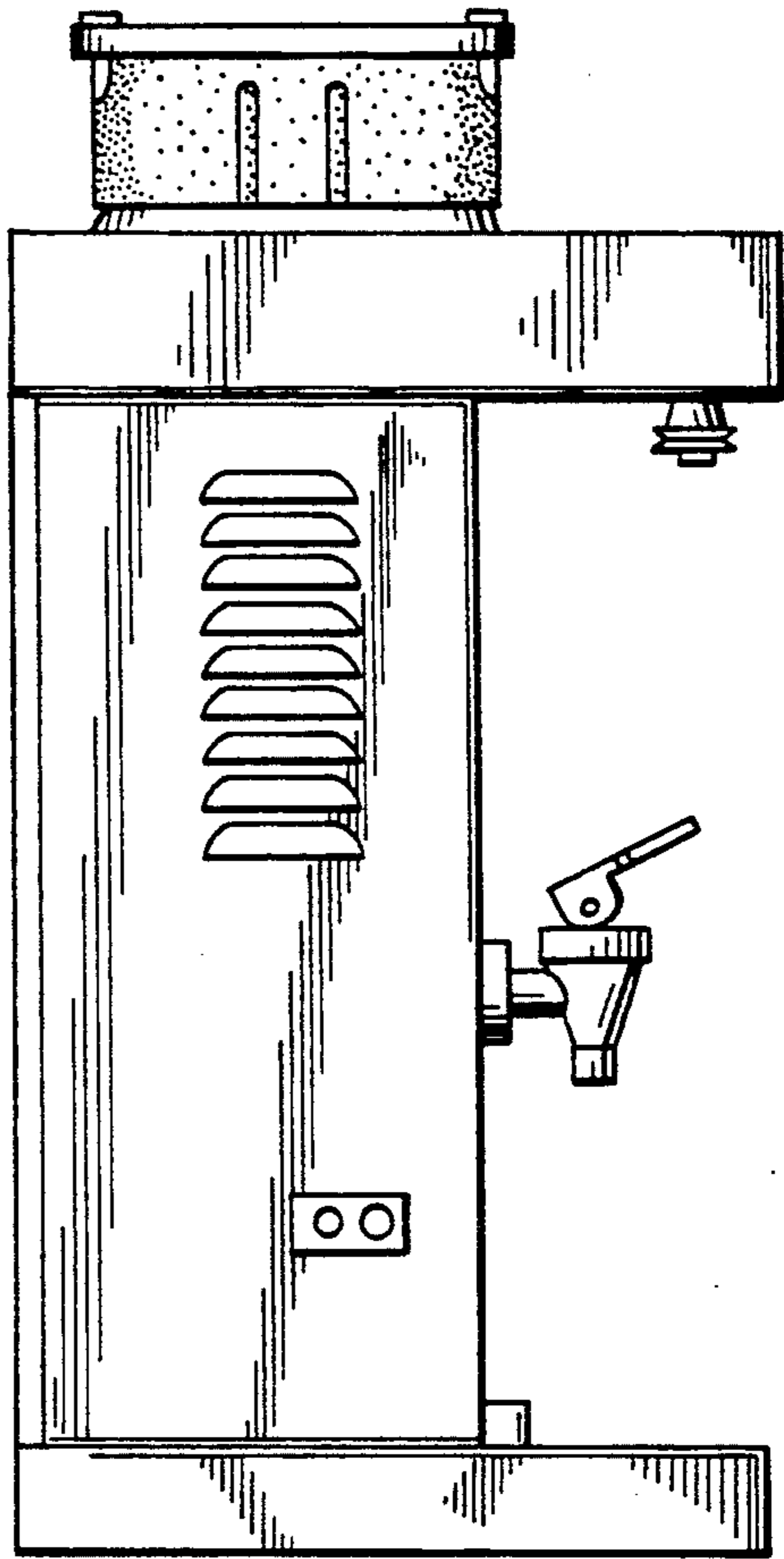

FIG. 6

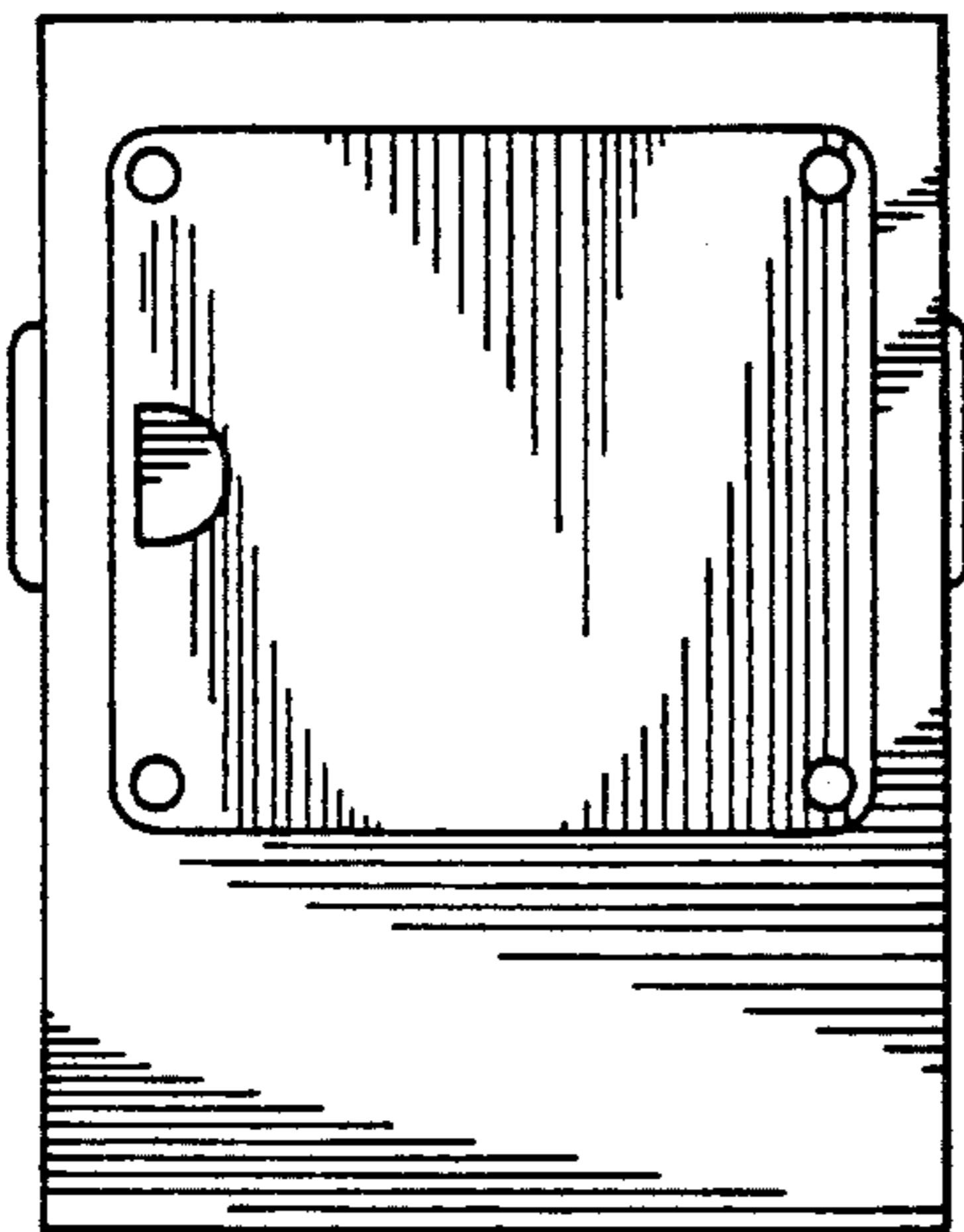

FIG. 7

