



US00D328928S

# United States Patent [19]

[11] Patent Number: **Des. 328,928**

**Järnros**

[45] Date of Patent: **\*\* Aug. 25, 1992**

[54] **TOY BUILDING ELEMENT**

3,034,254 5/1962 Christiansen ..... 446/128

[75] Inventor: **Claes-Runo Albert E. Järnros,**  
Billund, Denmark

*Primary Examiner*—Bernard Ansher  
*Assistant Examiner*—R. Barkai  
*Attorney, Agent, or Firm*—Kane, Dalsimer, Sullivan,  
Kurucz, Levy, Eisele and Richard

[73] Assignee: **Interlego A.G.,** Baar, Switzerland

[\*\*] Term: **14 Years**

[57] **CLAIM**

[21] Appl. No.: **621,946**

The ornamental design for a toy building element, as shown and described.

[22] Filed: **Dec. 4, 1990**

[52] U.S. Cl. .... **D21/108**

**DESCRIPTION**

[58] Field of Search ..... D21/108, 141; D25/115,  
D25/118; 446/93, 94, 95, 113, 118, 128, 121

FIG. 1 is a top perspective view of a toy building element showing my new design;  
FIG. 2 is a front elevational view thereof;  
FIG. 3 is a side elevational view thereof, the side opposite being a mirror image;  
FIG. 4 is a rear elevational view thereof;  
FIG. 5 is a top plan view thereof; and,  
FIG. 6 is a bottom plan view thereof.

[56] **References Cited**

**U.S. PATENT DOCUMENTS**

- D. 285,101 8/1986 Hakata ..... D21/108
- D. 285,705 9/1986 Dideriksen ..... D21/108
- D. 304,046 10/1989 Knudsen ..... D21/108

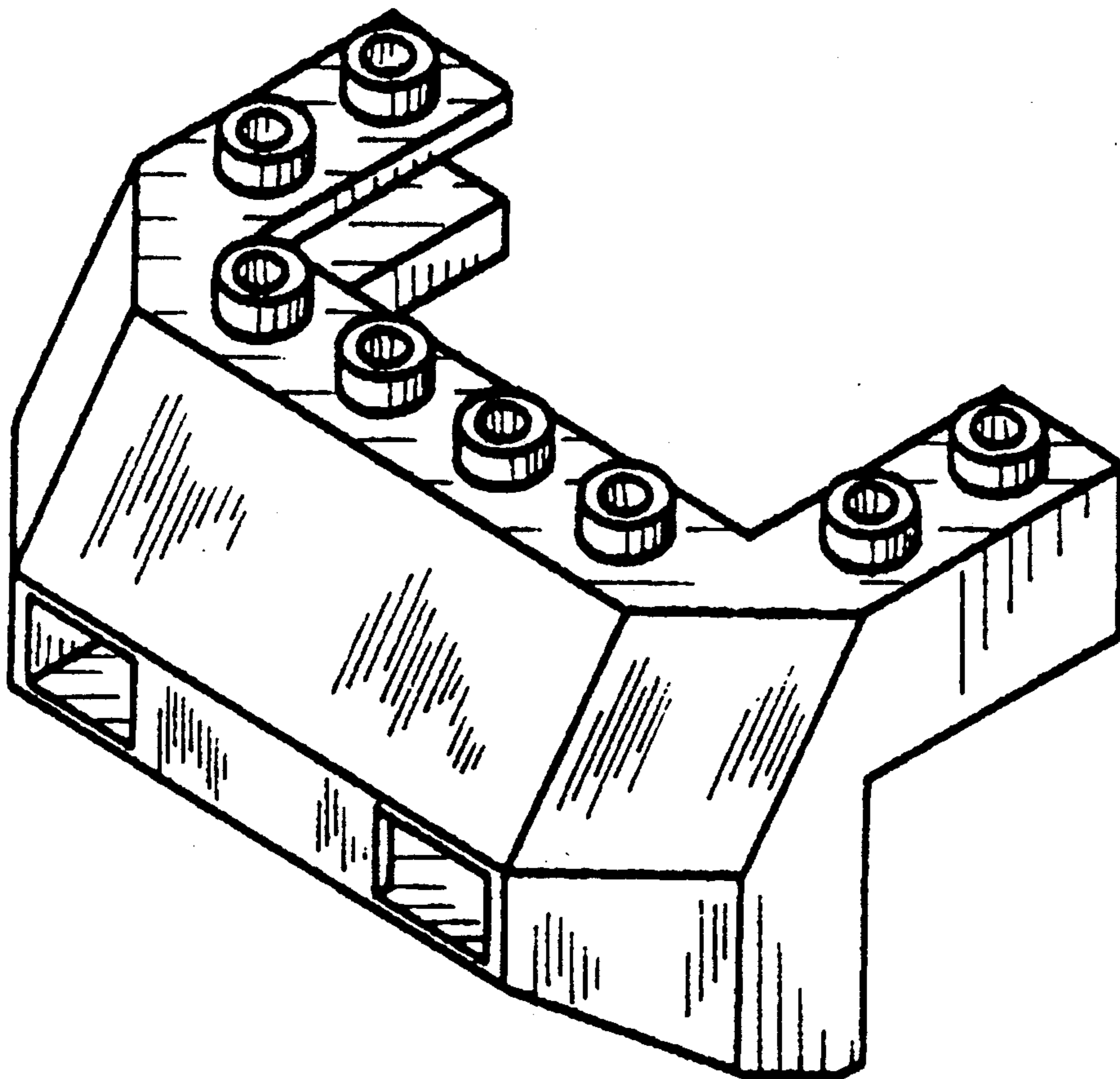

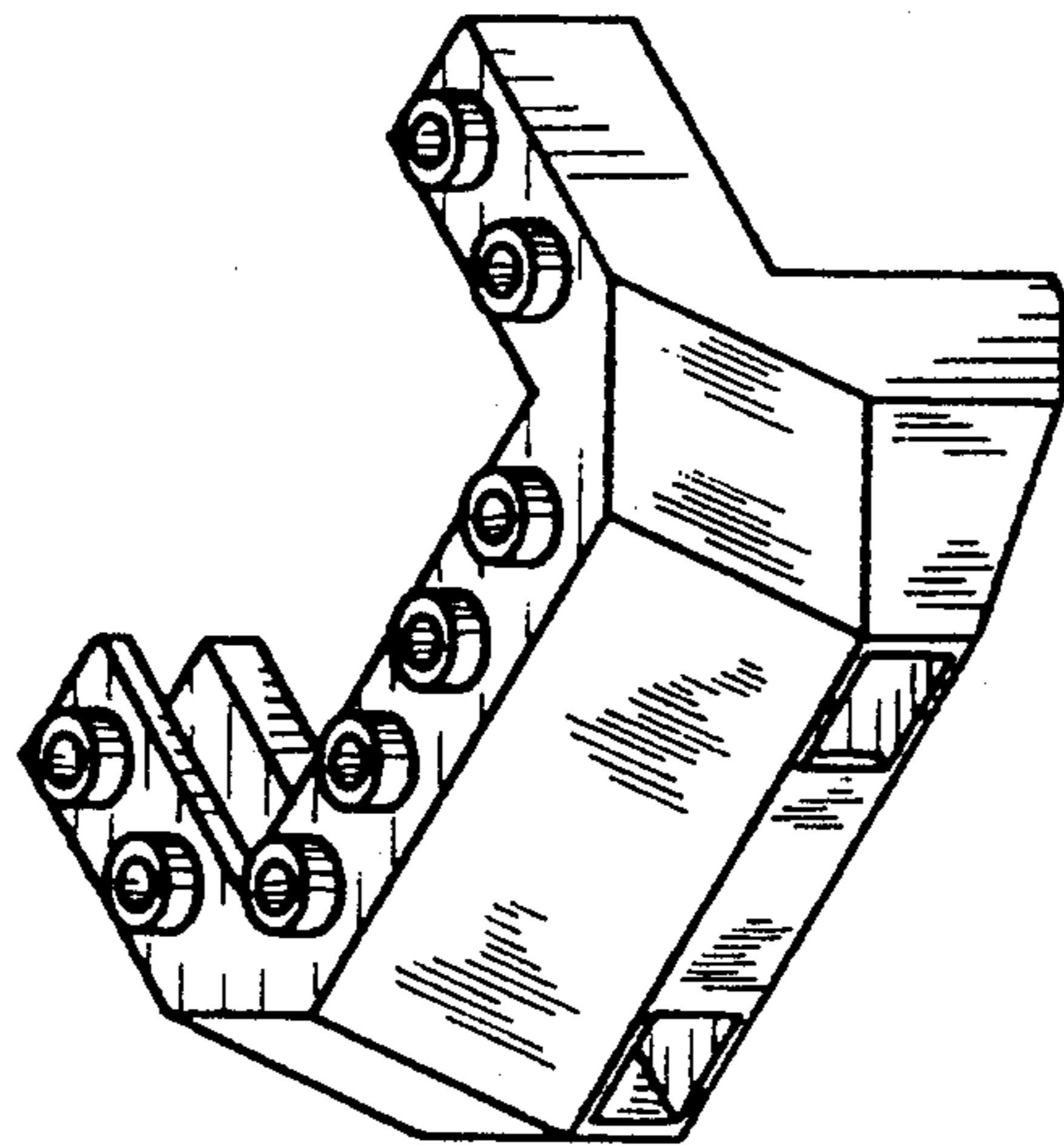

FIG. 1

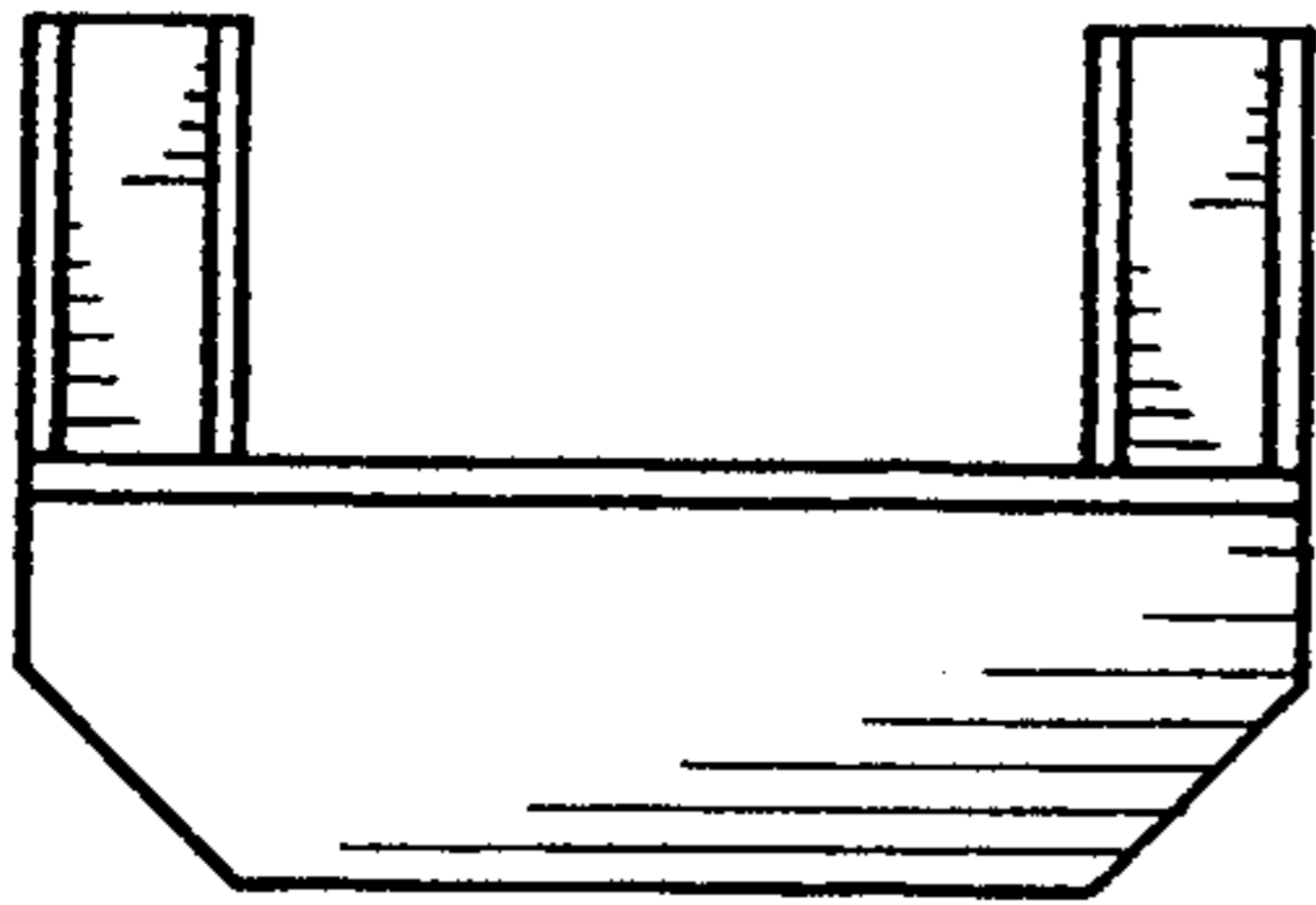

FIG. 6

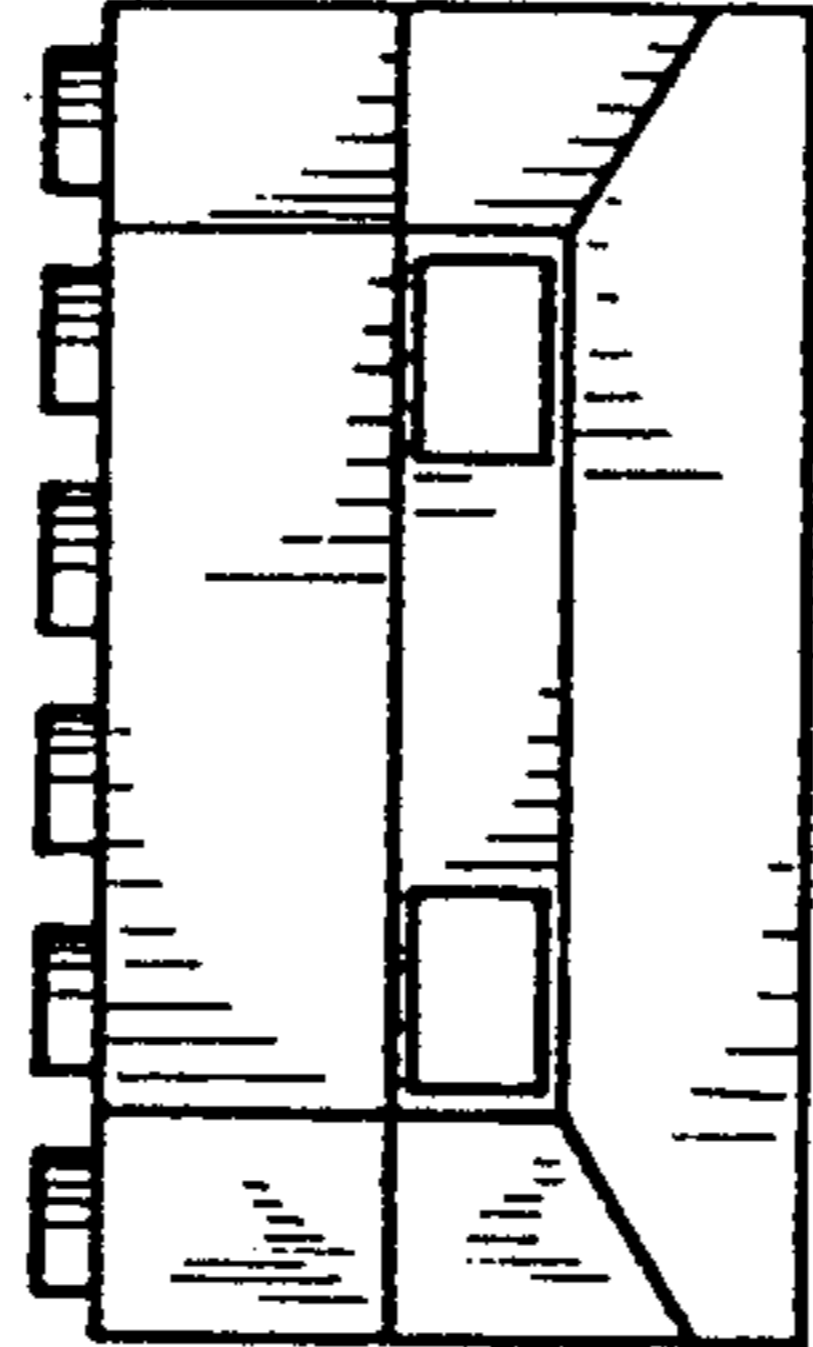

FIG. 2

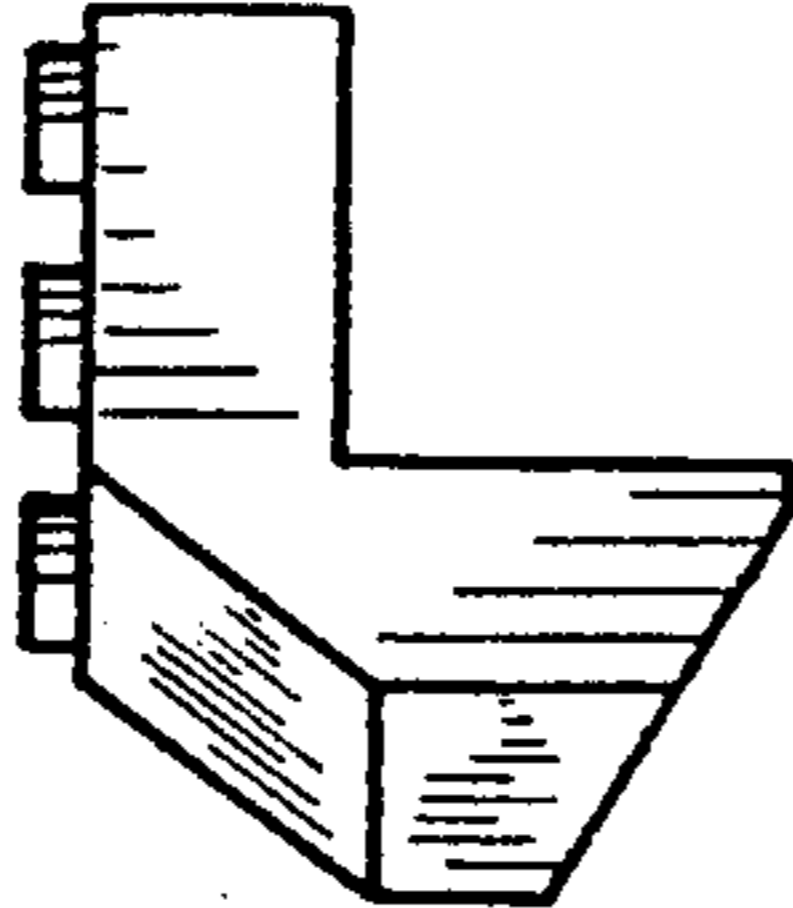

FIG. 3

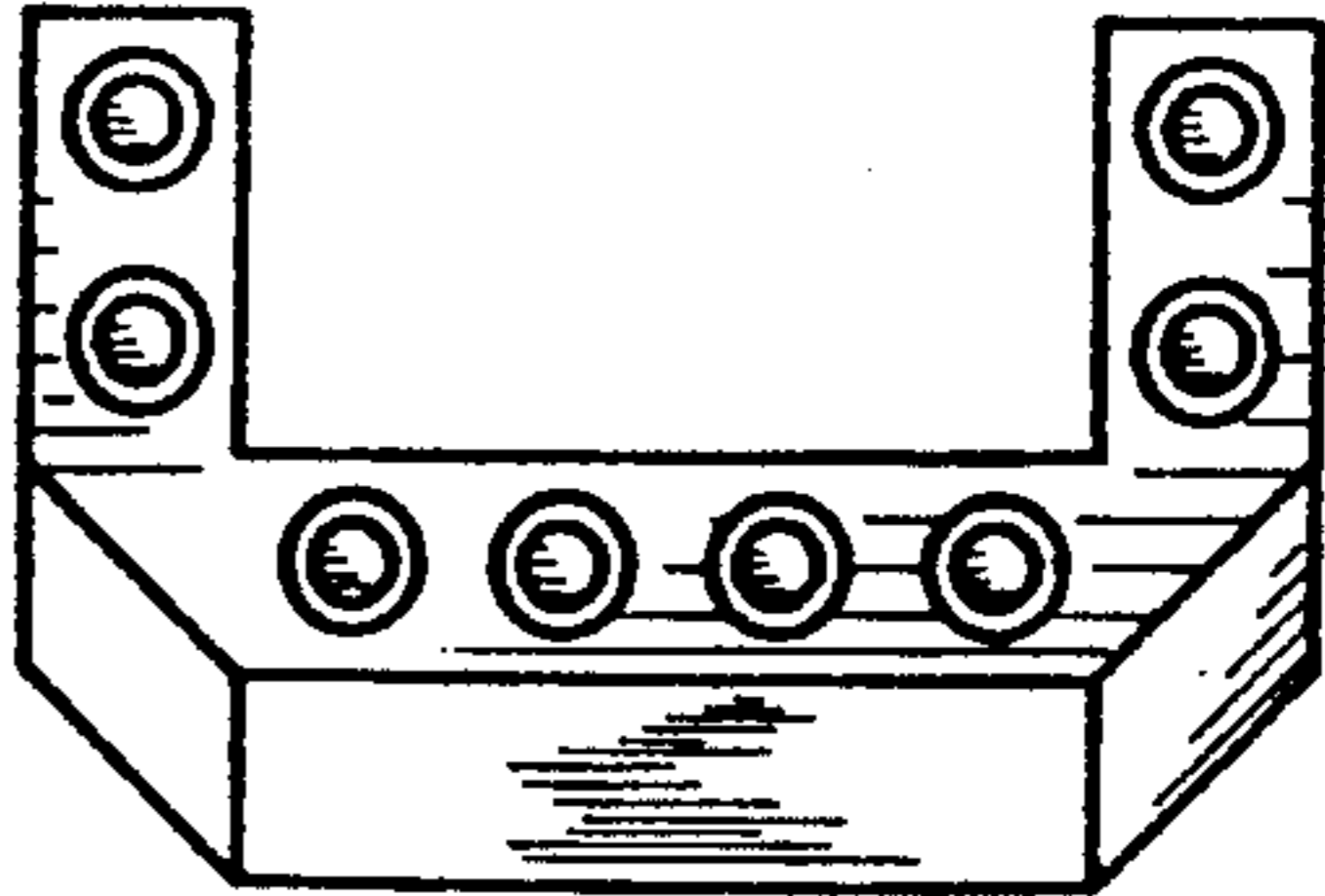

FIG. 5

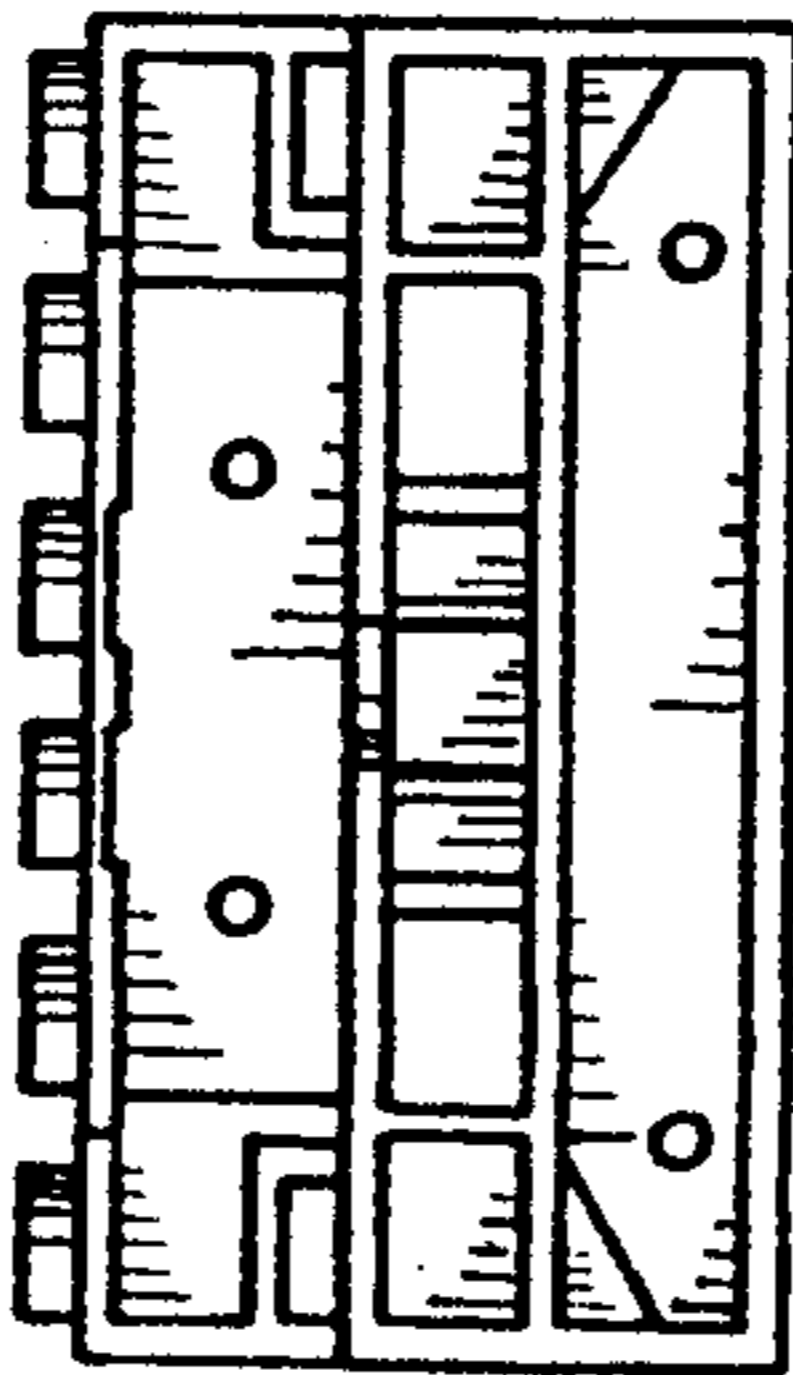

FIG. 4