



US00D328920S

United States Patent [19]

[11] Patent Number: Des. 328,920

Kimball

[45] Date of Patent: ** Aug. 25, 1992

[54] FINGER-MOUNTABLE HOLDER FOR A WRITING INSTRUMENT

4,846,710 7/1989 Campbell 434/166

[76] Inventor: Richard Kimball, 12708 263rd Ave. SE., Monroe, Wash. 98272

FOREIGN PATENT DOCUMENTS

331903 10/1903 France 401/8

[**] Term: 14 Years

Primary Examiner—Nelson C. Holtje
Assistant Examiner—Martha Thompson
Attorney, Agent, or Firm—Christensen, O'Connor, Johnson & Kindness

[21] Appl. No.: 620,586

[22] Filed: Nov. 27, 1990

[52] U.S. Cl. D19/55; D19/54; D19/81; D19/83; 401/8

[57] CLAIM

[58] Field of Search D19/35, 36, 54, 55, D19/81, 83, 84, 99, 100; 401/6, 7, 8, 88; 434/166, 162, 233, 112

The ornamental design for a finger-mountable holder for a writing instrument, as shown and described.

DESCRIPTION

[56] References Cited

U.S. PATENT DOCUMENTS

D. 238,357	1/1976	DiCarlo	D19/36
D. 298,439	11/1988	Rusk	D19/55
503,011	8/1893	Stathem	401/8
967,410	8/1910	Montgomery	401/8
1,125,405	1/1915	Seabaugh	.	
1,206,976	12/1916	Barth	401/8
1,667,067	4/1928	Chesley	401/8
1,861,241	5/1932	Putnam	.	
1,879,456	9/1932	Parsons	.	
1,879,489	9/1932	Ray	401/8
2,292,324	8/1942	Lawrence	401/8
3,596,964	8/1971	Zazzara	401/8 X
3,947,977	4/1976	Bishop	35/36

FIG. 1 is a top, right front perspective view of a finger-mountable holder for a writing instrument showing my new design;

FIG. 2 is a top plan view thereof;

FIG. 3 is a front elevational view thereof;

FIG. 4 is a right side elevational view, the left side being a mirror image thereof;

FIG. 5 is a rear elevational view thereof;

FIG. 6 is a bottom plan view thereof;

FIG. 7 is a cross-sectional view taken in the direction of arrows 7—7 in FIG. 5; and,

FIG. 8 is a rear perspective view thereof, the finger fragment and writing instrument fragment being depicted by means of broken lines for illustrative purposes only and forming no part of the claimed design.

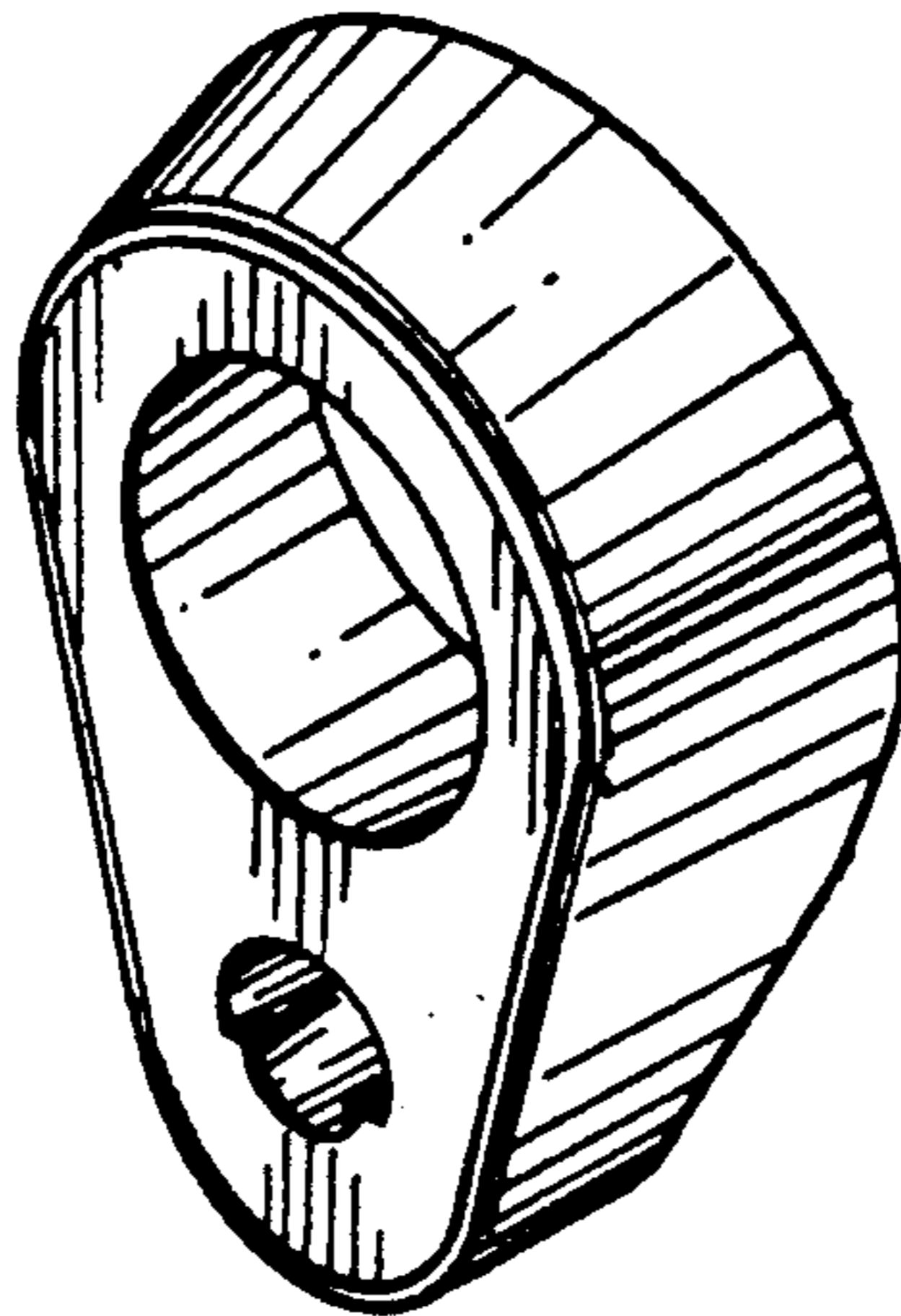

Fig. 1.

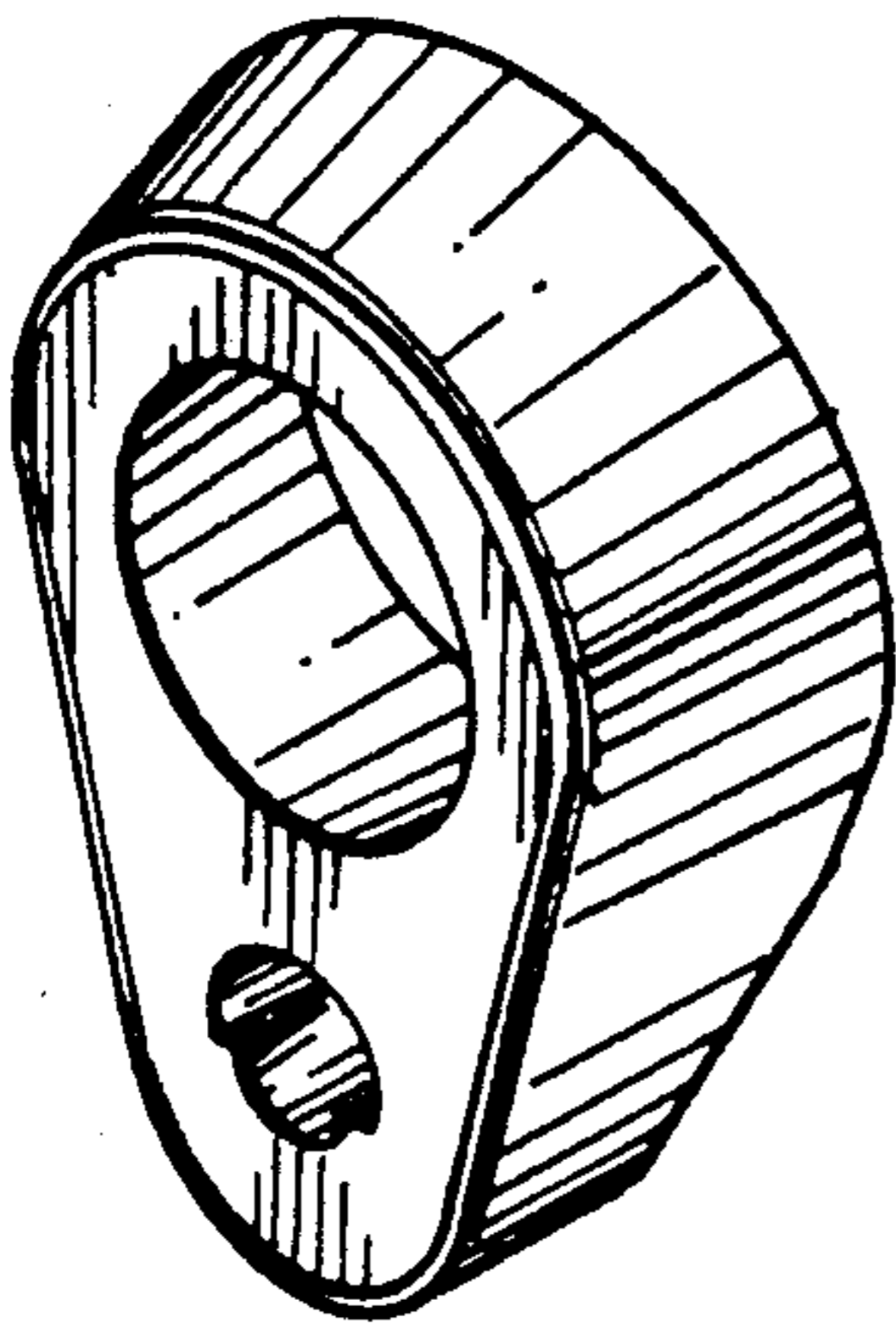

Fig. 2.

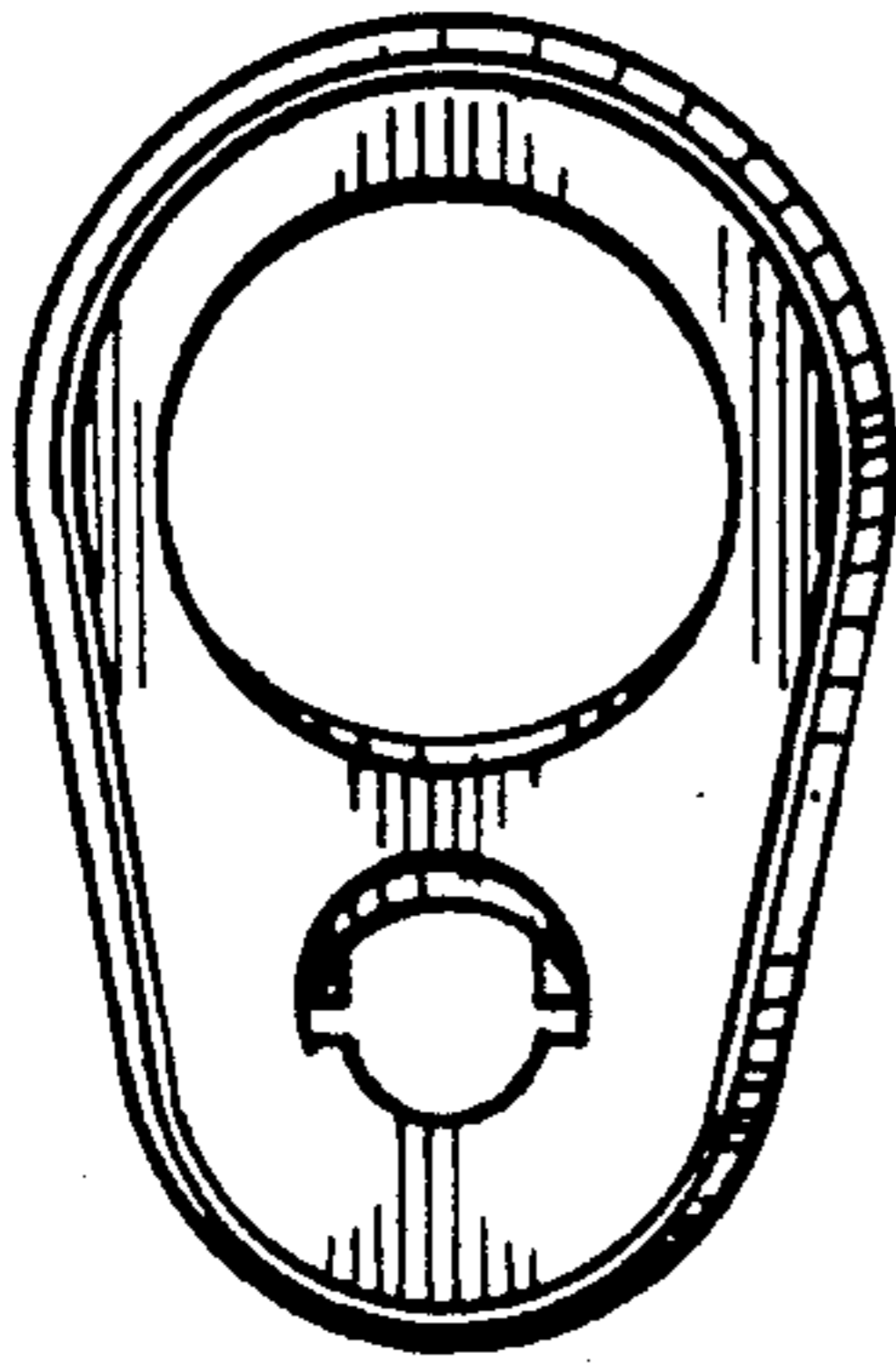
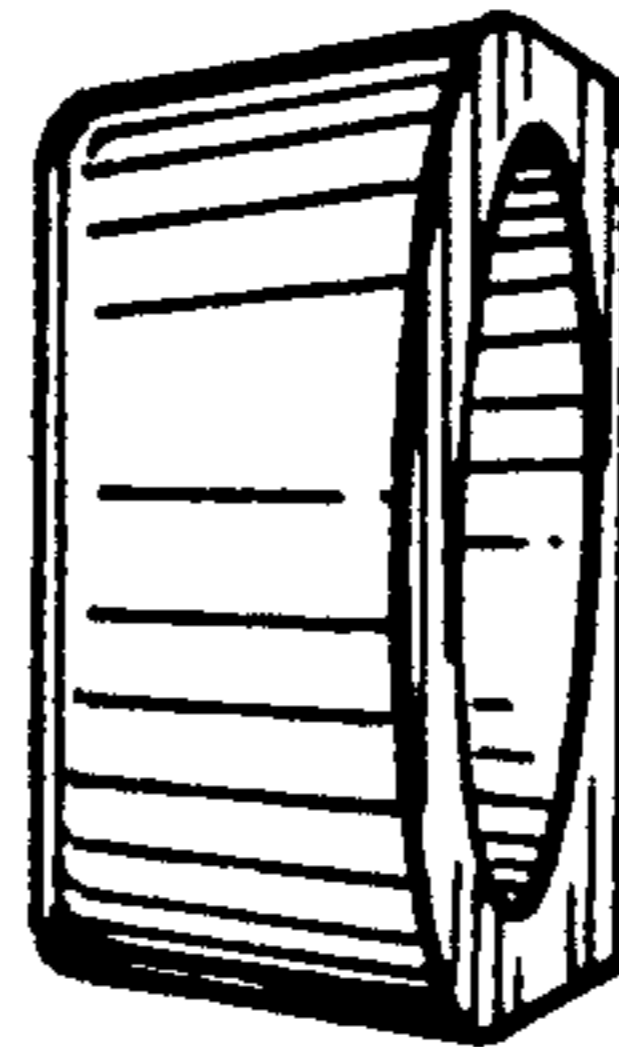

Fig. 3.

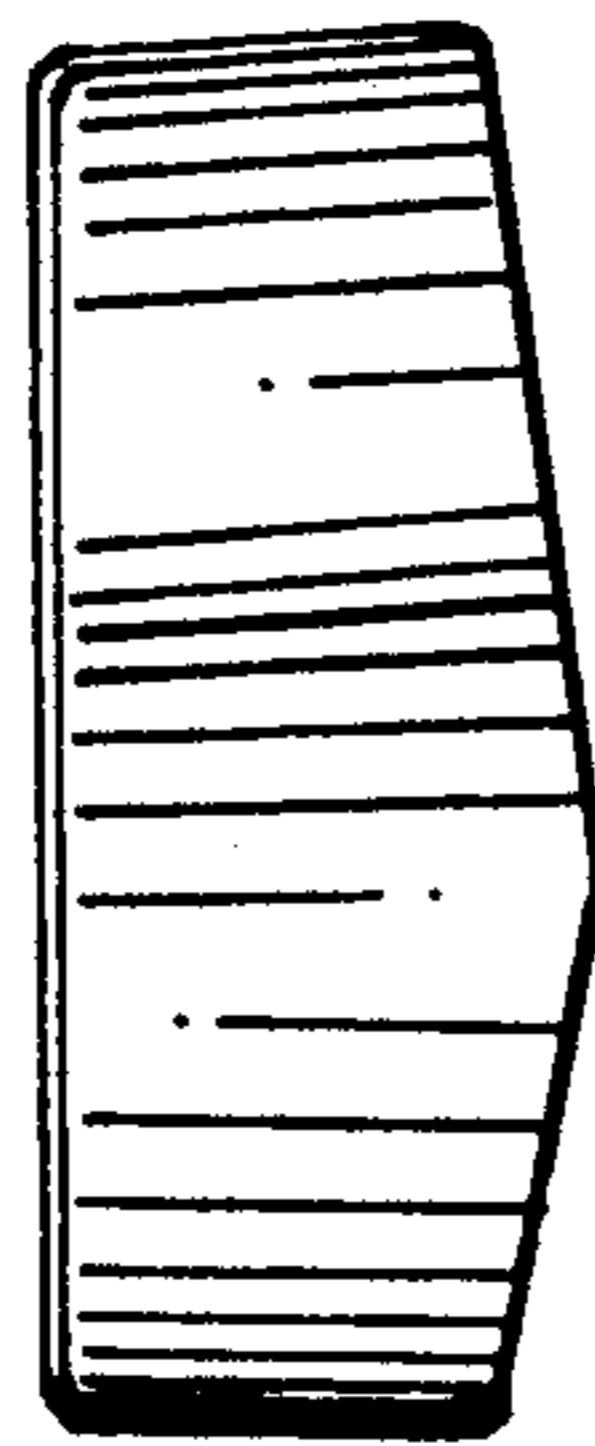

Fig. 4.

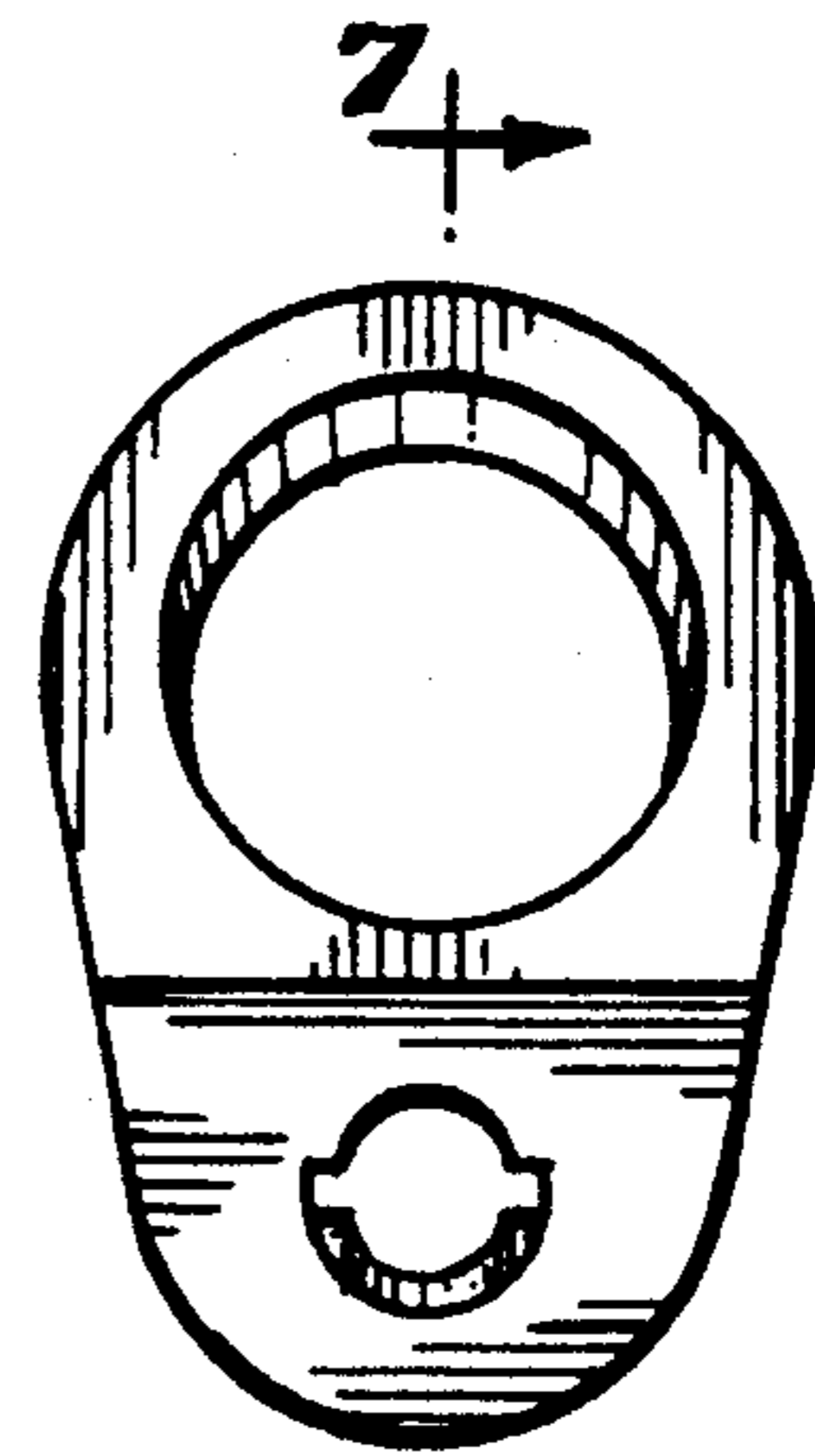

Fig. 5.

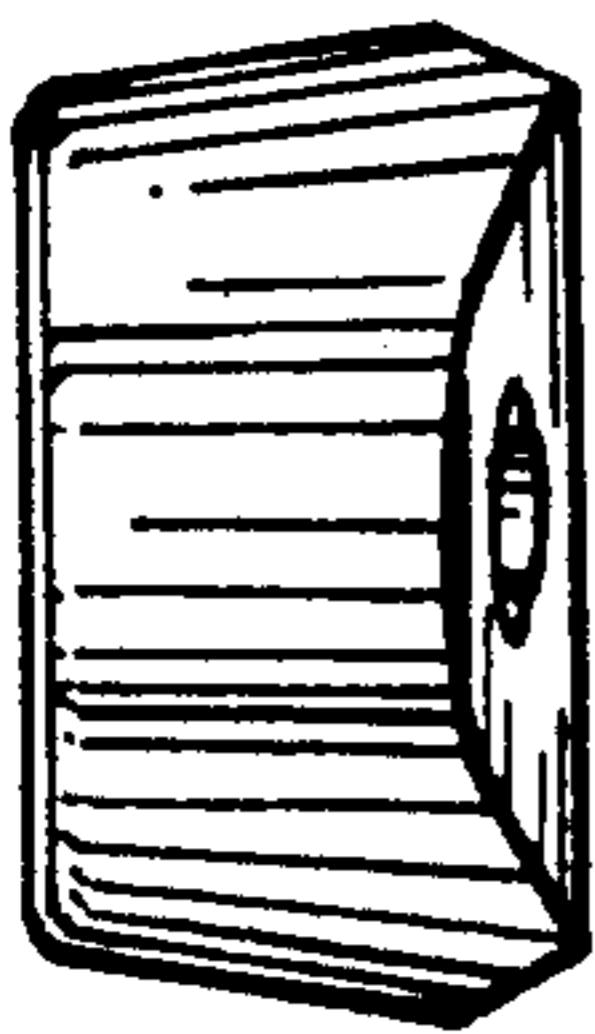

Fig. 6.

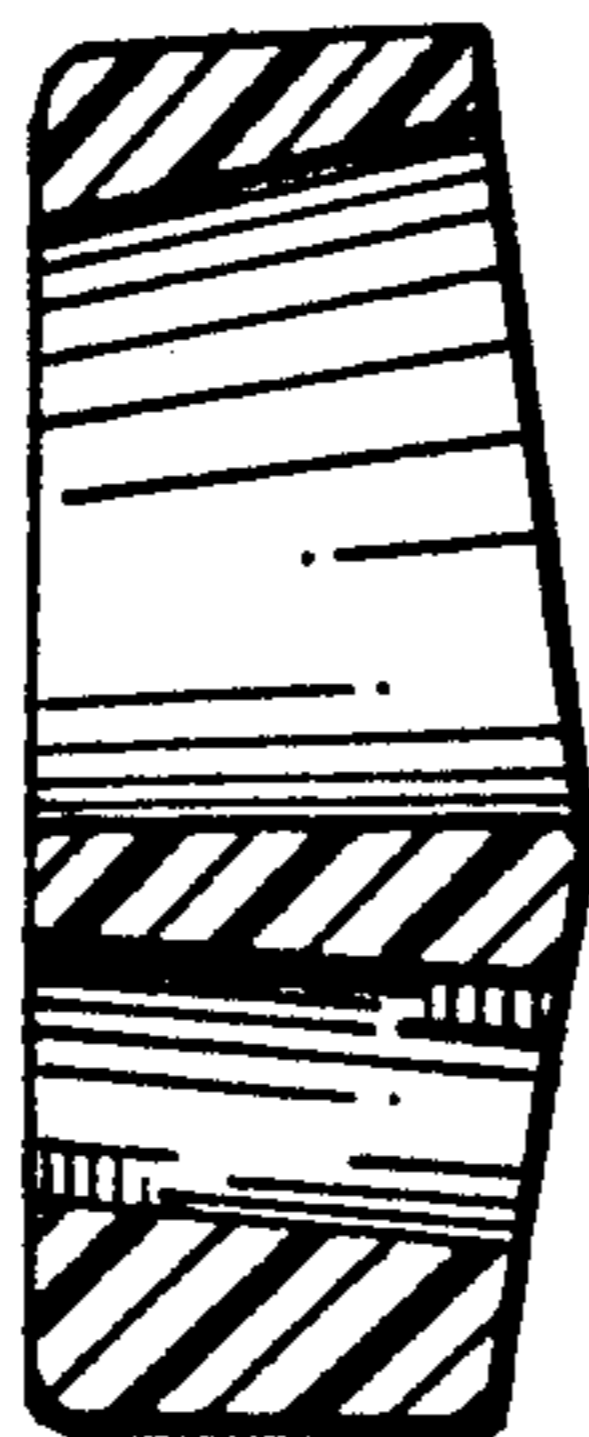

Fig. 7.

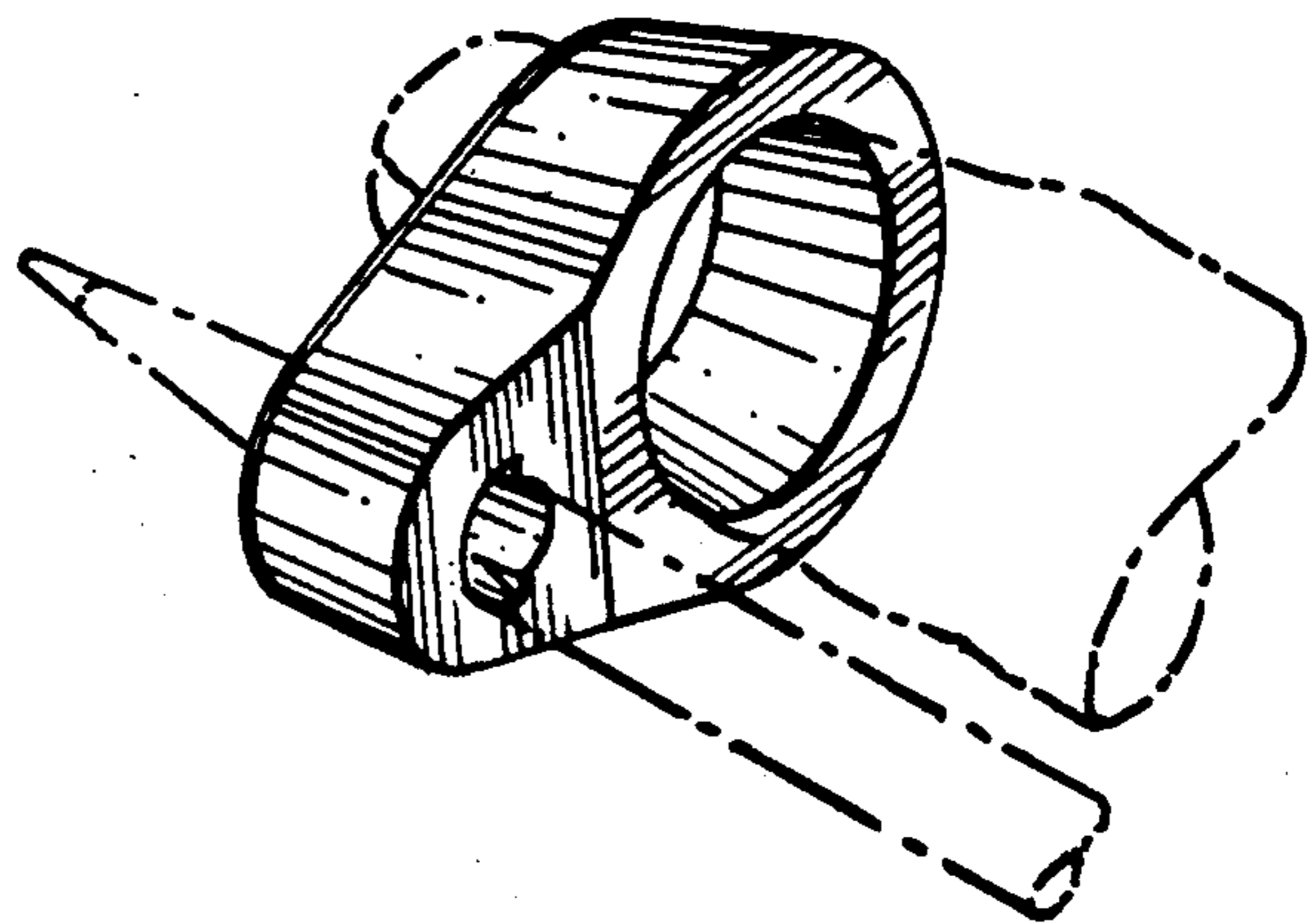

Fig. 8.